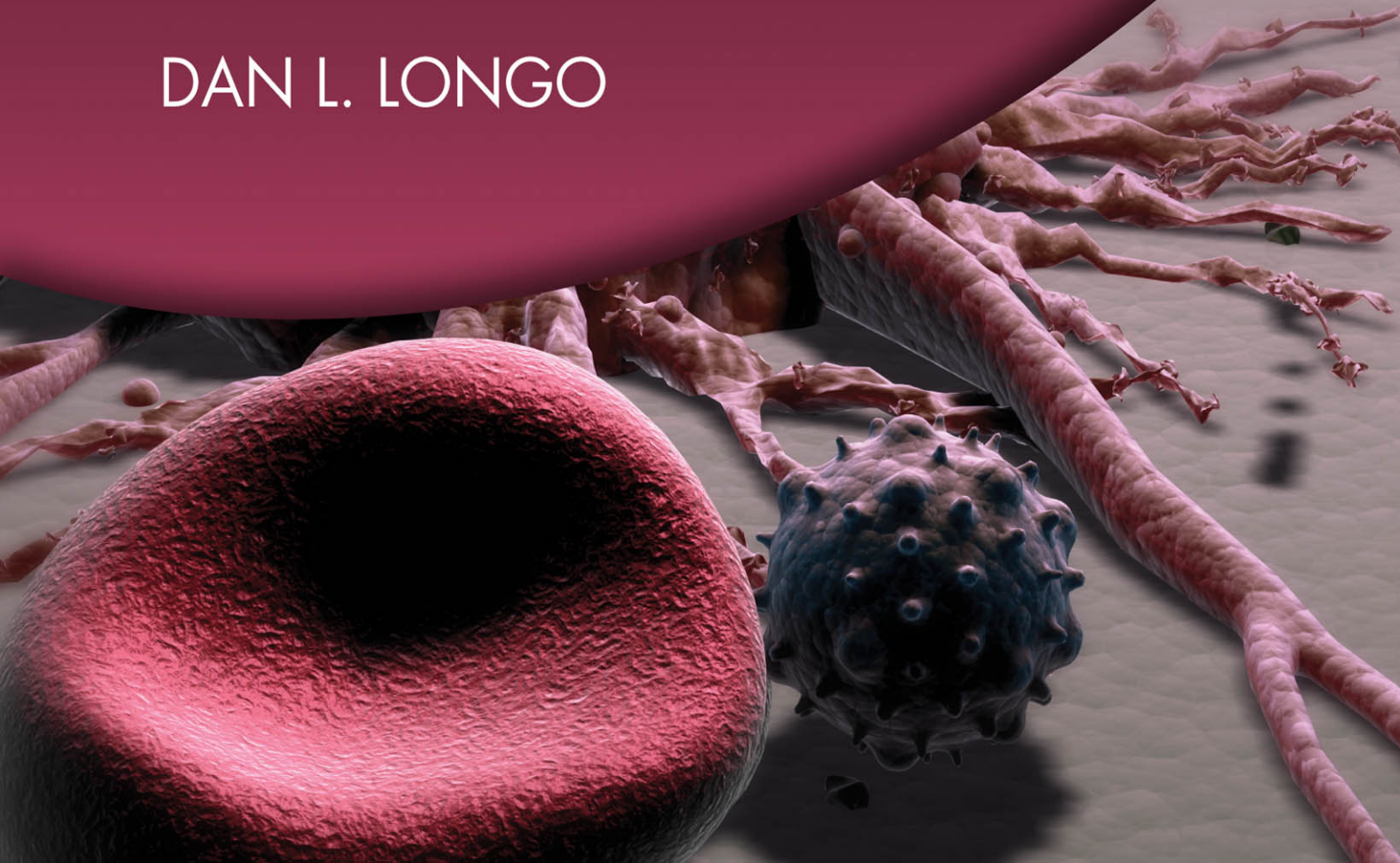




# HARRISON'S

## Hematology and Oncology

DAN L. LONGO





**HARRISON'S**  
Hematology  
and Oncology

Derived from Harrison's Principles of Internal Medicine, 17th Edition

## Editors

### **ANTHONY S. FAUCI, MD**

Chief, Laboratory of Immunoregulation;  
Director, National Institute of Allergy and Infectious Diseases,  
National Institutes of Health, Bethesda

### **EUGENE BRAUNWALD, MD**

Distinguished Hersey Professor of Medicine,  
Harvard Medical School; Chairman, TIMI Study Group,  
Brigham and Women's Hospital, Boston

### **DENNIS L. KASPER, MD**

William Ellery Channing Professor of Medicine, Professor of  
Microbiology and Molecular Genetics, Harvard Medical School;  
Director, Channing Laboratory, Department of Medicine,  
Brigham and Women's Hospital, Boston

### **STEPHEN L. HAUSER, MD**

Robert A. Fishman Distinguished Professor and Chairman,  
Department of Neurology, University of California, San Francisco

### **DAN L. LONGO, MD**


Scientific Director, National Institute on Aging,  
National Institutes of Health,  
Bethesda and Baltimore

### **J. LARRY JAMESON, MD, PhD**

Professor of Medicine;  
Vice President for Medical Affairs  
and Lewis Landsberg Dean,  
Northwestern University Feinberg  
School of Medicine, Chicago

### **JOSEPH LOSCALZO, MD, PhD**

Hersey Professor of Theory and Practice of Medicine,  
Harvard Medical School; Chairman, Department of Medicine;  
Physician-in-Chief, Brigham and Women's Hospital, Boston



# HARRISON'S Hematology and Oncology

**Editor**

**Dan L. Longo, MD**

Scientific Director, National Institute on Aging,  
National Institutes of Health, Bethesda and Baltimore

 **Medical**

New York Chicago San Francisco Lisbon London Madrid Mexico City  
Milan New Delhi San Juan Seoul Singapore Sydney Toronto

Copyright © 2010 by The McGraw-Hill Companies, Inc. All rights reserved. Except as permitted under the United States Copyright Act of 1976, no part of this publication may be reproduced or distributed in any form or by any means, or stored in a database or retrieval system, without the prior written permission of the publisher.

ISBN: 978-0-07-166336-6

MHID: 0-07-166336-3

The material in this eBook also appears in the print version of this title: ISBN: 978-0-07-166335-9, MHID: 0-07-166335-5.

All trademarks are trademarks of their respective owners. Rather than put a trademark symbol after every occurrence of a trademarked name, we use names in an editorial fashion only, and to the benefit of the trademark owner, with no intention of infringement of the trademark. Where such designations appear in this book, they have been printed with initial caps.

McGraw-Hill eBooks are available at special quantity discounts to use as premiums and sales promotions, or for use in corporate training programs. To contact a representative please e-mail us at [bulksales@mcgraw-hill.com](mailto:bulksales@mcgraw-hill.com).

This book was set in Bembo by Glyph International. The editors were James Shanahan and Kim J. Davis. The production supervisor was Catherine H. Saggese. Project management was provided by Arushi Chawla of Glyph International. The cover design was by Thomas DePierro. Cover, section, and chapter opener illustrations © MedicalRF.com. All rights reserved.

#### TERMS OF USE

This is a copyrighted work and The McGraw-Hill Companies, Inc. (“McGrawHill”) and its licensors reserve all rights in and to the work. Use of this work is subject to these terms. Except as permitted under the Copyright Act of 1976 and the right to store and retrieve one copy of the work, you may not decompile, disassemble, reverse engineer, reproduce, modify, create derivative works based upon, transmit, distribute, disseminate, sell, publish or sublicense the work or any part of it without McGraw-Hill’s prior consent. You may use the work for your own noncommercial and personal use; any other use of the work is strictly prohibited. Your right to use the work may be terminated if you fail to comply with these terms.

THE WORK IS PROVIDED “AS IS.” MCGRAW-HILL AND ITS LICENSORS MAKE NO GUARANTEES OR WARRANTIES AS TO THE ACCURACY, ADEQUACY OR COMPLETENESS OF OR RESULTS TO BE OBTAINED FROM USING THE WORK, INCLUDING ANY INFORMATION THAT CAN BE ACCESSED THROUGH THE WORK VIA HYPERLINK OR OTHERWISE, AND EXPRESSLY DISCLAIM ANY WARRANTY, EXPRESS OR IMPLIED, INCLUDING BUT NOT LIMITED TO IMPLIED WARRANTIES OF MERCHANTABILITY OR FITNESS FOR A PARTICULAR PURPOSE. McGraw-Hill and its licensors do not warrant or guarantee that the functions contained in the work will meet your requirements or that its operation will be uninterrupted or error free. Neither McGraw-Hill nor its licensors shall be liable to you or anyone else for any inaccuracy, error or omission, regardless of cause, in the work or for any damages resulting therefrom. McGraw-Hill has no responsibility for the content of any information accessed through the work. Under no circumstances shall McGraw-Hill and/or its licensors be liable for any indirect, incidental, special, punitive, consequential or similar damages that result from the use of or inability to use the work, even if any of them has been advised of the possibility of such damages. This limitation of liability shall apply to any claim or cause whatsoever whether such claim or cause arises in contract, tort or otherwise.

# CONTENTS

<b>Contributors</b> . . . . .	ix
<b>Preface</b> . . . . .	xiii

## SECTION I THE CELLULAR BASIS OF HEMATOPOIESIS

<b>1</b> Hematopoietic Stem Cells . . . . .	2
<i>David T. Scadden, Dan L. Longo</i>	

## SECTION II CARDINAL MANIFESTATIONS OF HEMATOLOGIC DISEASE

<b>2</b> Anemia and Polycythemia . . . . .	10
<i>John W. Adamson, Dan L. Longo</i>	
<b>3</b> Bleeding and Thrombosis. . . . .	22
<i>Barbara A. Konkle</i>	
<b>4</b> Enlargement of Lymph Nodes and Spleen . . . . .	32
<i>Patrick H. Henry, Dan L. Longo</i>	
<b>5</b> Disorders of Granulocytes and Monocytes . . . . .	42
<i>Steven M. Holland, John I. Gallin</i>	
<b>6</b> Atlas of Hematology and Analysis of Peripheral Blood Smears . . . . .	57
<i>Dan L. Longo</i>	

## SECTION III ANEMIAS

<b>7</b> Iron Deficiency and Other Hypoproliferative Anemias . . . . .	70
<i>John W. Adamson</i>	
<b>8</b> Disorders of Hemoglobin . . . . .	81
<i>Edward J. Benz, Jr.</i>	
<b>9</b> Megaloblastic Anemias. . . . .	95
<i>A. Victor Hoffbrand</i>	
<b>10</b> Hemolytic Anemias and Anemia Due to Acute Blood Loss . . . . .	110
<i>Lucio Luzzatto</i>	

<b>11</b> Aplastic Anemia, Myelodysplasia, and Related Bone Marrow Failure Syndromes . . . . .	128
<i>Neal S. Young</i>	

<b>12</b> Transfusion Biology and Therapy . . . . .	143
<i>Jeffery S. Dzieczkowski, Kenneth C. Anderson</i>	

## SECTION IV MYELOPROLIFERATIVE DISORDERS

<b>13</b> Polycythemia Vera and Other Myeloproliferative Diseases . . . . .	154
<i>Jerry L. Spivak</i>	

## SECTION V HEMATOLOGIC MALIGNANCIES

<b>14</b> Acute and Chronic Myeloid Leukemia . . . . .	166
<i>Meir Wetzler, John C. Byrd, Clara D. Bloomfield</i>	
<b>15</b> Malignancies of Lymphoid Cells. . . . .	182
<i>Dan L. Longo</i>	
<b>16</b> Plasma Cell Disorders . . . . .	205
<i>Nikhil C. Munshi, Dan L. Longo, Kenneth C. Anderson</i>	
<b>17</b> Amyloidosis . . . . .	217
<i>David C. Seldin, Martha Skinner</i>	

## SECTION VI DISORDERS OF HEMOSTASIS

<b>18</b> Disorders of Platelets and Vessel Wall . . . . .	224
<i>Barbara A. Konkle</i>	
<b>19</b> Coagulation Disorders . . . . .	235
<i>Valder Arruda, Katherine A. High</i>	
<b>20</b> Venous Thrombosis . . . . .	246
<i>F. R. Rosendaal, H. R. Büller</i>	
<b>21</b> Pulmonary Thromboembolism. . . . .	253
<i>Samuel Z. Goldhaber</i>	
<b>22</b> Antiplatelet, Anticoagulant, and Fibrinolytic Drugs. . . . .	264
<i>Jeffrey I. Weitz</i>	

## SECTION VII BIOLOGY OF CANCER

- 23** Cancer Genetics . . . . . 284  
*Pat J. Morin, Jeffrey M. Trent, Francis S. Collins,  
Bert Vogelstein*
- 24** Cancer Cell Biology and Angiogenesis . . . . . 294  
*Robert G. Fenton, Dan L. Longo*

## SECTION VIII PRINCIPLES OF CANCER PREVENTION AND TREATMENT

- 25** Approach to the Patient with Cancer . . . . . 320  
*Dan L. Longo*
- 26** Prevention and Early Detection of Cancer . . . . . 332  
*Otis Webb Brawley, Barnett S. Kramer*
- 27** Principles of Cancer Treatment . . . . . 343  
*Edward A. Sausville, Dan L. Longo*
- 28** Infections in Patients with Cancer . . . . . 374  
*Robert Finberg*
- 29** Hematopoietic Cell Transplantation . . . . . 388  
*Frederick R. Appelbaum*
- 30** Palliative and End-of-Life Care . . . . . 398  
*Ezekiel J. Emanuel, Joshua Hauser,  
Linda L. Emanuel*

## SECTION IX NEOPLASTIC DISORDERS

- 31** Cancer of the Skin . . . . . 422  
*Arthur J. Sober, Hensin Tsao, Carl V. Washington, Jr.*
- 32** Head and Neck Cancer . . . . . 433  
*Everett E. Vokes*
- 33** Neoplasms of the Lung . . . . . 439  
*John D. Minna, Joan H. Schiller*
- 34** Breast Cancer . . . . . 459  
*Marc E. Lippman*
- 35** Gastrointestinal Tract Cancer . . . . . 472  
*Robert J. Mayer*
- 36** Tumors of the Liver and Biliary Tree . . . . . 489  
*Brian I. Carr*

- 37** Pancreatic Cancer . . . . . 499  
*Yu Jo Chua, David Cunningham*
- 38** Bladder and Renal Cell Carcinomas . . . . . 504  
*Howard I. Scher, Robert J. Motzer*
- 39** Benign and Malignant Diseases of the Prostate . . . 511  
*Howard I. Scher*
- 40** Testicular Cancer . . . . . 524  
*Robert J. Motzer, George J. Bosl*
- 41** Gynecologic Malignancies . . . . . 530  
*Robert C. Young*
- 42** Soft Tissue and Bone Sarcomas  
and Bone Metastases . . . . . 540  
*Shreyaskumar R. Patel, Robert S. Benjamin*
- 43** Primary and Metastatic Tumors  
of the Nervous System . . . . . 547  
*Stephen M. Sagar, Mark A. Israel*
- 44** Carcinoma of Unknown Primary . . . . . 562  
*Gauri R. Varadhachary, James L. Abbruzzese*

## SECTION X ENDOCRINE NEOPLASIA

- 45** Thyroid Cancer . . . . . 570  
*J. Larry Jameson, Anthony P. Weetman*
- 46** Endocrine Tumors of the Gastrointestinal  
Tract and Pancreas . . . . . 578  
*Robert T. Jensen*
- 47** Multiple Endocrine Neoplasia . . . . . 597  
*Camilo Jimenez, Robert F. Gagel*
- 48** Pheochromocytoma and Adrenocortical  
Carcinoma . . . . . 609  
*Hartmut P. H. Neumann, Dan L. Longo*

## SECTION XI REMOTE EFFECTS OF CANCER

- 49** Paraneoplastic Syndromes: Endocrinologic/  
Hematologic . . . . . 622  
*J. Larry Jameson, Bruce E. Johnson*
- 50** Paraneoplastic Neurologic Syndromes . . . . . 631  
*Josep Dalmau, Myrna R. Rosenfeld*

SECTION XII  
**ONCOLOGIC EMERGENCIES  
AND LATE COMPLICATIONS**

- 51** Oncologic Emergencies . . . . . 642  
*Rasim Gucalp, Janice P. Dutcher*
- 52** Late Consequences of Cancer  
and Its Treatment . . . . . 657  
*Michael C. Perry, Dan L. Longo*

**Appendix**

- Laboratory Values of Clinical  
Importance . . . . . 663  
*Alexander Kratz, Michael A. Pesce,  
Daniel J. Fink*

**Review and Self-Assessment** . . . . . 685

- Charles Wiener, Gerald Bloomfield, Cynthia D. Brown,  
Joshua Schiffer, Adam Spivak*

**Index** . . . . . 731



*This page intentionally left blank*

# CONTRIBUTORS

Numbers in brackets refer to the chapter(s) written or co-written by the contributor.

**JAMES L. ABBRUZZESE, MD**

Chair and Professor, GI Medical Oncology; Associate Medical Director, GI and Endoscope Center, Ofc/EVP; University of Texas, MD Anderson Cancer Center, Houston [44]

**JOHN W. ADAMSON, MD**

Clinical Professor of Medicine, UCSD Cancer Center, Hematology/Oncology, University of California at San Diego, La Jolla [2, 7]

**KENNETH C. ANDERSON, MD**

Kraft Family Professor of Medicine, Harvard Medical School; Chief, Division of Hematologic Neoplasia, Dana-Farber Cancer Institute, Boston [12, 16]

**FREDERICK R. APPELBAUM, MD**

Member and Director, Clinical Research Division, Fred Hutchinson Cancer Research Center; Professor and Head, Division of Medical Oncology, University of Washington School of Medicine, Seattle [29]

**VALDER ARRUDA, MD, PhD**

Associate Professor of Pediatrics, University of Pennsylvania School of Medicine, Division of Hematology, The Children's Hospital of Philadelphia, Philadelphia [19]

**ROBERT S. BENJAMIN, MD**

Professor of Medicine; Chairman, Department of Sarcoma Medical Oncology, The University of Texas MD Anderson Cancer Center, Houston [42]

**EDWARD J. BENZ, JR., MD**

Richard and Susan Smith Professor of Medicine; Professor of Pediatrics; Professor of Pathology, Harvard Medical School; President and CEO, Dana-Farber Cancer Institute; Director, Dana-Farber/Harvard Cancer Center, Boston [8]

**CLARA D. BLOOMFIELD, MD**

Distinguished University Professor; William G. Pace III Professor of Cancer Research, Cancer Scholar and Senior Advisor, The Ohio State University Comprehensive Cancer Center and Arthur G. James Cancer Hospital and Richard J. Solove Research Institute, Columbus [14]

**GERALD BLOOMFIELD, MD, MPH**

Department of Internal Medicine, The Johns Hopkins University School of Medicine, Baltimore [Review and Self-Assessment]

**GEORGE J. BOSL, MD**

Chairman, Department of Medicine, Memorial Sloan-Kettering Cancer Center; Professor of Medicine, Joan and Sanford I Weill Medical College of Cornell University, New York [40]

**OTIS WEBB BRAWLEY, MD**

Professor, Hematology, Oncology, Medicine & Epidemiology, Emory University; Chief Medical Officer, American Cancer Society, Atlanta [26]

**CYNTHIA D. BROWN, MD**

Department of Internal Medicine, The Johns Hopkins University School of Medicine, Baltimore [Review and Self-Assessment]

**HARRY R. BÜLLER, MD**

Professor of Medicine; Chairman, Department of Vascular Medicine, Academic Medical Center, Amsterdam [20]

**JOHN C. BYRD, MD**

D. Warren Brown Professor of Leukemia Research Professor; Co-Director of Hematologic Malignancies, Division of Hematology and Oncology, Arthur G. James Cancer Hospital, Columbus [14]

**BRIAN I. CARR, MD, PhD**

Professor of Medicine, Thomas Jefferson University; Director of the Liver Tumor Program, Kimmel Cancer Center, Philadelphia [36]

**YU JO CHUA, MBBS**

Research Fellow (Medical Oncology), Royal Marsden Hospital, London [37]

**FRANCIS S. COLLINS, MD, PhD**

Director, National Human Genome Research Institute, National Institutes of Health, Bethesda [23]

**DAVID CUNNINGHAM, MD**

Professor of Cancer Medicine, Institute of Cancer Research; Consultant Medical Oncologist, Head of Gastrointestinal Unit, Royal Marsden Hospital, London [37]

**JOSEP DALMAU, MD, PhD**

Professor of Neurology, Division Neuro-Oncology, Department of Neurology, Philadelphia [50]

**JANICE P. DUTCHER, MD**

Professor, New York Medical College; Associate Director, Our Lady of Mercy Cancer Center, Bronx [51]

**JEFFERY S. DZIECZKOWSKI, MD**

Physician, St. Alphonsus Regional Medical Center; Medical Director, Coagulation Clinic, Saint Alphonsus Medical Group/Internal Medicine, Boise [12]

**EZEKIEL J. EMANUEL, MD, PhD**

Chair, Department of Bioethics, The Warren G. Magnuson Clinical Center, National Institutes of Health, Bethesda [30]

**LINDA L. EMANUEL, MD, PhD**

Buehler Professor of Medicine; Director, Buehler Center on Aging, Health & Society, Northwestern University Feinberg School of Medicine, Chicago [30]

**ROBERT G. FENTON, MD, PhD**

Staff Clinician, National Institute on Aging, National Institutes of Health, Baltimore [24]

**ROBERT FINBERG, MD**

Professor and Chair, Department of Medicine, University of Massachusetts Medical School, Worcester [28]

**DANIEL J. FINK,<sup>†</sup> MD, MPH**

Associate Professor of Clinical Pathology, College of Physicians and Surgeons, Columbia University, New York [Appendix]

---

<sup>†</sup>Deceased.

**ROBERT F. GAGEL, MD**

Professor of Medicine and Head, Division of Internal Medicine, University of Texas MD Anderson Cancer Center, Houston [47]

**JOHN I. GALLIN, MD**

Director, The Warren G. Magnuson Clinical Center, National Institutes of Health, Bethesda [5]

**SAMUEL Z. GOLDHABER, MD**

Professor of Medicine, Harvard Medical School; Director, Venous Thromboembolism Research Group, Director, Anticoagulation Service, and Senior Staff Cardiologist, Department of Medicine, Brigham and Women's Hospital, Boston [21]

**RASIM GUCALP, MD**

Professor of Clinical Medicine, Albert Einstein College of Medicine, Montefiore Medical Center, Bronx [51]

**JOSHUA HAUSER, MD**

Assistant Professor of Medicine and Palliative Care; Assistant Director of the Beuler Center on Aging, Northwestern University, Chicago [30]

**PATRICK H. HENRY, MD**

Adjunct Clinical Professor of Medicine, University of Iowa, Iowa City [4]

**KATHERINE A. HIGH, MD**

William H. Bennett Professor of Pediatrics, University of Pennsylvania School of Medicine; Investigator, Howard Hughes Medical Institute, The Children's Hospital of Philadelphia, Philadelphia [19]

**A. VICTOR HOFFBRAND, DM**

Emeritus Professor of Haematology, Royal Free and University College, London [9]

**STEVEN M. HOLLAND, MD**

Senior Investigator and Head, Immunopathogenesis Unit, Clinical Pathophysiology Section, Laboratory of Host Defenses, National Institute of Allergy and Infectious Diseases, National Institutes of Health, Bethesda [5]

**MARK A. ISRAEL, MD**

Professor of Pediatrics and Genetics, Dartmouth Medical School; Director, Norris Cotton Cancer Center, Dartmouth-Hitchcock Medical Center, Lebanon [43]

**J. LARRY JAMESON, MD, PhD**

Professor of Medicine; Vice President for Medical Affairs and Lewis Landsberg Dean, Northwestern University Feinberg School of Medicine, Chicago [45, 49]

**ROBERT T. JENSEN, MD**

Chief, Digestive Diseases Branch, National Institute of Diabetes, Digestive and Kidney Diseases, National Institutes of Health, Bethesda [46]

**CAMILO JIMENEZ, MD**

Assistant Professor, Department of Endocrine Neoplasia & Hormonal Disorders, The University of Texas, MD Cancer Center, Houston [47]

**BRUCE E. JOHNSON, MD**

Director, Lowe Center for Thoracic Oncology, Department of Medical Oncology; Dana-Farber Cancer Institute, Department of Medicine, Brigham and Women's Hospital; Professor of Medicine, Harvard Medical School, Boston [49]

**BARBARA A. KONKLE, MD**

Professor of Medicine and Hematology/Oncology, University of Pennsylvania; Director, Penn Comprehensive Hemophilia and Thrombosis Program, Philadelphia [3, 18]

**BARNETT S. KRAMER, MD, MPH**

Associate Director for Disease Prevention, Office of the Director, National Institutes of Health, Bethesda [26]

**ALEXANDER KRATZ, MD, PhD, MPH**

Assistant Professor of Clinical Pathology, Columbia University College of Physicians and Surgeons; Associate Director, Core Laboratory, Columbia University Medical Center, New York-Presbyterian Hospital; Director, Allen Pavilion Laboratory, New York [Appendix]

**MARC E. LIPPMAN, MD**

Professor and Chair, Department of Medicine, University of Miami Leonard M. Miller School of Medicine, Miami [34]

**DAN L. LONGO, MD**

Scientific Director, National Institute on Aging, National Institutes of Health, Bethesda and Baltimore [1, 2, 4, 6, 15, 16, 24, 25, 27, 48, 52]

**LUCIO LUZZATTO, MD, PhD**

Professor of Hematology, University of Florence; Scientific Director, Istituto Toscano Tumori (ITT), Firenze, Italy [10]

**ROBERT J. MAYER, MD**

Stephen B. Kay Family Professor of Medicine, Harvard Medical School, Dana-Farber Cancer Institute, Boston [35]

**JOHN D. MINNA, MD**

Professor, Internal Medicine and Pharmacology; Director, Hamon Center for Therapeutic Oncology Research, University of Texas Southwestern Medical Center, Dallas [33]

**PAT J. MORIN, PhD**

Senior Investigator, Laboratory of Cellular and Molecular Biology, National Institute on Aging, National Institutes of Health, Bethesda [23]

**ROBERT J. MOTZER, MD**

Attending Physician, Department of Medicine, Memorial Sloan-Kettering Cancer Center; Professor of Medicine, Weill Medical College of Cornell University, New York [38, 40]

**NIKHIL C. MUNSHI, MD**

Associate Director, Jerome Lipper Multiple Myeloma Center, Dana-Farber Cancer Institute, Boston VA Health Care System; Associate Professor, Harvard Medical School, Boston [16]

**HARTMUT P. H. NEUMANN, MD**

Head, Section Preventative Medicine, Department of Nephrology and General Medicine, Albert-Ludwigs-University of Freiburg, Germany [48]

**SHREYASKUMAR R. PATEL, MD**

Professor of Medicine, Deputy Chairman, Department of Sarcoma Medical Oncology, University of Texas, Houston [42]

**MICHAEL C. PERRY, MD, MS**

Professor and Director, Division of Hematology/Medical Oncology, Department of Internal Medicine, Nellie B. Smith Chair of Oncology, University of Missouri-Columbia School of Medicine, Columbia [52]

**MICHAEL A. PESCE, PhD**

Clinical Professor of Pathology, Columbia University College of Physicians and Surgeons; Director of Specialty Laboratory, New York Presbyterian Hospital, Columbia University Medical Center, New York [Appendix]

**FRITS R. ROSENDAAL, MD**

Professor of Clinical Epidemiology; Chairman, Department of Clinical Epidemiology, and Department of Thrombosis and Hemostasis, Leiden University Medical Center, The Netherlands [20]

**MYRNA R. ROSENFELD, MD, PhD**

Associate Professor of Neurology, Division Neuro-Oncology, Department of Neurology, University of Pennsylvania, Philadelphia [50]

**STEPHEN M. SAGAR, MD**

Professor of Neurology, Case Western Reserve School of Medicine; Director of Neuro-Oncology, Ireland Cancer Center, University Hospitals of Cleveland, Cleveland [43]

**EDWARD A. SAUSVILLE, MD, PhD**

Professor of Medicine; Associate Director for Clinical Research, Marlene & Stewart Greenebaum Cancer Center, University of Maryland, Baltimore [27]

**DAVID T. SCADDEN, MD**

Gerald and Darlene Jordan Professor of Medicine, Harvard University; Co-Chair, Department of Stem Cell and Regenerative Biology, Harvard University, Boston [1]

**HOWARD I. SCHER, MD**

Professor of Medicine, Weill Medical College of Cornell University; D. Wayne Calloway Chair in Urologic Oncology; Chief, Genitourinary Oncology Service, Memorial Sloan-Kettering Cancer Center, New York [38, 39]

**JOSHUA SCHIFFER, MD**

Department of Internal Medicine, The Johns Hopkins University School of Medicine, Baltimore [Review and Self-Assessment]

**JOAN H. SCHILLER, MD**

Professor of Medicine and Hematology/Oncology, University of Texas Southwestern Medical School; Simmons Comprehensive Cancer Center, Dallas [33]

**DAVID C. SELDIN, MD, PhD**

Professor of Medicine and Microbiology; Director, Amyloid Treatment and Research Program Section of Hematology-Oncology, Department of Medicine, Boston University School of Medicine and Boston Medical Center, Boston [17]

**MARTHA SKINNER, MD**

Professor of Medicine, Boston University School of Medicine; Director, Special Projects, Amyloid Treatment and Research Program, Boston [17]

**ARTHUR J. SOBER, MD**

Professor, Department of Dermatology, Harvard Medical School; Associate Chief, Department of Dermatology, Massachusetts General Hospital, Boston [31]

**ADAM SPIVAK, MD**

Department of Internal Medicine, The Johns Hopkins University School of Medicine, Baltimore [Review and Self-Assessment]

**JERRY L. SPIVAK, MD**

Professor of Medicine, The Johns Hopkins University School of Medicine; Attending Physician, Johns Hopkins Hospital, Baltimore [13]

**JEFFREY M. TRENT, PhD**

President and Scientific Director, Translational Genomics Research Institute, Phoenix [23]

**HENSIN TSAO, MD**

Assistant Professor of Dermatology, Harvard Medical School; Clinical Director, Melanoma Genetics Program, Massachusetts General Hospital, Boston [31]

**GAURI R. VARADHACHARY, MD**

Associate Professor, Department of Gastrointestinal Medical Oncology, University of Texas MD Anderson Cancer Center, Houston [44]

**BERT VOGELSTEIN, MD**

Director, Ludwig Center for Cancer Genetics & Therapeutics; Investigator, Howard Hughes Medical Institute; Clayton Professor for Oncology & Pathology, The Johns Hopkins University School of Medicine, Baltimore [23]

**EVERETT E. VOKES, MD**

Director, Section of Hematology/Oncology; Vice Chairman for Clinical Research, Department of Medicine; Deputy Director, Cancer Research Center; John E. Ulmann Professor of Medicine and Radiation and Cellular Oncology, University of Chicago School of Medicine, Chicago [32]

**CARL V. WASHINGTON, JR., MD**

Associate Professor of Dermatology, Emory University School of Medicine; Co-Director, Dermatologic Surgery Unit, The Emory Clinic, Atlanta [31]

**ANTHONY P. WEETMAN, MD, DSc**

Professor of Medicine and Dean of the School of Medicine and Biomedical Sciences, University of Sheffield, Sheffield, United Kingdom [45]

**JEFFREY I. WEITZ, MD**

Professor of Medicine and Biochemistry, McMaster University; Director, Henderson Research Centre, Heart and Stroke Foundation/J. Fraser Mustard Chair in Cardiovascular Research; Canada Research Chair (Tier 1) in Thrombosis; Career Investigator, Heart and Stroke Foundation of Canada [22]

**MEIR WETZLER, MD**

Professor of Medicine, Roswell Park Cancer Institute, Buffalo [14]

**CHARLES WIENER, MD**

Professor of Medicine and Physiology; Vice Chair, Department of Medicine; Director, Osler Medical Training Program, The Johns Hopkins University School of Medicine, Baltimore [Review and Self-Assessment]

**NEAL S. YOUNG, MD**

Chief, Hematology Branch, National Heart, Lung, and Blood Institute, National Institutes of Health, Bethesda [11]

**ROBERT C. YOUNG, MD**

Chancellor, Fox Chase Cancer Center, Philadelphia [41]

*This page intentionally left blank*

## PREFACE

*Harrison's Principles of Internal Medicine* has a long and distinguished tradition in the field of hematology. Maxwell Wintrobe, whose work actually established hematology as a distinct subspecialty of medicine, was a founding editor of the book and participated in the first seven editions, taking over for Tinsley Harrison as editor-in-chief on the sixth and seventh editions. Wintrobe, born in 1901, began his study of blood in earnest in 1927 as an assistant in medicine at Tulane University in New Orleans. He continued his studies at Johns Hopkins from 1930 to 1943 and moved to the University of Utah in 1943, where he remained until his death in 1986. He invented a variety of the measures that are routinely used to characterize red blood cell abnormalities, including the hematocrit, the red cell indices, and erythrocyte sedimentation rate, and defined the normal and abnormal values for these parameters, among many other important contributions in a 50-year career.

Oncology began as a subspecialty much later. It came to life as a specific subdivision within hematology. A subset of hematologists with a special interest in hematologic malignancies began working with chemotherapeutic agents to treat leukemia and lymphoma in the mid-1950s and early 1960s. As new agents were developed and the principles of clinical trial research were developed, the body of knowledge of oncology began to become larger and mainly independent from hematology. Informed by the laboratory study of cancer biology and an expansion in focus beyond hematologic neoplasms to tumors of all organ systems, oncology developed as a separable discipline from hematology. This separation was also fueled by the expansion of the body of knowledge about clotting and its disorders, which became a larger part of hematology.

In most academic medical centers, hematology and oncology remain connected. However, conceptual distinctions between hematology and oncology have been made. Differences are reinforced by separate fellowship training programs (although many joint training programs remain), separate board certification examinations, separate professional organizations, and separate textbooks describing separate bodies of knowledge. In some academic medical centers, oncology is not merely a separate subspecialty division in a Department of Medicine but is an entirely distinct department in the medical school with the same standing as the Department of Medicine. Economic forces are also at work to separate hematology and oncology.

Perhaps I am only reflecting the biases of an old dog, but I am unenthusiastic about the increasing fractionation

of medicine subspecialties. There are now invasive and noninvasive cardiologists, gastroenterologists who do and others who do not use endoscopes, organ-focused subspecialists (diabetologists, thyroidologists) instead of organ system-focused subspecialists (endocrinologists). At a time when the body of knowledge that must be mastered is increasing dramatically, the duration of training has not been increased to accommodate the additional learning that is necessary to become highly skilled. Extraordinary attention has been focused on the hours that trainees work. Apparently, the administrators are more concerned about undocumented adverse effects of every third night call on trainees than they are about the well-documented adverse effects on patients of frequent handoffs of patient responsibility to multiple caregivers.

Despite the sub-sub-specialization that is pervasive in modern medicine, students, trainees, general internists, family medicine physicians, and specialists in nonmedicine specialties still require access to information in hematology and oncology that can assist them in meeting the needs of their patients. Given the paucity of single sources of integrated information on hematology and oncology, the editors of *Harrison's Principles of Internal Medicine* decided to pull together the chapters in the "mother book" related to hematology and oncology and bind them together in a subspecialty themed book called *Harrison's Hematology and Oncology*.

The book contains 52 chapters organized into 12 sections: (I) The Cellular Basis of Hematopoiesis, (II) Cardinal Manifestations of Hematologic Diseases, (III) Anemias, (IV) Myeloproliferative Disorders, (V) Hematologic Malignancies, (VI) Disorders of Hemostasis, (VII) Biology of Cancer, (VIII) Principles of Cancer Prevention and Treatment, (IX) Neoplastic Disorders, (X) Endocrine Neoplasia, (XI) Remote Effects of Cancer, and (XII) Oncologic Emergencies and Late Complications.

The chapters have been written by physicians who have made seminal contributions to the body of knowledge in their areas of expertise. The information is authoritative and as current as we can make it, given the time requirements of producing books. Each chapter contains the relevant information on the genetics, cell biology, pathophysiology, and treatment of specific disease entities. In addition, separate chapters on hematopoiesis, cancer cell biology, and cancer prevention reflect the rapidly growing body of knowledge in these areas that are the underpinning of our current concepts of diseases in hematology and oncology. In addition to the factual

information presented in the chapters, a section of test questions and answers is provided to reinforce important principles. A narrative explanation of what is wrong with the wrong answers should be of further value in the preparation of the reader for board examinations.

The bringing together of hematology and oncology in a single text is unusual and we hope it is useful. Like many areas of medicine, the body of knowledge relevant to the practice of hematology and oncology is expanding rapidly. New discoveries with clinical impact are

being made at an astounding rate; nearly constant effort is required to try to keep pace. It is our hope that this book is helpful to you in the struggle to master the daunting volume of new findings relevant to the care of your patients.

We are extremely grateful to Kim Davis and James Shanahan at McGraw-Hill for their invaluable assistance in the preparation of this book.

Dan L. Longo, MD

## NOTICE

Medicine is an ever-changing science. As new research and clinical experience broaden our knowledge, changes in treatment and drug therapy are required. The authors and the publisher of this work have checked with sources believed to be reliable in their efforts to provide information that is complete and generally in accord with the standards accepted at the time of publication. However, in view of the possibility of human error or changes in medical sciences, neither the authors nor the publisher nor any other party who has been involved in the preparation or publication of this work warrants that the information contained herein is in every respect accurate or complete, and they disclaim all responsibility for any errors or omissions or for the results obtained from use of the information contained in this work. Readers are encouraged to confirm the information contained herein with other sources. For example and in particular, readers are advised to check the product information sheet included in the package of each drug they plan to administer to be certain that the information contained in this work is accurate and that changes have not been made in the recommended dose or in the contraindications for administration. This recommendation is of particular importance in connection with new or infrequently used drugs.

Review and self-assessment questions and answers were taken from Wiener C, Fauci AS, Braunwald E, Kasper DL, Hauser SL, Longo DL, Jameson JL, Loscalzo J (editors) Bloomfield G, Brown CD, Schiffer J, Spivak A (contributing editors). *Harrison's Principles of Internal Medicine Self-Assessment and Board Review*, 17<sup>th</sup> ed. New York, McGraw-Hill, 2008, ISBN 978-0-07-149619-3.



The global icons call greater attention to key epidemiologic and clinical differences in the practice of medicine throughout the world.



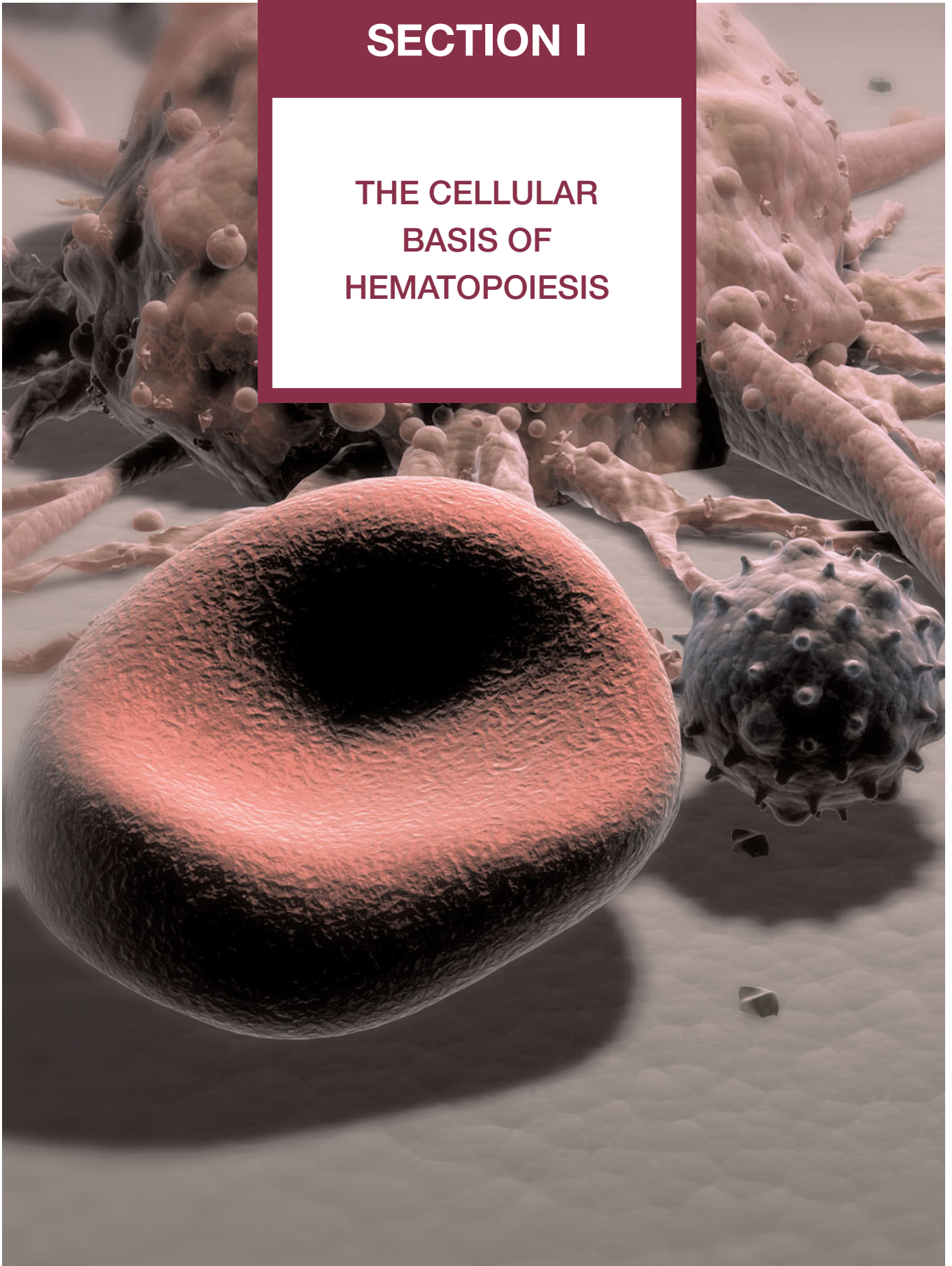
The genetic icons identify a clinical issue with an explicit genetic relationship.

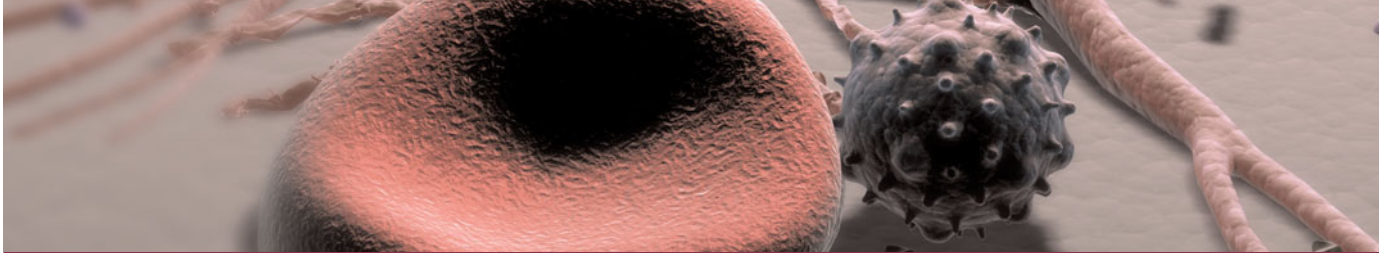


*This page intentionally left blank*

# SECTION I

## THE CELLULAR BASIS OF HEMATOPOIESIS





# CHAPTER 1

## HEMATOPOIETIC STEM CELLS

David T. Scadden ■ Dan L. Longo

- Cardinal Functions of Hematopoietic Stem Cells . . . . . 2
- Developmental Biology of Hematopoietic Stem Cells . . . . . 3
- Mobility of Hematopoietic Stem Cells . . . . . 3
- Hematopoietic Stem Cell Microenvironment . . . . . 3
- Excess Capacity of Hematopoietic Stem Cells . . . . . 4
- Hematopoietic Stem Cell Differentiation . . . . . 4
- Self-Renewal . . . . . 5
- Cancer Is Similar to an Organ with Self-Renewing Capacity . . . 7
- What Else Can Hematopoietic Stem Cells Do? . . . . . 7
- Further Readings . . . . . 7

All of the cell types in the peripheral blood and some cells in every tissue of the body are derived from hematopoietic (*hemo*, “blood”; *poiesis*, “creation”) stem cells. If the hematopoietic stem cell is damaged and can no longer function (e.g., due to the nuclear accident at Chernobyl), a person would survive 2–4 weeks in the absence of extraordinary support measures. With the clinical use of hematopoietic stem cells, tens of thousands of lives are saved each year (Chap. 29). Stem cells produce tens of billions of blood cells daily from a stem cell pool that is estimated to be only in the hundreds of thousands. How stem cells do this, how they persist for many decades despite the production demands, and how they may be better used in clinical care are important issues in medicine.

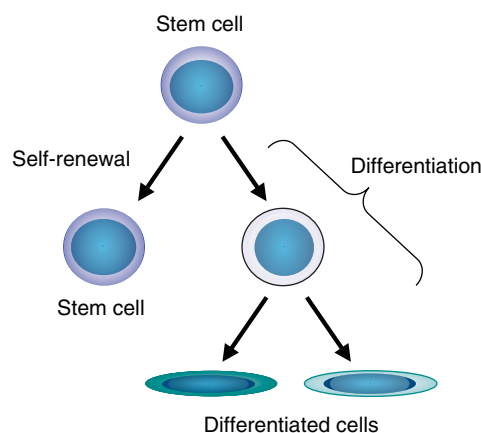
The study of blood cell production has become a paradigm for how other tissues may be organized and regulated. Basic research in hematopoiesis that includes defining stepwise molecular changes accompanying functional changes in maturing cells, aggregating cells into functional subgroups, and demonstrating hematopoietic stem cell regulation by a specialized microenvironment are concepts worked out in hematology, but they offer models for other tissues. Moreover, these concepts may not be restricted to normal tissue function but extend to malignancy. Stem cells are rare cells among a heterogeneous population of cell types, and their behavior is assessed mainly in experimental animal models involving

reconstitution of hematopoiesis. Thus much of what we know about stem cells is imprecise and based on inferences from genetically manipulated animals.

### CARDINAL FUNCTIONS OF HEMATOPOIETIC STEM CELLS

All stem cell types have two cardinal functions: self-renewal and differentiation (**Fig. 1-1**). Stem cells exist to generate, maintain, and repair tissues. They function successfully if they can replace a wide variety of shorter-lived mature cells over prolonged periods. The process of self-renewal (see later) assures that a stem cell population can be sustained over time. Without self-renewal, the stem cell pool could exhaust over time and tissue maintenance would not be possible. The process of differentiation provides the effectors of tissue function: mature cells. Without proper differentiation, the integrity of tissue function would be compromised and organ failure would ensue.

In the blood, mature cells have variable average life spans, ranging from 7 hours for mature neutrophils to a few months for red blood cells to many years for memory lymphocytes. However, the stem cell pool is the central durable source of all blood and immune cells, maintaining a capacity to produce a broad range of cells from a single cell source and yet keeping itself vigorous over

**FIGURE 1-1**

**Signature characteristics of the stem cell.** Stem cells have two essential features: the capacity to differentiate into a variety of mature cell types and the capacity for self-renewal. Intrinsic factors associated with self-renewal include expression of Bmi-1, Gfi-1, PTEN, STAT5, Tel/Atv6, p21, p18, MCL-1, Mel-18, RAE28, and HoxB4. Extrinsic signals for self-renewal include Notch, Wnt, SHH, and Tie2/Ang-1. Based mainly on murine studies, hematopoietic stem cells express the following cell surface molecules: CD34, Thy-1 (CD90), c-Kit receptor (CD117), CD133, CD164, and c-Mpl (CD110, also known as the thrombopoietin receptor).

decades of life. As an individual stem cell divides, it has the capacity to accomplish one of three division outcomes: two stem cells, two cells destined for differentiation, or one stem cell and one differentiating cell. The former two outcomes are the result of symmetric cell division, whereas the latter indicates a different outcome for the two daughter cells—an event termed *asymmetric cell division*. The relative balance for these types of outcomes may change during development and under particular kinds of demands on the stem cell pool.

## DEVELOPMENTAL BIOLOGY OF HEMATOPOIETIC STEM CELLS

During development, blood cells are produced at different sites. Initially, the yolk sac provides oxygen-carrying red blood cells, and then several sites of intraembryonic blood cell production become involved. These intraembryonic sites engage in sequential order, moving from the genital ridge at a site where the aorta, gonadal tissue, and mesonephros are emerging to the fetal liver and then, in the second trimester, to the bone marrow and spleen. As the location of stem cells changes, the relative abundance of cells they produce also changes, progressively increasing in the complexity of cell types from those simply carrying oxygen to platelets supporting a more complex vasculature to the cells of innate immunity and finally to the cells of adaptive immunity. Stem

cell proliferation remains high, even in the bone marrow, until shortly after birth, when it appears to decline dramatically. The cells in the bone marrow are thought to arrive by the bloodborne transit of cells from the fetal liver after calcification of the long bones has begun. The presence of stem cells in the circulation is not unique to a time window in development. Rather, hematopoietic stem cells appear to circulate throughout life. The time that cells spend freely circulating appears to be brief (measured in minutes in the mouse), but the cells that do circulate are functional and can be used for transplantation. The number of stem cells that circulate can be increased in a number of ways to facilitate harvest and transfer to the same or a different host.

## MOBILITY OF HEMATOPOIETIC STEM CELLS

Cells entering and exiting the bone marrow do so through a series of molecular interactions. Circulating stem cells (through CD162 and CD44) engage the lectins P- and E-selectin on the endothelial surface to slow the movement of the cells to a rolling phenotype. Stem cell integrins are then activated and accomplish firm adhesion between the stem cell and vessel wall, with a particularly important role for stem cell VCAM-1 engaging endothelial VLA-4. The chemokine CXCL12 (SDF1) interacting with stem cell CXCR4 receptors also appears to be important in the process of stem cells getting from the circulation to where they engraft in the bone marrow. This is particularly true in the developmental move from fetal liver to bone marrow; however, the role for this molecule in adults appears to be more related to retention of stem cells in the bone marrow rather the process of getting them there. Interrupting that retention process through either specific molecular blockers of the CXCR4/CXCL12 interaction, cleavage of CXCL12, or downregulation of the receptor can all result in the release of stem cells into the circulation. This process is an increasingly important aspect of recovering stem cells for therapeutic use because it has permitted the harvesting process to be done by leukapheresis rather than bone marrow punctures in the operating room. Refining our knowledge of how stem cells get into and out of the bone marrow may improve our ability to obtain stem cells and make them more efficient at finding their way to the specific sites for blood cell production, the so-called stem cell niche.

## HEMATOPOIETIC STEM CELL MICROENVIRONMENT

The concept of a specialized microenvironment, or stem cell niche, was first proposed to explain why cells derived from the bone marrow of one animal could be

4 used in transplantation and again be found in the bone marrow of the recipient. This niche is more than just a housing site for stem cells, however. It is an anatomic location where regulatory signals are provided that allow the stem cells to thrive, to expand if needed, and to provide varying amounts of descendant daughter cells. In addition, unregulated growth of stem cells may be problematic based on their undifferentiated state and self-renewal capacity. Thus the niche must also regulate the number of stem cells produced. In this manner, the niche has the dual functions of serving as a site of nurture but imposing limits for stem cells: in effect, acting as both a nest and a cage.

The niche for blood stem cells changes with each of the sites of blood production during development, but for most of human life it is located in the bone marrow. Within the bone marrow, at least two niche sites have been proposed: on trabecular bone surfaces and in the perivascular space. Stem cells may be found in both places by histologic analysis, and functional regulation has been shown at the bone surface. Specifically, bone-forming mesenchymal cells, osteoblasts, participate in hematopoietic stem cell function, affecting their location, proliferation, and number. The basis for this interaction is through a number of molecules mediating location, such as the chemokine CXCL12 (SDF1) and N-cadherin, through proliferation signals mediated by angiopoietin 1, and signaling to modulate self-renewal or survival by factors such as Notch ligands, kit ligand, and Wnts. Other bone components, such as the extracellular matrix glycoprotein, osteopontin, and the high ionic calcium found at trabecular surfaces, contribute to the unique microenvironment, or stem cell niche, on trabecular bone. This physiology has practical applications. First, medications altering niche components may have an effect on stem cell function. This has now been shown for a number of compounds, and some are being clinically tested. Second, it is now possible to assess whether the niche participates in disease states and to examine whether targeting the niche with medications may alter the outcome of certain diseases.

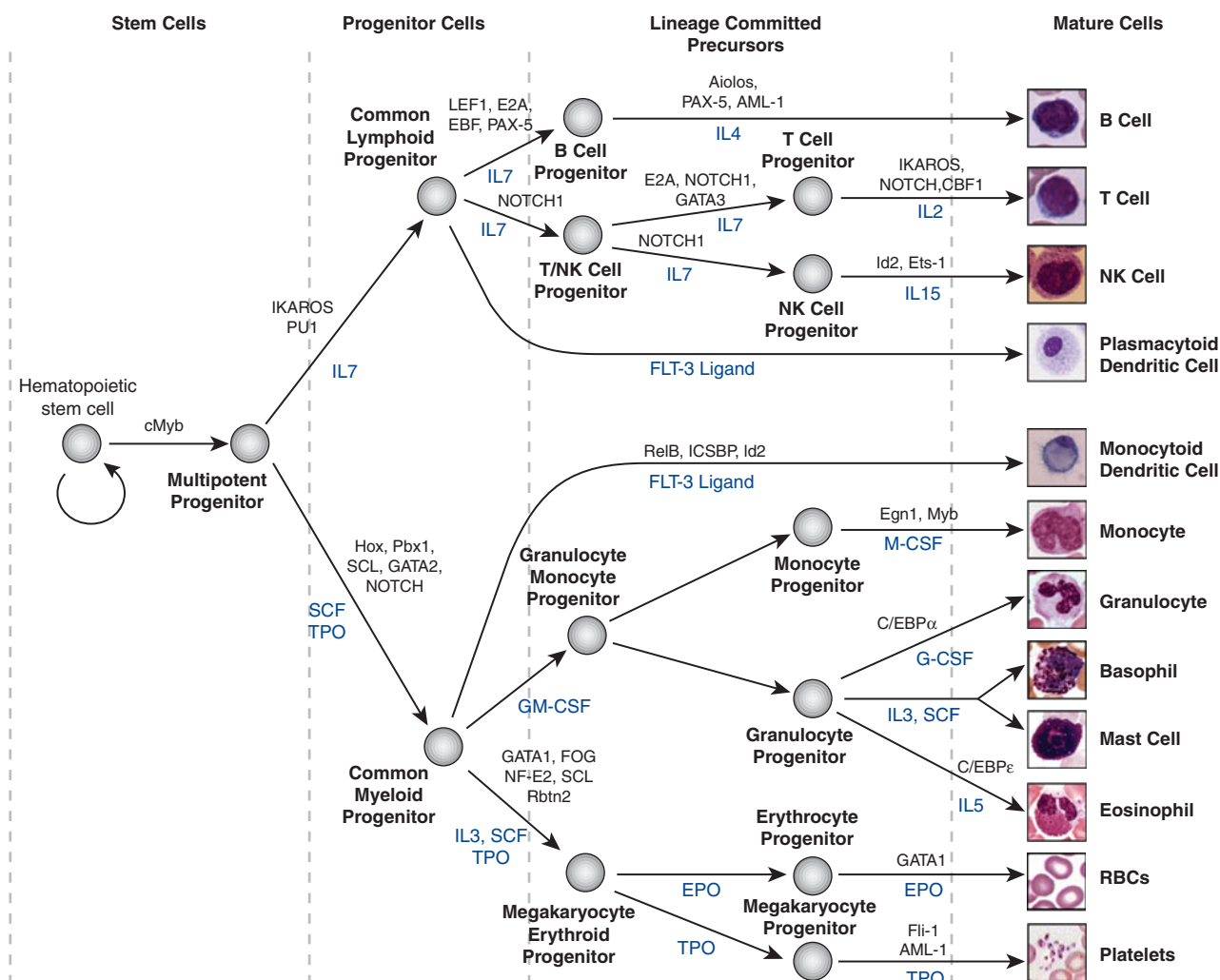
### EXCESS CAPACITY OF HEMATOPOIETIC STEM CELLS

In the absence of disease, one never runs out of hematopoietic stem cells. Indeed, serial transplantation studies in mice suggest that sufficient stem cells are present to reconstitute several animals in succession, with each animal having normal blood cell production. The fact that allogeneic stem cell transplant recipients also never run out of blood cells in their life span, which can extend for decades, argues that even the limiting numbers of stem cells provided to them are sufficient. How stem cells respond to different conditions to increase or decrease their mature cell production

remains poorly understood. Clearly, negative feedback mechanisms affect the level of production of most of the cells, leading to the normal tightly regulated blood cell counts. However, many of the regulatory mechanisms that govern production of more mature progenitor cells do not apply or apply differently to stem cells. Similarly, most of the molecules shown to be able to change the size of the stem cell pool have little effect on more mature blood cells. For example, the growth factor erythropoietin, which stimulates red blood cell production from more mature precursor cells, has no effect on stem cells. Similarly, granulocyte colony-stimulating factor drives the rapid proliferation of granulocyte precursors but does not affect cell cycling of stem cells. Rather, it changes the location of stem cells by indirect means, altering molecules such as CXCL12 that tether stem cells to their niche. Molecules shown to be important for altering the proliferation of stem cells, such as the cyclin-dependent kinase inhibitor p21Cip1, have little or no effect on progenitor proliferation. Hematopoietic stem cells have governing mechanisms that are distinct from the cells they generate.

### HEMATOPOIETIC STEM CELL DIFFERENTIATION

Hematopoietic stem cells sit at the base of a branching hierarchy of cells culminating in the many mature cell types that compose the blood and immune system (Fig. 1-2). The maturation steps leading to terminally differentiated and functional blood cells take place both as a consequence of intrinsic changes in gene expression and niche-directed and cytokine-directed changes in the cells. Our knowledge of the details remains incomplete (see <http://stemcell.princeton.edu/> for a comprehensive listing of gene expression in stem cells). As stem cells mature to progenitors, precursors, and, finally, mature effector cells, they undergo a series of functional changes. These include the obvious acquisition of functions defining mature blood cells, such as phagocytic capacity or hemoglobinization. They also include the progressive loss of plasticity, i.e., the ability to become other cell types. For example, the myeloid progenitor can make all cells in the myeloid series but none in the lymphoid series. As common myeloid progenitors mature, they become precursors for either monocytes and granulocytes or erythrocytes and megakaryocytes, but not both. Some amount of reversibility of this process may exist early in the differentiation cascade, but that is lost beyond a distinct stage. As cells differentiate, they may also lose proliferative capacity (Fig. 1-3). Mature granulocytes are incapable of proliferation and only increase in number by increased production from precursors. Lymphoid cells retain the capacity to proliferate but have linked their proliferation to the recognition of particular proteins or peptides by specific antigen receptors on their surface. In most tissues the



**FIGURE 1-2**

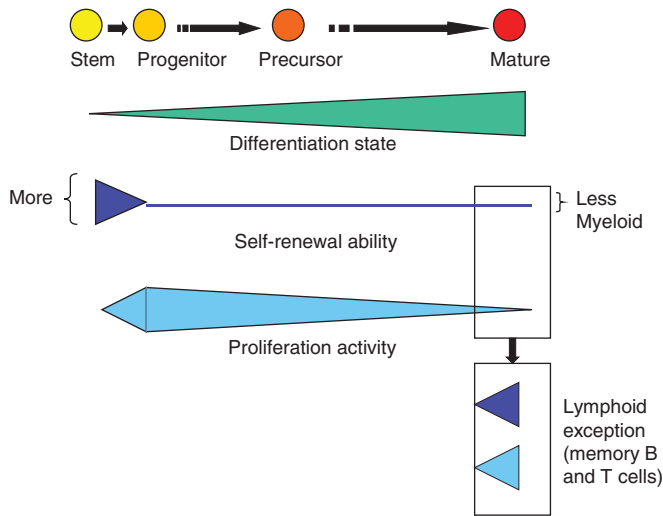
**Hierarchy of hematopoietic differentiation.** *Stem cells* are multipotent cells that are the source of all descendant cells and have the capacity to provide either long-term (measured in years) or short-term (measured in months) cell production. *Progenitor cells* have a more limited spectrum of cells they can produce and are generally a short-lived, highly proliferative population also known as transient amplifying cells. *Precursor cells* are cells committed to a single blood cell lineage but with a continued ability to proliferate; they do not have all the features of a fully mature cell. *Mature cells* are the

terminally differentiated product of the differentiation process and are the effector cells of specific activities of the blood and immune system. Progress through the pathways is mediated by alterations in gene expression. The regulation of the differentiation by soluble factors and cell-cell communications within the bone marrow niche are still being defined. The transcription factors that characterize particular cell transitions are illustrated on the arrows; the soluble factors that contribute to the differentiation process are in blue. EPO, erythropoietin; SCF, stem cell factor; TPO, thrombopoietin.

proliferative cell population is a more immature progenitor population. In general, cells within the highly proliferative progenitor cell compartment are also relatively short lived, making their way through the differentiation process in a defined molecular program involving the sequential activation of particular sets of genes. For any particular cell type, the differentiation program is difficult to speed up. The time it takes for hematopoietic progenitors to become mature cells is ~10–14 days in humans, evident clinically by the interval between cytotoxic chemotherapy and blood count recovery in patients.

## SELF-RENEWAL

The hematopoietic stem cell must balance its three potential fates: apoptosis, self-renewal, and differentiation. The proliferation of cells is generally not associated with the ability to undergo a self-renewing division except among memory T and B cells and among stem cells. Self-renewal capacity gives way to differentiation as the only option after cell division when cells leave the stem cell compartment, until they have the opportunity to become memory lymphocytes. In addition to

**FIGURE 1-3**

**Relative function of cells in the hematopoietic hierarchy.** The boxes represent distinct functional features of cells in the myeloid (*upper box*) versus lymphoid (*lower box*) lineages.

this self-renewing capacity, stem cells have an additional feature characterizing their proliferation machinery. Stem cells in most mature adult tissues are deeply quiescent. In the hematopoietic system, stem cells are also highly cytokine resistant, remaining dormant even when cytokines drive bone marrow progenitors to proliferation rates measured in hours, not days. Stem cells, in contrast, are thought to divide at intervals measured in months to years, at least as estimated in nonhuman primates. This deep quiescence is difficult to overcome *in vitro*, limiting the ability to expand human hematopoietic stem cells effectively. The process may be controlled by particularly high levels of expression of cyclin-dependent kinase inhibitors that restrict entry of stem cells into cell cycle, blocking the G1-S transition. Modifying the levels of molecules such as p21Cip1 and p18INK4c in the laboratory has resulted in increased stem cell proliferation and number in mice and in some limited human cell studies. Exogenous signals from the niche also appear to enforce quiescence, including the activation of the tyrosine kinase receptor Tie2 on stem cells by angiopoietin 1 on osteoblasts.

The regulation of stem cell proliferation also appears to change with age. In mice, the cyclin-dependent kinase inhibitor p16INK4a accumulates in stem cells in older animals and is associated with a change in five different stem cell functions, including cell cycling. Lowering expression of p16INK4a in older animals improves stem cell cycling and capacity to reconstitute hematopoiesis in adoptive hosts, making them similar to younger animals. Mature cell numbers are unaffected. Therefore, molecular events governing the specific functions of stem cells are being gradually made clear and offer the potential of new approaches to changing stem

cell function for therapy. One critical stem cell function that remains poorly defined is the molecular regulation of self-renewal.

For medicine, self-renewal is perhaps the most important function of stem cells because it is critical in regulating the number of stem cells. Stem cell number is a key limiting parameter for both autologous and allogeneic stem cell transplantation. Were we to have the ability to use fewer stem cells or expand limited numbers of stem cells *ex vivo*, it might be possible to reduce the morbidity and expense of stem cell harvests and enable use of other stem cell sources. Specifically, umbilical cord blood is a rich source of stem cells. However, the volume of cord blood units is extremely small, and therefore the total number of hematopoietic stem cells that can be obtained is generally only sufficient to transplant an individual of <40 kg. This limitation restricts what would otherwise be an extremely promising source of stem cells. Two features of cord blood stem cells are particularly important: (1) They are derived from a diversity of individuals that far exceeds the adult donor pool and therefore can overcome most immunologic cross-matching obstacles; and (2) Cord blood stem cells have a large number of T cells associated with them, but (paradoxically) they appear to be associated with a lower incidence of graft-versus-host disease when compared with similarly mismatched stem cells from other sources.

If stem cell expansion by self-renewal could be achieved, the number of cells available might be sufficient for use in larger adults. An alternative approach to this problem is to improve the efficiency of engraftment of donor stem cells. Graft engineering is exploring methods of adding cell components that may enhance engraftment. Furthermore, at least some data suggest that depletion of host NK (natural killer) cells may lower the number of stem cells necessary to reconstitute hematopoiesis.

Some limited understanding of self-renewal exists and, intriguingly, implicates gene products that are associated with the chromatin state, a high-order organization of chromosomal DNA that influences transcription. These include members of the polycomb family, a group of zinc finger-containing transcriptional regulators that interact with the chromatin structure, contributing to the accessibility of groups of genes for transcription. Certain members, including Bmi-1 and Gfi-1, are important in enabling hematopoietic stem cell self-renewal through modification of cell cycle regulators such as the cyclin-dependent kinase inhibitors. In the absence of either of these genes, hematopoietic stem cells decline in number and function. In contrast, dysregulation of *Bmi-1* has been associated with leukemia; it may promote leukemic stem cell self-renewal when it is overexpressed. Other transcription regulators have also been associated with self-renewal, particularly homeobox, or “hox,” genes. These transcription factors are named for their ability to govern large numbers of genes, including those determining body patterning in

invertebrates. HoxB4 is capable of inducing extensive self-renewal of stem cells through its DNA-binding motif. Other members of the hox family of genes have been noted to affect normal stem cells, but they are also associated with leukemia. External signals that may influence the relative self-renewal versus differentiation outcomes of stem cell cycling include the Notch ligands and specific Wnt ligands. Intracellular signal transducing intermediates are also implicated in regulating self-renewal but, interestingly, are not usually associated with the pathways activated by Notch or Wnt receptors. They include PTEN, an inhibitor of the AKT pathway, and STAT5, both of which are usually downstream of activated growth factor receptors and necessary for normal stem cell functions, including self-renewal, at least in mouse models. The connections between these molecules remain to be defined, and their role in physiologic regulation of stem cell self-renewal is still poorly understood.

### CANCER IS SIMILAR TO AN ORGAN WITH SELF-RENEWING CAPACITY

The relationship of stem cells to cancer is an important evolving dimension of adult stem cell biology. Cancer may share principles of organization with normal tissues. Cancer might have the same hierarchical organization of cells with a base of stemlike cells capable of the signature stem cell features: self-renewal and differentiation. These stemlike cells might be the basis for perpetuation of the tumor and represent a slowly dividing rare population with distinct regulatory mechanisms, including a relationship with a specialized microenvironment. A subpopulation of self-renewing cells in cancer has been defined. A more sophisticated understanding of the stem cell organization of cancers may lead to improved strategies for attacking the many common and difficult-to-treat types of malignancies that have been relatively refractory to interventions aimed at dividing cells.

Does the concept of cancer stem cells provide insight into the cellular origin of cancer? The fact that some cells within a cancer have stem cell-like properties does not necessarily mean that the cancer arose in the stem cell itself. Rather, more mature cells could have acquired the self-renewal characteristics of stem cells. Any single genetic event is unlikely to be sufficient to enable full transformation of a normal cell to a frankly malignant one. Rather, cancer is a multistep process, and for the multiple steps to accumulate, the cell of origin must be able to persist for prolonged periods. It must also be able to generate large numbers of daughter cells. The normal stem cell has these properties and, by virtue of its having intrinsic self-renewal capability, may be more readily converted to a malignant phenotype. This hypothesis has been tested experimentally in the hematopoietic system. Taking advantage of the cell-surface markers that distinguish

hematopoietic cells of varying maturity, stem cells, progenitors, precursors, and mature cells can be isolated. Powerful transforming gene constructs were placed in these cells, and it was found that the cell with the greatest potential to produce a malignancy was indeed the stem cell. This does not prove that stem cells give rise to all tumors, but it does suggest that stem cells may be susceptible to malignant conversion and may be the population of greatest interest in developing strategies to protect against, monitor, or treat nascent malignancy.

### WHAT ELSE CAN HEMATOPOIETIC STEM CELLS DO?

Some experimental data have suggested that hematopoietic stem cells or other cells mobilized into the circulation by the same factors that mobilize hematopoietic stem cells are capable of playing a role in healing the vascular and tissue damage associated with stroke and myocardial infarction. These data are controversial, and the applicability of a stem cell approach to nonhematopoietic conditions remains experimental. However, the application of the evolving knowledge of hematopoietic stem cell biology may lead to wide-ranging clinical uses.

The stem cell therefore represents a true dual-edged sword. It has tremendous healing capacity and is essential for life. Uncontrolled, it can threaten the life it maintains. Understanding how stem cells function, the signals that modify their behavior, and the tissue niches that modulate stem cell responses to injury and disease are critical for more effectively developing stem cell-based medicine. That aspect of medicine will include the use of the stem cells and the use of drugs to target stem cells to enhance repair of damaged tissues. It will also include the careful balance of interventions to control stem cells where they may be dysfunctional or malignant.

### FURTHER READINGS

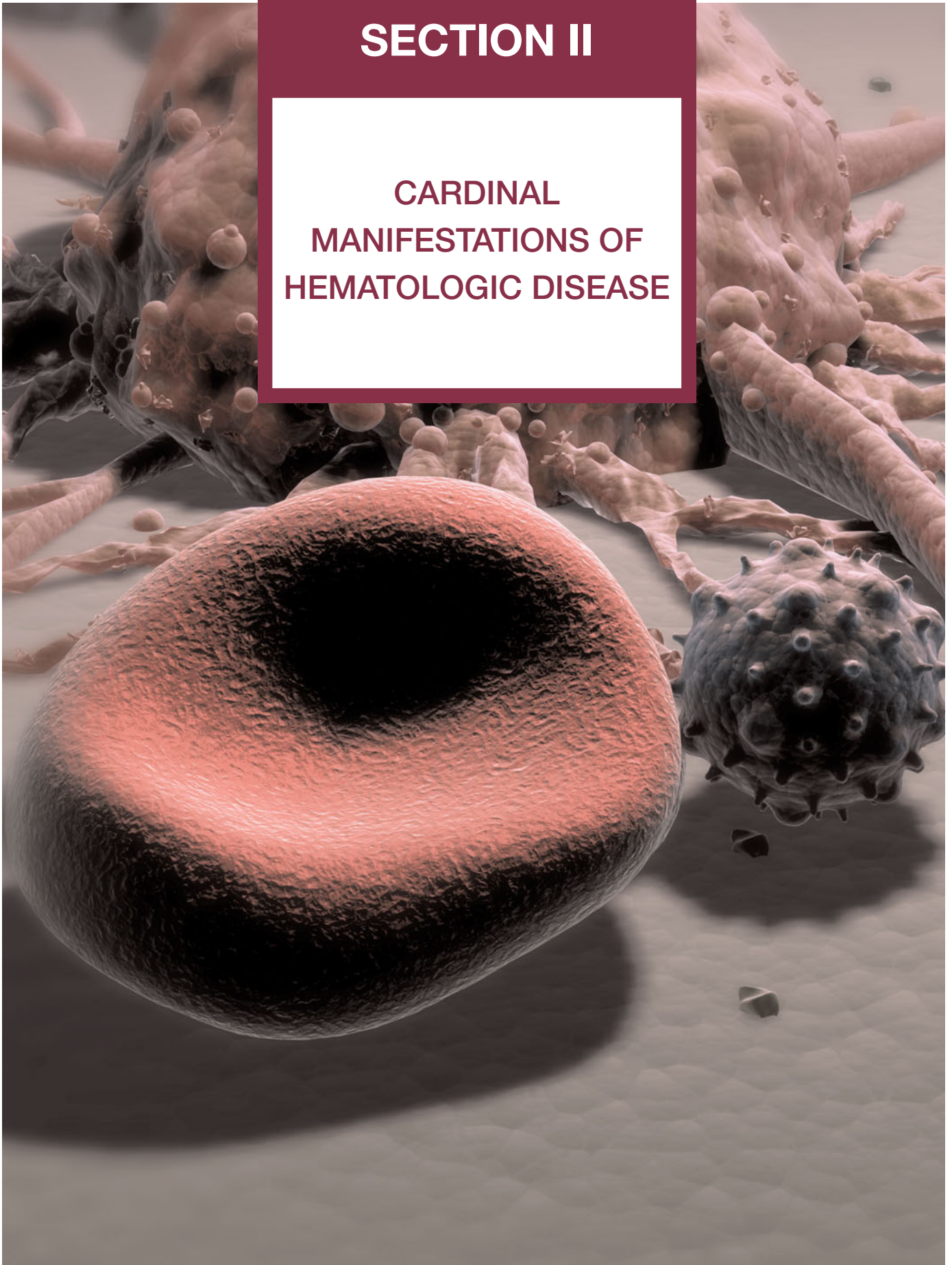
- CHUTE JP: Stem cell homing. *Curr Opin Hematol* 13:399, 2006
- FUCHS E: The tortoise and the hare: slow-cycling cells in the stem cell race. *Cell* 137:811, 2009
- JORDAN CT: The leukemic stem cell. *Best Pract Res Clin Haematol* 20:13, 2007
- KUCI S et al: Adult stem cells as an alternative source of multipotential (pluripotential) cells in regenerative medicine. *Curr Stem Cell Res Ther* 4:107, 2009
- LAIOSA CV et al: Determinants of lymphoid-myeloid lineage diversification. *Annu Rev Immunol* 24:705, 2006
- MIKKOLA HK, ORKIN SH: The journey of developing hematopoietic stem cells. *Development* 133:3733, 2006
- SCADDEN DT: The stem cell niche as an entity of action. *Nature* 441:1075, 2006
- WAGSTAFF AJ: Plerixafor: in patients with non-Hodgkin's lymphoma or multiple myeloma. *Drugs* 69:319, 2009
- YUSUF RZ, SCADDEN DT: Homing of hematopoietic cells to the bone marrow. *J Vis Exp Mar* 18;(25)pii:1104, 2009

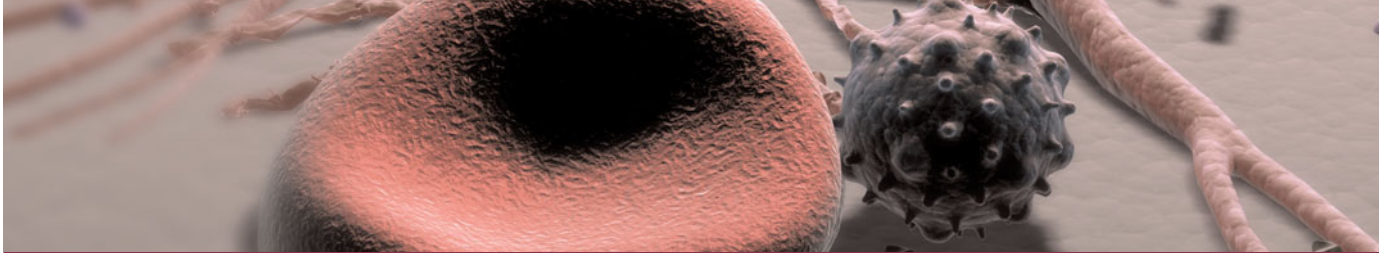


*This page intentionally left blank*

# SECTION II

## CARDINAL MANIFESTATIONS OF HEMATOLOGIC DISEASE





## CHAPTER 2

# ANEMIA AND POLYCYTHEMIA

John W. Adamson ■ Dan L. Longo

■ Hematopoiesis and the Physiologic Basis of Red Cell Production . . . . .	.10
■ Anemia . . . . .	.11
Clinical Presentation of Anemia . . . . .	.11
Definition and Classification of Anemia . . . . .	.18
■ Polycythemia . . . . .	.20
■ Further Readings . . . . .	.21

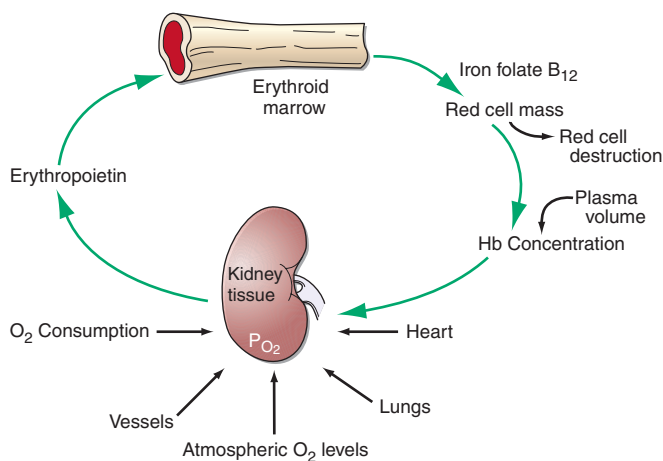
### HEMATOPOIESIS AND THE PHYSIOLOGIC BASIS OF RED CELL PRODUCTION

*Hematopoiesis* is the process by which the formed elements of the blood are produced. The process is regulated through a series of steps beginning with the pluripotent hematopoietic stem cell. Stem cells are capable of producing red cells, all classes of granulocytes, monocytes, platelets, and the cells of the immune system. The precise molecular mechanism—either intrinsic to the stem cell itself or through the action of extrinsic factors—by which the stem cell becomes committed to a given lineage is not fully defined. However, experiments in mice suggest that erythroid cells come from a common erythroid/megakaryocyte progenitor that does not develop in the absence of expression of the GATA-1 and FOG-1 (friend of GATA-1) transcription factors (Chap. 1). Following lineage commitment, hematopoietic progenitor and precursor cells come increasingly under the regulatory influence of growth factors and hormones. For red cell production, erythropoietin (EPO) is the regulatory hormone. EPO is required for the maintenance of committed erythroid progenitor cells that, in the absence of the hormone, undergo programmed cell death (*apoptosis*). The regulated process of red cell production is erythropoiesis, and its key elements are illustrated in [Fig. 2-1](#).

In the bone marrow, the first morphologically recognizable erythroid precursor is the pronormoblast. This cell can undergo 4–5 cell divisions that result in the production of 16–32 mature red cells. With increased EPO production, or the administration of EPO as a drug, early progenitor cell numbers are amplified and, in turn, give rise to increased numbers of erythrocytes. The regulation of EPO production itself is linked to O<sub>2</sub> availability.

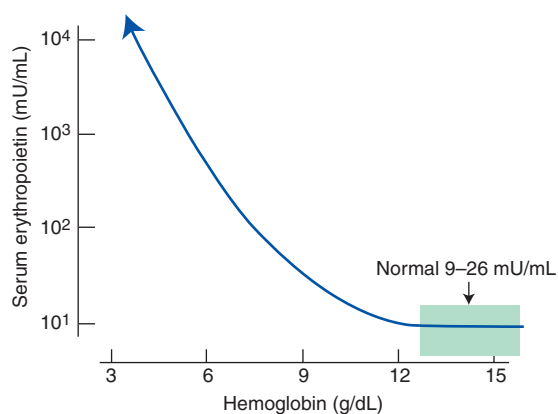
In mammals, O<sub>2</sub> is transported to tissues bound to the hemoglobin contained within circulating red cells. The mature red cell is 8 μm in diameter, anucleate, discoid in shape, and extremely pliable in order to traverse the microcirculation successfully; its membrane integrity is maintained by the intracellular generation of ATP. Normal red cell production results in the daily replacement of 0.8–1% of all circulating red cells in the body because the average red cell lives 100–120 days. The organ responsible for red cell production is called the *erythron*. The erythron is a dynamic organ made up of a rapidly proliferating pool of marrow erythroid precursor cells and a large mass of mature circulating red blood cells. The size of the red cell mass reflects the balance of red cell production and destruction. The physiologic basis of red cell production and destruction provides an understanding of the mechanisms that can lead to anemia.

The physiologic regulator of red cell production, the glycoprotein hormone EPO, is produced and released by peritubular capillary lining cells within the kidney. These cells are highly specialized epithelial-like cells. A small



**FIGURE 2-1**  
The physiologic regulation of red cell production by tissue oxygen tension. Hb, hemoglobin.

amount of EPO is produced by hepatocytes. The fundamental stimulus for EPO production is the availability of  $O_2$  for tissue metabolic needs. Impaired  $O_2$  delivery to the kidney can result from a decreased red cell mass (*anemia*); impaired  $O_2$  loading of the hemoglobin molecule or a high  $O_2$  affinity mutant hemoglobin (*hypoxemia*); or, rarely, impaired blood flow to the kidney (renal artery stenosis). EPO governs the day-to-day production of red cells, and ambient levels of the hormone can be measured in the plasma by sensitive immunoassays (normal level: 10–25 U/L). When the hemoglobin concentration falls below 100–120 g/L (10–12 g/dL), plasma EPO levels increase in proportion to the severity of the anemia (Fig. 2-2). In circulation, EPO has a



**FIGURE 2-2**  
Erythropoietin levels in response to anemia. When the hemoglobin level falls to 120 g/L (12 g/dL), plasma erythropoietin levels increase logarithmically. In the presence of renal disease or chronic inflammation, EPO levels are typically lower than expected for a particular level of anemia. As individuals age, the level of EPO needed to sustain normal hemoglobin levels appears to increase. (From Hillman et al.)

half-clearance time of 6–9 hours. EPO acts by binding to specific receptors on the surface of marrow erythroid precursors, inducing them to proliferate and to mature. With EPO stimulation, red cell production can increase four- to fivefold within a 1- to 2-week period but only in the presence of adequate nutrients, especially iron. The functional capacity of the erythron, therefore, requires normal renal production of EPO, a functioning erythroid marrow, and an adequate supply of substrates for hemoglobin synthesis. A defect in any of these key components can lead to anemia. Generally, anemia is recognized in the laboratory when a patient's hemoglobin level or hematocrit is reduced below an expected value (the normal range). The likelihood and severity of anemia are defined based on the deviation of the patient's hemoglobin/hematocrit from values expected for age- and sex-matched normal subjects. The hemoglobin concentration in adults has a Gaussian distribution. The mean hematocrit value for adult males is 47% ( $\pm$ SD 7) and that for adult females is 42% ( $\pm$ 5). Any single hematocrit or hemoglobin value carries with it a likelihood of associated anemia. Thus a hematocrit of  $\leq$ 39% in an adult male or  $<$ 35% in an adult female has only about a 25% chance of being normal. Suspected low hemoglobin or hematocrit values are more easily interpreted if previous values for the same patient are known for comparison. The World Health Organization (WHO) defines anemia as a hemoglobin level  $<$ 130 g/L (13 g/dL) in men and  $<$ 120 g/L (12 g/dL) in women.

The critical elements of erythropoiesis—EPO production, iron availability, the proliferative capacity of the bone marrow, and effective maturation of red cell precursors—are used for the initial classification of anemia (see next section).

## ANEMIA

### CLINICAL PRESENTATION OF ANEMIA

#### Signs and Symptoms

Anemia is most often recognized by abnormal screening laboratory tests. Patients less commonly present with advanced anemia and its attendant signs and symptoms. Acute anemia is nearly always due to blood loss or hemolysis. If blood loss is mild, enhanced  $O_2$  delivery is achieved through changes in the  $O_2$ -hemoglobin dissociation curve mediated by a decreased pH or increased  $CO_2$  (*Bohr effect*). With acute blood loss, hypovolemia dominates the clinical picture and the hematocrit and hemoglobin levels do not reflect the volume of blood lost. Signs of vascular instability appear with acute losses of 10–15% of the total blood volume. In such patients, the issue is not anemia but hypotension and decreased organ perfusion. When  $>$ 30% of the blood volume is lost suddenly, patients are unable to compensate with

12 the usual mechanisms of vascular contraction and changes in regional blood flow. The patient prefers to remain supine and will show postural hypotension and tachycardia. If the volume of blood lost is >40% (i.e., >2 L in the average-sized adult), signs of hypovolemic shock including confusion, dyspnea, diaphoresis, hypotension, and tachycardia appear (Chap. 10). Such patients have significant deficits in vital organ perfusion and require immediate volume replacement.

With acute hemolytic disease, the signs and symptoms depend on the mechanism that leads to red cell destruction. Intravascular hemolysis with release of free hemoglobin may be associated with acute back pain, free hemoglobin in the plasma and urine, and renal failure. Symptoms associated with more chronic or progressive anemia depend on the age of the patient and the adequacy of blood supply to critical organs. Symptoms associated with moderate anemia include fatigue, loss of stamina, breathlessness, and tachycardia (particularly with physical exertion). However, because of the intrinsic compensatory mechanisms that govern the O<sub>2</sub>-hemoglobin dissociation curve, the gradual onset of anemia—particularly in young patients—may not be associated with signs or symptoms until the anemia is severe [hemoglobin <70–80 g/L (7–8 g/dL)]. When anemia develops over a period of days or weeks, the total blood volume is normal to slightly increased and changes in cardiac output and regional blood flow help compensate for the overall loss in O<sub>2</sub>-carrying capacity. Changes in the position of the O<sub>2</sub>-hemoglobin dissociation curve account for some of the compensatory response to anemia. With chronic anemia, intracellular levels of 2,3-bisphosphoglycerate rise, shifting the dissociation curve to the right and facilitating O<sub>2</sub> unloading. This compensatory mechanism can only maintain normal tissue O<sub>2</sub> delivery in the face of a 20–30 g/L (2–3 g/dL) deficit in hemoglobin concentration. Finally, further protection of O<sub>2</sub> delivery to vital organs is achieved by the shunting of blood away from organs that are relatively rich in blood supply, particularly the kidney, gut, and skin.

Certain disorders are commonly associated with anemia. Chronic inflammatory states (e.g., infection, rheumatoid arthritis) are associated with mild to moderate anemia, whereas lymphoproliferative disorders, such as chronic lymphocytic leukemia and certain other B cell neoplasms, may be associated with autoimmune hemolysis.

### Approach to the Patient: ANEMIA

The evaluation of the patient with anemia requires a careful history and physical examination. Nutritional history related to drugs or alcohol intake and family history of anemia should always be assessed. Certain geographic backgrounds and ethnic origins are associated

with an increased likelihood of an inherited disorder of the hemoglobin molecule or intermediary metabolism. Glucose-6-phosphate dehydrogenase (G6PD) deficiency and certain hemoglobinopathies are seen more commonly in those of Middle Eastern or African origin, including African Americans who have a high frequency of G6PD deficiency. Other information that may be useful includes exposure to certain toxic agents or drugs and symptoms related to other disorders commonly associated with anemia. These include symptoms and signs such as bleeding, fatigue, malaise, fever, weight loss, night sweats, and other systemic symptoms. Clues to the mechanisms of anemia may be provided on physical examination by findings of infection, blood in the stool, lymphadenopathy, splenomegaly, or petechiae. Splenomegaly and lymphadenopathy suggest an underlying lymphoproliferative disease; petechiae suggest platelet dysfunction. Past laboratory measurements may be helpful to determine a time of onset.

In the patient with anemia, physical examination may demonstrate a forceful heartbeat, strong peripheral pulses, and a systolic “flow” murmur. The skin and mucous membranes may be pale if the hemoglobin is <80–100 g/L (8–10 g/dL). This part of the physical examination should focus on areas where vessels are close to the surface such as the mucous membranes, nail beds, and palmar creases. If the palmar creases are lighter in color than the surrounding skin when the hand is hyperextended, the hemoglobin level is usually <80 g/L (8 g/dL).

**LABORATORY EVALUATION** Table 2-1 lists the tests used in the initial workup of anemia. A routine complete blood count (CBC) is required as part of the evaluation and includes the hemoglobin, hematocrit, and red cell indices: the mean cell volume (MCV) in femtoliters, mean cell hemoglobin (MCH) in picograms per cell, and mean concentration of hemoglobin per volume of red cells (MCHC) in grams per liter (non-SI: grams per deciliter). The red cell indices are calculated as shown in Table 2-2, and the normal variations in the hemoglobin and hematocrit with age are shown in Table 2-3. A number of physiologic factors affect the CBC, including age, sex, pregnancy, smoking, and altitude. High-normal hemoglobin values may be seen in men and women who live at altitude or smoke heavily. Hemoglobin elevations due to smoking reflect normal compensation due to the displacement of O<sub>2</sub> by CO in hemoglobin binding. Other important information is provided by the reticulocyte count and measurements of iron supply including *serum iron*, *total iron-binding capacity* (TIBC; an indirect measure of the transferrin level), and *serum ferritin*. Marked alterations in the red cell indices usually reflect disorders of maturation or iron deficiency. A careful evaluation of the peripheral blood smear is

TABLE 2-1

LABORATORY TESTS IN ANEMIA	
I. Complete blood count (CBC)	II. Iron supply studies
A. Red blood cell count	A. Serum iron
1. Hemoglobin	B. Total iron-binding capacity
2. Hematocrit	C. Serum ferritin
3. Reticulocyte count	III. Marrow examination
B. Red blood cell indices	A. Aspirate
1. Mean cell volume (MCV)	1. M/E ratio <sup>a</sup>
2. Mean cell hemoglobin (MCH)	2. Cell morphology
3. Mean cell hemoglobin concentration (MCHC)	3. Iron stain
4. Red cell distribution width (RDW)	B. Biopsy
C. White blood cell count	1. Cellularity
1. Cell differential	2. Morphology
2. Nuclear segmentation of neutrophils	
D. Platelet count	
E. Cell morphology	
1. Cell size	
2. Hemoglobin content	
3. Anisocytosis	
4. Poikilocytosis	
5. Polychromasia	

<sup>a</sup>M/E ratio, ratio of myeloid to erythroid precursors.

important, and clinical laboratories often provide a description of both the red and white cells, a white cell differential count, and the platelet count. In patients with severe anemia and abnormalities in red blood cell morphology and/or low reticulocyte counts, a bone marrow aspirate or biopsy may be important to assist in the diagnosis. Other tests of value in the diagnosis of specific anemias are discussed in chapters on specific disease states.

The components of the CBC also help in the classification of anemia. *Microcytosis* is reflected by a lower

TABLE 2-2

RED BLOOD CELL INDICES	
INDEX	NORMAL VALUE
Mean cell volume (MCV) = (hematocrit $\pm$ 10)/ (red cell count $\times$ 10 <sup>6</sup> )	90 $\pm$ 8 fL
Mean cell hemoglobin (MCH) = (hemoglobin $\times$ 10)/ (red cell count $\times$ 10 <sup>6</sup> )	30 $\pm$ 3 pg
Mean cell hemoglobin concentration = (hemoglobin $\times$ 10)/ hematocrit, or MCH/MCV	33 $\pm$ 2%

TABLE 2-3

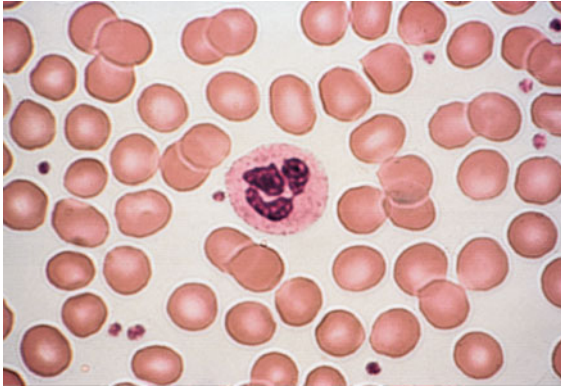
CHANGES IN NORMAL HEMOGLOBIN/HEMATOCRIT VALUES WITH AGE AND PREGNANCY		
AGE/SEX	HEMOGLOBIN g/dL	HEMATOCRIT %
At birth	17	52
Childhood	12	36
Adolescence	13	40
Adult man	16 ( $\pm$ 2)	47 ( $\pm$ 6)
Adult woman (menstruating)	13 ( $\pm$ 2)	40 ( $\pm$ 6)
Adult woman (postmenopausal)	14 ( $\pm$ 2)	42 ( $\pm$ 6)
During pregnancy	12 ( $\pm$ 2)	37 ( $\pm$ 6)

Source: From Hillman et al.

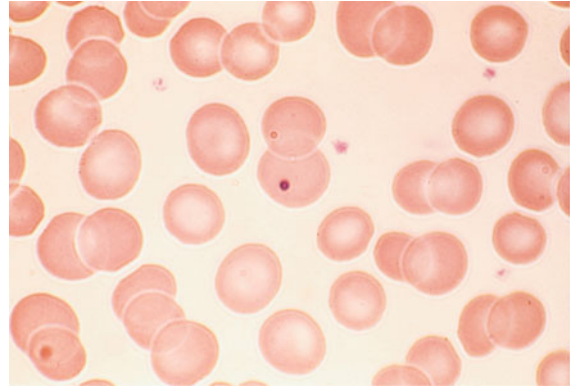
than normal MCV (<80), whereas high values (>100) reflect *macrocytosis*. The MCH and MCHC reflect defects in hemoglobin synthesis (*hypochromia*). Automated cell counters describe the red cell volume distribution width (RDW). The MCV (representing the peak of the distribution curve) is insensitive to the appearance of small populations of macrocytes or microcytes. An experienced laboratory technician will be able to identify minor populations of large or small cells or hypochromic cells before the red cell indices change.

**Peripheral Blood Smear** The peripheral blood smear provides important information about defects in red cell production. As a complement to the red cell indices, the blood smear also reveals variations in cell size (*anisocytosis*) and shape (*poikilocytosis*). The degree of anisocytosis usually correlates with increases in the RDW or the range of cell sizes. Poikilocytosis suggests a defect in the maturation of red cell precursors in the bone marrow or fragmentation of circulating red cells. The blood smear may also reveal *polychromasia*—red cells that are slightly larger than normal and grayish blue in color on the Wright-Giemsa stain. These cells are reticulocytes that have been prematurely released from the bone marrow, and their color represents residual amounts of ribosomal RNA. These cells appear in circulation in response to EPO stimulation or to architectural damage of the bone marrow (fibrosis, infiltration of the marrow by malignant cells, etc.) that results in their disordered release from the marrow. The appearance of nucleated red cells, Howell-Jolly bodies, target cells, sickle cells, and others may provide clues to specific disorders (Figs. 2-3 to 2-11).

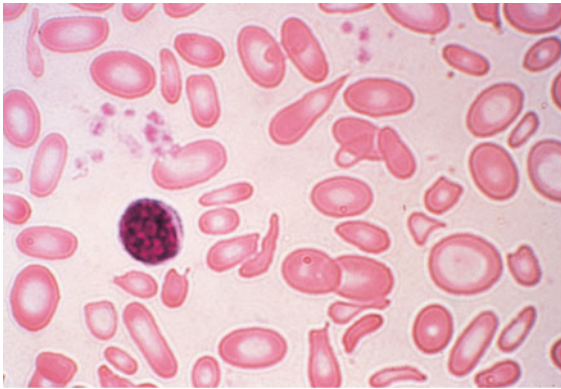
**Reticulocyte Count** An accurate reticulocyte count is key to the initial classification of anemia. Normally, reticulocytes are red cells that have been recently



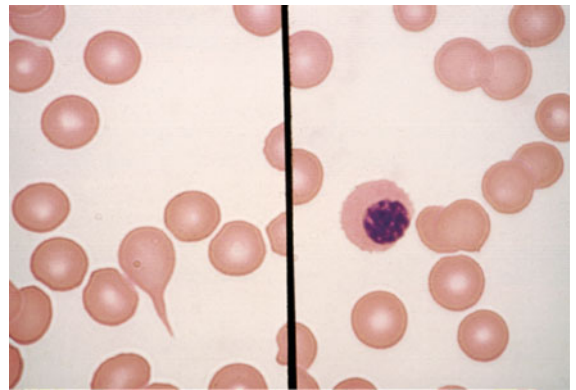
**FIGURE 2-3**  
**Normal blood smear (Wright stain).** High-power field showing normal red cells, a neutrophil, and a few platelets. (From Hillman et al.)



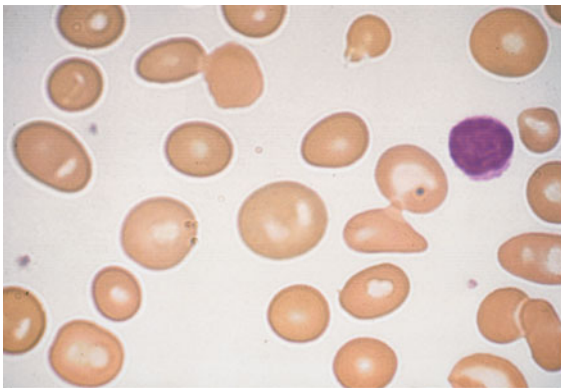
**FIGURE 2-6**  
**Howell-Jolly bodies.** In the absence of a functional spleen, nuclear remnants are not culled from the red cells and remain as small homogeneously staining blue inclusions on Wright stain. (From Hillman et al.)



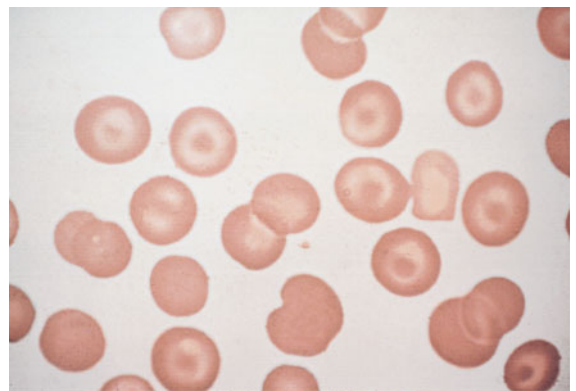
**FIGURE 2-4**  
**Severe iron-deficiency anemia.** Microcytic and hypochromic red cells smaller than the nucleus of a lymphocyte associated with marked variation in size (anisocytosis) and shape (poikilocytosis). (From Hillman et al.)



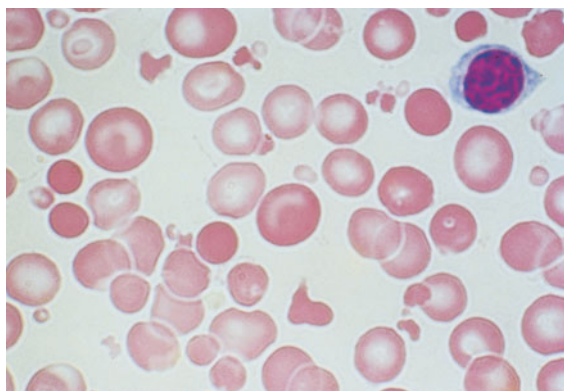
**FIGURE 2-7**  
**Red cell changes in myelofibrosis.** The left panel shows a teardrop-shaped cell. The right panel shows a nucleated red cell. These forms are seen in myelofibrosis with extramedullary hematopoiesis.



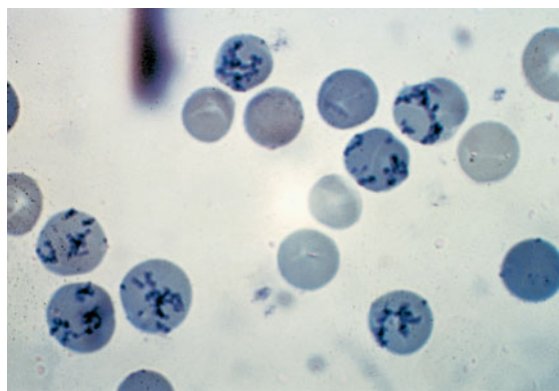
**FIGURE 2-5**  
**Macrocytosis.** Red cells are larger than a small lymphocyte and well hemoglobinized. Often macrocytes are oval-shaped (macroovalocytes).



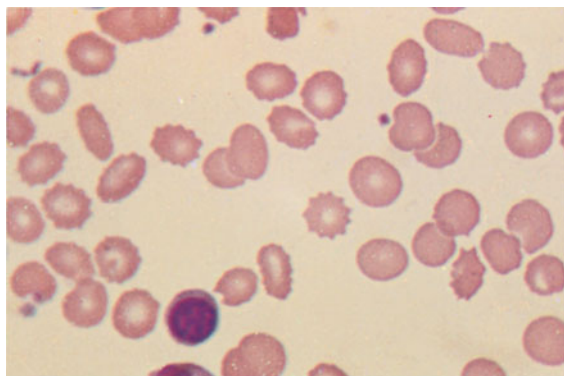
**FIGURE 2-8**  
**Target cells.** Target cells have a bull's-eye appearance and are seen in thalassemia and in liver disease. (From Hillman et al.)

**FIGURE 2-9**

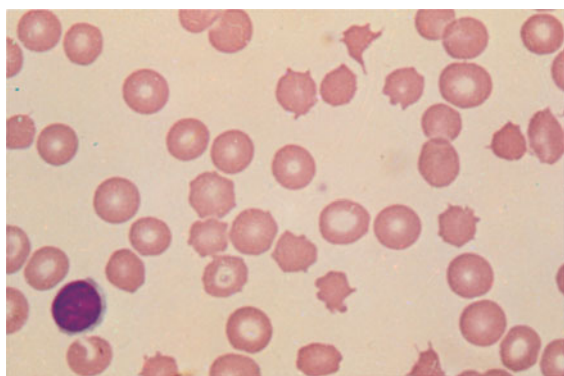
**Red cell fragmentation.** Red cells may become fragmented in the presence of foreign bodies in the circulation such as mechanical heart valves or in the setting of thermal injury. (From Hillman et al.)

**FIGURE 2-12**

**Reticulocytes.** Methylene blue stain demonstrates residual RNA in newly made red cells. (From Hillman et al.)

**FIGURE 2-10**

**Uremia.** The red cells in uremia may acquire numerous, regularly spaced, small spiny projections. Such cells, called burr cells or echinocytes, are readily distinguishable from irregularly spiculated acanthocytes shown in Fig. 2-11.

**FIGURE 2-11**

**Spur cells.** Spur cells are recognized as distorted red cells containing several irregularly distributed thornlike projections. Cells with this morphologic abnormality are also called acanthocytes. (From Hillman et al.)

released from the bone marrow. They are identified by staining with a supravital dye that precipitates the ribosomal RNA (Fig. 2-12). These precipitates appear as blue or black punctate spots. This residual RNA is metabolized over the first 24–36 h of the reticulocyte's life span in circulation. Normally, the reticulocyte count ranges from 1–2% and reflects the daily replacement of 0.8–1.0% of the circulating red cell population. A reticulocyte count provides a reliable measure of red cell production.

In the initial classification of anemia, the patient's reticulocyte count is compared with the expected reticulocyte response. In general, if the EPO and erythroid marrow responses to moderate anemia [hemoglobin <100 g/L (10 g/dL)] are intact, the red cell production rate increases to two to three times normal within 10 days following the onset of anemia. In the face of established anemia, a reticulocyte response less than two to three times normal indicates an inadequate marrow response.

To use the reticulocyte count to estimate marrow response, two corrections are necessary. The first correction adjusts the reticulocyte count based on the reduced number of circulating red cells. With anemia, the percentage of reticulocytes may be increased while the absolute number is unchanged. To correct for this effect, the reticulocyte percentage is multiplied by the ratio of the patient's hemoglobin or hematocrit to the expected hemoglobin/hematocrit for the age and gender of the patient (Table 2-4). This provides an estimate of the reticulocyte count corrected for anemia. To convert the corrected reticulocyte count to an index of marrow production, a further correction is required, depending on whether some of the reticulocytes in circulation have been released from the marrow prematurely. For this second correction, the peripheral blood smear is examined to see if there are polychromatophilic macrocytes present. These cells,



### CALCULATION OF RETICULOCYTE PRODUCTION INDEX

Correction #1 for anemia:

This correction produces the corrected reticulocyte count  
In a person whose reticulocyte count is 9%,  
hemoglobin 7.5 g/dL, hematocrit 23%, the absolute  
reticulocyte count =  $9 \times (7.5/15)$  [or  $\times (23/45)$ ] = 4.5%

Correction #2 for longer life of prematurely released  
reticulocytes in the blood:

This correction produces the reticulocyte  
production index

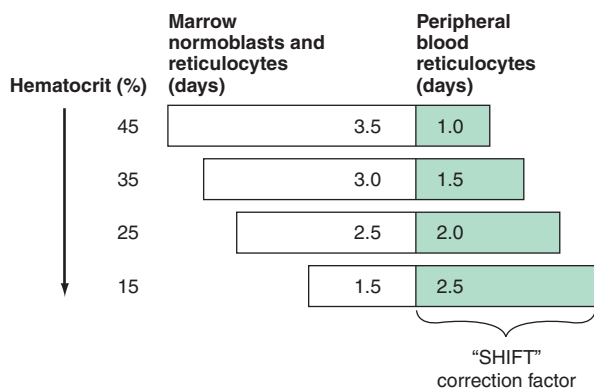
In a person whose reticulocyte count is 9%,  
hemoglobin 7.5 gm/dL, hematocrit 23%, the  
reticulocyte production index

$$= 9 \times \frac{(7.5/15)(\text{hemoglobin correction})}{2 \text{ (maturation time correction)}} = 2.25$$

representing prematurely released reticulocytes, are referred to as “shift” cells, and the relationship between the degree of shift and the necessary shift correction factor is shown in [Fig. 2-13](#). The correction is necessary because these prematurely released cells survive as reticulocytes in circulation for >1 day, thereby providing a falsely high estimate of daily red cell production. If polychromasia is increased, the reticulocyte count, already corrected for anemia,

should be divided again by a factor of 2 to account for the prolonged reticulocyte maturation time. The second correction factor varies from 1–3 depending on the severity of anemia. In general, a correction of 2 is commonly used. An appropriate correction is shown in Table 2-4. If polychromatophilic cells are not seen on the blood smear, the second correction is not required. The now doubly corrected reticulocyte count is the *reticulocyte production index*, and it provides an estimate of marrow production relative to normal.

Premature release of reticulocytes is normally due to increased EPO stimulation. However, if the integrity of the bone marrow release process is lost through tumor infiltration, fibrosis, or other disorders, the appearance of nucleated red cells or polychromatophilic macrocytes should still invoke the second reticulocyte correction. The shift correction should always be applied to a patient with anemia and a very high reticulocyte count to provide a true index of effective red cell production. Patients with severe chronic hemolytic anemia may increase red cell production as much as six- to sevenfold. This measure alone, therefore, confirms the fact that the patient has an appropriate EPO response, a normally functioning bone marrow, and sufficient iron available to meet the demands for new red cell formation. [Table 2-5](#) demonstrates the normal marrow response to anemia. If the reticulocyte production index is <2 in the face of established anemia, a defect in erythroid marrow proliferation or maturation must be present.



**FIGURE 2-13**

**Correction of the reticulocyte count.** In order to use the reticulocyte count as an indicator of effective red cell production, the reticulocyte number must be corrected based on the level of anemia and the circulating life span of the reticulocytes. Erythroid cells take ~4.5 days to mature. At normal hematocrit levels, they are released to the circulation with ~1 day left as reticulocytes. However, with different levels of anemia, erythroid cells are released from the marrow prematurely. Most patients come to clinical attention with hematocrits in the mid-20s and thus a correction factor of 2 is commonly used because the observed reticulocytes will live for 2 days in the circulation before losing their RNA.

**Tests of Iron Supply and Storage** The laboratory measurements that reflect the availability of iron for hemoglobin synthesis include the serum iron, the TIBC, and the percent transferrin saturation. The percent transferrin saturation is derived by dividing the serum iron level ( $\times 100$ ) by the TIBC. The normal serum iron ranges from 9–27  $\mu\text{mol/L}$  (50–150  $\mu\text{g/dL}$ ), and the normal TIBC is 54–64  $\mu\text{mol/L}$  (300–360  $\mu\text{g/dL}$ ); the normal transferrin saturation ranges from 25–50%. A diurnal variation in the serum iron leads to a variation in the percent transferrin saturation. The serum ferritin is used to evaluate total-body iron stores. Adult males have serum ferritin levels that average ~100  $\mu\text{g/L}$ , corresponding to iron stores of 1 g. Adult females have lower serum ferritin levels averaging 30  $\mu\text{g/L}$ , reflecting lower iron stores (300 mg). A serum ferritin level of 10–15  $\mu\text{g/L}$  represents depletion of body iron stores. However, ferritin is also an acute-phase reactant and, in the presence of acute or chronic inflammation, may rise severalfold above baseline levels. As a rule, a serum ferritin >200  $\mu\text{g/L}$  means there is at least some iron in tissue stores.

TABLE 2-5

## NORMAL MARROW RESPONSE TO ANEMIA

HEMATOCRIT	PRODUCTION INDEX	RETICULOCYTES (INCL CORRECTIONS)	MARROW M:E RATIO
45	1	1	3:1
35	2.0–3.0	4.8%/3.8/2.5	2:1–1:1
25	3.0–5.0	14%/8/4.0	1:1–1:2
15	3.0–5.0	30%/10/4.0	1:1–1:2

**Bone Marrow Examination** A bone marrow aspirate and smear or a needle biopsy may be useful in the evaluation of some patients with anemia. In patients with hypoproliferative anemia and normal iron status, a bone marrow is indicated. Marrow examination can diagnose primary marrow disorders such as myelofibrosis, a red cell maturation defect, or an infiltrative disease (Figs. 2-14 to 2-16). The increase or decrease of one cell lineage (myeloid vs erythroid) compared to another is obtained by a differential count of nucleated cells in a bone marrow smear [the myeloid/erythroid (M/E) ratio]. A patient with a hypoproliferative anemia (see later) and a reticulocyte production index  $<2$  will demonstrate an M/E ratio of 2 or 3:1. In contrast, patients with hemolytic disease and a production index  $>3$  will have an M/E ratio of at least 1:1. Maturation disorders are identified from the discrepancy between the M/E ratio and the reticulocyte production index (see later). Either the marrow smear or biopsy can be stained for the presence of iron stores or iron in developing red cells. The storage iron is in the form of ferritin or *hemosiderin*. On carefully prepared bone marrow smears, small ferritin granules can normally be seen under oil

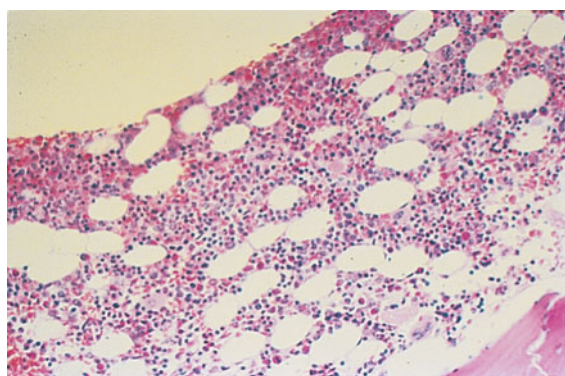


FIGURE 2-14

**Normal bone marrow.** This is a low-power view of a section of a normal bone marrow biopsy stained with hematoxylin and eosin (H&E). Note that the nucleated cellular elements account for ~40–50% and the fat (clear areas) accounts for ~50–60% of the area. (From Hillman et al.)

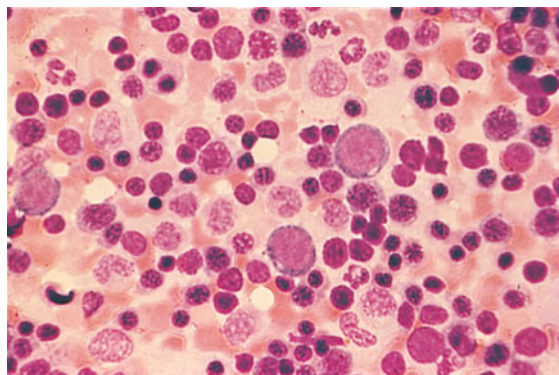


FIGURE 2-15

**Erythroid hyperplasia.** This marrow shows an increase in the fraction of cells in the erythroid lineage as might be seen when a normal marrow compensates for acute blood loss or hemolysis. The M/E ratio is about 1:1. (From Hillman et al.)

immersion in 20–40% of developing erythroblasts. Such cells are called *sideroblasts*.

**Other Laboratory Measurements** Additional laboratory tests may be of value in confirming specific diagnoses. For details of these tests and how they are applied in individual disorders, see Chaps. 7 to 11.

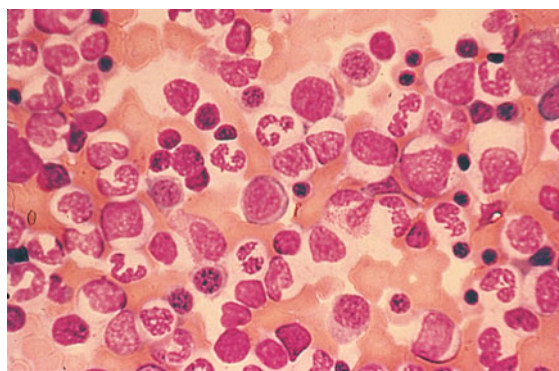


FIGURE 2-16

**Myeloid hyperplasia.** This marrow shows an increase in the fraction of cells in the myeloid or granulocytic lineage as might be seen in a normal marrow responding to infection. The M/E ratio is  $>3:1$ . (From Hillman et al.)

## 18 DEFINITION AND CLASSIFICATION OF ANEMIA

### Initial Classification of Anemia

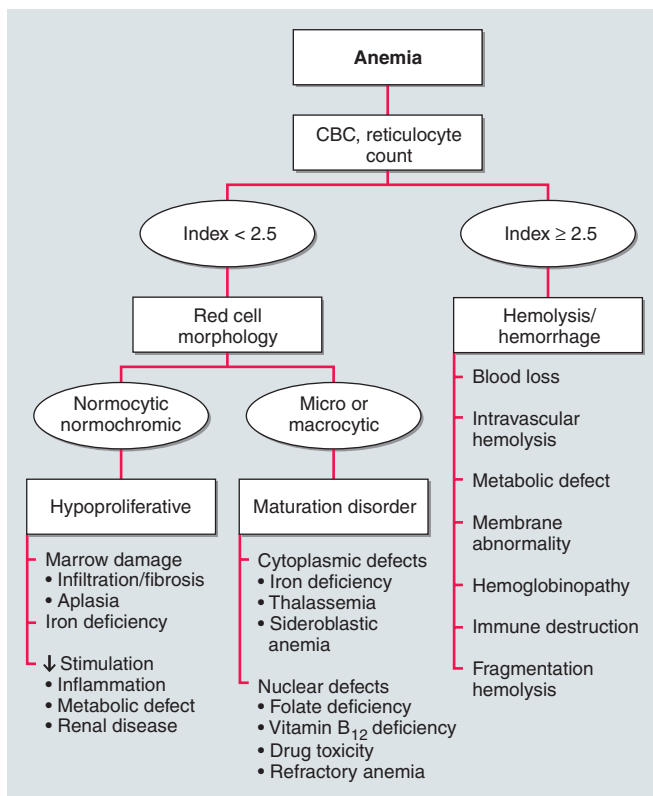
The functional classification of anemia has three major categories: (1) marrow production defects (*hypoproliferative*), (2) red cell maturation defects (*ineffective erythropoiesis*), and (3) decreased red cell survival (*blood loss/hemolysis*). The classification is shown in **Fig. 2-17**. A hypoproliferative anemia is typically seen with a low reticulocyte production index together with little or no change in red cell morphology (a normocytic, normochromic anemia) (Chap. 7). Maturation disorders typically have a slight to moderately elevated reticulocyte production index that is accompanied by either macrocytic (Chap. 9) or microcytic (Chaps. 7, 8) red cell indices. Increased red blood cell destruction secondary to hemolysis results in an increase in the reticulocyte production index to at least three times normal (Chap. 10), provided sufficient iron is available. Hemorrhagic anemia does not typically result in production indices of  $>2.0$ – $2.5$  times normal because of the limitations placed on expansion of the erythroid marrow by iron availability.

In the first branch point of the classification of anemia, a reticulocyte production index  $>2.5$  indicates that hemolysis is most likely. A reticulocyte production index

$<2$  indicates either a hypoproliferative anemia or maturation disorder. The latter two possibilities can often be distinguished by the red cell indices, by examination of the peripheral blood smear, or by a marrow examination. If the red cell indices are normal, the anemia is almost certainly hypoproliferative. Maturation disorders are characterized by ineffective red cell production and a low reticulocyte production index. Bizarre red cell shapes—macrocytes or hypochromic microcytes—are seen on the peripheral blood smear. With a hypoproliferative anemia, no erythroid hyperplasia is noted in the marrow, whereas patients with ineffective red cell production have erythroid hyperplasia and an M/E ratio  $<1:1$ .

### Hypoproliferative Anemias

At least 75% of all cases of anemia are hypoproliferative. A hypoproliferative anemia reflects absolute or relative marrow failure in which the erythroid marrow has not proliferated appropriately for the degree of anemia. Most hypoproliferative anemias are due to mild to moderate iron deficiency or inflammation. A hypoproliferative anemia can result from marrow damage, iron deficiency, or inadequate EPO stimulation. The last may reflect impaired renal function, suppression of EPO production by inflammatory cytokines such as interleukin 1, or reduced tissue needs for  $O_2$  from metabolic disease such as hypothyroidism. Only occasionally is the marrow unable to produce red cells at a normal rate, and this is most prevalent in patients with renal failure. With diabetes mellitus or myeloma, the EPO deficiency may be more marked than would be predicted by the degree of renal insufficiency. In general, hypoproliferative anemias are characterized by normocytic, normochromic red cells, although microcytic, hypochromic cells may be observed with mild iron deficiency or long-standing chronic inflammatory disease. The key laboratory tests in distinguishing between the various forms of hypoproliferative anemia include the serum iron and iron-binding capacity, evaluation of renal and thyroid function, a marrow biopsy or aspirate to detect marrow damage or infiltrative disease, and serum ferritin to assess iron stores. Occasionally, an iron stain of the marrow is needed to determine the pattern of iron distribution. Patients with the anemia of acute or chronic inflammation show a distinctive pattern of serum iron (low), TIBC (normal or low), percent transferrin saturation (low), and serum ferritin (normal or high). These changes in iron values are brought about by hepcidin, the iron regulatory hormone that is increased in inflammation (Chap. 7). A distinct pattern of results is noted in mild to moderate iron deficiency (low serum iron, high TIBC, low percent transferrin saturation, low serum ferritin) (Chap. 7). Marrow damage by drugs, such as the antiretrovirals used to treat HIV infection, infiltrative disease such as leukemia or lymphoma, or marrow



**FIGURE 2-17**  
The physiologic classification of anemia. CBC, complete blood count.

aplasia, can usually be diagnosed from the peripheral blood and bone marrow morphology. With infiltrative disease or fibrosis, a marrow biopsy is required.

### Maturation Disorders

The presence of anemia with an inappropriately low reticulocyte production index, macro- or microcytosis on smear, and abnormal red cell indices suggests a maturation disorder. Maturation disorders are divided into two categories: nuclear maturation defects, associated with macrocytosis and abnormal marrow development, and cytoplasmic maturation defects, associated with microcytosis and hypochromia usually from defects in hemoglobin synthesis. The inappropriately low reticulocyte production index is a reflection of the ineffective erythropoiesis that results from the destruction within the marrow of developing erythroblasts. Bone marrow examination shows erythroid hyperplasia.

Nuclear maturation defects result from vitamin B<sub>12</sub> or folic acid deficiency, drug damage, or myelodysplasia. Drugs that interfere with cellular DNA metabolism, such as methotrexate or alkylating agents, can produce a nuclear maturation defect. Alcohol, alone, is also capable of producing macrocytosis and a variable degree of anemia, but this is usually associated with folic acid deficiency. Measurements of folic acid and vitamin B<sub>12</sub> are key not only in identifying the specific vitamin deficiency but also because they reflect different pathogenetic mechanisms.

Cytoplasmic maturation defects result from severe iron deficiency or abnormalities in globin or heme synthesis. Iron deficiency occupies an unusual position in the classification of anemia. If the iron-deficiency anemia is mild to moderate, erythroid marrow proliferation is decreased and the anemia is classified as hypoproliferative. However, if the anemia is severe and prolonged, the erythroid marrow will become hyperplastic despite the inadequate iron supply, and the anemia will be classified as ineffective erythropoiesis with a cytoplasmic maturation defect. In either case, an inappropriately low reticulocyte production index, microcytosis, and a classic pattern of iron values make the diagnosis clear and easily distinguish iron deficiency from other cytoplasmic maturation defects such as the thalassemias. Defects in heme synthesis, in contrast to globin synthesis, are less common and may be acquired or inherited. Acquired abnormalities are usually associated with myelodysplasia, may lead to either a macro- or microcytic anemia, and are frequently associated with mitochondrial iron loading. In these cases, iron is taken up by the mitochondria of the developing erythroid cell but not incorporated into heme. The iron-encrusted mitochondria surround the nucleus of the erythroid cell, forming a ring. Based on the distinctive finding of so-called ringed sideroblasts on the marrow iron stain, patients are diagnosed as having a sideroblastic anemia—almost always reflecting myelodysplasia. Again,

### Blood Loss/Hemolytic Anemia

In contrast to anemias associated with an inappropriately low reticulocyte production index, hemolysis is associated with red cell production indices  $\geq 2.5$  times normal. The stimulated erythropoiesis is reflected in the blood smear by the appearance of increased numbers of polychromatophilic macrocytes. A marrow examination is rarely indicated if the reticulocyte production index is increased appropriately. The red cell indices are typically normocytic or slightly macrocytic, reflecting the increased number of reticulocytes. Acute blood loss is not associated with an increased reticulocyte production index because of the time required to increase EPO production and, subsequently, marrow proliferation. Subacute blood loss may be associated with modest reticulocytosis. Anemia from chronic blood loss presents more often as iron deficiency than with the picture of increased red cell production.

The evaluation of blood loss anemia is usually not difficult. Most problems arise when a patient presents with an increased red cell production index from an episode of acute blood loss that went unrecognized. The cause of the anemia and increased red cell production may not be obvious. The confirmation of a recovering state may require observations over a period of 2–3 weeks, during which the hemoglobin concentration will be seen to rise and the reticulocyte production index fall.

Hemolytic disease, although dramatic, is among the least common forms of anemia. The ability to sustain a high reticulocyte production index reflects the ability of the erythroid marrow to compensate for hemolysis and, in the case of extravascular hemolysis, the efficient recycling of iron from the destroyed red cells to support red cell production. With intravascular hemolysis, such as paroxysmal nocturnal hemoglobinuria, the loss of iron may limit the marrow response. The level of response depends on the severity of the anemia and the nature of the underlying disease process.

Hemoglobinopathies, such as sickle cell disease and the thalassemias, present a mixed picture. The reticulocyte index may be high but is inappropriately low for the degree of marrow erythroid hyperplasia (Chap. 8).

Hemolytic anemias present in different ways. Some appear suddenly as an acute, self-limited episode of intravascular or extravascular hemolysis, a presentation pattern often seen in patients with autoimmune hemolysis or with inherited defects of the Embden–Meyerhof pathway or the glutathione reductase pathway. Patients with inherited disorders of the hemoglobin molecule or red cell membrane generally have a lifelong clinical history typical of the disease process. Those with chronic hemolytic disease, such as hereditary spherocytosis, may actually present not with anemia but with a complication

20 stemming from the prolonged increase in red cell destruction such as symptomatic bilirubin gallstones or splenomegaly. Patients with chronic hemolysis are also susceptible to aplastic crises if an infectious process interrupts red cell production.

The differential diagnosis of an acute or chronic hemolytic event requires the careful integration of family history, the pattern of clinical presentation and—whether the disease is congenital or acquired—by a careful examination of the peripheral blood smear. Precise diagnosis may require more specialized laboratory tests, such as hemoglobin electrophoresis or a screen for red cell enzymes. Acquired defects in red cell survival are often immunologically mediated and require a direct or indirect antiglobulin test or a cold agglutinin titer to detect the presence of hemolytic antibodies or complement-mediated red cell destruction.

### **Rx Treatment:** **ANEMIA**

An overriding principle is to initiate treatment of mild to moderate anemia only when a specific diagnosis is made. Rarely, in the acute setting, anemia may be so severe that red cell transfusions are required before a specific diagnosis is made. Whether the anemia is of acute or gradual onset, the selection of the appropriate treatment is determined by the documented cause(s) of the anemia. Often, the cause of the anemia may be multifactorial. For example, a patient with severe rheumatoid arthritis who has been taking anti-inflammatory drugs may have a hypoproliferative anemia associated with chronic inflammation as well as chronic blood loss associated with intermittent gastrointestinal bleeding. In every circumstance, it is important to evaluate the patient's iron status fully before and during the treatment of any anemia. Transfusion is discussed in Chap. 12; iron therapy is discussed in Chap. 7; treatment of megaloblastic anemia is discussed in Chap. 9; treatment of other entities is discussed in their respective chapters (sickle cell anemia, Chap. 8; hemolytic anemias, Chap. 10; aplastic anemia and myelodysplasia, Chap. 11).

Therapeutic options for the treatment of anemias have expanded dramatically during the past 25 years. Blood component therapy is available and safe. Recombinant EPO as an adjunct to anemia management has transformed the lives of patients with chronic renal failure on dialysis and made some improvements in the quality of life of anemic cancer patients receiving chemotherapy. Improvements in the management of sickle cell crises and sickle cell anemia have also taken place. Eventually, patients with inherited disorders of globin synthesis or mutations in the globin gene, such as sickle cell disease, may benefit from the successful introduction of targeted genetic therapy.

## **POLYCYTHEMIA**

*Polycythemia* is defined as an increase in circulating red blood cells above normal. This increase may be real or only apparent because of a decrease in plasma volume (spurious or relative polycythemia). The term *erythrocytosis* may be used interchangeably with polycythemia, but some draw a distinction between them; erythrocytosis implies documentation of increased red cell mass, whereas polycythemia refers to any increase in red cells. Often patients with polycythemia are detected through an incidental finding of elevated hemoglobin or hematocrit levels. Concern that the hemoglobin level may be abnormally high is usually triggered at 170 g/L (17 g/dL) for men and 150 g/L (15 g/dL) for women. Hematocrit levels >50% in men or >45% in women may be abnormal. Hematocrits >60% in men and >55% in women are almost invariably associated with an increased red cell mass.

Historic features useful in the differential diagnosis include smoking history; living at high altitude; or a history of congenital heart disease, peptic ulcer disease, sleep apnea, chronic lung disease, or renal disease.

Patients with polycythemia may be asymptomatic or experience symptoms related to the increased red cell mass or an underlying disease process that leads to increased red cell production. The dominant symptoms from increased red cell mass are related to hyperviscosity and thrombosis (both venous and arterial) because the blood viscosity increases logarithmically at hematocrits >55%. Manifestations range from digital ischemia to Budd-Chiari syndrome with hepatic vein thrombosis. Abdominal thromboses are particularly common. Neurologic symptoms such as vertigo, tinnitus, headache, and visual disturbances may occur. Hypertension is often present. Patients with *polycythemia vera* may have aquagenic pruritus and symptoms related to hepatosplenomegaly. Patients may have easy bruising, epistaxis, or bleeding from the gastrointestinal tract. Patients with hypoxemia may develop cyanosis on minimal exertion or have headache, impaired mental acuity, and fatigue.

The physical examination usually reveals a ruddy complexion. Splenomegaly favors polycythemia vera as the diagnosis (Chap. 13). The presence of cyanosis or evidence of a right-to-left shunt suggests congenital heart disease presenting in the adult, particularly tetralogy of Fallot or Eisenmenger syndrome. Increased blood viscosity raises pulmonary artery pressure; hypoxemia can lead to increased pulmonary vascular resistance. Together these factors can produce cor pulmonale.

Polycythemia can be spurious (related to a decrease in plasma volume; Gaisböck's syndrome), primary, or secondary in origin. The secondary causes are all associated with increases in EPO levels: either a physiologically adapted appropriate elevation based on tissue hypoxia (lung disease, high altitude, CO poisoning, high-affinity

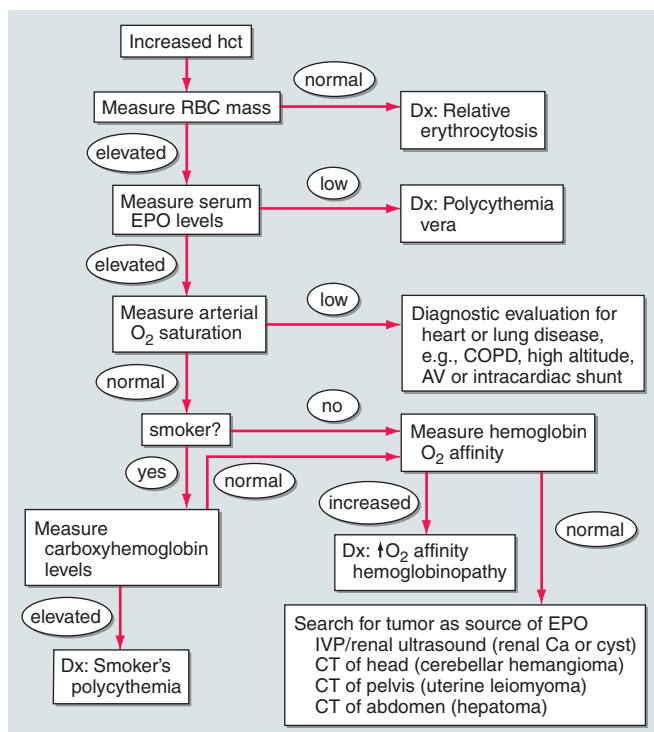
hemoglobinopathy) or an abnormal overproduction (renal cysts, renal artery stenosis, tumors with ectopic EPO production). A rare familial form of polycythemia is associated with normal EPO levels but hyperresponsive EPO receptors due to mutations.

### Approach to the Patient: POLYCYTHEMIA

As shown in [Fig. 2-18](#), the first step is to document the presence of an increased red cell mass using the principle of isotope dilution by administering  $^{51}\text{Cr}$ -labeled autologous red blood cells to the patient and sampling blood radioactivity over a 2-hour period. If the red cell mass is normal ( $<36$  mL/kg in men,  $<32$  mL/kg in women), the patient has spurious polycythemia. If the red cell mass is increased ( $>36$  mL/kg in men,  $>32$  mL/kg in women), serum EPO levels should be measured. If EPO levels are low or unmeasurable, the patient most likely has

polycythemia vera. Ancillary tests that support this diagnosis include elevated white blood cell count, increased absolute basophil count, and thrombocytosis. A mutation in *JAK-2* (Val617Phe), a key member of the cytokine intracellular signaling pathway, can be found in 70–95% of patients with polycythemia vera.

If serum EPO levels are elevated, one attempts to distinguish whether the elevation is a physiologic response to hypoxia or is related to autonomous production. Patients with low arterial  $\text{O}_2$  saturation ( $<92\%$ ) should be further evaluated for the presence of heart or lung disease, if they are not living at high altitude. Patients with normal  $\text{O}_2$  saturation who are smokers may have elevated EPO levels because of CO displacement of  $\text{O}_2$ . If carboxyhemoglobin (COHb) levels are high, the diagnosis is smoker's polycythemia. Such patients should be urged to stop smoking. Those who cannot stop smoking require phlebotomy to control their polycythemia. Patients with normal  $\text{O}_2$  saturation who do not smoke either have an abnormal hemoglobin that does not deliver  $\text{O}_2$  to the tissues (evaluated by finding elevated  $\text{O}_2$ -hemoglobin affinity) or have a source of EPO production that is not responding to the normal feedback inhibition. Further workup is dictated by the differential diagnosis of EPO-producing neoplasms. Hepatoma, uterine leiomyoma, and renal cancer or cysts are all detectable with abdominopelvic CT scans. Cerebellar hemangiomas may produce EPO, but they nearly always present with localizing neurologic signs and symptoms rather than polycythemia-related symptoms.



**FIGURE 2-18**

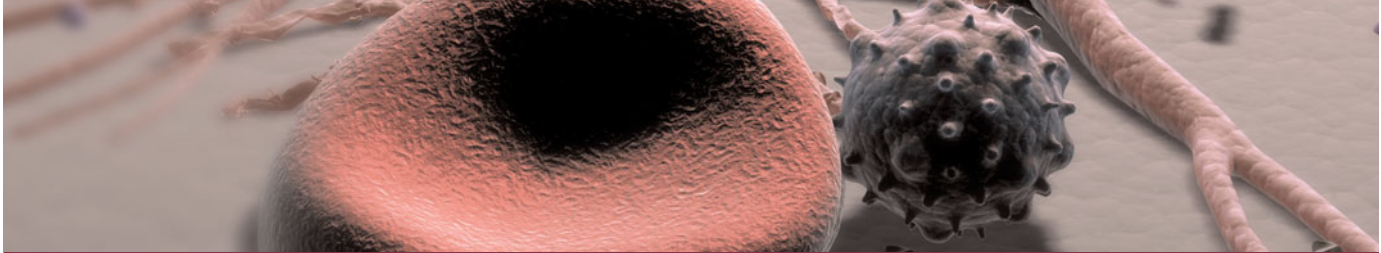
**An approach to diagnosing patients with polycythemia.** AV, atrioventricular; COPD, chronic obstructive pulmonary disease; EPO, erythropoietin; hct, hematocrit; IVP, intravenous pyelogram; RBC, red blood cell.

### ACKNOWLEDGMENT

Dr. Robert S. Hillman wrote this chapter in the 14th edition of *Harrison's Principles of Internal Medicine*, and elements of his chapter were retained here.

### FURTHER READINGS

- DEN ELZEN WP et al: Effect of anemia and comorbidity on functional status and mortality in old age: Results from the Leiden 85-plus study. *CMAJ* 181:151, 2009
- HILLMAN RS et al: *Hematology in Clinical Practice*, 4th ed. New York, McGraw-Hill, 2005
- NILSSON R et al: Discovery of genes essential for heme biosynthesis through large-scale gene expression analysis. *Cell Metab* 10:119, 2009
- PATNAIK MM, TEFFERI A: The complete evaluation of erythrocytosis: Congenital and acquired. *Leukemia* 23:834, 2009
- TERROVITIS JV et al: Anemia in heart failure: Pathophysiologic insights and treatment options. *Future Cardiol* 5:71, 2009



## CHAPTER 3

# BLEEDING AND THROMBOSIS

Barbara A. Konkle

■ Steps of Normal Hemostasis	22
Platelet Plug Formation	22
Fibrin Clot Formation	23
Antithrombotic Mechanisms	24
The Fibrinolytic System	25
■ Further Readings	31

The human hemostatic system provides a natural balance between procoagulant and anticoagulant forces. The procoagulant forces include platelet adhesion and aggregation and fibrin clot formation; anticoagulant forces include the natural inhibitors of coagulation and fibrinolysis. Under normal circumstances, hemostasis is regulated to promote blood flow; however, it is also prepared to clot blood rapidly to arrest blood flow and prevent exsanguination. After bleeding is successfully halted, the system remodels the damaged vessel to restore normal blood flow. The major components of the hemostatic system, which function in concert, are (1) platelets and other formed elements of blood, such as monocytes and red cells; (2) plasma proteins (the coagulation and fibrinolytic factors and inhibitors); and (3) the vessel wall itself.

### STEPS OF NORMAL HEMOSTASIS

#### PLATELET PLUG FORMATION

On vascular injury, platelets adhere to the site of injury, usually the denuded vascular intimal surface. Platelet adhesion is mediated primarily by von Willebrand factor (vWF), a large multimeric protein present in both plasma and in the extracellular matrix of the subendothelial vessel wall, which serves as the primary “molecular glue,” providing sufficient strength to withstand the high levels of shear stress that would tend to detach them with the flow of blood. Platelet adhesion is also

facilitated by direct binding to subendothelial collagen through specific platelet membrane collagen receptors.

Platelet adhesion results in subsequent platelet activation and aggregation. This process is enhanced and amplified by humoral mediators in plasma (e.g., epinephrine, thrombin); mediators released from activated platelets (e.g., adenosine diphosphate, serotonin); and vessel wall extracellular matrix constituents that come in contact with adherent platelets (e.g., collagen, vWF). Activated platelets undergo the release reaction, during which they secrete contents that further promote aggregation and inhibit the naturally anticoagulant endothelial cell factors. During platelet aggregation (platelet-platelet interaction), additional platelets are recruited from the circulation to the site of vascular injury, leading to the formation of an occlusive platelet thrombus. The platelet plug is anchored and stabilized by the developing fibrin mesh.

The platelet glycoprotein (Gp) IIb/IIIa ( $\alpha_{IIb}\beta_3$ ) complex is the most abundant receptor on the platelet surface. Platelet activation converts the normally inactive GpIIb/IIIa receptor into an active receptor, enabling binding to fibrinogen and vWF. Because the surface of each platelet has ~50,000 GpIIb/IIIa fibrinogen binding sites, numerous activated platelets recruited to the site of vascular injury can rapidly form an occlusive aggregate by means of a dense network of intercellular fibrinogen bridges. This receptor is the key mediator of platelet aggregation, so it has become an effective target for antiplatelet therapy.

## FIBRIN CLOT FORMATION

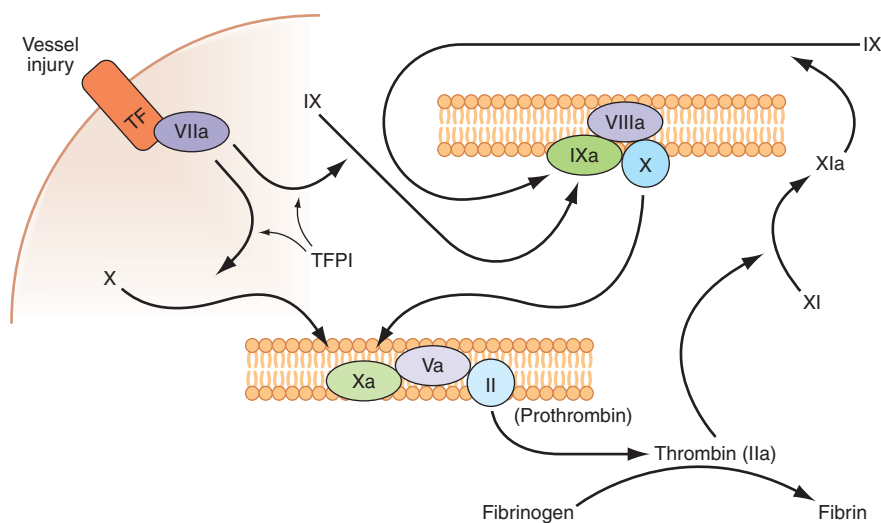
Plasma coagulation proteins (*clotting factors*) normally circulate in plasma in their inactive forms. The sequence of coagulation protein reactions that culminate in the formation of fibrin was originally described as a *waterfall* or a *cascade*. Two pathways of blood coagulation have been described in the past: the so-called extrinsic, or tissue factor, pathway and the so-called intrinsic, or contact activation, pathway. We now know that coagulation is normally initiated through tissue factor (TF) exposure and activation through the classic *extrinsic pathway* but with critically important amplification through elements of the classic *intrinsic pathway*, as illustrated in **Fig. 3-1**. These reactions take place on phospholipid surfaces, usually the activated platelet surface. Coagulation testing in the laboratory can reflect other influences due to the artificial nature of the *in vitro* systems used (see later).

The immediate trigger for coagulation is vascular damage that exposes blood to TF that is constitutively expressed on the surfaces of subendothelial cellular components of the vessel wall, such as smooth-muscle cells and fibroblasts. TF is also present in circulating microparticles, presumably shed from cells including monocytes and platelets. TF binds the serine protease factor VIIa; the complex activates factor X to factor Xa. Alternatively, the complex can indirectly activate factor X by initially converting factor IX to factor IXa, which then activates factor X. The participation of factor XI in hemostasis does not depend on its activation by factor

XIIa but rather on its positive feedback activation by thrombin. Thus factor XIa functions in the propagation and amplification, rather than in the initiation, of the coagulation cascade.

Factor Xa, which can be formed through the actions of either the TF/factor VIIa complex or factor IXa (with factor VIIIa as a cofactor), converts prothrombin to thrombin, the pivotal protease of the coagulation system. The essential cofactor for this reaction is factor Va. Like the homologous factor VIIIa, factor Va is produced by thrombin-induced limited proteolysis of factor V. Thrombin is a multifunctional enzyme that converts soluble plasma fibrinogen to an insoluble fibrin matrix. Fibrin polymerization involves an orderly process of intermolecular associations (**Fig. 3-2**). Thrombin also activates factor XIII (fibrin-stabilizing factor) to factor XIIIa, which covalently cross-links and thereby stabilizes the fibrin clot.

The assembly of the clotting factors on activated cell membrane surfaces greatly accelerates their reaction rates and also serves to localize blood clotting to sites of vascular injury. The critical cell membrane components, acidic phospholipids, are not normally exposed on resting cell membrane surfaces. However, when platelets, monocytes, and endothelial cells are activated by vascular injury or inflammatory stimuli, the procoagulant head groups of the membrane anionic phospholipids become translocated to the surfaces of these cells or released as part of microparticles, making them available to support and promote the plasma coagulation reactions.

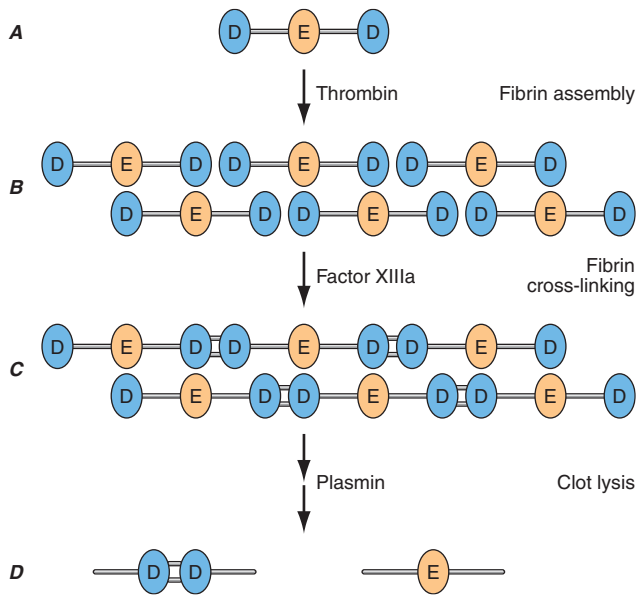


**FIGURE 3-1**

**Coagulation is initiated by tissue factor (TF) exposure,** which, with factor (F)VIIa, activates FIX and FX, which in turn, with FVIII and FV as cofactors, respectively, results in thrombin formation and subsequent conversion of fibrinogen to fibrin. Thrombin activates FXI, FVIII, and FV, amplifying the coagulation signal. Once the TF/FVIIa/FXa complex is formed,

tissue factor pathway inhibitor (TFPI) inhibits the TF/FVIIa pathway, making coagulation dependent on the amplification loop through FIX/FVIII. Coagulation requires calcium (not shown) and takes place on phospholipid surfaces, usually the activated platelet membrane.



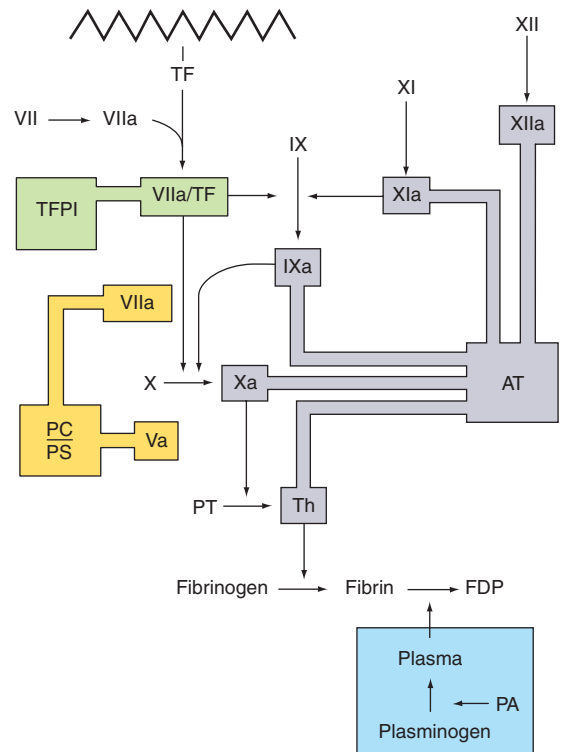
**FIGURE 3-2**

**Fibrin formation and dissolution.** **A.** Fibrinogen is a trinodular structure consisting of 2 D domains and 1 E domain. Thrombin activation results in an ordered lateral assembly of protofibrils (**B**) with noncovalent associations. FXIIIa cross-links the D domains on adjacent molecules (**C**). Fibrin and fibrinogen (not shown) lysis by plasmin occurs at discrete sites and results in intermediary fibrin(ogen) degradation products (not shown). D-Dimers are the product of complete lysis of fibrin, maintaining the cross-linked D domains.

## ANTITHROMBOTIC MECHANISMS

Several physiologic antithrombotic mechanisms act in concert to prevent clotting under normal circumstances. These mechanisms operate to preserve blood fluidity and limit blood clotting to specific focal sites of vascular injury. Endothelial cells have many antithrombotic effects. They produce prostacyclin, nitric oxide, and ectoADPase/CD39, which act to inhibit platelet binding, secretion, and aggregation. Endothelial cells produce anticoagulant factors including heparan proteoglycans, antithrombin, TF pathway inhibitor, and thrombomodulin. They also activate fibrinolytic mechanisms through the production of tissue plasminogen activator 1, urokinase, plasminogen activator inhibitor, and annexin-2. **Figure 3-3** shows the sites of action of the major physiologic antithrombotic pathways.

Antithrombin (or antithrombin III) is the major plasma protease inhibitor of thrombin and the other clotting factors in coagulation. Antithrombin neutralizes thrombin and other activated coagulation factors by forming a complex between the active site of the enzyme and the reactive center of antithrombin. The rate of formation of these inactivating complexes

**FIGURE 3-3**

**Sites of action of the four major physiologic antithrombotic pathways:** antithrombin (AT); protein C/S (PC/PS); tissue factor pathway inhibitor (TFPI); and the fibrinolytic system, consisting of plasminogen, plasminogen activator (PA), and plasmin. PT, prothrombin; Th, thrombin; FDP, fibrin(ogen) degradation products. [Modified from BA Konkle, Al Schafer, in DP Zipes et al (eds): *Braunwald's Heart Disease, 7th ed.* Philadelphia, Saunders, 2005.]

increases by a factor of several thousand in the presence of heparin. Antithrombin inactivation of thrombin and other activated clotting factors occurs physiologically on vascular surfaces, where glycosaminoglycans, including heparan sulfates, are present to catalyze these reactions. Inherited quantitative or qualitative deficiencies of antithrombin lead to a lifelong predisposition to venous thromboembolism.

Protein C is a plasma glycoprotein that becomes an anticoagulant when it is activated by thrombin. The thrombin-induced activation of protein C occurs physiologically on thrombomodulin, a transmembrane proteoglycan binding site for thrombin on endothelial cell surfaces. The binding of protein C to its receptor on endothelial cells places it in proximity to the thrombin-thrombomodulin complex, therefore enhancing its activation efficiency. Activated protein C acts as an anticoagulant by cleaving and inactivating activated factors V and VIII. This reaction is accelerated by a cofactor, protein S, which, like protein C, is a glycoprotein that undergoes vitamin K-dependent posttranslational modification. Quantitative or qualitative deficiencies

of protein C or protein S, or resistance to the action of activated protein C by a specific mutation at its target cleavage site in factor Va (factor V Leiden), lead to hypercoagulable states.

Tissue factor pathway inhibitor (TFPI) is a plasma protease inhibitor that regulates the TF-induced extrinsic pathway of coagulation. TFPI inhibits the TF/FVIIa/FXa complex, essentially turning off the TF/FVIIa initiation of coagulation, which then becomes dependent on the “amplification loop” via FXI and FVIII activation by thrombin. TFPI is bound to lipoprotein and can also be released by heparin from endothelial cells, where it is bound to glycosaminoglycans, and from platelets. The heparin-mediated release of TFPI may play a role in the anticoagulant effects of unfractionated and low-molecular-weight heparins.

## THE FIBRINOLYTIC SYSTEM

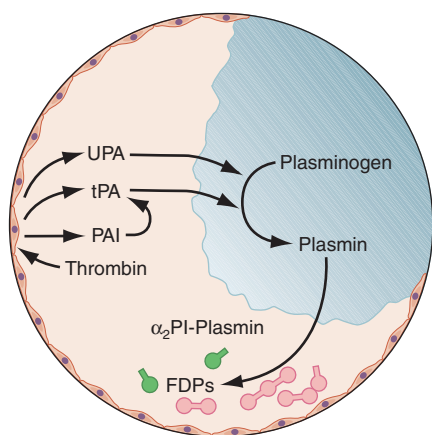
Any thrombin that escapes the inhibitory effects of the physiologic anticoagulant systems is available to convert fibrinogen to fibrin. In response, the endogenous fibrinolytic system is then activated to dispose of intravascular fibrin and thereby maintain or reestablish the patency of the circulation. Just as thrombin is the key protease enzyme of the coagulation system, plasmin is the major protease enzyme of the fibrinolytic system, acting to digest fibrin to fibrin degradation products. **Figure 3-4** shows the general scheme of fibrinolysis.

The plasminogen activators, tissue plasminogen activator (tPA) and urokinase plasminogen activator (uPA), cleave the Arg560-Val561 bond of plasminogen to

generate the active enzyme plasmin. The lysine-binding sites of plasmin (and plasminogen) permit it to bind to fibrin, so that physiologic fibrinolysis is “fibrin specific.” Both plasminogen (through its lysine-binding sites) and tPA possess specific affinity for fibrin and thereby bind selectively to clots. The assembly of a ternary complex, consisting of fibrin, plasminogen, and tPA, promotes the localized interaction between plasminogen and tPA and greatly accelerates the rate of plasminogen activation to plasmin. Moreover, partial degradation of fibrin by plasmin exposes new plasminogen and tPA binding sites in carboxy-terminus lysine residues of fibrin fragments to enhance these reactions further. This creates a highly efficient mechanism to generate plasmin focally on the fibrin clot, which then becomes plasmin’s substrate for digestion to fibrin degradation products.

Plasmin cleaves fibrin at distinct sites of the fibrin molecule leading to the generation of characteristic fibrin fragments during the process of fibrinolysis (Fig. 3-2). The sites of plasmin cleavage of fibrin are the same as those in fibrinogen. However, when plasmin acts on covalently cross-linked fibrin, D-dimers are released; hence D-dimers can be measured in plasma as a relatively specific test of fibrin (rather than fibrinogen) degradation. D-Dimer assays can be used as sensitive markers of blood clot formation, and some have been validated for clinical use to exclude the diagnosis of deep vein thrombosis (DVT) and pulmonary embolism in selected populations.

Physiologic regulation of fibrinolysis occurs primarily at two levels: (1) plasminogen activator inhibitors (PAIs), specifically PAI1 and PAI2, inhibit the physiologic plasminogen activators; and (2)  $\alpha_2$  antiplasmin inhibits plasmin. PAI1 is the primary inhibitor of tPA and uPA in plasma.  $\alpha_2$  Antiplasmin is the main inhibitor of plasmin in human plasma, inactivating any nonfibrin clot-associated plasmin.



**FIGURE 3-4**

**A schematic diagram of the fibrinolytic system.** Tissue plasminogen activator (tPA) is released from endothelial cells, binds the fibrin clot, and activates plasminogen to plasmin. Excess fibrin is degraded by plasmin to distinct degradation products (FDPs). Any free plasmin is complexed with  $\alpha_2$ -antiplasmin ( $\alpha_2$ PI).

### Approach to the Patient: BLEEDING AND THROMBOSIS

**CLINICAL PRESENTATION** Disorders of hemostasis may be either inherited or acquired. A detailed personal and family history is key in determining the chronicity of symptoms and the likelihood of the disorder being inherited, and it provides clues to underlying conditions that have contributed to the bleeding or thrombotic state. In addition, the history can give clues as to the etiology by determining (1) the bleeding (mucosal and/or joint) or thrombosis (arterial and/or venous) site, and (2) whether an underlying bleeding or clotting tendency was enhanced by another medical condition or the introduction of medications or dietary supplements.

**History of Bleeding** A history of bleeding is the most important predictor of bleeding risk. In evaluating a

patient for a bleeding disorder, a history of at-risk situations, including the response to past surgeries, should be assessed. Does the patient have a history of spontaneous or trauma/surgery-induced bleeding? Spontaneous hemarthroses are a hallmark of moderate and severe factors VIII and IX deficiency and, in rare circumstances, of other clotting factor deficiencies. Mucosal bleeding symptoms are more suggestive of underlying platelet disorders or von Willebrand's disease (vWD), termed *disorders of primary hemostasis or platelet plug formation*. **Table 3-1** shows the disorders affecting primary hemostasis.

The development of bruises (ecchymoses) after trauma is normal; however, an exaggerated response to trauma may be an indication of an underlying bleeding disorder. Ecchymoses presenting without known trauma, particularly on the trunk, and especially large ecchymoses, >2 in. in diameter, may be a sign of an underlying bleeding disorder. The introduction of medications or nutritional supplements with platelet inhibitory activity often enhance bruising and bleeding in a patient with an underlying bleeding disorder. Easy bruising can also be a sign of medical conditions in which there is no identifiable coagulopathy; instead, the conditions are caused by an abnormality of blood vessels or their supporting tissues. In Ehlers-Danlos syndrome there may be posttraumatic bleeding and a history of joint hyperextensibility. Cushing's syndrome, chronic steroid use, and aging result in changes in skin and subcutaneous tissue, and subcutaneous bleeding occurs in response

to minor trauma. The latter has been termed *senile purpura*.

Epistaxis is a common symptom, particularly in children and in dry climates, and it may not reflect an underlying bleeding disorder. However, it is the most common symptom in hereditary hemorrhagic telangiectasia and in boys with vWD. Clues that epistaxis is a symptom of an underlying bleeding disorder include lack of seasonal variation and bleeding that requires medical evaluation or treatment, including cauterization. Bleeding with eruption of primary teeth is seen in children with more severe bleeding disorders, such as moderate and severe hemophilia. It is uncommon in children with mild bleeding disorders. Patients with disorders of primary hemostasis (platelet adhesion) do have increased bleeding after dental cleanings and other procedures that involve gum manipulation.

*Menorrhagia* is defined quantitatively as a loss of >80 mL of blood per cycle, based on blood loss required to produce iron-deficiency anemia. A complaint of heavy menses is subjective and has a poor correlation with excessive blood loss. Predictors of menorrhagia include bleeding resulting in iron-deficiency anemia or a need for blood transfusion, excessive pad or tampon use, menses lasting >8 days, passage of clots, bleeding through protection, or flooding at night. Menorrhagia is a common symptom in women with underlying bleeding disorders and reported in most women with vWD and factor XI deficiency and in symptomatic carriers of hemophilia A. Women with underlying bleeding disorders are more likely to have other bleeding symptoms, including bleeding after dental extractions, postoperative bleeding, and postpartum bleeding, and they are much more likely to have menorrhagia beginning at menarche than women with menorrhagia due to other causes.

Postpartum hemorrhage is a common symptom in women with underlying bleeding disorders. This occurs most commonly in the first 48 hours after delivery, but it may also be manifest by prolonged or excessive bleeding after discharge from the hospital. Women with a history of postpartum hemorrhage have a high risk of recurrence with subsequent pregnancies. Rupture of ovarian cysts with intra-abdominal hemorrhage has also been reported in women with underlying bleeding disorders.

Tonsillectomy is a major hemostatic challenge because intact hemostatic mechanisms are essential to prevent excessive bleeding from the tonsillar bed. Bleeding may occur early after surgery or after ~7 days postoperatively, with loss of the eschar at the operative site. Similar delayed bleeding is seen after colonic polyp resection by cautery. Gastrointestinal (GI)

**TABLE 3-1****PRIMARY HEMOSTATIC (PLATELET PLUG) DISORDERS**

Defects of platelet adhesion
von Willebrand's disease
Bernard-Soulier syndrome (absence of dysfunction of GpIb-IX-V)
Defects of platelet aggregation
Glanzmann's thrombasthenia (absence or dysfunction of GpIIb/IIIa)
Afibrinogenemia
Defects of platelet secretion
Decreased cyclooxygenase activity
Drug-induced (aspirin, nonsteroidal anti-inflammatory agents)
Inherited
Granule storage pool defects
Inherited
Acquired
Nonspecific drug effects
Uremia
Platelet coating (e.g., paraprotein, penicillin)
Defect of platelet coagulant activity
Scott's syndrome

bleeding and hematuria are usually due to underlying pathology, and procedures to identify and treat the bleeding site should be undertaken, even in patients with known bleeding disorders. vWD, particularly types 2 and 3, has been associated with angiodysplasia of the bowel and GI bleeding.

Hemarthroses and spontaneous muscle hematomas are characteristic of moderate or severe congenital factor VIII or IX deficiency. They can also be seen in moderate and severe deficiencies of fibrinogen, prothrombin, and of factors V, VII, and X. Spontaneous hemarthroses occur rarely in other bleeding disorders except for severe vWD, with associated FVIII levels <5%. Muscle and soft tissue bleeds are also common in acquired FVIII deficiency. Bleeding into a joint results in severe pain and swelling, as well as loss of function, but is rarely associated with discoloration from bruising around the joint. Life-threatening sites of bleeding include bleeding into the oropharynx, where bleeding can obstruct the airway, into the central nervous system, and into the retroperitoneum. Central nervous system bleeding is the major cause of bleeding-related deaths in patients with severe congenital factor deficiencies.

**Prohemorrhagic Effects of Medications and Dietary Supplements** Aspirin and other nonsteroidal anti-inflammatory drugs (NSAIDs) that inhibit cyclooxygenase 1 impair primary hemostasis and may exacerbate bleeding from another cause or even unmask a previously occult mild bleeding disorder such as vWD. All NSAIDs, however, can precipitate GI bleeding, which may be more severe in patients with underlying bleeding disorders. The aspirin effect on platelet function as assessed by aggregometry can persist for up to 7 days, although it has frequently returned to normal by 3 days after the last dose. The effect of other NSAIDs is shorter because the inhibitor effect is reversed when the drug is removed.

Many herbal supplements can impair hemostatic function (Table 3-2). Some have been more convincingly associated with a bleeding risk than others. Fish oil or concentrated omega 3 fatty acid supplements impair platelet activation. They alter platelet biochemistry to produce more PGI<sub>3</sub>, a more potent platelet inhibitor than prostacyclin (PGI<sub>2</sub>), and more thromboxane A<sub>3</sub>, a less potent platelet activator than thromboxane A<sub>2</sub>. In fact, diets naturally rich in omega 3 fatty acids can result in a prolonged bleeding time and abnormal platelet aggregation studies, but the actual associated bleeding risk is unclear. Vitamin E appears to inhibit protein kinase C-mediated platelet aggregation and nitric oxide production. In patients with unexplained bruising or bleeding, it is prudent to review

TABLE 3-2

### HERBAL SUPPLEMENTS ASSOCIATED WITH INCREASED BLEEDING

Herbs with Potential Anti-Platelet Activity
Ginkgo ( <i>Ginkgo biloba</i> L.)
Garlic ( <i>Allium sativum</i> )
Bilberry ( <i>Vaccinium myrtillus</i> )
Ginger ( <i>Zingiber officinale</i> )
Dong quai ( <i>Angelica sinensis</i> )
Feverfew ( <i>Tanacetum parthenium</i> )
Asian Ginseng ( <i>Panax ginseng</i> )
American Ginseng ( <i>Panax quinquefolius</i> )
Siberian ginseng/eleuthero ( <i>Eleutherococcus senticosus</i> )
Tumeric ( <i>Curcuma longa</i> )
Meadowsweet ( <i>Filipendula ulmaria</i> )
Willow ( <i>Salix</i> spp.)
Coumarin-Containing Herbs
Motherwort ( <i>Leonurus cardiaca</i> )
Chamomile ( <i>Matricaria recutita</i> , <i>Chamaemelum mobile</i> )
Horse chestnut ( <i>Aesculus hippocastanum</i> )
Red clover ( <i>Trifolium pratense</i> )
Fenugreek ( <i>Trigonella foenum-graecum</i> )

any new medications or supplements and discontinue those that may be associated with bleeding.

#### Underlying Systemic Diseases that Cause or Exacerbate a Bleeding Tendency

Acquired bleeding disorders are commonly secondary to, or associated with, systemic disease. The clinical evaluation of a patient with a bleeding tendency must therefore include a thorough assessment for evidence of underlying disease. Bruising or mucosal bleeding may be the presenting complaint in liver disease, severe renal impairment, hypothyroidism, paraproteinemias or amyloidosis, and conditions causing bone marrow failure. All coagulation factors are synthesized in the liver, and hepatic failure results in combined factor deficiencies. This situation is often compounded by thrombocytopenia from splenomegaly due to portal hypertension. Coagulation factors II, VII, IX, X and proteins C, S, and Z depend on vitamin K for posttranslational modification. Although vitamin K is required in both procoagulant and anticoagulant processes, the phenotype of vitamin K deficiency or the warfarin effect on coagulation is bleeding.

The normal blood platelet count is 150,000–450,000/μL. Thrombocytopenia results from decreased production, increased destruction, and/or sequestration. Although the bleeding risk varies somewhat by the reason for the thrombocytopenia, bleeding rarely occurs in isolated thrombocytopenia at counts <50,000/μL and usually not until <10,000–20,000/μL. Coexisting coagulopathies, as seen in liver failure or

disseminated coagulation; infection, platelet-inhibitory drugs, and underlying medical conditions, can all increase the risk of bleeding in the thrombocytopenic patient. Most procedures can be performed in patients with a platelet count of 50,000/ $\mu$ L. The level needed for major surgery will depend on the type of surgery and the patients' underlying medical state, although a count of  $\sim$ 80,000/ $\mu$ L is likely sufficient.

**History of Thrombosis** The risk of thrombosis, like that of bleeding, is influenced by both genetic and environmental influences. The major risk factor for arterial thrombosis is atherosclerosis; those for venous thrombosis are immobility, surgery, underlying medical conditions such as malignancy, medications such as hormonal therapy, obesity, and genetic predispositions. **Table 3-3** lists the factors that increase risks for venous and both venous and arterial thromboses.

The most important point in a history related to venous thrombosis is whether the thrombotic event was idiopathic (meaning there was no clear precipitating factor) or was a precipitated event. In patients without underlying malignancy, having an idiopathic event is the strongest predictor of recurrence of venous thromboembolism. In patients who have a vague history of

thrombosis, a history of being treated with warfarin suggests a past DVT. Age is an important risk factor for venous thrombosis; the risk of DVT increases per decade, with an approximate incidence of 1/100,000 per year in early childhood to 1/200 per year among octogenarians. Family history is helpful in determining if there is a genetic predisposition and how strong that predisposition appears to be.

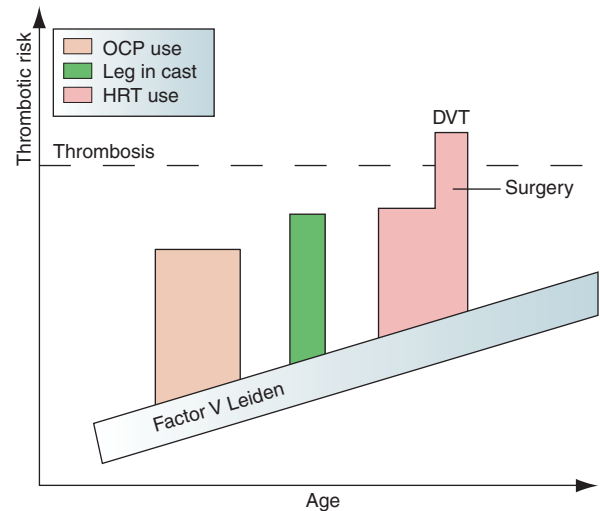
A genetic thrombophilia that confers a relatively small increased risk, such as being a heterozygote for the prothrombin G20210A or factor V Leiden mutation, may be a relatively minor determinant of risk in an elderly individual undergoing a high-risk surgical procedure. As shown in **Fig. 3-5**, a thrombotic event often has more than one contributing factor. Predisposing factors must be carefully assessed to determine the risk of recurrent thrombosis, and with consideration of the patient's bleeding risk, to determine the length of anticoagulation. Similar consideration should be given to determining the need to test the patient and family members for genetic thrombophilias.

**TABLE 3-3**

RISK FACTORS FOR THROMBOSIS	
VENOUS	VENOUS AND ARTERIAL
Inherited	Inherited
Factor V Leiden	Homocystinuria
Prothrombin G20210A	Dysfibrinogenemia
Antithrombin deficiency	Mixed (inherited and acquired)
Protein C deficiency	Hyperhomocysteinemia
Protein S deficiency	Acquired
Elevated FVIII	Malignancy
Acquired	Antiphospholipid antibody syndrome
Age	Hormonal therapy
Previous thrombosis	Polycythemia vera
Immobilization	Essential thrombocythemia
Major surgery	Paroxysmal nocturnal hemoglobinuria
Pregnancy & puerperium	Thrombotic thrombocytopenic purpura
Hospitalization	Heparin-induced thrombocytopenia
Obesity	Disseminated intravascular coagulation
Infection	
APC resistance, nongenetic	
Unknown <sup>a</sup>	
Elevated factor II, IX, XI	
Elevated TAFI levels	
Low levels of TFPI	

<sup>a</sup>Unknown whether risk is inherited or acquired.

**Note:** APC, activated protein C; TAFI, thrombin-activatable fibrinolysis inhibitor; TFPI, tissue factor pathway inhibitor.

**FIGURE 3-5**

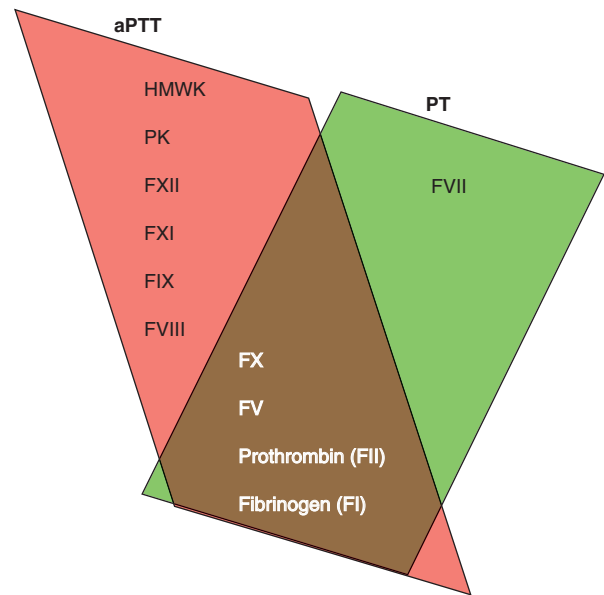
**Thrombotic risk over time.** Shown schematically is an individual's thrombotic risk over time. An underlying factor V Leiden mutation provides a "theoretically" constant increased risk. The thrombotic risk increases with age and, intermittently, with oral contraceptive pill (OCP) or hormone replacement therapy (HRT) use; other events may increase the risk further. At some point the cumulative risk may increase to the threshold for thrombosis and result in deep vein thrombosis (DVT). Note: The magnitude and duration of risk portrayed in the figure is meant for example only and may not precisely reflect the relative risk determined by clinical study. [From BA Konkle, A Schafer, in DP Zipes et al (eds): *Braunwald's Heart Disease*, 7th ed. Philadelphia, Saunders, 2005; modified with permission from FR Rosendaal: *Venous thrombosis: A multicausal disease*. *Lancet* 353:1167, 1999.]

**LABORATORY EVALUATION** Careful history taking and clinical examination are essential components in the assessment of bleeding and thrombotic risk. The use of laboratory tests of coagulation complement but cannot substitute for clinical assessment. No test provides a global assessment of hemostasis. The bleeding time has been used to assess bleeding risk; however, it does not predict bleeding risk with surgery and is not recommended for this indication. The PFA-100, an instrument that measures platelet-dependent coagulation under flow conditions, is more sensitive and specific for platelet disorders and vWD than the bleeding time; however, it is not sensitive enough to rule out underlying mild bleeding disorders. Also, it has not been evaluated prospectively to determine its usefulness in predicting bleeding risk, although such studies are underway.

For routine preoperative and preprocedure testing, an abnormal prothrombin time (PT) may detect liver disease or vitamin K deficiency that had not been previously appreciated. Studies have not confirmed the usefulness of an activated partial thromboplastin time (aPTT) in preoperative evaluations in patients with a negative bleeding history. The primary use of coagulation testing should be to confirm the presence and type of bleeding disorder in a patient with a suspicious clinical history.

Because of the nature of coagulation assays, proper sample acquisition and handling is critical to obtaining valid results. In patients with abnormal coagulation assays who have no bleeding history, repeat studies with attention to these factors frequently results in normal values. Most coagulation assays are performed in sodium citrate anticoagulated plasma that is recalcified for the assay. Because the anticoagulant is in liquid solution and needs to be added to blood in proportion to the plasma volume, incorrectly filled or inadequately mixed blood collection tubes will give erroneous results. Vacutainer tubes should be filled to >90% of the recommended fill, which is usually denoted by a line on the tube. An elevated hematocrit (>55%) can result in a false value due to a decreased plasma-to-anticoagulant ratio.

**Screening Assays** The most commonly used screening tests are the PT, aPTT, and platelet count. The PT assesses factors I (fibrinogen), II (prothrombin), V, VII, and X (Fig. 3–6). The PT measures the time for clot formation of the citrated plasma after recalcification and addition of thromboplastin, a mixture of TF and phospholipids. The sensitivity of the assay varies by the source of thromboplastin. To adjust for this variability, the overall sensitivity of different thromboplastins to reduction of the vitamin K-dependent clotting factors II, VII, IX, and X in anticoagulated patients is now expressed as the International Sensitivity Index



**FIGURE 3-6** Coagulation factor activity tested in the activated partial thromboplastin time (aPTT) in red and prothrombin time (PT) in green, or both. HMWK, high-molecular-weight kininogen; PK, prekallikrein; F, factor.

(ISI). An inverse relationship exists between the ISI and thromboplastin sensitivity. The international normalized ratio (INR) is then determined based on the formula:  $INR = (PT_{\text{patient}}/PT_{\text{normal mean}})^{ISI}$ .

Although the INR was developed to assess anticoagulation due to reduction of vitamin K-dependent coagulation factors, it is commonly used in the evaluation of patients with liver disease. This measure provides a system for comparing values from testing performed at different laboratories. However, because progressive liver failure is associated with variable changes in coagulation factors, the degree of prolongation of either the PT or the INR only roughly predicts the bleeding risk. Thrombin generation has been shown to be normal in many patients with mild to moderate liver dysfunction. The PT only measures one aspect of hemostasis affected by liver dysfunction, so we likely overestimate the bleeding risk of a mildly elevated INR in this setting.

The aPTT assesses the intrinsic and common coagulation pathways, factors XI, IX, VIII, X, V, II, fibrinogen, and also prekallikrein, high-molecular-weight kininogen, and factor XII (Fig. 3–6). The aPTT reagent contains phospholipids derived from either animal or vegetable sources that function as a platelet substitute in the coagulation pathways and includes an activator of the intrinsic coagulation system, such as ellagic acid or the particulate activators kaolin, celite, or micronized silica.

The phospholipid composition of aPTT reagents varies, which influences the sensitivity of individual reagents to clotting factor deficiencies and to inhibitors such as heparin and lupus anticoagulants. Thus aPTT results vary from one laboratory to another, and the normal range in the laboratory where the testing occurs should be used in the interpretation. Local laboratories can relate their aPTT values to therapeutic heparin anticoagulation by correlating aPTT values with direct measurements of heparin activity (anti-Xa or protamine titration assays) in samples from heparinized patients, although correlation between these assays is often poor. The aPTT reagent varies in sensitivity to individual factor deficiencies and usually becomes prolonged with individual factor deficiencies of 30-50%. **Table 3-4** show the relationship between defects in secondary hemostasis (fibrin formation) and coagulation test abnormalities.

**Mixing Studies** Mixing studies are used to evaluate a prolonged aPTT or, less commonly PT, to distinguish between a factor deficiency and an inhibitor. In this assay, normal plasma and patient plasma are mixed in a 50:50 ratio, and the aPTT or PT is determined immediately and after incubation at 37°C for varying times, typically 30, 60, and/or 120 minutes. With isolated factor deficiencies, the aPTT will correct with mixing and stay corrected with incubation. With aPTT prolongation due to a lupus anticoagulant, the mixing and incubation will show no correction. In acquired neutralizing factor antibodies, such as an acquired factor VIII inhibitor, the initial assay may or may not correct immediately after mixing but will prolong or remain prolonged with incubation at 37°C. Failure to correct with mixing can also be due to the presence of other inhibitors or interfering substances such as heparin, fibrin split products, and paraproteins.

**Specific Factor Assays** Decisions to proceed with specific clotting factor assays will be influenced by the clinical situation and the results of coagulation screening tests. Precise diagnosis and effective management of inherited and acquired coagulation deficiencies necessitate quantitation of the relevant factors. When bleeding is severe, specific assays are often urgently required to guide appropriate therapy. Individual factor assays are usually performed as modifications of the mixing study, where the patient's plasma is mixed with plasma deficient in the factor being studied. This will correct all factor deficiencies to >50%, thus making prolongation of clot formation due to a factor deficiency dependent on the factor missing from the added plasma.

**Testing for Antiphospholipid Antibodies** Antibodies to phospholipids (cardiolipin) or phospholipid-binding

**TABLE 3-4****HEMOSTATIC DISORDERS AND COAGULATION TEST ABNORMALITIES**

Prolonged activated partial thromboplastin time (aPTT)
No clinical bleeding— $\gamma$ factors XII, high-molecular-weight kininogen, protein kinase
Variable, but usually mild, bleeding— $\downarrow$ factor XI, mild $\downarrow$ FVIII and FIX
Frequent, severe bleeding—severe deficiencies of FVIII and FIX
Heparin
Prolonged prothrombin time (PT)
Factor VII deficiency
Vitamin K deficiency—early
Warfarin anticoagulation
Prolonged aPTT and PT
Factor II, V or X deficiency
Vitamin K deficiency—late
Direct thrombin inhibitors
Prolonged thrombin time
Heparin or heparin-like inhibitors
Mild or no bleeding—dysfibrinogenemia
Frequent, severe bleeding—afibrinogenemia
Prolonged PT and/or aPTT not correct with mixing with normal plasma
Bleeding: specific factor inhibitor
No symptoms, or clotting and/or pregnancy loss: lupus anticoagulant
Disseminated intravascular coagulation
Heparin or direct thrombin inhibitor
Abnormal clot solubility
Factor XIII deficiency
Inhibitors or defective cross-linking
Rapid clot lysis
Deficiency of $\alpha_2$ -antiplasmin or plasminogen activator inhibitor 1
Treatment with fibrinolytic therapy

proteins ( $\beta_2$ -microglobulin and others) are detected by enzyme-linked immunosorbent assay. When these antibodies interfere with phospholipid-dependent coagulation tests, they are termed *lupus anticoagulants*. The aPTT has variable sensitivity to lupus anticoagulants, depending in part on the aPTT reagents used. An assay using a sensitive reagent has been termed an *LA-PTT*. The dilute Russell viper venom test (dRVVT) and the tissue thromboplastin time (TTI) are modifications of standard tests with the phospholipid reagent decreased, thus increasing the sensitivity to antibodies that interfere with the phospholipid component. The tests, however, are not specific for lupus anticoagulants because factor deficiencies or other inhibitors also result in prolongation. Documentation of a lupus anticoagulant requires not only prolongation of a phospholipid-dependent coagulation test but also lack of correction when mixed with normal plasma and

correction with the addition of activated platelet membranes or certain phospholipids, e.g., hexagonal phase.

**Other Coagulation Tests** The thrombin time and the reptilase time measure fibrinogen conversion to fibrin and are prolonged when the fibrinogen level is low (usually <80–100 mg/dL); qualitatively abnormal, as seen in inherited or acquired dysfibrinogenemias; or when fibrin/fibrinogen degradation products interfere. The thrombin time, but not the reptilase time, is prolonged in the presence of heparin. Measurement of anti-factor Xa plasma inhibitory activity is a test frequently used to assess low-molecular-weight heparin (LMWH) activity or as a direct measurement of unfractionated heparin (UFH) activity. Heparin in the patient sample inhibits the enzymatic conversion of an Xa-specific chromogenic substrate to colored product by factor Xa. Standard curves are created using multiple concentrations of UFH and LMWH and used to calculate the concentration of anti-Xa activity in the patient plasma.

**Laboratory Testing for Thrombophilia** Laboratory assays to detect thrombophilic states include molecular diagnostic, immunologic, and functional assays. These assays vary in their sensitivity and specificity for the condition being tested. Furthermore, acute thrombosis, acute illnesses, inflammatory conditions, pregnancy, and medications affect levels of many coagulation factors and their inhibitors. Antithrombin is decreased by heparin and in the setting of acute thrombosis. Protein C and S levels may be increased in the setting of acute thrombosis and are decreased by warfarin. Antiphospholipid antibodies are frequently transiently positive in acute illness. Because thrombophilia evaluations are usually performed to assess the need to extend anticoagulation, testing should be performed in a steady state, remote from the acute event. In most instances warfarin anticoagulation can be stopped after the initial 3–6 months of treatment, and testing is performed at least 3 weeks later. Furthermore, sensitive markers of coagulation activation, notably the D-dimer assay and the thrombin generation test, hold promise as predictors, when elevated, of recurrent thrombosis when measured at least 1 month from discontinuation of warfarin, although further study is needed to better support this application.

**Measures of Platelet Function** The bleeding time has been used to assess bleeding risk; however, it has not been found to predict bleeding risk with surgery, and it is not recommended for use for this indication. The PFA-100 and similar instruments that measure platelet-dependent coagulation under flow conditions

are generally more sensitive and specific for platelet disorders and vWD than the bleeding time; however, data are insufficient to support their use to predict bleeding risk or monitor response to therapy. When they are used in the evaluation of a patient with bleeding symptoms, abnormal results, as with the bleeding time, require specific testing, such as vWF assays and/or platelet aggregation studies. Because all of these “screening” assays may miss patients with mild bleeding disorders, further studies are needed to define their role in hemostasis testing.

For classic platelet aggregometry, various agonists are added to the patient’s platelet-rich plasma, and platelet agglutination and aggregation are observed. Tests of platelet secretion in response to agonists can also be measured. These tests are affected by many factors, including numerous medications, and the association between minor defects in aggregation or secretion in these assays and bleeding risk is not clearly established.

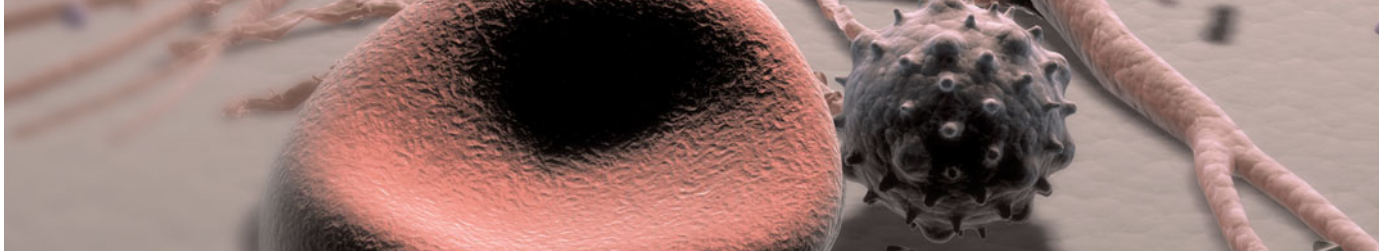
#### ACKNOWLEDGMENT

*Robert I. Handin, MD, contributed this chapter in the 16th edition of Harrison’s Principles of Internal Medicine, and some material from that chapter have been retained here.*

#### FURTHER READINGS

- BAUER KA: Management of thrombophilia. *J Thromb Haemost* 1:1429, 2003
- BOCKENSTEDT PL: Laboratory methods in hemostasis, in *Thrombosis and Hemorrhage*, 3d ed, J Loscalzo, AI Schafer (eds). Philadelphia, Lippincott Williams & Wilkins, 2003, pp 363–423
- COLMAN RW et al: Overview of hemostasis, in *Hemostasis and Thrombosis*, 5th ed, RW Colman et al (eds). Philadelphia, Lippincott Williams & Wilkins, 2006, pp 3–16
- DELOUGHERY TG: Venous thrombotic emergencies. *Emerg Med Clin North Am* 27:445, 2009
- FRANCHINI M et al: Thyroid dysfunction and hemostasis: An issue still unresolved. *Semin Thromb Hemost* 35:288, 2009
- HEIT JA: The epidemiology of venous thromboembolism in the community: Implications for prevention and management. *J Thromb Thrombol* 21:23, 2006
- KONKLE BA: Clinical approach to the bleeding patient, in *Hemostasis and Thrombosis*, 5th ed, RW Colman et al (eds). Philadelphia, Lippincott Williams & Wilkins, 2006, pp 1147–1158
- LOPEZ JA, CHEN J: Pathophysiology of venous thrombosis. *Thromb Res* 123(Suppl 4):S30, 2009
- MORENO PR et al: Promoting mechanisms of vascular health: Circulating progenitor cells, angiogenesis, and reverse cholesterol transport. *J Am Coll Cardiol* 53:2315, 2009
- ORTEL TL: The antiphospholipid syndrome: What are we really measuring? How do we measure it? And how do we treat it? *J Thromb Thrombol* 21:79, 2006
- ROBERTS HR et al: A cell-based model of thrombin generation. *Semin Thromb Hemost* 32(Suppl 1):32, 2006





## CHAPTER 4

# ENLARGEMENT OF LYMPH NODES AND SPLEEN

Patrick H. Henry ■ Dan L. Longo

■ Lymphadenopathy . . . . .	32
■ Splenomegaly . . . . .	35
Structure and Function of the Spleen . . . . .	35
Splenectomy . . . . .	38
■ Further Readings . . . . .	41

This chapter is intended to serve as a guide to the evaluation of patients who present with enlargement of the lymph nodes (*lymphadenopathy*) or the spleen (*splenomegaly*). Lymphadenopathy is a rather common clinical finding in primary care settings, whereas palpable splenomegaly is less so.

### LYMPHADENOPATHY

Lymphadenopathy may be an incidental finding in patients being examined for various reasons, or it may be a presenting sign or symptom of the patient's illness. The physician must eventually decide whether the lymphadenopathy is a normal finding or one that requires further study, up to and including biopsy. Soft, flat, submandibular nodes (<1 cm) are often palpable in healthy children and young adults, and healthy adults may have palpable inguinal nodes of up to 2 cm, which are considered normal. Further evaluation of these normal nodes is not warranted. In contrast, if the physician believes the node(s) to be abnormal, then pursuit of a more precise diagnosis is needed.

#### Approach to the Patient: LYMPHADENOPATHY

Lymphadenopathy may be a primary or secondary manifestation of numerous disorders, as shown in

**Table 4-1.** Many of these disorders are infrequent causes of lymphadenopathy. In primary care practice, more than two-thirds of patients with lymphadenopathy have nonspecific causes or upper respiratory illnesses (viral or bacterial), and <1% have a malignancy. In one study, 84% of patients referred for evaluation of lymphadenopathy had a “benign” diagnosis. The remaining 16% had a malignancy (lymphoma or metastatic adenocarcinoma). Of the patients with benign lymphadenopathy, 63% had a nonspecific or reactive etiology (no causative agent found), and the remainder had a specific cause demonstrated, most commonly infectious mononucleosis, toxoplasmosis, or tuberculosis. Thus the vast majority of patients with lymphadenopathy have a nonspecific etiology requiring few diagnostic tests.

**CLINICAL ASSESSMENT** The physician will be aided in the pursuit of an explanation for the lymphadenopathy by a careful medical history, physical examination, selected laboratory tests, and perhaps an excisional lymph node biopsy.

The *medical history* should reveal the setting in which lymphadenopathy is occurring. Symptoms such as sore throat, cough, fever, night sweats, fatigue, weight loss, or pain in the nodes should be sought. The patient's age, sex, occupation, exposure to pets, sexual behavior, and use of drugs such as diphenylhydantoin are other important historic points. For example, children and

TABLE 4-1

## DISEASES ASSOCIATED WITH LYMPHADENOPATHY

1. Infectious diseases
  - a. Viral—*infectious mononucleosis syndromes* (EBV, CMV), *infectious hepatitis*, *herpes simplex*, *herpesvirus-6*, *varicella-zoster virus*, *rubella*, *measles*, *adenovirus*, *HIV*, *epidemic keratoconjunctivitis*, *vaccinia*, *herpesvirus-8*
  - b. Bacterial—*streptococci*, *staphylococci*, *cat-scratch disease*, *brucellosis*, *tularemia*, *plague*, *chancroid*, *melioidosis*, *glanders*, *tuberculosis*, *atypical mycobacterial infection*, *primary and secondary syphilis*, *diphtheria*, *leprosy*
  - c. Fungal—*histoplasmosis*, *coccidioidomycosis*, *paracoccidioidomycosis*
  - d. Chlamydial—*lymphogranuloma venereum*, *trachoma*
  - e. Parasitic—*toxoplasmosis*, *leishmaniasis*, *trypanosomiasis*, *filariasis*
  - f. Rickettsial—*scrub typhus*, *rickettsialpox*, *Q fever*
2. Immunologic diseases
  - a. Rheumatoid arthritis
  - b. Juvenile rheumatoid arthritis
  - c. Mixed connective tissue disease
  - d. Systemic lupus erythematosus
  - e. Dermatomyositis
  - f. Sjögren's syndrome
  - g. Serum sickness
  - h. Drug hypersensitivity—*diphenylhydantoin*, *hydralazine*, *allopurinol*, *primidone*, *gold*, *carbamazepine*, etc.
  - i. *Angioimmunoblastic lymphadenopathy*
  - j. *Primary biliary cirrhosis*
  - k. *Graft-versus-host disease*
  - l. *Silicone-associated*
  - m. *Autoimmune lymphoproliferative syndrome*
3. Malignant diseases
  - a. Hematologic—*Hodgkin's disease*, *non-Hodgkin's lymphomas*, *acute or chronic lymphocytic leukemia*, *hairy cell leukemia*, *malignant histiocytosis*, *amyloidosis*
  - b. Metastatic—from numerous primary sites
4. Lipid storage diseases—*Gaucher's*, *Niemann-Pick*, *Fabry*, *Tangier*
5. Endocrine diseases—*hyperthyroidism*
6. Other disorders
  - a. *Castleman's disease* (*giant lymph node hyperplasia*)
  - b. *Sarcoidosis*
  - c. *Dermatopathic lymphadenitis*
  - d. *Lymphomatoid granulomatosis*
  - e. *Histiocytic necrotizing lymphadenitis* (*Kikuchi's disease*)
  - f. *Sinus histiocytosis with massive lymphadenopathy* (*Rosai-Dorfman disease*)
  - g. *Mucocutaneous lymph node syndrome* (*Kawasaki's disease*)
  - h. *Histiocytosis X*
    - i. *Familial Mediterranean fever*
    - j. *Severe hypertriglyceridemia*
    - k. *Vascular transformation of sinuses*
    - l. *Inflammatory pseudotumor of lymph node*
    - m. *Congestive heart failure*

**Note:** EBV, Epstein-Barr virus; CMV, cytomegalovirus.

young adults usually have benign (i.e., nonmalignant) disorders, such as viral or bacterial upper respiratory infections, infectious mononucleosis, toxoplasmosis, and, in some countries, tuberculosis, which account for the observed lymphadenopathy. In contrast, after age 50 the incidence of malignant disorders increases and that of benign disorders decreases.

The *physical examination* can provide useful clues such as the extent of lymphadenopathy (localized or generalized), size of nodes, texture, presence or absence of nodal tenderness, signs of inflammation over the node, skin lesions, and splenomegaly. A thorough ear, nose, and throat (ENT) examination is indicated in adult patients with cervical adenopathy and a history of tobacco use. Localized or regional adenopathy implies involvement of a single anatomic area. Generalized adenopathy has been defined as involvement of three or more noncontiguous lymph node areas. Many of the causes of lymphadenopathy (Table 4-1) can produce localized or generalized adenopathy, so this distinction is of limited utility in the differential diagnosis. Nevertheless, generalized lymphadenopathy is frequently associated with nonmalignant disorders such as infectious mononucleosis [Epstein-Barr virus (EBV) or cytomegalovirus (CMV)], toxoplasmosis, AIDS, other viral infections, systemic lupus erythematosus (SLE), and mixed connective tissue disease. Acute and chronic lymphocytic leukemias and malignant lymphomas also produce generalized adenopathy in adults.

The site of localized or regional adenopathy may provide a useful clue about the cause. Occipital adenopathy often reflects an infection of the scalp, and preauricular adenopathy accompanies conjunctival infections and cat-scratch disease. The most frequent site of regional adenopathy is the neck, and most of the causes are benign—upper respiratory infections, oral and dental lesions, infectious mononucleosis, other viral illnesses. The chief malignant causes include metastatic cancer from head and neck, breast, lung, and thyroid primaries. Enlargement of supraclavicular and scalene nodes is always abnormal. Because these nodes drain regions of the lung and retroperitoneal space, they can reflect lymphomas, other cancers, or infectious processes arising in these areas. Virchow's node is an enlarged left supraclavicular node infiltrated with metastatic cancer from a gastrointestinal primary. Metastases to supraclavicular nodes also occur from lung, breast, testis, or ovarian cancers. Tuberculosis, sarcoidosis, and toxoplasmosis are nonneoplastic causes of supraclavicular adenopathy. Axillary adenopathy is usually due to injuries or localized infections of the ipsilateral upper extremity. Malignant causes include melanoma or lymphoma and, in women, breast cancer. Inguinal lymphadenopathy

is usually secondary to infections or trauma of the lower extremities and may accompany sexually transmitted diseases such as lymphogranuloma venereum, primary syphilis, genital herpes, or chancroid. These nodes may also be involved by lymphomas and metastatic cancer from primary lesions of the rectum, genitalia, or lower extremities (melanoma).

The size and texture of the lymph node(s) and the presence of pain are useful parameters in evaluating a patient with lymphadenopathy. Nodes  $<1.0 \text{ cm}^2$  in area ( $1.0 \text{ cm} \times 1.0 \text{ cm}$  or less) are almost always secondary to benign, nonspecific reactive causes. In one retrospective analysis of younger patients (9–25 years) who had a lymph node biopsy, a maximum diameter of  $>2 \text{ cm}$  served as one discriminant for predicting that the biopsy would reveal malignant or granulomatous disease. Another study showed that a lymph node size of  $2.25 \text{ cm}^2$  ( $1.5 \text{ cm} \times 1.5 \text{ cm}$ ) was the best size limit for distinguishing malignant or granulomatous lymphadenopathy from other causes of lymphadenopathy. Patients with node(s)  $\leq 1.0 \text{ cm}^2$  should be observed after excluding infectious mononucleosis and/or toxoplasmosis unless there are symptoms and signs of an underlying systemic illness.

The texture of lymph nodes may be described as soft, firm, rubbery, hard, discrete, matted, tender, movable, or fixed. Tenderness is found when the capsule is stretched during rapid enlargement, usually secondary to an inflammatory process. Some malignant diseases such as acute leukemia may produce rapid enlargement and pain in the nodes. Nodes involved by lymphoma tend to be large, discrete, symmetric, rubbery, firm, mobile, and nontender. Nodes containing metastatic cancer are often hard, nontender, and nonmovable because of fixation to surrounding tissues. The coexistence of splenomegaly in the patient with lymphadenopathy implies a systemic illness such as infectious mononucleosis, lymphoma, acute or chronic leukemia, SLE, sarcoidosis, toxoplasmosis, cat-scratch disease, or other less common hematologic disorders. The patient's story should provide helpful clues about the underlying systemic illness.

Nonsuperficial presentations (thoracic or abdominal) of adenopathy are usually detected as the result of a symptom-directed diagnostic workup. Thoracic adenopathy may be detected by routine chest radiography or during the workup for superficial adenopathy. It may also be found because the patient complains of a cough or wheezing from airway compression; hoarseness from recurrent laryngeal nerve involvement; dysphagia from esophageal compression; or swelling of the neck, face, or arms secondary to compression of the superior vena cava or subclavian vein. The differential diagnosis of mediastinal and hilar adenopathy includes primary lung

disorders and systemic illnesses that characteristically involve mediastinal or hilar nodes. In the young, mediastinal adenopathy is associated with infectious mononucleosis and sarcoidosis. In endemic regions, histoplasmosis can cause unilateral paratracheal lymph node involvement that mimics lymphoma. Tuberculosis can also cause unilateral adenopathy. In older patients, the differential diagnosis includes primary lung cancer (especially among smokers), lymphomas, metastatic carcinoma (usually lung), tuberculosis, fungal infection, and sarcoidosis.

Enlarged intra-abdominal or retroperitoneal nodes are usually malignant. Although tuberculosis may present as mesenteric lymphadenitis, these masses usually contain lymphomas or, in young men, germ cell tumors.

**LABORATORY INVESTIGATION** The laboratory investigation of patients with lymphadenopathy must be tailored to elucidate the etiology suspected from the patient's history and physical findings. One study from a family practice clinic evaluated 249 younger patients with "enlarged lymph nodes, not infected" or "lymphadenitis." No laboratory studies were obtained in 51%. When studies were performed, the most common were a complete blood count (CBC) (33%), throat culture (16%), chest x-ray (12%), or monospot test (10%). Only eight patients (3%) had a node biopsy, and half of those were normal or reactive. The CBC can provide useful data for the diagnosis of acute or chronic leukemias, EBV or CMV mononucleosis, lymphoma with a leukemic component, pyogenic infections, or immune cytopenias in illnesses such as SLE. Serologic studies may demonstrate antibodies specific to components of EBV, CMV, HIV, and other viruses; *Toxoplasma gondii*; *Bruceella*; etc. If SLE is suspected, then antinuclear and anti-DNA antibody studies are warranted.

The chest x-ray is usually negative, but the presence of a pulmonary infiltrate or mediastinal lymphadenopathy would suggest tuberculosis, histoplasmosis, sarcoidosis, lymphoma, primary lung cancer, or metastatic cancer and demands further investigation.

A variety of imaging techniques (CT, MRI, ultrasound, color Doppler ultrasonography) have been employed to differentiate benign from malignant lymph nodes, especially in patients with head and neck cancer. CT and MRI are comparably accurate (65–90%) in the diagnosis of metastases to cervical lymph nodes. Ultrasonography has been used to determine the long (L) axis, short (S) axis, and a ratio of long to short axis in cervical nodes. An L/S ratio of  $<2.0$  has a sensitivity and a specificity of 95% for distinguishing benign and malignant nodes in patients

with head and neck cancer. This ratio has greater specificity and sensitivity than palpation or measurement of either the long or the short axis alone.

The indications for lymph node biopsy are imprecise, yet it is a valuable diagnostic tool. The decision to biopsy may be made early in a patient's evaluation or delayed for up to 2 weeks. Prompt biopsy should occur if the patient's history and physical findings suggest a malignancy; examples include a solitary, hard, nontender cervical node in an older patient who is a chronic user of tobacco; supraclavicular adenopathy; and solitary or generalized adenopathy that is firm, movable, and suggestive of lymphoma. If a primary head and neck cancer is suspected as the basis of a solitary, hard cervical node, then a careful ENT examination should be performed. Any mucosal lesion that is suspicious for a primary neoplastic process should be biopsied first. If no mucosal lesion is detected, an excisional biopsy of the largest node should be performed. Fine-needle aspiration should not be performed as the first diagnostic procedure. Most diagnoses require more tissue than such aspiration can provide, and it often delays a definitive diagnosis. Fine-needle aspiration should be reserved for thyroid nodules and for confirmation of relapse in patients whose primary diagnosis is known. If the primary physician is uncertain about whether to proceed to biopsy, consultation with a hematologist or medical oncologist should be helpful. In primary care practices, <5% of lymphadenopathy patients require a biopsy. That percentage is considerably larger in referral practices, i.e., hematology, oncology, or ENT.

Two groups have reported algorithms that they claim will identify more precisely those lymphadenopathy patients who should have a biopsy. Both reports were retrospective analyses in referral practices. The first study involved patients 9–25 years of age who had a node biopsy performed. Three variables were identified that predicted those young patients with peripheral lymphadenopathy who should undergo biopsy; lymph node size >2 cm in diameter and abnormal chest x-ray had positive predictive values, whereas recent ENT symptoms had negative predictive values. The second study evaluated 220 lymphadenopathy patients in a hematology unit and identified five variables [lymph node size, location (supraclavicular or nonsupraclavicular), age (>40 years or <40 years), texture (nonhard or hard), and tenderness] that were used in a mathematical model to identify those patients requiring a biopsy. Positive predictive value was found for age >40 years, supraclavicular location, node size >2.25 cm<sup>2</sup>, hard texture, and lack of pain or tenderness. Negative predictive value was evident for age <40 years, node size

<1.0 cm<sup>2</sup>, nonhard texture, and tender or painful nodes. Ninety-one percent of those who required biopsy were correctly classified by this model. Because both of these studies were retrospective analyses and one was limited to young patients, it is not known how useful these models would be if applied prospectively in a primary care setting.

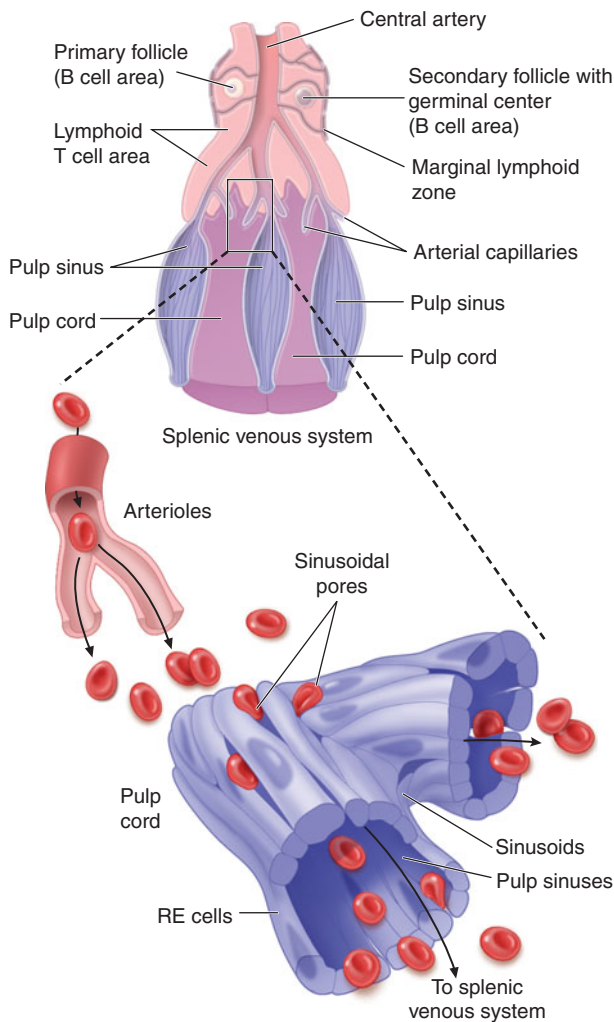
Most lymphadenopathy patients do not require a biopsy, and at least half require no laboratory studies. If the patient's history and physical findings point to a benign cause for lymphadenopathy, then careful follow-up at a 2- to 4-week interval can be employed. The patient should be instructed to return for reevaluation if the node(s) increase in size. Antibiotics are not indicated for lymphadenopathy unless strong evidence of a bacterial infection is present. Glucocorticoids should not be used to treat lymphadenopathy because their lympholytic effect obscures some diagnoses (lymphoma, leukemia, Castleman's disease) and they contribute to delayed healing or activation of underlying infections. An exception to this statement is the life-threatening pharyngeal obstruction by enlarged lymphoid tissue in Waldeyer's ring that is occasionally seen in infectious mononucleosis.

## SPLENOMEGALY

### STRUCTURE AND FUNCTION OF THE SPLEEN

The spleen is a reticuloendothelial organ that has its embryologic origin in the dorsal mesogastrum at ~5 weeks' gestation. It arises in a series of hillocks, migrates to its normal adult location in the left upper quadrant (LUQ), and is attached to the stomach via the gastrosplenic ligament and to the kidney via the lienorenal ligament. When the hillocks fail to unify into a single tissue mass, accessory spleens may develop in ~20% of persons. The function of the spleen has been elusive. Galen believed it was the source of "black bile" or melancholia, and the word *hypochondria* (literally, "beneath the ribs") and the idiom "to vent one's spleen" attest to the beliefs that the spleen has an important influence on the psyche and emotions. In humans its normal physiologic roles seem to be the following:

1. Maintenance of quality control over erythrocytes in the red pulp by removal of senescent and defective red blood cells. The spleen accomplishes this function through a unique organization of its parenchyma and vasculature (Fig. 4-1).
2. Synthesis of antibodies in the white pulp.
3. The removal of antibody-coated bacteria and antibody-coated blood cells from the circulation.

**FIGURE 4-1**

**Schematic spleen structure.** The spleen comprises many units of red and white pulp centered around small branches of the splenic artery, called *central arteries*. White pulp is lymphoid in nature and contains B cell follicles, a marginal zone around the follicles, and T cell-rich areas sheathing arterioles. The red pulp areas include pulp sinuses and pulp cords. The cords are dead ends. To regain access to the circulation, red blood cells must traverse tiny openings in the sinusoidal lining. Stiff, damaged, or old red cells cannot enter the sinuses. (Top portion of figure from CA Janeway et al: *Immunobiology*, 5th ed., New York, Garland, 2001; bottom portion of figure from RS Hillman, KA Ault: *Hematology in Clinical Practice*, 4th ed. New York, McGraw-Hill, 2005.)

An increase in these normal functions may result in splenomegaly.

The spleen is composed of *red pulp* and *white pulp*, which are Malpighi's terms for the red blood-filled sinuses and reticuloendothelial cell-lined cords and the white lymphoid follicles arrayed within the red pulp matrix. The spleen is in the portal circulation. The reason for this is unknown but may relate to the fact that lower blood pressure allows less rapid flow and minimizes

damage to normal erythrocytes. Blood flows into the spleen at a rate of ~150 mL/minute through the splenic artery, which ultimately ramifies into central arterioles. Some blood goes from the arterioles to capillaries and then to splenic veins and out of the spleen, but most of the blood from central arterioles flows into the macrophage-lined sinuses and cords. The blood entering the sinuses reenters the circulation through the splenic venules, but the blood entering the cords is subjected to an inspection of sorts. To return to the circulation, the blood cells in the cords must squeeze through slits in the cord lining to enter the sinuses that lead to the venules. Old and damaged erythrocytes are less deformable and are retained in the cords, where they are destroyed and their components recycled. Red cell inclusion bodies such as parasites, nuclear residua (Howell-Jolly bodies, Fig. 2-6), or denatured hemoglobin (Heinz bodies) are pinched off in the process of passing through the slits, a process called *pitting*. The culling of dead and damaged cells and the pitting of cells with inclusions appear to occur without significant delay because the blood transit time through the spleen is only slightly slower than in other organs.

The spleen is also capable of assisting the host in adapting to its hostile environment. It has at least three adaptive functions: (1) clearance of bacteria and particulates from the blood, (2) the generation of immune responses to certain pathogens, and (3) the generation of cellular components of the blood under circumstances in which the marrow is unable to meet the needs (i.e., extramedullary hematopoiesis). The latter adaptation is a recapitulation of the blood-forming function the spleen plays during gestation. In some animals, the spleen also serves a role in the vascular adaptation to stress because it stores red blood cells (often hemoconcentrated to higher hematocrits than normal) under normal circumstances and contracts under the influence of  $\beta$ -adrenergic stimulation to provide the animal with an autotransfusion and improved oxygen-carrying capacity. However, the normal human spleen does not sequester or store red blood cells and does not contract in response to sympathetic stimuli. The normal human spleen contains approximately a third of the total body platelets and a significant number of marginated neutrophils. These sequestered cells are available when needed to respond to bleeding or infection.

### Approach to the Patient:

#### SPLENOMEGALY

**CLINICAL ASSESSMENT** The most common *symptoms* produced by diseases involving the spleen are pain and a heavy sensation in the LUQ. Massive splenomegaly may cause early satiety. Pain may result from acute swelling of the spleen with stretching of the capsule,

infarction, or inflammation of the capsule. For many years it was believed that splenic infarction was clinically silent, which at times is true. However, Soma Weiss, in his classic 1942 report of the self-observations by a Harvard medical student on the clinical course of subacute bacterial endocarditis, documented that severe LUQ and pleuritic chest pain may accompany thromboembolic occlusion of splenic blood flow. Vascular occlusion, with infarction and pain, is commonly seen in children with sickle cell crises. Rupture of the spleen, from either trauma or infiltrative disease that breaks the capsule, may result in intraperitoneal bleeding, shock, and death. The rupture itself may be painless.

A palpable spleen is the major *physical sign* produced by diseases affecting the spleen and suggests enlargement of the organ. The normal spleen is said to weigh <250 g, decreases in size with age, normally lies entirely within the rib cage, has a maximum cephalocaudad diameter of 13 cm by ultrasonography or maximum length of 12 cm and/or width of 7 cm by radionuclide scan, and is usually not palpable. However, a palpable spleen was found in 3% of 2200 asymptomatic male first-year college students. Follow-up at 3 years revealed that 30% of those students still had a palpable spleen without any increase in disease prevalence. Ten-year follow-up found no evidence for lymphoid malignancies. Furthermore, in some tropical countries (e.g., New Guinea) the incidence of splenomegaly may reach 60%. Thus the presence of a palpable spleen does not always equate with presence of disease. Even when disease is present, splenomegaly may not reflect the primary disease but rather a reaction to it. For example, in patients with Hodgkin's disease, only two-thirds of the palpable spleens show involvement by the cancer.

Physical examination of the spleen uses primarily the techniques of palpation and percussion. Inspection may reveal fullness in the LUQ that descends on inspiration, a finding associated with a massively enlarged spleen. Auscultation may reveal a venous hum or friction rub.

*Palpation* can be accomplished by bimanual palpation, ballottement, and palpation from above (Middleton maneuver). For bimanual palpation, which is at least as reliable as the other techniques, the patient is supine with flexed knees. The examiner's left hand is placed on the lower rib cage and pulls the skin toward the costal margin, allowing the fingertips of the right hand to feel the tip of the spleen as it descends while the patient inspires slowly, smoothly, and deeply. Palpation is begun with the right hand in the left lower quadrant with gradual movement toward the left costal margin, thereby identifying the lower edge of a massively enlarged spleen. When the

spleen tip is felt, the finding is recorded as centimeters below the left costal margin at some arbitrary point, i.e., 10–15 cm, from the midpoint of the umbilicus or the xiphisternal junction. This allows other examiners to compare findings or the initial examiner to determine changes in size over time. Bimanual palpation in the right lateral decubitus position adds nothing to the supine examination.

*Percussion* for splenic dullness is accomplished with any of three techniques described by Nixon, Castell, or Barkun:

1. *Nixon's method*: The patient is placed on the right side so that the spleen lies above the colon and stomach. Percussion begins at the lower level of pulmonary resonance in the posterior axillary line and proceeds diagonally along a perpendicular line toward the lower midanterior costal margin. The upper border of dullness is normally 6–8 cm above the costal margin. Dullness >8 cm in an adult is presumed to indicate splenic enlargement.
2. *Castell's method*: With the patient supine, percussion in the lowest intercostal space in the anterior axillary line (8th or 9th) produces a resonant note if the spleen is normal in size. This is true during expiration or full inspiration. A dull percussion note on full inspiration suggests splenomegaly.
3. *Percussion of Traube's semilunar space*: The borders of Traube's space are the sixth rib superiorly, the left midaxillary line laterally, and the left costal margin inferiorly. The patient is supine with the left arm slightly abducted. During normal breathing, this space is percussed from medial to lateral margins, yielding a normal resonant sound. A dull percussion note suggests splenomegaly.

Studies comparing methods of percussion and palpation with a standard of ultrasonography or scintigraphy have revealed sensitivity of 56–71% for palpation and 59–82% for percussion. Reproducibility among examiners is better for palpation than percussion. Both techniques are less reliable in obese patients or patients who have just eaten. Thus the physical examination techniques of palpation and percussion are imprecise at best. It has been suggested that the examiner perform percussion first and, if positive, proceed to palpation; if the spleen is palpable, then one can be reasonably confident that splenomegaly exists. However, not all LUQ masses are enlarged spleens; gastric or colon tumors and pancreatic or renal cysts or tumors can mimic splenomegaly.

The presence of an enlarged spleen can be more precisely determined, if necessary, by liver-spleen radionuclide scan, CT, MRI, or ultrasonography. The latter technique is the current procedure of choice

for routine assessment of spleen size (normal = a maximum cephalocaudal diameter of 13 cm) because it has high sensitivity and specificity and is safe, non-invasive, quick, mobile, and less costly. Nuclear medicine scans are accurate, sensitive, and reliable but are costly, require greater time to generate data, and use immobile equipment. They have the advantage of demonstrating accessory splenic tissue. CT and MRI provide accurate determination of spleen size, but the equipment is immobile and the procedures are expensive. MRI appears to offer no advantage over CT. Changes in spleen structure such as mass lesions, infarcts, inhomogeneous infiltrates, and cysts are more readily assessed by CT, MRI, or ultrasonography. None of these techniques is very reliable in the detection of patchy infiltration (e.g., Hodgkin's disease).

**DIFFERENTIAL DIAGNOSIS** Many of the diseases associated with splenomegaly are listed in [Table 4-2](#). They are grouped according to the presumed basic mechanisms responsible for organ enlargement:

1. Hyperplasia or hypertrophy related to a particular splenic function such as reticuloendothelial hyperplasia (work hypertrophy) in diseases such as hereditary spherocytosis or thalassemia syndromes that require removal of large numbers of defective red blood cells; immune hyperplasia in response to systemic infection (infectious mononucleosis, subacute bacterial endocarditis) or to immunologic diseases (immune thrombocytopenia, SLE, Felty's syndrome).
2. Passive congestion due to decreased blood flow from the spleen in conditions that produce portal hypertension (cirrhosis, Budd-Chiari syndrome, congestive heart failure).
3. Infiltrative diseases of the spleen (lymphomas, metastatic cancer, amyloidosis, Gaucher's disease, myeloproliferative disorders with extramedullary hematopoiesis).

The differential diagnostic possibilities are much fewer when the spleen is "massively enlarged," palpable >8 cm below the left costal margin or its drained weight is  $\geq 1000$  g ([Table 4-3](#)). The vast majority of such patients will have non-Hodgkin's lymphoma, chronic lymphocytic leukemia, hairy cell leukemia, chronic myelogenous leukemia, myelofibrosis with myeloid metaplasia, or polycythemia vera.

**LABORATORY ASSESSMENT** The major laboratory abnormalities accompanying splenomegaly are determined by the underlying systemic illness. Erythrocyte counts may be normal, decreased (thalassemia major syndromes, SLE, cirrhosis with portal hypertension), or increased (polycythemia vera). Granulocyte counts

may be normal, decreased (Felty's syndrome, congestive splenomegaly, leukemias), or increased (infections or inflammatory disease, myeloproliferative disorders). Similarly, the platelet count may be normal, decreased when there is enhanced sequestration or destruction of platelets in an enlarged spleen (congestive splenomegaly, Gaucher's disease, immune thrombocytopenia), or increased in the myeloproliferative disorders such as polycythemia vera.

The CBC may reveal cytopenia of one or more blood cell types, which should suggest *hypersplenism*. This condition is characterized by splenomegaly, cytopenia(s), normal or hyperplastic bone marrow, and a response to splenectomy. The latter characteristic is less precise because reversal of cytopenia, particularly granulocytopenia, is sometimes not sustained after splenectomy. The cytopenias result from increased destruction of the cellular elements secondary to reduced flow of blood through enlarged and congested cords (congestive splenomegaly) or to immune-mediated mechanisms. In hypersplenism, various cell types usually have normal morphology on the peripheral blood smear, although the red cells may be spherocytic due to loss of surface area during their longer transit through the enlarged spleen. The increased marrow production of red cells should be reflected as an increased reticulocyte production index, although the value may be less than expected due to increased sequestration of reticulocytes in the spleen.

The need for additional laboratory studies is dictated by the differential diagnosis of the underlying illness of which splenomegaly is a manifestation.

## SPLENECTOMY

Splenectomy is infrequently performed for diagnostic purposes, especially in the absence of clinical illness or other diagnostic tests that suggest underlying disease. More often splenectomy is performed for symptom control in patients with massive splenomegaly, for disease control in patients with traumatic splenic rupture, or for correction of cytopenias in patients with hypersplenism or immune-mediated destruction of one or more cellular blood elements. Splenectomy is necessary for staging of patients with Hodgkin's disease only in those with clinical stage I or II disease in whom radiation therapy alone is contemplated as the treatment. Noninvasive staging of the spleen in Hodgkin's disease is not a sufficiently reliable basis for treatment decisions because a third of normal-sized spleens are involved with Hodgkin's disease and a third of enlarged spleens are tumor-free. Although splenectomy in chronic myelogenous leukemia does not affect the natural history of

TABLE 4-2

DISEASES ASSOCIATED WITH SPLENOMEGALY GROUPED BY PATHOGENIC MECHANISM	
<p><b>Enlargement Due to Increased Demand for Splenic Function</b></p> <p><i>Reticuloendothelial system hyperplasia (for removal of defective erythrocytes)</i></p> <ul style="list-style-type: none"> <li>Spherocytosis</li> <li>Early sickle cell anemia</li> <li>Ovalocytosis</li> <li>Thalassemia major</li> <li>Hemoglobinopathies</li> <li>Paroxysmal nocturnal hemoglobinuria</li> <li>Pernicious anemia</li> </ul> <p><i>Immune hyperplasia</i></p> <ul style="list-style-type: none"> <li>Response to infection (viral, bacterial, fungal, parasitic)               <ul style="list-style-type: none"> <li>Infectious mononucleosis</li> <li>AIDS</li> <li>Viral hepatitis</li> <li>Cytomegalovirus</li> <li>Subacute bacterial endocarditis</li> <li>Bacterial septicemia</li> <li>Congenital syphilis</li> <li>Splenic abscess</li> <li>Tuberculosis</li> <li>Histoplasmosis</li> <li>Malaria</li> <li>Leishmaniasis</li> <li>Trypanosomiasis</li> <li>Ehrlichiosis</li> </ul> </li> <li>Disordered immunoregulation               <ul style="list-style-type: none"> <li>Rheumatoid arthritis (Felty's syndrome)</li> <li>Systemic lupus erythematosus</li> <li>Collagen vascular diseases</li> <li>Serum sickness</li> <li>Immune hemolytic anemias</li> <li>Immune thrombocytopenias</li> <li>Immune neutropenias</li> <li>Drug reactions</li> <li>Angioimmunoblastic lymphadenopathy</li> <li>Sarcoidosis</li> <li>Thyrotoxicosis (benign lymphoid hypertrophy)</li> <li>Interleukin 2 therapy</li> </ul> </li> </ul> <p><i>Extramedullary hematopoiesis</i></p> <ul style="list-style-type: none"> <li>Myelofibrosis</li> <li>Marrow damage by toxins, radiation, strontium</li> <li>Marrow infiltration by tumors, leukemias, Gaucher's disease</li> </ul>	<p><b>Enlargement Due to Abnormal Splenic or Portal Blood Flow</b></p> <ul style="list-style-type: none"> <li>Cirrhosis</li> <li>Hepatic vein obstruction</li> <li>Portal vein obstruction, intrahepatic or extrahepatic</li> <li>Cavernous transformation of the portal vein</li> <li>Splenic vein obstruction</li> <li>Splenic artery aneurysm</li> <li>Hepatic schistosomiasis</li> <li>Congestive heart failure</li> <li>Hepatic echinococcosis</li> <li>Portal hypertension (any cause including the above): "Banti's disease"</li> </ul> <p><b>Infiltration of the Spleen</b></p> <p><i>Intracellular or extracellular depositions</i></p> <ul style="list-style-type: none"> <li>Amyloidosis</li> <li>Gaucher's disease</li> <li>Niemann-Pick disease</li> <li>Tangier disease</li> <li>Hurler's syndrome and other mucopolysaccharidoses</li> <li>Hyperlipidemias</li> </ul> <p><i>Benign and malignant cellular infiltrations</i></p> <ul style="list-style-type: none"> <li>Leukemias (acute, chronic, lymphoid, myeloid, monocytic)</li> <li>Lymphomas</li> <li>Hodgkin's disease</li> <li>Myeloproliferative syndromes (e.g., polycythemia vera, essential thrombocytosis)</li> <li>Angiosarcomas</li> <li>Metastatic tumors (melanoma is most common)</li> <li>Eosinophilic granuloma</li> <li>Histiocytosis X</li> <li>Hamartomas</li> <li>Hemangiomas, fibromas, lymphangiomas</li> <li>Splenic cysts</li> </ul> <p><b>Unknown Etiology</b></p> <ul style="list-style-type: none"> <li>Idiopathic splenomegaly</li> <li>Berylliosis</li> <li>Iron-deficiency anemia</li> </ul>

disease, removal of the massive spleen usually makes patients significantly more comfortable and simplifies their management by significantly reducing transfusion requirements. Splenectomy is an effective secondary or tertiary treatment for two chronic B cell leukemias, hairy cell leukemia and prolymphocytic leukemia, and for the very rare splenic mantle cell or marginal zone lymphoma. Splenectomy in these diseases may be associated with significant tumor regression in bone marrow and other sites of disease. Similar regressions of systemic

disease have been noted after splenic irradiation in some types of lymphoid tumors, especially chronic lymphocytic leukemia and prolymphocytic leukemia. This has been termed the *abscopal effect*. Such systemic tumor responses to local therapy directed at the spleen suggest that some hormone or growth factor produced by the spleen may affect tumor cell proliferation, but this conjecture is not yet substantiated. A common therapeutic indication for splenectomy is traumatic or iatrogenic splenic rupture. In a fraction of patients with



TABLE 4-3

**DISEASES ASSOCIATED WITH MASSIVE SPLENOMEGALY<sup>a</sup>**

Chronic myelogenous leukemia	Gaucher's disease
Lymphomas	Chronic lymphocytic leukemia
Hairy cell leukemia	Sarcoidosis
Myelofibrosis with myeloid metaplasia	Autoimmune hemolytic anemia
Polycythemia vera	Diffuse splenic hemangiomas

<sup>a</sup>The spleen extends >8 cm below left costal margin and/or weighs >1000 g.

splenic rupture, peritoneal seeding of splenic fragments can lead to *splenosis*—the presence of multiple rests of spleen tissue not connected to the portal circulation. This ectopic spleen tissue may cause pain or gastrointestinal obstruction, as in endometriosis. A large number of hematologic, immunologic, and congestive causes of splenomegaly can lead to destruction of one or more cellular blood elements. In most such cases, splenectomy can correct the cytopenias, particularly anemia and thrombocytopenia. In a large series of patients seen in two tertiary care centers, the indication for splenectomy was diagnostic in 10% of patients, therapeutic in 44%, staging for Hodgkin's disease in 20%, and incidental to another procedure in 26%. Perhaps the only contraindication to splenectomy is the presence of marrow failure, in which the enlarged spleen is the only source of hematopoietic tissue.

The absence of the spleen has minimal long-term effects on the hematologic profile. In the immediate postsplenectomy period, leukocytosis (up to 25,000/ $\mu$ L) and thrombocytosis (up to  $1 \times 10^6$ / $\mu$ L) may develop, but within 2–3 weeks, blood cell counts and survival of each cell lineage are usually normal. The chronic manifestations of splenectomy are marked variation in size and shape of erythrocytes (anisocytosis, poikilocytosis) and the presence of Howell-Jolly bodies (nuclear remnants), Heinz bodies (denatured hemoglobin), basophilic stippling, and an occasional nucleated erythrocyte in the peripheral blood. When such erythrocyte abnormalities appear in a patient whose spleen has not been removed, one should suspect splenic infiltration by tumor that has interfered with its normal culling and pitting function.

The most serious consequence of splenectomy is increased susceptibility to bacterial infections, particularly those with capsules such as *Streptococcus pneumoniae*, *Haemophilus influenzae*, and some gram-negative enteric organisms. Patients <20 years of age are particularly susceptible to overwhelming sepsis with *S. pneumoniae*, and the overall actuarial risk of sepsis in patients who have

had their spleens removed is ~7% in 10 years. The case-fatality rate for pneumococcal sepsis in splenectomized patients is 50–80%. About 25% of patients without spleens develop a serious infection at some time in their life. The frequency is highest within the first 3 years after splenectomy. About 15% of the infections are polymicrobial, and lung, skin, and blood are the most common sites. No increased risk of viral infection has been noted in patients who have no spleen. The susceptibility to bacterial infections relates to the inability to remove opsonized bacteria from the bloodstream and a defect in making antibodies to T cell-independent antigens such as the polysaccharide components of bacterial capsules. Pneumococcal vaccine (23-valent polysaccharide vaccine) should be administered to all patients 2 weeks before elective splenectomy. The Advisory Committee on Immunization Practices recommends that even splenectomized patients receive pneumococcal vaccine with a repeat vaccination 5 years later. Efficacy has not been proven in this setting, and the recommendation discounts the possibility that administration of the vaccine may actually lower the titer of specific pneumococcal antibodies. A more effective pneumococcal conjugate vaccine that involves T cells in the response is now available (Prevenar, 7-valent). The vaccine to *Neisseria meningitidis* should also be given to patients in whom elective splenectomy is planned. Although efficacy data for *H. influenzae* type b vaccine are not available for older children or adults, it may be given to patients who have had a splenectomy.

Splenectomized patients should be educated to consider any unexplained fever as a medical emergency. Prompt medical attention with evaluation and treatment of suspected bacteremia may be lifesaving. Routine chemoprophylaxis with oral penicillin can result in the emergence of drug-resistant strains and is not recommended.

In addition to an increased susceptibility to bacterial infections, splenectomized patients are also more susceptible to the parasitic disease babesiosis. The splenectomized patient should avoid areas where the parasite *Babesia* is endemic (e.g., Cape Cod, MA).

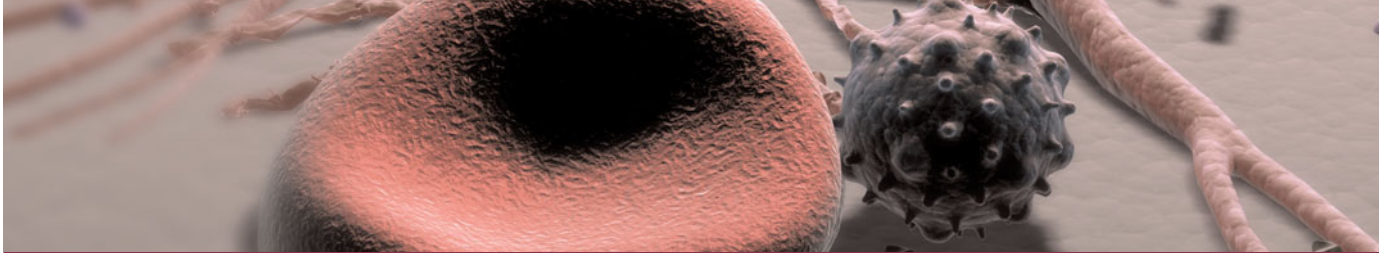
Surgical removal of the spleen is an obvious cause of hyposplenism. Patients with sickle cell disease often suffer from autosplenectomy as a result of splenic destruction by the numerous infarcts associated with sickle cell crises during childhood. Indeed, the presence of a palpable spleen in a patient with sickle cell disease after age 5 suggests a coexisting hemoglobinopathy, e.g., thalassemia or hemoglobin C. In addition, patients who receive splenic irradiation for a neoplastic or autoimmune disease are also functionally hyposplenic. The term *hyposplenism* is preferred to *asplenism* in referring to the physiologic consequences of splenectomy because asplenia is a rare, specific, and fatal congenital abnormality in which there is a failure of the left side of the coelomic

cavity (which includes the splenic anlagen) to develop normally. Infants with asplenia have no spleens, but that is the least of their problems. The right side of the developing embryo is duplicated on the left so there is liver where the spleen should be, there are two right lungs, and the heart comprises two right atria and two right ventricles.

### FURTHER READINGS

- BARKUN AN et al: The bedside assessment of splenic enlargement. *Am J Med* 91:512, 1991
- GARCIA CF, SWERDLOW SH: Best practices in contemporary diagnostic immunohistochemistry: panel approach to hematolymphoid proliferations. *Arch Pathol Lab Med* 133:7556, 2009

- GRAVES SA et al: Does this patient have splenomegaly? *JAMA* 41:270:2218, 1993
- HARNDEN A et al: Kawasaki disease. *BMJ* 338:b1514, 2009
- KRAUS MD et al: The spleen as a diagnostic specimen: A review of ten years' experience at two tertiary care institutions. *Cancer* 91:2001, 2001
- MCINTYRE OR, EBAUGH FG JR: Palpable spleens: Ten year follow-up. *Ann Intern Med* 90:130, 1979
- PANGALIS GA et al: Clinical approach to lymphadenopathy. *Semin Oncol* 20:570, 1993
- POZO AL et al: Splenomegaly: Investigation, diagnosis, and management. *Blood Rev* 23:105, 2009
- Recommended Adult Immunization Schedule—United States, October 2005–September 2006. *MMWR* 54(40):Q1, 2005
- WILLIAMSON HA JR: Lymphadenopathy in a family practice: A descriptive study of 240 cases. *J Fam Pract* 20:449, 1985



## CHAPTER 5

# DISORDERS OF GRANULOCYTES AND MONOCYTES

Steven M. Holland ■ John I. Gallin

■ Neutrophils . . . . .	42
Maturation . . . . .	42
Marrow Release and Circulating Compartments . . . . .	44
Neutrophil Abnormalities . . . . .	47
■ Mononuclear Phagocytes . . . . .	53
Disorders of the Mononuclear Phagocyte System . . . . .	53
■ Eosinophils . . . . .	54
Eosinophilia . . . . .	54
Eosinopenia . . . . .	55
■ Hyperimmunoglobulin E-Recurrent Infection Syndrome . . . . .	55
■ Laboratory Diagnosis and Management . . . . .	55
■ Further Readings . . . . .	56

Leukocytes, the major cells comprising inflammatory and immune responses, include neutrophils, T and B lymphocytes, natural killer (NK) cells, monocytes, eosinophils, and basophils. These cells have specific functions, such as antibody production by B lymphocytes or destruction of bacteria by neutrophils, but in no single infectious disease is the exact role of the cell types completely established. Thus, whereas neutrophils are classically thought to be critical to host defense against bacteria, they may also play important roles in defense against viral infections.

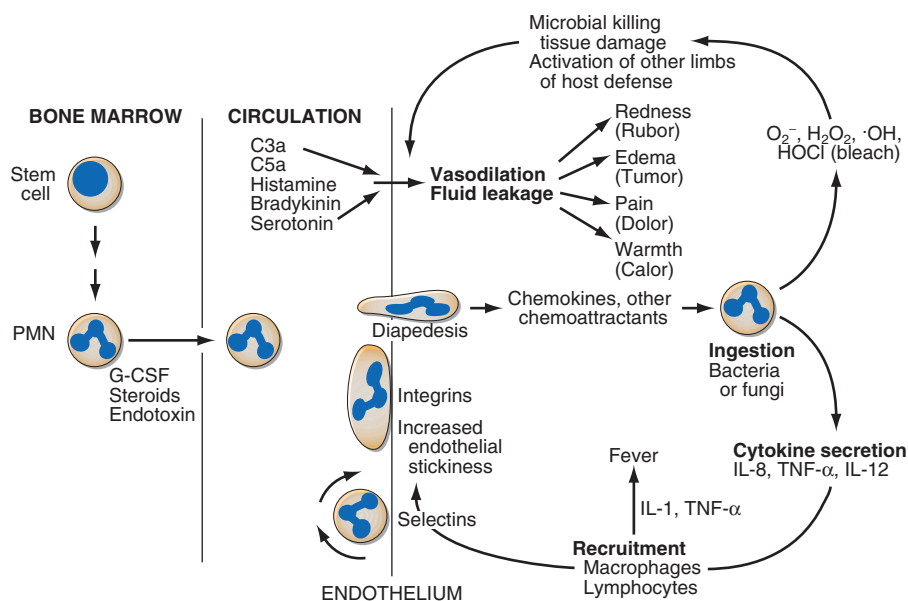
The blood delivers leukocytes to the various tissues from the bone marrow, where they are produced. Normal blood leukocyte counts are  $4.3\text{--}10.8 \times 10^9/\text{L}$ , with neutrophils representing 45–74% of the cells, bands 0–4%, lymphocytes 16–45%, monocytes 4–10%, eosinophils 0–7%, and basophils 0–2%. Variation among individuals and among different ethnic groups can be substantial with lower leukocyte numbers for certain African American ethnic groups. The various leukocytes are derived from a common stem cell in the bone marrow. Three-fourths of the nucleated cells of bone marrow are committed to the production of leukocytes. Leukocyte maturation in the

marrow is under the regulatory control of a number of different factors, known as colony-stimulating factors (CSFs) and interleukins (ILs). Because an alteration in the number and type of leukocytes is often associated with disease processes, total white blood count (WBC) (cells per  $\mu\text{L}$ ) and differential counts are informative. This chapter focuses on neutrophils, monocytes, and eosinophils.

### NEUTROPHILS

#### MATURATION

Important events in neutrophil life are summarized in [Fig. 5–1](#). In normal humans, neutrophils are produced only in the bone marrow. The minimum number of stem cells necessary to support hematopoiesis is estimated to be 400–500 at any one time. Human blood monocytes, tissue macrophages, and stromal cells produce CSFs, hormones required for the growth of monocytes and neutrophils in the bone marrow. The hematopoietic system not only produces enough neutrophils ( $\sim 1.3 \times 10^{11}$  cells per 80-kg person per day) to carry out physiologic

**FIGURE 5-1****Schematic events in neutrophil production, recruitment, and inflammation.**

The four cardinal signs of inflammation (rubor, tumor, calor, dolor) are indicated, as are the interactions of neutrophils with other cells and cytokines. PMN, polymorphonuclear leukocytes; G-CSF, granulocyte colony-stimulating factor; IL, interleukin; TNF- $\alpha$ , tumor necrosis factor  $\alpha$ .

functions but also has a large reserve stored in the marrow, which can be mobilized in response to inflammation or infection. An increase in the number of blood neutrophils is called *neutrophilia*, and the presence of immature cells is termed a *shift to the left*. A decrease in the number of blood neutrophils is called *neutropenia*.

Neutrophils and monocytes evolve from pluripotent stem cells under the influence of cytokines and CSFs (Fig. 5-2). The proliferation phase through the metamyelocyte takes ~1 week; the maturation phase from metamyelocyte to mature neutrophil takes another week. The myeloblast is the first recognizable precursor cell and is followed by the *promyelocyte*. The promyelocyte evolves when the classic lysosomal granules, called the *primary*, or *azurophil*, *granules* are produced. The primary granules contain hydrolases, elastase, myeloperoxidase, cathepsin G, cationic proteins, and bactericidal/permeability-increasing protein, which is important for killing gram-negative bacteria. Azurophil granules also contain *defensins*, a family of cysteine-rich polypeptides with broad antimicrobial activity against bacteria, fungi, and certain enveloped viruses. The promyelocyte divides to produce the *myelocyte*, a cell responsible for the synthesis of the *specific*, or *secondary*, *granules*, which contain unique (specific) constituents such as lactoferrin, vitamin B<sub>12</sub>-binding protein, membrane components of the reduced nicotinamide-adenine dinucleotide phosphate (NADPH) oxidase required for hydrogen peroxide production, histaminase, and receptors for certain chemoattractants and adherence-promoting factors (CR3) as well as receptors for the basement membrane component, laminin. The secondary granules do not contain acid hydrolases and therefore are not classic lysosomes. Packaging of secondary granule contents during myelopoiesis is controlled by CCAAT/enhancer binding protein- $\epsilon$ . Secondary granule contents are readily released extracellularly, and

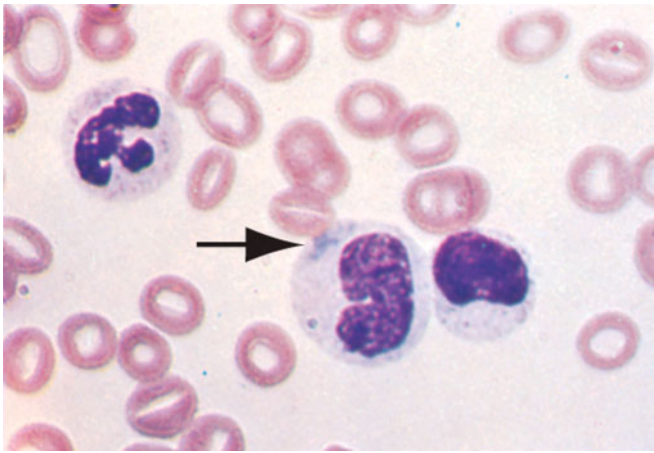
Cell	Stage	Surface Markers <sup>a</sup>	Characteristics
	MYELOBLAST	CD33, CD13, CD15	Prominent nucleoli
	PROMYELOCYTE	CD33, CD13, CD15	Large cell Primary granules appear
	MYELOCYTE	CD33, CD13, CD15, CD14, CD11b	Secondary granules appear
	METAMYELOCYTE	CD33, CD13, CD15, CD14, CD11b	Kidney bean-shaped nucleus
	BAND FORM	CD33, CD13, CD15, CD14, CD11b CD10, CD16	Condensed, band-shaped nucleus
	NEUTROPHIL	CD33, CD13, CD15, CD14, CD11b CD10, CD16	Condensed, multilobed nucleus

<sup>a</sup>CD = Cluster Determinant; ● Nucleolus; ● Primary granule; ● Secondary granule.

**FIGURE 5-2****Stages of neutrophil development shown schematically.**

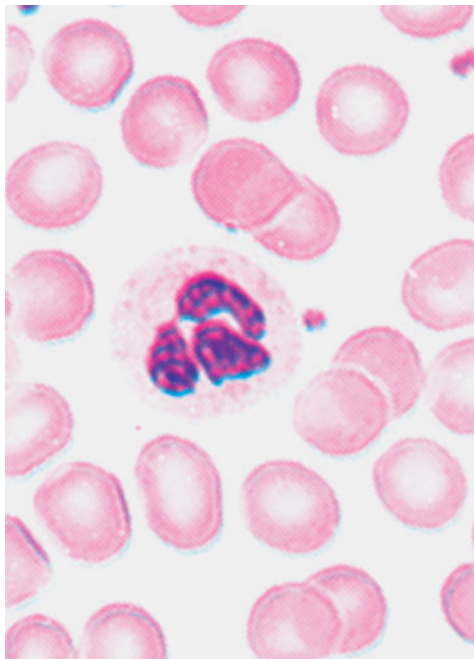
G-CSF (granulocyte colony-stimulating factor) and GM-CSF (granulocyte-macrophage colony-stimulating factor) are critical to this process. Identifying cellular characteristics and specific cell-surface markers are listed for each maturational stage.

their mobilization is important in modulating inflammation. During the final stages of maturation, no cell division occurs, and the cell passes through the metamyelocyte stage and then to the band neutrophil

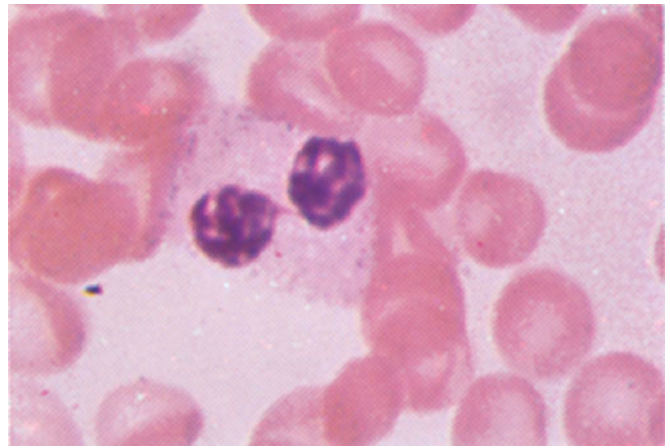
**FIGURE 5-3**

**Neutrophil band with Döhle body.** The neutrophil with a sausage-shaped nucleus in the center of the field is a band form. Döhle bodies are discrete, blue-staining nongranular areas found in the periphery of the cytoplasm of the neutrophil in infections and other toxic states. They represent aggregates of rough endoplasmic reticulum.

with a sausage-shaped nucleus (**Fig. 5-3**). As the band cell matures, the nucleus assumes a lobulated configuration. The nucleus of neutrophils normally contains up to four segments (**Fig. 5-4**). Excessive segmentation (more than five nuclear lobes) may be a manifestation of folate or vitamin B<sub>12</sub> deficiency (see **Fig. 5-4**) and the congenital

**FIGURE 5-4**

**Normal granulocyte.** The normal granulocyte has a segmented nucleus with heavy clumped chromatin; fine neutrophilic granules are dispersed throughout the cytoplasm.

**FIGURE 5-5**

**Pelger-Huet anomaly.** In this benign disorder, the majority of granulocytes are bilobed. The nucleus frequently has a spectacle-like, or "pince-nez," configuration.

neutropenia syndrome of warts, hypogammaglobulinemia, infections, and myelokathexis (WHIM) described later. The Pelger-Huet anomaly (**Fig. 5-5**), an infrequent dominant benign inherited trait, results in neutrophils with distinctive bilobed nuclei that must be distinguished from band forms. Acquired bilobed nuclei, pseudo Pelger-Huet anomaly, can occur with acute infections or in myelodysplastic syndromes. The physiologic role of the normal multilobed nucleus of neutrophils is unknown, but it may allow great deformation of neutrophils during migration into tissues at sites of inflammation.

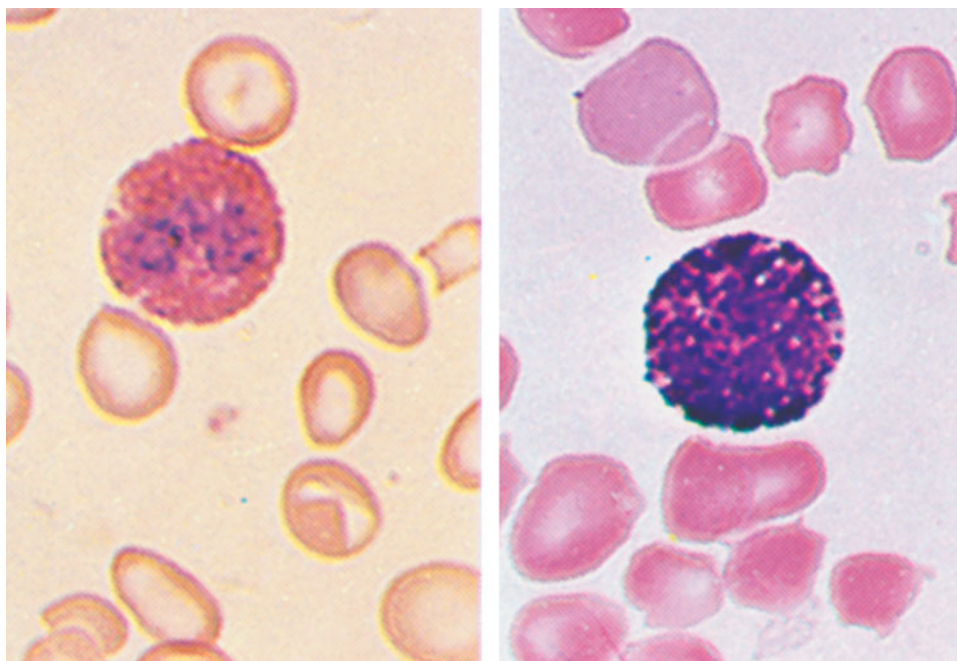
In severe acute bacterial infection, prominent neutrophil cytoplasmic granules, called *toxic granulations*, are occasionally seen. Toxic granulations are immature or abnormally staining azurophil granules. Cytoplasmic inclusions, also called *Döhle bodies* (**Fig. 5-3**), can be seen during infection and are fragments of ribosome-rich endoplasmic reticulum. Large neutrophil vacuoles are often present in acute bacterial infection and probably represent pinocytosed (internalized) membrane.

Neutrophils are heterogeneous in function. Monoclonal antibodies have been developed that recognize only a subset of mature neutrophils. The meaning of neutrophil heterogeneity is not known.

The morphology of eosinophils and basophils is shown in **Fig. 5-6**.

## MARROW RELEASE AND CIRCULATING COMPARTMENTS

Specific signals, including IL-1, tumor necrosis factor  $\alpha$  (TNF- $\alpha$ ), the CSFs, complement fragments, and chemokines, mobilize leukocytes from the bone marrow and deliver them to the blood in an unstimulated state. Under normal conditions, ~90% of the neutrophil

**FIGURE 5-6**

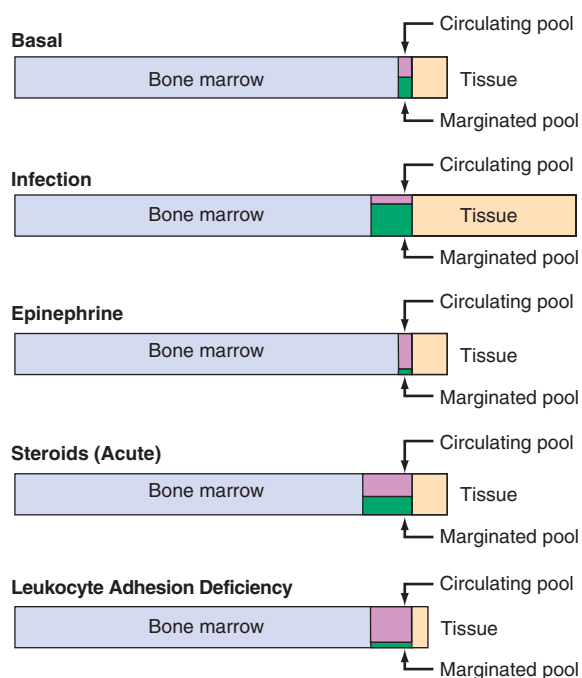
**Normal eosinophil and basophil.** The eosinophil contains large bright orange granules and usually a bilobed nucleus.

The basophil contains large purple-black granules that fill the cell and obscure the nucleus.

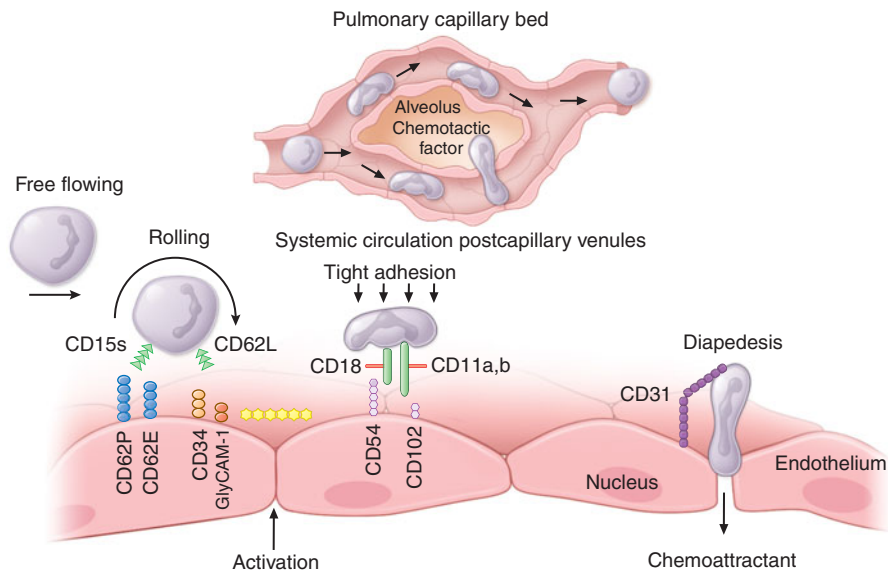
pool is in the bone marrow, 2–3% in the circulation, and the remainder in the tissues (Fig. 5-7).

The circulating pool exists in two dynamic compartments: one freely flowing and one marginated. The freely flowing pool is about half the neutrophils in the

basal state and is composed of those cells that are in the blood and not in contact with the endothelium. Marginated leukocytes are those that are in close physical contact with the endothelium (Fig. 5-8). In the pulmonary circulation, where an extensive capillary bed (~1000 capillaries per alveolus) exists, margination occurs because the capillaries are about the same size as a mature neutrophil. Therefore, neutrophil fluidity and deformability are necessary to make the transit through the pulmonary bed. Increased neutrophil rigidity and decreased deformability lead to augmented neutrophil trapping and margination in the lung. In contrast, in the systemic postcapillary venules, margination is mediated by the interaction of specific cell-surface molecules called *selectins*. Selectins are glycoproteins expressed on neutrophils and endothelial cells, among others, that cause a low-affinity interaction, resulting in “rolling” of the neutrophil along the endothelial surface. On neutrophils, the molecule L-selectin [cluster determinant (CD) 62L] binds to glycosylated proteins on endothelial cells [e.g., glycosylation-dependent cell adhesion molecule (GlyCAM1) and CD34]. Glycoproteins on neutrophils, most importantly sialyl-Lewis<sup>x</sup> (SLe<sup>x</sup>, CD15s), are targets for binding of selectins expressed on endothelial cells [E-selectin (CD62E) and P-selectin (CD62P)] and other leukocytes. In response to chemotactic stimuli from injured tissues (e.g., complement product C5a, leukotriene B<sub>4</sub>, IL-8) or bacterial products [e.g., *N*-formylmethionylleucylphenylalanine (fMet Leu Phe)], neutrophil adhesiveness increases, and the cells

**FIGURE 5-7**

**Schematic neutrophil distribution** and kinetics between the different anatomic and functional pools.

**FIGURE 5-8**

**Neutrophil travel through the pulmonary capillaries is dependent on neutrophil deformability.** Neutrophil rigidity (e.g., caused by C5a) enhances pulmonary trapping and response to pulmonary pathogens in a way that is not so dependent on cell-surface receptors. Intra-alveolar chemotactic factors, such as those caused by certain bacteria (e.g., *Streptococcus pneumoniae*) lead to diapedesis of neutrophils from the pulmonary capillaries into the alveolar space. Neutrophil interaction with the endothelium of the systemic postcapillary venules is dependent on molecules of attachment. The neutrophil “rolls” along the endothelium

using selectins: neutrophil CD15s (sialyl-Lewis<sup>x</sup>) binds to CD62E (E-selectin) and CD62P (P-selectin) on endothelial cells; CD62L (L-selectin) on neutrophils binds to CD34 and other molecules (e.g., GlyCAM-1) expressed on endothelium. Chemokines or other activation factors stimulate integrin-mediated “tight adhesion”: CD11a/CD18 (LFA-1) and CD11b/CD18 (Mac-1, CR3) bind to CD54 (ICAM-1) and CD102 (ICAM-2) on the endothelium. Diapedesis occurs between endothelial cells: CD31 (PECAM-1) expressed by the emigrating neutrophil interacts with CD31 expressed at the endothelial cell-cell junction.

“stick” to the endothelium through *integrins*. The integrins are leukocyte glycoproteins that exist as complexes of a common CD18  $\beta$  chain with CD11a (LFA-1), CD11b (called Mac-1, CR3, or the C3bi receptor), and CD11c (called p150, 95 or CR4). CD11a/CD18 and CD11b/CD18 bind to specific endothelial receptors [intercellular adhesion molecules (ICAM) 1 and 2].

On cell stimulation, L-selectin is shed from neutrophils, and E-selectin increases in the blood, presumably because it is shed from endothelial cells; receptors for chemoattractants and opsonins are mobilized; and the phagocytes orient toward the chemoattractant source in the extravascular space, increase their motile activity (chemokinesis), and migrate directionally (chemotaxis) into tissues. The process of migration into tissues is called *diapedesis* and involves the crawling of neutrophils between postcapillary endothelial cells that open junctions between adjacent cells to permit leukocyte passage. Diapedesis involves platelet/endothelial cell adhesion molecule (PECAM) 1 (CD31), which is expressed on both the emigrating leukocyte and the endothelial cells. The endothelial responses (increased blood flow from increased vasodilation and permeability) are mediated by anaphylatoxins (e.g., C3a and C5a) as well as vasodilators

such as histamine, bradykinin, serotonin, nitric oxide, vascular endothelial growth factor (VEGF), and prostaglandins E and I. Cytokines regulate some of these processes [e.g., TNF- $\alpha$  induction of VEGF, interferon (IFN)  $\gamma$  inhibition of prostaglandin E].

In the healthy adult, most neutrophils leave the body by migration through the mucous membrane of the gastrointestinal tract. Normally, neutrophils spend a short time in the circulation (half-life, 6–7 h). Senescent neutrophils are cleared from the circulation by macrophages in the lung and spleen. Once in the tissues, neutrophils release enzymes, such as collagenase and elastase, which help establish abscess cavities. Neutrophils ingest pathogenic materials that have been opsonized by IgG and C3b. Fibronectin and the tetrapeptide tuftsin also facilitate phagocytosis.

With phagocytosis comes a burst of oxygen consumption and activation of the hexose-monophosphate shunt. A membrane-associated NADPH oxidase, consisting of membrane and cytosolic components, is assembled and catalyzes the reduction of oxygen to superoxide anion, which is then converted to hydrogen peroxide and other toxic oxygen products (e.g., hydroxyl radical). Hydrogen peroxide + chloride + neutrophil

myeloperoxidase generate hypochlorous acid (bleach), hypochlorite, and chlorine. These products oxidize and halogenate microorganisms and tumor cells and, when uncontrolled, can damage host tissue. Strongly cationic proteins, defensins, and probably nitric oxide also participate in microbial killing. Lactoferrin chelates iron, an important growth factor for microorganisms, especially fungi. Other enzymes, such as lysozyme and acid proteases, help digest microbial debris. After 1–4 days in tissues, neutrophils die. The apoptosis of neutrophils is also cytokine-regulated; granulocyte colony-stimulating factor (G-CSF) and IFN- $\gamma$  prolong their life span. Under certain conditions, such as in delayed-type hypersensitivity, monocyte accumulation occurs within 6–12 hours of initiation of inflammation. Neutrophils, monocytes, microorganisms in various states of digestion, and altered local tissue cells make up the inflammatory exudate, pus. Myeloperoxidase confers the characteristic green color to pus and may participate in turning off the inflammatory process by inactivating chemoattractants and immobilizing phagocytic cells.

Neutrophils respond to certain cytokines [IFN- $\gamma$ , granulocyte-macrophage colony-stimulating factor (GM-CSF), IL-8] and produce cytokines and chemotactic signals [TNF- $\alpha$ , IL-8, macrophage inflammatory protein (MIP) 1] that modulate the inflammatory response. In the presence of fibrinogen, fMet Leu Phe or leukotriene B<sub>4</sub> induces IL-8 production by neutrophils, providing autocrine amplification of inflammation. *Chemokines* (chemoattractant cytokines) are small proteins produced by many different cell types, including endothelial cells, fibroblasts, epithelial cells, neutrophils, and monocytes, that regulate neutrophil, monocyte, eosinophil, and lymphocyte recruitment and activation. Chemokines transduce their signals through heterotrimeric G protein-linked receptors that have seven cell membrane-spanning domains, the same type of cell-surface receptor that mediates the response to the classic chemoattractants fMet Leu Phe and C5a. Four major groups of chemokines are recognized based on the cysteine structure near the N terminus: C, CC, CXC, and CXXXC. The CXC cytokines such as IL-8 mainly attract neutrophils; CC chemokines such as MIP-1 attract lymphocytes, monocytes, eosinophils, and basophils; the C chemokine lymphotactin is T cell tropic; the CXXXC chemokine fractalkine attracts neutrophils, monocytes, and T cells. These molecules and their receptors not only regulate the trafficking and activation of inflammatory cells, but specific chemokine receptors serve as co-receptors for HIV infection and have a role in atherogenesis.

## NEUTROPHIL ABNORMALITIES

A defect in the neutrophil life cycle can lead to dysfunction and compromised host defenses. Inflammation is often depressed, and the clinical result is often recurrent

with severe bacterial and fungal infections. Aphthous ulcers of mucous membranes (gray ulcers without pus) and gingivitis and periodontal disease suggest a phagocytic cell disorder. Patients with congenital phagocyte defects can have infections within the first few days of life. Skin, ear, upper and lower respiratory tract, and bone infections are common. Sepsis and meningitis are rare. In some disorders the frequency of infection is variable, and patients can go for months or even years without major infection. Aggressive management of these congenital diseases has extended the life span of patients well beyond 30 years.

## Neutropenia

The consequences of absent neutrophils are dramatic. Susceptibility to infectious diseases increases sharply when neutrophil counts fall below 1000 cells/ $\mu$ L. When the absolute neutrophil count (ANC; band forms and mature neutrophils combined) falls to <500 cells/ $\mu$ L, control of endogenous microbial flora (e.g., mouth, gut) is impaired; when the ANC is <200/ $\mu$ L, the inflammatory process is absent. Neutropenia can be due to depressed production, increased peripheral destruction, or excessive peripheral pooling. A falling neutrophil count or a significant decrease in the number of neutrophils below steady-state levels, together with a failure to increase neutrophil counts in the setting of infection or other challenge, requires investigation. Acute neutropenia, such as that caused by cancer chemotherapy, is more likely to be associated with increased risk of infection than neutropenia of long duration (months to years) that reverses in response to infection or carefully controlled administration of endotoxin (see “Laboratory Diagnosis” later).

Some causes of inherited and acquired neutropenia are listed in [Table 5–1](#). The most common neutropenias are iatrogenic, resulting from the use of cytotoxic or immunosuppressive therapies for malignancy or control of autoimmune disorders. These drugs cause neutropenia because they result in decreased production of rapidly growing progenitor (stem) cells of the marrow. Certain antibiotics such as chloramphenicol, trimethoprim-sulfamethoxazole, flucytosine, vidarabine, and the anti-retroviral drug zidovudine may cause neutropenia by inhibiting proliferation of myeloid precursors. The marrow suppression is generally dose-related and dependent on continued administration of the drug. Recombinant human G-CSF usually reverses this form of neutropenia.

Another important mechanism for iatrogenic neutropenia is the effect of drugs that serve as immune haptens and sensitize neutrophils or neutrophil precursors to immune-mediated peripheral destruction. This form of drug-induced neutropenia can be seen within 7 days of exposure to the drug; with previous drug exposure, resulting in preexisting antibodies, neutropenia may



**CAUSES OF NEUTROPENIA****Decreased production**

Drug-induced—alkylating agents (nitrogen mustard, busulfan, chlorambucil, cyclophosphamide); antimetabolites (methotrexate, 6-mercaptopurine, 5-fluorocytosine); noncytotoxic agents [antibiotics (chloramphenicol, penicillins, sulfonamides), phenothiazines, tranquilizers (meprobamate), anticonvulsants (carbamazepine), antipsychotics (clozapine), certain diuretics, anti-inflammatory agents, antithyroid drugs, many others]

Hematologic diseases—idiopathic, cyclic neutropenia, Chédiak-Higashi syndrome, aplastic anemia, infantile genetic disorders (see text)

Tumor invasion, myelofibrosis

Nutritional deficiency—vitamin B<sub>12</sub>, folate (especially alcoholics)

Infection—tuberculosis, typhoid fever, brucellosis, tularemia, measles, infectious mononucleosis, malaria, viral hepatitis, leishmaniasis, AIDS

**Peripheral destruction**

Antineutrophil antibodies and/or splenic or lung trapping

Autoimmune disorders—Felty's syndrome, rheumatoid arthritis, lupus erythematosus

Drugs as haptens—aminopyrine,  $\alpha$ -methyl dopa, phenylbutazone, mercurial diuretics, some phenothiazines

Wegener's granulomatosis

**Peripheral pooling (transient neutropenia)**

Overwhelming bacterial infection (acute endotoxemia)

Hemodialysis

Cardiopulmonary bypass

(LGLs), which may be T cells, NK cells, or NK-like cells. Patients with LGL lymphocytosis may have moderate blood and bone marrow lymphocytosis, neutropenia, polyclonal hypergammaglobulinemia, splenomegaly, rheumatoid arthritis, and absence of lymphadenopathy. Such patients may have a chronic and relatively stable course. Recurrent bacterial infections are frequent. Benign and malignant forms of this syndrome occur. In some patients, a spontaneous regression has occurred even after 11 years, suggesting an immunoregulatory defect as the basis for at least one form of the disorder. Glucocorticoids, cyclosporine, IFN- $\alpha$ , and nucleosides such as 2-chlorodeoxyadenosine each have induced remission.

**Hereditary Neutropenias**

Hereditary neutropenias are rare and may manifest in early childhood as a profound constant neutropenia or agranulocytosis. Congenital forms of neutropenia include Kostmann's syndrome (neutrophil count <100/ $\mu$ L), which is often fatal due to mutations in the anti-apoptosis gene HAX-1; severe chronic neutropenia (neutrophil count of 300–1500/ $\mu$ L) due to mutations in neutrophil elastase; hereditary cyclic neutropenia, or, more appropriately, cyclic hematopoiesis, also due to mutations in neutrophil elastase; the cartilage-hair hypoplasia syndrome due to mutations in the mitochondrial RNA-processing endoribonuclease RMRP; Shwachman-Diamond syndrome associated with pancreatic insufficiency due to mutations in the Shwachman-Bodian-Diamond syndrome gene *SBDS*; the WHIM [warts, hypogammaglobulinemia, infections, myelokathexis (retention of WBCs in the marrow)] syndrome, characterized by neutrophil hypersegmentation and bone marrow myeloid arrest due to mutations in the chemokine receptor CXCR4; and neutropenias associated with other immune defects, such as X-linked agammaglobulinemia, Wiskott-Aldrich syndrome, and CD40 ligand deficiency. Mutations in the G-CSF receptor can develop in severe congenital neutropenia and are linked to leukemia.

Maternal factors can be associated with neutropenia in the newborn. Transplacental transfer of IgG directed against antigens on fetal neutrophils can result in peripheral destruction. Drugs (e.g., thiazides) ingested during pregnancy can cause neutropenia in the newborn by either depressed production or peripheral destruction.

In Felty's syndrome—the triad of rheumatoid arthritis, splenomegaly, and neutropenia-spleen-produced antibodies can shorten neutrophil life span while LGLs can attack marrow neutrophil precursors. Splenectomy may increase neutrophil count in Felty's syndrome and lower serum neutrophil-binding IgG. Some Felty's syndrome patients also have neutropenia associated with an increased number of LGLs. Splenomegaly with peripheral trapping and

occur a few hours after administration of the drug. Although any drug can cause this form of neutropenia, the most frequent causes are commonly used antibiotics, such as sulfa-containing compounds, penicillins, and cephalosporins. Fever and eosinophilia may also be associated with drug reactions, but often these signs are not present. Drug-induced neutropenia can be severe, but discontinuation of the sensitizing drug is sufficient for recovery, which is usually seen within 5–7 days and is complete by 10 days. Readministration of the sensitizing drug should be avoided because abrupt neutropenia will often result. For this reason, diagnostic challenge should be avoided.

Autoimmune neutropenias caused by circulating anti-neutrophil antibodies are another form of acquired neutropenia that results in increased destruction of neutrophils. Acquired neutropenia may also be seen with viral infections, including infection with HIV. Acquired neutropenia may be cyclic, occurring at intervals of several weeks. Acquired cyclic or stable neutropenia may be associated with an expansion of large granular lymphocytes

destruction of neutrophils is also seen in lysosomal storage diseases and in portal hypertension.

## Neutrophilia

Neutrophilia results from increased neutrophil production, increased marrow release, or defective margination (Table 5-2). The most important acute cause of neutrophilia is infection. Neutrophilia from acute infection represents both increased production and increased marrow release. Increased production is also associated with chronic inflammation and certain myeloproliferative diseases. Increased marrow release and mobilization of the marginated leukocyte pool are induced by glucocorticoids. Release of epinephrine, as with vigorous exercise, excitement, or stress, will demarginate neutrophils in the spleen and lungs and double the neutrophil count in minutes. Cigarette smoking can increase neutrophil counts into the abnormal range. Leukocytosis with cell counts of 10,000–25,000/ $\mu\text{L}$  occurs in response to infection and other forms of acute inflammation and results from both release of the marginated pool and mobilization of marrow reserves. Persistent neutrophilia with cell counts of  $\geq 30,000$ – $50,000/\mu\text{L}$  is called a *leukemoid reaction*, a term often used to distinguish this degree of neutrophilia from leukemia. In a leukemoid reaction, the circulating neutrophils are usually mature and not clonally derived.

TABLE 5-2

CAUSES OF NEUTROPHILIA
<b>Increased production</b>
Idiopathic
Drug—induced—glucocorticoids, G-CSF
Infection—bacterial, fungal, sometimes viral
Inflammation—thermal injury, tissue necrosis, myocardial and pulmonary infarction, hypersensitivity states, collagen vascular diseases
Myeloproliferative diseases—myelocytic leukemia, myeloid metaplasia, polycythemia vera
<b>Increased marrow release</b>
Glucocorticoids
Acute infection (endotoxin)
Inflammation—thermal injury
<b>Decreased or defective margination</b>
Drugs—epinephrine, glucocorticoids, nonsteroidal anti-inflammatory agents
Stress, excitement, vigorous exercise
Leukocyte adhesion deficiency type 1 (integrin $\beta$ chain, CD18); leukocyte adhesion deficiency type 2 (selectin ligand, CD15s, sialyl-Lewis <sup>x</sup> )
<b>Miscellaneous</b>
Metabolic disorders—ketoacidosis, acute renal failure, eclampsia, acute poisoning
Drugs—lithium
Other—metastatic carcinoma, acute hemorrhage or hemolysis

## Abnormal Neutrophil Function

Inherited and acquired abnormalities of phagocyte function are listed in Table 5-3. The resulting diseases are best considered in terms of the functional defects of adherence, chemotaxis, and microbicidal activity. The distinguishing features of the important inherited disorders of phagocyte function are shown in Table 5-4.

### Disorders of Adhesion

Two main types of leukocyte adhesion deficiency (LAD) have been described, LAD 1 and LAD 2. Both are autosomal recessive traits and result in the inability of neutrophils to exit the circulation to sites of infection, leading to leukocytosis and increased susceptibility to infection (Fig. 5-8). Patients with LAD 1 have mutations in CD18, the common component of the integrins LFA-1, Mac-1, and p150,95, leading to a defect in tight adhesion between neutrophils and the endothelium. The heterodimer formed by CD18/CD11b (Mac-1) is also the receptor for the complement-derived opsonin C3bi (CR3). The *CD18* gene is located on distal chromosome 21q. The severity of the defect determines the severity of clinical disease. Complete lack of expression of the leukocyte integrins results in a severe phenotype in which inflammatory stimuli do not increase the expression of leukocyte integrins on neutrophils or activated T and B cells. Neutrophils (and monocytes) from patients with LAD 1 adhere poorly to endothelial cells and protein-coated surfaces and exhibit defective spreading, aggregation, and chemotaxis. Patients with LAD 1 have recurrent bacterial infections involving the skin, oral and genital mucosa, and respiratory and intestinal tracts; persistent leukocytosis (neutrophil counts of 15,000–20,000/ $\mu\text{L}$ ) because cells do not marginate; and, in severe cases, a history of delayed separation of the umbilical stump. Infections, especially of the skin, may become necrotic with progressively enlarging borders, slow healing, and development of dysplastic scars. The most common bacteria are *Staphylococcus aureus* and enteric gram-negative bacteria. LAD 2 is caused by an abnormality of fucosylation of SLe<sup>x</sup> (CD15s), the ligand on neutrophils that interacts with selectins on endothelial cells and is responsible for neutrophil rolling along the endothelium. Infection susceptibility in LAD 2 appears to be less severe than in LAD 1. LAD 2 is also known as *congenital disorder of glycosylation IIc* (CDGIIc).

### Disorders of Neutrophil Granules

The most common neutrophil defect is myeloperoxidase deficiency, a primary granule defect inherited as an autosomal recessive trait; the incidence is  $\sim 1$  in 2000 persons. Isolated myeloperoxidase deficiency is not associated with clinically compromised defenses, presumably because other defense systems such as hydrogen peroxide generation

**TYPES OF GRANULOCYTE AND MONOCYTE DISORDERS**

FUNCTION	CAUSE OF INDICATED DYSFUNCTION		
	DRUG-INDUCED	ACQUIRED	INHERITED
Adherence-aggregation	Aspirin, colchicine, alcohol, glucocorticoids, ibuprofen, piroxicam	Neonatal state, hemodialysis	Leukocyte adhesion deficiency types 1 and 2
Deformability		Leukemia, neonatal state, diabetes mellitus, immature neutrophils	
Chemokinesis-chemotaxis	Glucocorticoids (high dose), auranofin, colchicine (weak effect), phenylbutazone, naproxen, indomethacin, interleukin 2	Thermal injury, malignancy, malnutrition, periodontal disease, neonatal state, systemic lupus erythematosus, rheumatoid arthritis, diabetes mellitus, sepsis, influenza virus infection, herpes simplex virus infection, acrodermatitis enteropathica, AIDS	Chédiak-Higashi syndrome, neutrophil-specific granule deficiency, hyper IgE–recurrent infection (Job’s) syndrome (in some patients), Down syndrome, $\alpha$ -mannosidase deficiency, severe combined immunodeficiency, Wiskott-Aldrich syndrome
Microbicidal activity	Colchicine, cyclophosphamide, glucocorticoids (high dose), TNF- $\alpha$ blocking antibodies	Leukemia, aplastic anemia, certain neutropenias, tuftsin deficiency, thermal injury, sepsis, neonatal state, diabetes mellitus, malnutrition, AIDS	Chédiak-Higashi syndrome, neutrophil-specific granule deficiency, chronic granulomatous disease, defects in IFN- $\gamma$ /IL-12 axis

are amplified. Microbicidal activity of neutrophils is delayed but not absent. Myeloperoxidase deficiency may make other acquired host defense defects more serious. An acquired form of myeloperoxidase deficiency occurs in myelomonocytic leukemia and acute myeloid leukemia.

Chédiak-Higashi syndrome (CHS) is a rare disease with autosomal recessive inheritance due to defects in the lysosomal transport protein *LYST*, encoded by the gene *CHS1* at 1q42. This protein is required for normal packaging and disbursement of granules. Neutrophils (and all cells containing lysosomes) from patients with CHS characteristically have large granules (Fig. 5–9) making it a systemic disease. Patients with CHS have nystagmus, partial oculocutaneous albinism, and an increased number of infections resulting from many bacterial agents. Some CHS patients develop an “accelerated phase” in childhood with a hemophagocytic syndrome and an aggressive lymphoma requiring bone marrow transplantation. CHS neutrophils and monocytes have impaired chemotaxis and abnormal rates of microbial killing due to slow rates of fusion of the lysosomal granules with phagosomes. NK cell function is also impaired. CHS patients may develop a severe disabling peripheral neuropathy in adulthood that can lead to bed confinement.

Specific granule deficiency is a rare autosomal recessive disease in which the production of secondary granules

and their contents, as well as the primary granule component defensins, is defective. The defect in bacterial killing leads to severe bacterial infections. One type of specific granule deficiency is due to a mutation in the CCAAT/enhancer binding protein- $\epsilon$ , a regulator of expression of granule components.

### Chronic Granulomatous Disease

Chronic granulomatous disease (CGD) is a group of disorders of granulocyte and monocyte oxidative metabolism. Although CGD is rare, with an incidence of 1 in 200,000 individuals, it is an important model of defective neutrophil oxidative metabolism. Most often CGD is inherited as an X-linked recessive trait; 30% of patients inherit the disease in an autosomal recessive pattern. Mutations in the genes for the four proteins that assemble at the plasma membrane account for all patients with CGD. Two proteins (a 91-kDa protein, abnormal in X-linked CGD, and a 22-kDa protein, absent in one form of autosomal recessive CGD) form the heterodimer cytochrome b-558 in the plasma membrane. Two other proteins (47 and 67 kDa, abnormal in the other autosomal recessive forms of CGD) are cytoplasmic in origin and interact with the cytochrome after cell activation to form NADPH oxidase, required for hydrogen peroxide production. Leukocytes from patients with CGD have severely diminished hydrogen peroxide production. The genes involved in each of the defects

TABLE 5-4

CLINICAL MANIFESTATIONS	CELLULAR OR MOLECULAR DEFECTS	DIAGNOSIS
<b>Chronic Granulomatous Diseases (70% X-Linked, 30% Autosomal Recessive)</b>		
Severe infections of skin, ears, lungs, liver, and bone with catalase-positive microorganisms such as <i>S. aureus</i> , <i>Burkholderia cepacia</i> , <i>Aspergillus</i> spp., <i>Chromobacterium violaceum</i> ; often hard to culture organism; excessive inflammation with granulomas, frequent lymph node suppuration; granulomas can obstruct GI or GU tracts; gingivitis, aphthous ulcers, seborrheic dermatitis	No respiratory burst due to the lack of one of four NADPH oxidase subunits in neutrophils, monocytes, and eosinophils	NBT or DHR test; no superoxide and H <sub>2</sub> O <sub>2</sub> production by neutrophils; immunoblot for NADPH oxidase components; genetic detection
<b>Chédiak-Higashi Syndrome (Autosomal Recessive)</b>		
Recurrent pyogenic infections, especially with <i>S. aureus</i> ; many patients get lymphoma-like illness during adolescence; periodontal disease; partial oculocutaneous albinism, nystagmus, progressive peripheral neuropathy, mental retardation in some patients	Reduced chemotaxis and phagolysosome fusion, increased respiratory burst activity, defective egress from marrow, abnormal skin window; defect in LYST	Giant primary granules in neutrophils and other granule-bearing cells (Wright's stain); genetic detection
<b>Specific Granule Deficiency (Autosomal Recessive)</b>		
Recurrent infections of skin, ears, and sinopulmonary tract; delayed wound healing; decreased inflammation; bleeding diathesis	Abnormal chemotaxis, impaired respiratory burst and bacterial killing, failure to upregulate chemotactic and adhesion receptors with stimulation, defect in transcription of granule proteins; defect in C/EBP $\epsilon$	Lack of secondary (specific) granules in neutrophils (Wright's stain), no neutrophil-specific granule contents (i.e., lactoferrin), no defensins, platelet $\alpha$ granule abnormality; genetic detection
<b>Myeloperoxidase Deficiency (Autosomal Recessive)</b>		
Clinically normal except in patients with underlying disease such as diabetes mellitus; then candidiasis or other fungal infections	No myeloperoxidase due to pre- and posttranslational defects	No peroxidase in neutrophils; genetic detection
<b>Leukocyte Adhesion Deficiency</b>		
Type 1: Delayed separation of umbilical cord, sustained neutrophilia, recurrent infections of skin and mucosa, gingivitis, periodontal disease	Impaired phagocyte adherence, aggregation, spreading, chemotaxis, phagocytosis of C3bi-coated particles; defective production of CD18 subunit common to leukocyte integrins	Reduced phagocyte surface expression of the CD18-containing integrins with monoclonal antibodies against LFA-1 (CD18/CD11a), Mac-1 or CR3 (CD18/CD11b), p150,95 (CD18/CD11c); genetic detection
Type 2: Mental retardation, short stature, Bombay (hh) blood phenotype, recurrent infections, neutrophilia	Impaired phagocyte rolling along endothelium	Reduced phagocyte surface expression of Sialyl-Lewis <sup>x</sup> , with monoclonal antibodies against CD15s; genetic detection
<b>Phagocyte Activation Defects (X-Linked and Autosomal Recessive)</b>		
NEMO deficiency: mild hypohidrotic ectodermal dysplasia; broad based immune defect: pyogenic and encapsulated bacteria, viruses, <i>Pneumocystis</i> , mycobacteria; X-linked	Impaired phagocyte activation by IL-1, IL-18, TLR, CD40, TNF- $\alpha$ leading to problems with inflammation and antibody production	Poor in vitro response to endotoxin; lack of NF- $\kappa$ B activation; genetic detection
IRAK4 deficiency: susceptibility to pyogenic bacteria such as staphylococci, streptococci, clostridia; resistant to mycobacteria; autosomal recessive	Impaired phagocyte activation by endotoxin through TLR and other pathways; TNF- $\alpha$ signaling preserved	Poor in vitro response to endotoxin; lack of NF- $\kappa$ B activation by endotoxin; genetic detection

(Continued)

## INHERITED DISORDERS OF PHAGOCYTE FUNCTION: DIFFERENTIAL FEATURES

CLINICAL MANIFESTATIONS	CELLULAR OR MOLECULAR DEFECTS	DIAGNOSIS
<b>Hyper IgE-Recurrent Infection Syndrome (Autosomal Dominant) (Job's Syndrome)</b>		
Ecematoid or pruritic dermatitis, "cold" skin abscesses, recurrent pneumonias with <i>S. aureus</i> with bronchopleural fistulae and cyst formation, mild eosinophilia, mucocutaneous candidiasis, characteristic facies, restrictive lung disease, scoliosis, delayed primary dental deciduation	Reduced chemotaxis in some patients, reduced suppressor T cell activity	Clinical features, involving lungs, skeleton, and immune system; serum IgE > 2000 IU/mL
<b>Mycobacteria Susceptibility (Autosomal Dominant and Recessive Forms)</b>		
Severe local or disseminated infections with bacille Calmette-Guérin (BCG), nontuberculous mycobacteria, salmonella, histoplasmosis, poor granuloma formation	Inability to kill intracellular organisms due to low IFN- $\gamma$ production; mutations in IFN- $\gamma$ receptors, IL-12 receptor, IL-12 p40, STAT-1, NEMO	Low or very high levels of IFN- $\gamma$ receptor 1; functional assays of cytokine production and response; genetic detection

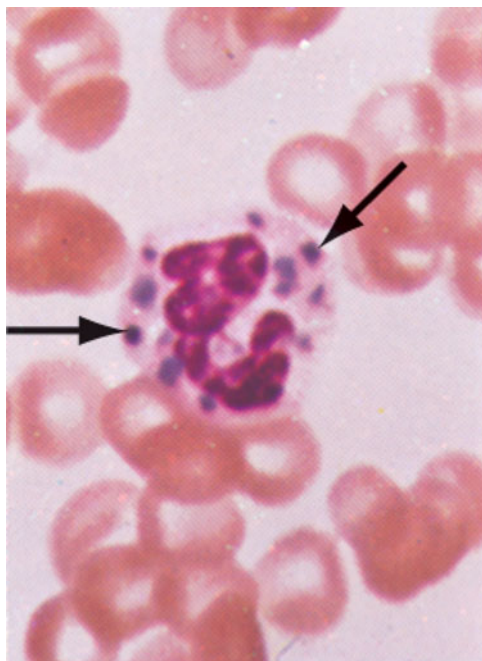
**Note:** GI, gastrointestinal; GU, genitourinary; NADPH, nicotinamide-adenine dinucleotide phosphate, NBT, nitroblue tetrazolium (dye test), DHR, dihydrorhodamine (oxidation test); LYST, lysosomal transport protein; C/EBP $\epsilon$ , CCAAT/enhancer binding protein- $\epsilon$ ; NEMO, NF- $\kappa$ B essential modulator; TLR, Toll-like receptor; IL, interleukin; TNF, tumor necrosis factor; IRAK4, IL-1 receptor-associated kinase protein- $\epsilon$ , NEMO 4; IFN, interferon.

have been cloned and sequenced and the chromosome locations identified. Patients with CGD characteristically have increased numbers of infections due to catalase-positive microorganisms (organisms that destroy their

own hydrogen peroxide). When patients with CGD become infected, they often have extensive inflammatory reactions, and lymph node suppuration is common despite the administration of appropriate antibiotics. Aphthous ulcers and chronic inflammation of the nares are often present. Granulomas are frequent and can obstruct the gastrointestinal or genitourinary tracts. The excessive inflammation probably reflects failure to inhibit the synthesis or degradation of chemoattractants and antigens, leading to persistent neutrophil accumulation. Impaired killing of intracellular microorganisms by macrophages may lead to persistent cell-mediated immune activation and granuloma formation. Autoimmune complications such as immune thrombocytopenic purpura and juvenile rheumatoid arthritis are also increased in CGD. In addition, discoid lupus is more common in X-linked carriers.

### Disorders of Phagocyte Activation

Phagocytes depend on cell-surface stimulation to induce signals that evoke multiple levels of the inflammatory response, including cytokine synthesis, chemotaxis, and antigen presentation. Mutations affecting the major pathway that signals through NF- $\kappa$ B have been noted in patients with a variety of infection susceptibility syndromes. If the defects are at a very late stage of signal transduction, in the protein critical for NF- $\kappa$ B activation known as the NF- $\kappa$ B essential modulator (NEMO), then affected males develop ectodermal dysplasia and severe immune deficiency with susceptibility to bacteria, fungi, mycobacteria, and viruses. If the defect in NF- $\kappa$ B activation



**FIGURE 5-9**

**Chédiak-Higashi syndrome.** The granulocytes contain huge cytoplasmic granules formed from aggregation and fusion of azurophilic and specific granules. Large abnormal granules are found in other granule-containing cells throughout the body.

is closer to the signaling source, in the IL-1 receptor-associated kinase 4 (IRAK4), then children have a marked susceptibility to pyogenic infections early in life but develop resistance to infection later.

## MONONUCLEAR PHAGOCYTES

The mononuclear phagocyte system is composed of monoblasts, promonocytes, and monocytes, in addition to the structurally diverse tissue macrophages that make up what was previously referred to as the reticuloendothelial system. Macrophages are long-lived phagocytic cells capable of many of the functions of neutrophils. They are also secretory cells that participate in many immunologic and inflammatory processes distinct from neutrophils. Monocytes leave the circulation by diapedesis more slowly than neutrophils and have a half-life in the blood of 12–24 hours.

After blood monocytes arrive in the tissues, they differentiate into macrophages (“big eaters”) with specialized functions suited for specific anatomic locations. Macrophages are particularly abundant in capillary walls of the lung, spleen, liver, and bone marrow, where they function to remove microorganisms and other noxious elements from the blood. Alveolar macrophages, liver Kupffer cells, splenic macrophages, peritoneal macrophages, bone marrow macrophages, lymphatic macrophages, brain microglial cells, and dendritic macrophages all have specialized functions. Macrophage-secreted products include lysozyme, neutral proteases, acid hydrolases, arginase, complement components, enzyme inhibitors (plasmin,  $\alpha_2$ -macroglobulin), binding proteins (transferrin, fibronectin, transcobalamin II), nucleosides, and cytokines (TNF- $\alpha$ ; IL-1, -8, -12, -18). IL-1 has many functions, including initiating fever in the hypothalamus, mobilizing leukocytes from the bone marrow, and activating lymphocytes and neutrophils. TNF- $\alpha$  is a pyrogen that duplicates many of the actions of IL-1 and plays an important role in the pathogenesis of gram-negative shock. TNF- $\alpha$  stimulates production of hydrogen peroxide and related toxic oxygen species by macrophages and neutrophils. In addition, TNF- $\alpha$  induces catabolic changes that contribute to the profound wasting (cachexia) associated with many chronic diseases.

Other macrophage-secreted products include reactive oxygen and nitrogen metabolites, bioactive lipids (arachidonic acid metabolites and platelet-activating factors), chemokines, CSFs, and factors stimulating fibroblast and vessel proliferation. Macrophages help regulate the replication of lymphocytes and participate in the killing of tumors, viruses, and certain bacteria (*Mycobacterium tuberculosis* and *Listeria monocytogenes*). Macrophages are key effector cells in the elimination of intracellular microorganisms. Their ability to fuse to form giant cells that coalesce into granulomas in response to some inflammatory

stimuli is important in the elimination of intracellular microbes and is under the control of IFN- $\gamma$ . Nitric oxide induced by IFN- $\gamma$  is an important effector against intracellular parasites, including tuberculosis and *Leishmania*.

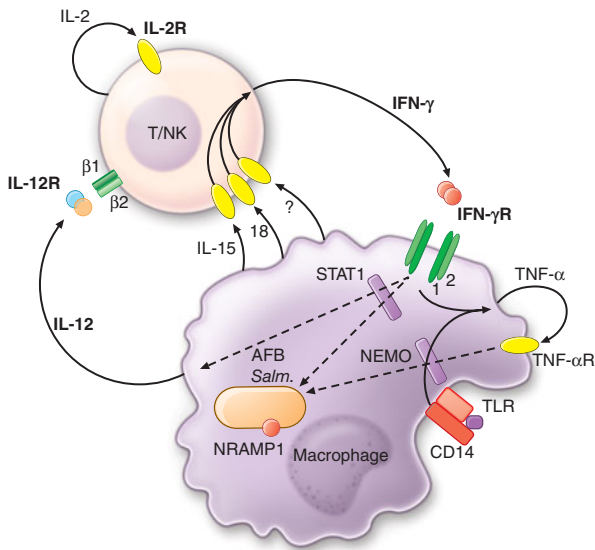
Macrophages play an important role in the immune response. They process and present antigen to lymphocytes and secrete cytokines that modulate and direct lymphocyte development and function. Macrophages participate in autoimmune phenomena by removing immune complexes and other substances from the circulation. Polymorphisms in macrophage receptors for immunoglobulin (Fc $\gamma$ RII) determine susceptibility to some infections and autoimmune diseases. In wound healing, they dispose of senescent cells, and they contribute to atheroma development. Macrophage elastase mediates development of emphysema from cigarette smoking.

## DISORDERS OF THE MONONUCLEAR PHAGOCYTE SYSTEM

Many disorders of neutrophils extend to mononuclear phagocytes. Thus drugs that suppress neutrophil production in the bone marrow can cause monocytopenia. Transient monocytopenia occurs after stress or glucocorticoid administration. Monocytosis is associated with tuberculosis, brucellosis, subacute bacterial endocarditis, Rocky Mountain spotted fever, malaria, and visceral leishmaniasis (kala azar). Monocytosis also occurs with malignancies, leukemias, myeloproliferative syndromes, hemolytic anemias, chronic idiopathic neutropenias, and granulomatous diseases such as sarcoidosis, regional enteritis, and some collagen vascular diseases. Patients with LAD, hyperimmunoglobulin E–recurrent infection (Job’s) syndrome, CHS, and CGD all have defects in the mononuclear phagocyte system.

Monocyte cytokine production or response is impaired in some patients with disseminated nontuberculous mycobacterial infection who are not infected with HIV. Genetic defects in the pathways regulated by IFN- $\gamma$  and IL-12 lead to impaired killing of intracellular bacteria, mycobacteria, salmonellae, and certain viruses (Fig. 5–10).

Certain viral infections impair mononuclear phagocyte function. For example, influenza virus infection causes abnormal monocyte chemotaxis. Mononuclear phagocytes can be infected by HIV using CCR5, the chemokine receptor that acts as a co-receptor with CD4 for HIV. T lymphocytes produce IFN- $\gamma$ , which induces FcR expression and phagocytosis and stimulates hydrogen peroxide production by mononuclear phagocytes and neutrophils. In certain diseases, such as AIDS, IFN- $\gamma$  production may be deficient, whereas in other diseases, such as T cell lymphomas, excessive release of IFN- $\gamma$  may be associated with erythrophagocytosis by splenic macrophages.

**FIGURE 5-10**

**Lymphocyte-macrophage interactions underlying resistance to mycobacteria** and other intracellular parasites such as *Salmonella*. Mycobacteria infect macrophages, leading to the production of IL-12, which activates T or NK cells through its receptor, leading to production of IL-2 and IFN- $\gamma$ . IFN- $\gamma$  acts through its receptor on macrophages to upregulate TNF- $\alpha$  and IL-12 and kill intracellular parasites. Mutant forms of the cytokines and receptors shown in bold type have been found in severe cases of nontuberculous mycobacterial infection and salmonellosis.

Autoinflammatory diseases are characterized by abnormal cytokine regulation leading to excess inflammation in the absence of infection. These diseases can mimic infectious or immunodeficient syndromes. Gain-of-function mutations in the TNF- $\alpha$  receptor cause TNF- $\alpha$  receptor-associated periodic syndrome (TRAPS), which is characterized by recurrent fever in the absence of infection, due to persistent stimulation of the TNF- $\alpha$  receptor. Diseases with abnormal IL-1 regulation leading to fever include familial Mediterranean fever due to mutations in *pyrin*. Mutations in *cold-induced autoinflammatory syndrome 1* lead to neonatal onset multisystem autoinflammatory disease, familial cold urticaria, and Muckle-Wells syndrome. Pyoderma gangrenosum, acne, and sterile pyogenic arthritis is caused by mutations in CD2BP1. In contrast to these syndromes of overexpression of proinflammatory cytokines, blockade of TNF- $\alpha$  by the antagonists infliximab, etanercept, and adalimumab has been associated with severe infections due to tuberculosis, nontuberculous mycobacteria, and fungi.

Monocytopenia occurs with acute infections, with stress, and after treatment with glucocorticoids. Monocytopenia also occurs in aplastic anemia, hairy cell leukemia, acute myeloid leukemia, and as a direct result of myelotoxic drugs.

## EOSINOPHILS

Eosinophils and neutrophils share similar morphology, many lysosomal constituents, phagocytic capacity, and oxidative metabolism. Eosinophils express a specific chemoattractant receptor and respond to a specific chemokine, eotaxin. Little is known about the role of eosinophils. Eosinophils are much longer lived than neutrophils, and unlike neutrophils, tissue eosinophils can recirculate. During most infections, eosinophils are not important. However, in invasive helminthic infections, such as hookworm, schistosomiasis, strongyloidiasis, toxocarasis, trichinosis, filariasis, echinococcosis, and cysticercosis, the eosinophil plays a central role in host defense. Eosinophils are associated with bronchial asthma, cutaneous allergic reactions, and other hypersensitivity states.

The distinctive feature of the red-staining (Wright's stain) eosinophil granule is its crystalline core consisting of an arginine-rich protein (major basic protein) with histaminase activity, important in host defense against parasites. Eosinophil granules also contain a unique eosinophil peroxidase that catalyzes the oxidation of many substances by hydrogen peroxide and may facilitate killing of microorganisms.

Eosinophil peroxidase, in the presence of hydrogen peroxide and halide, initiates mast cell secretion in vitro and thereby promotes inflammation. Eosinophils contain cationic proteins, some of which bind to heparin and reduce its anticoagulant activity. Eosinophil-derived neurotoxin and eosinophil cationic protein are ribonucleases that can kill respiratory syncytial virus. Eosinophil cytoplasm contains Charcot-Leyden crystal protein, a hexagonal bipyramidal crystal first observed in a patient with leukemia and then in sputum of patients with asthma; this protein is lysophospholipase and may function to detoxify certain lysophospholipids.

Several factors enhance the eosinophil's function in host defense. T cell-derived factors enhance the ability of eosinophils to kill parasites. Mast cell-derived eosinophil chemotactic factor of anaphylaxis (ECFa) increases the number of eosinophil complement receptors and enhances eosinophil killing of parasites. Eosinophil CSFs (e.g., IL-5) produced by macrophages increase eosinophil production in the bone marrow and activate eosinophils to kill parasites.

## EOSINOPHILIA

Eosinophilia is the presence of  $>500$  eosinophils/ $\mu\text{L}$  of blood and is common in many settings besides parasite infection. Significant tissue eosinophilia can occur without an elevated blood count. A common cause of eosinophilia is allergic reaction to drugs (iodides, aspirin, sulfonamides, nitrofurantoin, penicillins, and cephalosporins). Allergies

such as hay fever, asthma, eczema, serum sickness, allergic vasculitis, and pemphigus are associated with eosinophilia. Eosinophilia also occurs in collagen vascular diseases (e.g., rheumatoid arthritis, eosinophilic fasciitis, allergic angiitis, and periarteritis nodosa) and malignancies (e.g., Hodgkin's disease; mycosis fungoides; chronic myeloid leukemia; and cancer of the lung, stomach, pancreas, ovary, or uterus), as well as in Job's syndrome and CGD. Eosinophilia is commonly present in the helminthic infections. IL-5 is the dominant eosinophil growth factor. Therapeutic administration of the cytokines IL-2 and GM-CSF frequently leads to transient eosinophilia. The most dramatic hypereosinophilic syndromes are Loeffler's syndrome, tropical pulmonary eosinophilia, Loeffler's endocarditis, eosinophilic leukemia, and idiopathic hypereosinophilic syndrome (50,000–100,000/ $\mu$ L).

The idiopathic hypereosinophilic syndrome represents a heterogeneous group of disorders with the common feature of prolonged eosinophilia of unknown cause and organ system dysfunction, including the heart, central nervous system, kidneys, lungs, gastrointestinal tract, and skin. The bone marrow is involved in all affected individuals, but the most severe complications involve the heart and central nervous system. Clinical manifestations and organ dysfunction are highly variable. Eosinophils are found in the involved tissues and likely cause tissue damage by local deposition of toxic eosinophil proteins such as eosinophil cationic protein and major basic protein. In the heart, the pathologic changes lead to thrombosis, endocardial fibrosis, and restrictive endomyocardialopathy. The damage to tissues in other organ systems is similar. Some cases are due to mutations involving the platelet-derived growth factor receptor, and these are extremely sensitive to the tyrosine kinase inhibitor imatinib. Glucocorticoids, hydroxyurea, and IFN- $\alpha$  each have been used successfully, as have therapeutic antibodies against IL-5. Cardiovascular complications are managed aggressively.

The *eosinophilia-myalgia syndrome* is a multisystem disease, with prominent cutaneous, hematologic, and visceral manifestations, that frequently evolves into a chronic course and can occasionally be fatal. The syndrome is characterized by eosinophilia (eosinophil count  $>1000/\mu$ L) and generalized disabling myalgias without other recognized causes. Eosinophilic fasciitis, pneumonitis, and myocarditis; neuropathy culminating in respiratory failure; and encephalopathy may occur. The disease is caused by ingesting contaminants in L-tryptophan-containing products. Eosinophils, lymphocytes, macrophages, and fibroblasts accumulate in the affected tissues, but their role in pathogenesis is unclear. Activation of eosinophils and fibroblasts and the deposition of eosinophil-derived toxic proteins in affected tissues may contribute. IL-5 and transforming growth factor  $\beta$  have been implicated as potential mediators. Treatment is withdrawal of products containing L-tryptophan and the administration of glucocorticoids.

Most patients recover fully, remain stable, or show slow recovery, but the disease can be fatal in up to 5% of patients.

## EOSINOPENIA

Eosinopenia occurs with stress, such as acute bacterial infection, and after treatment with glucocorticoids. The mechanism of eosinopenia of acute bacterial infection is unknown but is independent of endogenous glucocorticoids because it occurs in animals after total adrenalectomy. There is no known adverse effect of eosinopenia.

## HYPERIMMUNOGLOBULIN E-RECURRENT INFECTION SYNDROME

The hyperimmunoglobulin E–recurrent infection syndrome, or Job's syndrome, is a rare multisystem disease in which the immune system, bone, teeth, lung, and skin are affected. Abnormal chemotaxis is a variable feature. The molecular basis for this syndrome is still not known, but some cases show clear autosomal dominant transmission with linkage to 4q. Patients with this syndrome have characteristic facies with broad nose, kyphoscoliosis and osteoporosis, and eczema. The primary teeth erupt normally but do not deciduate, often requiring extraction. Patients develop recurrent sinopulmonary and cutaneous infections that tend to be much less inflamed than appropriate for the degree of infection and have been referred to as “cold abscesses.” A high degree of suspicion is required to diagnose infections in these patients, who may appear well despite extensive disease. The cold abscesses have been considered a reflection of too few phagocytes arriving too late, perhaps due to a lymphocyte factor inhibiting chemotaxis. However, the chemotactic defect in these patients is variable, and the fundamental basis for the impaired defenses is complex and poorly defined.

## LABORATORY DIAGNOSIS AND MANAGEMENT

Initial studies of WBC and differential and often a bone marrow examination may be followed by assessment of bone marrow reserves (steroid challenge test), marginated circulating pool of cells (epinephrine challenge test), and marginating ability (endotoxin challenge test) (Fig. 5-7). In vivo assessment of inflammation is possible with a Rebutck skin window test or an in vivo skin blister assay, which measures the ability of leukocytes and inflammatory mediators to accumulate locally in the skin. In vitro tests of phagocyte aggregation, adherence, chemotaxis, phagocytosis, degranulation, and microbicidal activity (for *S. aureus*) may help pinpoint cellular or



56 humoral lesions. Deficiencies of oxidative metabolism are detected with either the nitroblue tetrazolium (NBT) dye test or the dihydrorhodamine (DHR) oxidation test. These tests are based on the ability of products of oxidative metabolism to alter the oxidation states of reporter molecules so that they can be detected microscopically (NBT) or by flow cytometry (DHR). Qualitative studies of superoxide and hydrogen peroxide production may further define neutrophil oxidative function.

Patients with leukopenias or leukocyte dysfunction often have delayed inflammatory responses. Therefore, clinical manifestations may be minimal despite overwhelming infection, and unusual infections must always be suspected. Early signs of infection demand prompt, aggressive culturing for microorganisms, use of antibiotics, and surgical drainage of abscesses. Prolonged courses of antibiotics are often required. In patients with CGD, prophylactic antibiotics (trimethoprim-sulfamethoxazole) and antifungals (itraconazole) markedly diminish the frequency of life-threatening infections. Short courses of glucocorticoids may relieve gastrointestinal or genitourinary tract obstruction by granulomas in patients with CGD. Recombinant human IFN- $\gamma$ , which nonspecifically stimulates phagocytic cell function, reduces the frequency of infections in patients with CGD by 70% and reduces the severity of infection. This effect of IFN- $\gamma$  in CGD is additive to the effect of prophylactic antibiotics. The recommended dose is 50  $\mu\text{g}/\text{m}^2$  subcutaneously three times weekly. IFN- $\gamma$  has also been used successfully in the treatment of leprosy, nontuberculous mycobacteria, and visceral leishmaniasis.

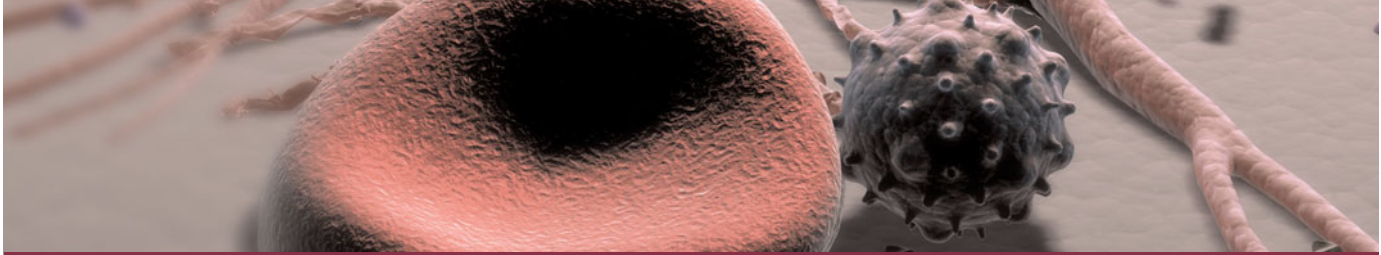
Rigorous oral hygiene reduces but does not eliminate the discomfort of gingivitis, periodontal disease, and aphthous ulcers; chlorhexidine mouthwash and tooth brushing with a hydrogen peroxide-sodium bicarbonate paste helps many patients. Oral antifungal agents (fluconazole or itraconazole) have reduced mucocutaneous candidiasis in patients with Job's syndrome. Androgens, glucocorticoids, lithium, and immunosuppressive therapy have been used to restore myelopoiesis in patients with neutropenia due to impaired production. Recombinant G-CSF is useful in the management of certain forms of neutropenia due to depressed neutrophil production, especially those related to cancer chemotherapy. Patients with chronic neutropenia with evidence of a good bone marrow reserve need not receive prophylactic antibiotics. Patients with chronic or cyclic neutrophil counts  $<500/\mu\text{L}$  may benefit from prophylactic antibiotics and G-CSF during periods of neutropenia. Oral trimethoprim-sulfamethoxazole (160/800 mg) twice daily can prevent infection. Increased numbers of fungal infections are not seen in patients with CGD on this regimen. Oral quinolones such as levofloxacin and ciprofloxacin are alternatives.

In the setting of cytotoxic chemotherapy with severe, persistent neutropenia, trimethoprim-sulfamethoxazole prevents *Pneumocystis jiroveci* pneumonia. These patients, and patients with phagocytic cell dysfunction, should avoid heavy exposure to airborne soil, dust, or decaying matter (mulch, manure), which are often rich in *Nocardia* and the spores of *Aspergillus* and other fungi. Restriction of activities or social contact has no proven role in reducing risk of infection.

Cure of some congenital phagocyte defects is possible by bone marrow transplantation (Chap. 29). However, complications of bone marrow transplantation are still serious, and with rigorous medical care many patients with phagocytic disorders can go for years without a life-threatening infection. The identification of specific gene defects in patients with LAD 1, CGD, and other immunodeficiencies has led to gene therapy trials in a number of genetic white cell disorders.

## FURTHER READINGS

- ARRUDA MA, BARJA-FIDALGO C: NADPH oxidase activity: In the crossroad of neutrophil life and death. *Front Biosci* 14:4546, 2009
- GRIMBACHER B et al: Hyper-IgE syndromes. *Immunol Rev* 203:244, 2005
- HORWITZ MS et al: Neutrophil elastase in cyclic and severe congenital neutropenia. *Blood* 109:1817, 2007
- KLION AD et al: Approaches to the treatment of hypereosinophilic syndromes: A workshop summary report. *J Allergy Clin Immunol* 117:1292, 2006
- MEYER-HOFFER U: Neutrophil-derived serine proteases modulate innate immune responses. *Front Biosci* 14:3409, 2009
- NATHAN C: Neutrophils and immunity: Challenges and opportunities. *Nat Rev Immunol* 6:173, 2006
- PINHEIRO DA SILVA F, SORIANO FG: Neutrophils recruitment during sepsis: Critical points and crossroads. *Front Biosci* 14:4464, 2009
- PUEL A et al: Heritable defects of the human TLR signalling pathways. *J Endotoxin Res* 11:220, 2005
- ROSENZWEIG SD, HOLLAND SM: Phagocyte immunodeficiencies and their infections. *J Allergy Clin Immunol* 113:620, 2004
- SEGAL BH et al: Genetic, biochemical, and clinical features of chronic granulomatous disease. *Medicine (Baltimore)* 79:170, 2000
- VALENT P: Pathogenesis, classification, and therapy of eosinophilia and eosinophil disorders. *Blood Rev* 23:157, 2009
- LUSTER AD et al: Immune cell migration in inflammation: Present and future therapeutic targets. *Nat Immunol* 6:1182, 2005
- MEDVEDEV AE et al: Cutting edge: Expression of IL-1 receptor-associated kinase-4 (IRAK-4) proteins with mutations identified in a patient with recurrent bacterial infections alters normal IRAK-4 interaction with components of the IL-1 receptor complex. *J Immunol* 174:6587, 2005
- SALIU OY et al: Tumor-necrosis-factor blockers: Differential effects on mycobacterial immunity. *J Infect Dis* 194:486, 2006
- STOJANOV S, KASTNER DL: Familial autoinflammatory diseases: Genetics, pathogenesis and treatment. *Curr Opin Rheumatol* 17:586, 2005
- WINKELSTEIN JA et al: Chronic granulomatous disease. Report on a national registry of 368 patients. *Medicine (Baltimore)* 79:155, 2000



## CHAPTER 6

# ATLAS OF HEMATOLOGY AND ANALYSIS OF PERIPHERAL BLOOD SMEARS

Dan L. Longo

Some of the relevant findings in peripheral blood, enlarged lymph nodes, and bone marrow are illustrated here. Systematic histologic examination of the bone marrow and lymph node are beyond the scope of a general medicine textbook. However, every internist should know how to examine a peripheral blood smear.

The examination of the peripheral blood smear is one of the most informative exercises a physician can perform. Although advances in automated technology have made the examination of the peripheral blood smear by the physician seem less important, the technology is not a completely satisfactory replacement for blood smear interpretation by a trained medical professional who also knows the patient's clinical history, family history, social history, and physical findings. It is useful to ask the laboratory to generate a Wright's-stained peripheral blood smear and to examine it.

The best place to examine blood cell morphology is the feathered edge of the blood smear where red cells lie in a single layer, side by side, just barely touching each other but not overlapping. My own approach is to look at the smallest cellular elements first, the platelets, and work my way up in size to red cells and then white cells.

Using an oil immersion lens that magnifies the cells 100-fold, one first counts the platelets in five to six fields, averages the number per field, and multiplies by 20,000 to get a rough estimate of the platelet count. The platelets are usually 1–2  $\mu\text{m}$  in diameter and have a blue granulated appearance. There is usually 1 platelet for every 20 or so red cells. Of course, the automated counter is much more accurate, but gross disparities between the automated and manual counts should be assessed. Large platelets may be a sign of rapid platelet turnover because young platelets are often larger than old platelets; alternatively, certain rare inherited syndromes can produce large platelets. Platelet clumping visible on the smear can be associated with falsely low automated

platelet counts. Similarly, neutrophil fragmentation can be a source of falsely elevated automated platelet counts.

Next one examines the red blood cells. One can gauge their size by comparing the red cell to the nucleus of a small lymphocyte. Both are normally  $\sim 8 \mu\text{m}$  wide. Red cells that are smaller than the small lymphocyte nucleus may be microcytic; those larger than the small lymphocyte nucleus may be macrocytic. The automated mean corpuscular volume (MCV) can assist in making a classification. However, some patients may have both iron and vitamin B<sub>12</sub> deficiency, which will produce an MCV in the normal range but wide variation in red cell size. When the red cells vary greatly in size, *anisocytosis* is said to be present. When the red cells vary greatly in shape, *poikilocytosis* is said to be present.

After red cell size is assessed, one examines the hemoglobin content of the cells. They are either normal in color (*normochromic*) or pale in color (*hypochromic*). They are never “hyperchromic.” If more than the normal amount of hemoglobin is made, the cells get larger—they do not become darker. In addition to hemoglobin content, the red cells are examined for inclusions. Red cell inclusions are the following:

1. *Basophilic stippling*—diffuse fine or coarse blue dots in the red cell representing usually RNA residue—especially common in lead poisoning
2. *Howell-Jolly bodies*—dense blue circular inclusions that represent nuclear remnants—their presence implies defective splenic function
3. *Nuclei*—red cells may be released or pushed out of the marrow prematurely before nuclear extrusion—often implies a myelophthitic process
4. *Parasites*—red cell parasites include malaria and *Babesia*
5. *Polychromatophilia*—the red cell cytoplasm has a bluish hue, reflecting the persistence of ribosomes still actively making hemoglobin in a young red cell

58 Vital stains are necessary to see precipitated hemoglobin called *Heinz bodies*.

Red cells can take on a variety of different shapes. All abnormally shaped red cells are *poikilocytes*. Small red cells without the central pallor are *spherocytes*; they can be seen in hereditary spherocytosis, hemolytic anemias of other causes, and clostridial sepsis. *Dacrocytes* are teardrop-shaped cells that can be seen in hemolytic anemias, severe iron deficiency, thalassemias, myelofibrosis, and myelodysplastic syndromes. *Schistocytes* are helmet-shaped cells that reflect microangiopathic hemolytic anemia or fragmentation on an artificial heart valve. *Echinocytes* are spiculated red cells with the spikes evenly spaced; they can represent an artifact of abnormal drying of the blood smear or reflect changes in stored blood. They can also be seen in renal failure and malnutrition and are often reversible. *Acanthocytes* are spiculated red cells with the spikes irregularly distributed. This process tends to be irreversible and reflects underlying renal disease, abetalipoproteinemia, or splenectomy. *Elliptocytes* are elliptical-shaped red cells that can reflect an inherited defect in the red cell membrane, but they are also seen in iron deficiency, myelodysplastic syndrome, megaloblastic anemia, and thalassemias. *Stomatocytes* are red cells in which the area of central pallor takes on the morphology of a slit instead of the usual round shape. Stomatocytes can indicate an inherited red cell membrane defect and can also be seen in alcoholism. *Target cells* have an area of central pallor that contains a dense center, or bull's-eye. These cells are seen classically in thalassemia, but they are also present in iron deficiency, cholestatic liver disease, and some hemoglobinopathies. They can also be generated artifactually by improper slide making.

One last feature of the red cells to assess before moving to the white blood cells is the distribution of the red cells on the smear. In most individuals, the cells lie side by side in a single layer. Some patients have red cell clumping (called *agglutination*) in which the red cells pile upon one another; it is seen in certain paraproteinemias and autoimmune hemolytic anemias. Another abnormal distribution involves red cells lying in single cell rows on top of one another like stacks of coins. This is called *rouleaux formation* and reflects abnormal serum protein levels.

Finally, one examines the white blood cells. Three types of granulocytes are usually present: neutrophils, eosinophils, and basophils, in decreasing frequency. Neutrophils are generally the most abundant white cell. They are round, 10–14  $\mu\text{m}$  wide, and contain a lobulated nucleus with two to five lobes connected by a thin chromatin thread. Bands are immature neutrophils that have not yet completed nuclear condensation and have a U-shaped nucleus. Bands reflect a left shift in neutrophil maturation in an effort to make more cells more rapidly.

Neutrophils can provide clues to a variety of conditions. Vacuolated neutrophils may be a sign of bacterial sepsis. The presence of 1- to 2- $\mu\text{m}$  blue cytoplasmic inclusions, called *Dohle bodies*, can reflect infections, burns, or other inflammatory states. If the neutrophil granules are larger than normal and stain a darker blue, “toxic granulations” are said to be present, and they also suggest a systemic inflammation. The presence of neutrophils with more than five nuclear lobes suggests megaloblastic anemia. Large misshapen granules may reflect the inherited Chédiak-Higashi syndrome.

Eosinophils are slightly larger than neutrophils, have bilobed nuclei, and contain large red granules. Diseases of eosinophils are associated with too many of them rather than any morphologic or qualitative change. They normally total less than one-thirtieth the number of neutrophils. Basophils are even rarer than eosinophils in the blood. They have large dark-blue granules and may be increased as part of chronic myeloid leukemia.

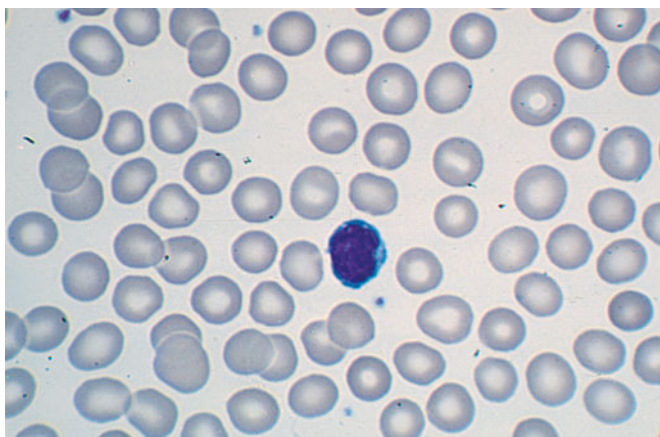
Lymphocytes can be present in several morphologic forms. Most common in healthy individuals are the small lymphocytes with a small dark nucleus and scarce cytoplasm. In the presence of viral infections, more of the lymphocytes are larger, about the size of neutrophils, with abundant cytoplasm and a less condensed nuclear chromatin. These are called *reactive lymphocytes*. About 1% of the lymphocytes are larger and contain blue granules in a light blue cytoplasm; these are called *large granular lymphocytes*. In chronic lymphoid leukemia, the small lymphocytes are increased in number, and many of them are ruptured in making the blood smear, leaving a smudge of nuclear material without a surrounding cytoplasm or cell membrane; these are called *smudge cells* and are rare in the absence of chronic lymphoid leukemia.

Monocytes are the largest white blood cells, ranging from 15–22  $\mu\text{m}$  in diameter. The nucleus can take on a variety of shapes but usually appears to be folded; the cytoplasm is gray.

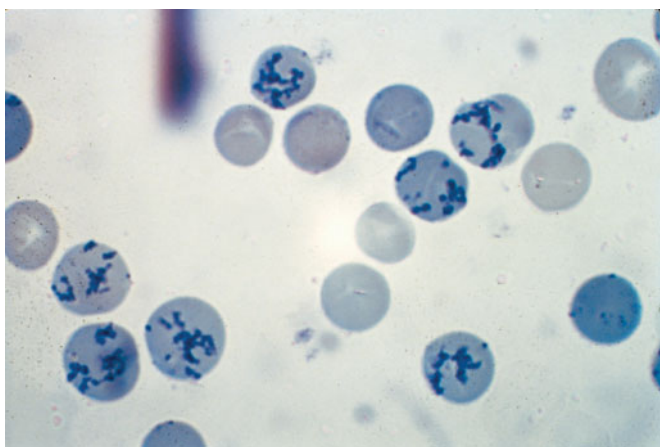
Abnormal cells may appear in the blood. Most often the abnormal cells originate from neoplasms of bone marrow-derived cells including lymphoid cells, myeloid cells, and occasionally red cells. More rarely, other types of tumors can get access to the bloodstream, and rare epithelial malignant cells may be identified. The chances of seeing such abnormal cells is increased by examining blood smears made from buffy coats, the layer of cells that is visible on top of sedimenting red cells when blood is left in the test tube for an hour. Smears made from fingersticks may include rare endothelial cells.

#### ACKNOWLEDGMENT

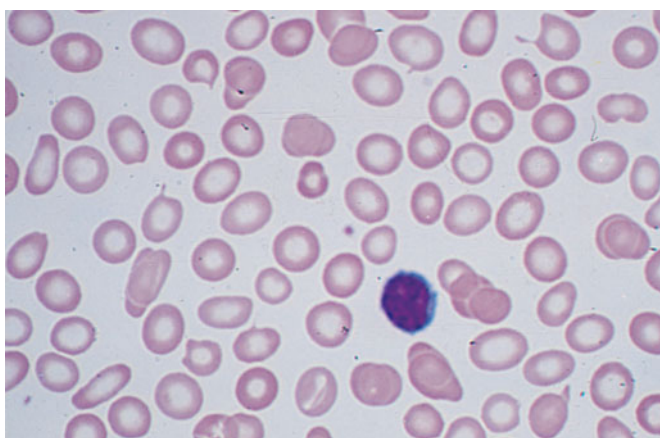
Figures in this chapter were borrowed from Williams Hematology, 7th edition, M Lichtman et al (eds). New York, McGraw-Hill, 2005; Hematology in General Practice, 4th edition, RS Hillman, KA Ault, New York, McGraw-Hill, 2005.

**FIGURE 6-1**

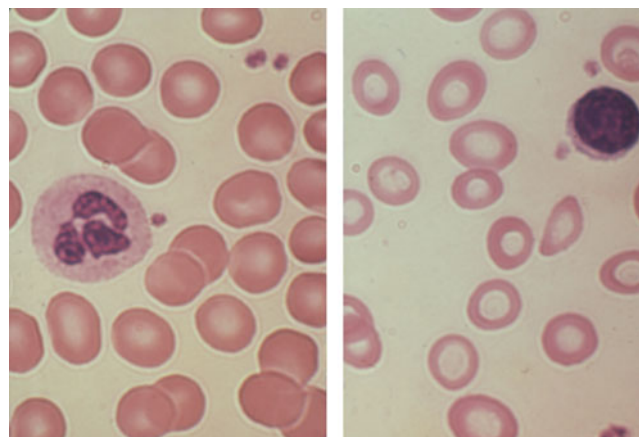
**Normal peripheral blood smear.** Small lymphocyte in center of field. Note that the diameter of the red blood cell is similar to the diameter of the small lymphocyte nucleus.

**FIGURE 6-2**

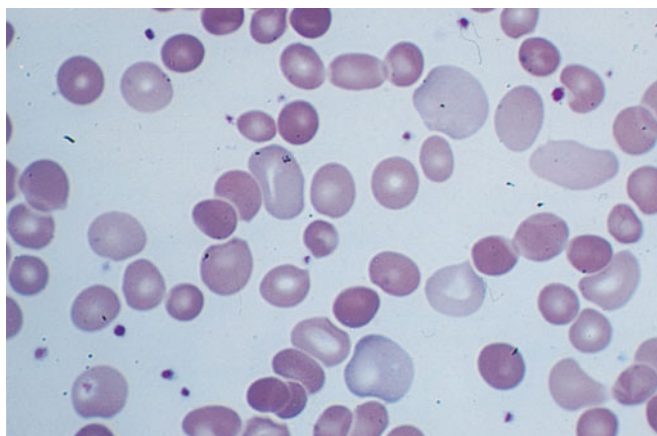
**Reticulocyte count preparation.** This new methylene blue-stained blood smear shows large numbers of heavily stained reticulocytes (the cells containing the dark blue-staining RNA precipitates).

**FIGURE 6-3**

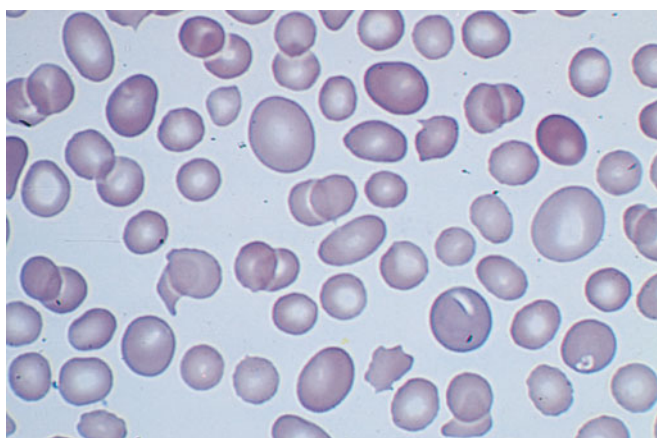
**Hypochromic microcytic anemia of iron deficiency.** Small lymphocyte in field helps assess the red blood cell size.

**FIGURE 6-4**

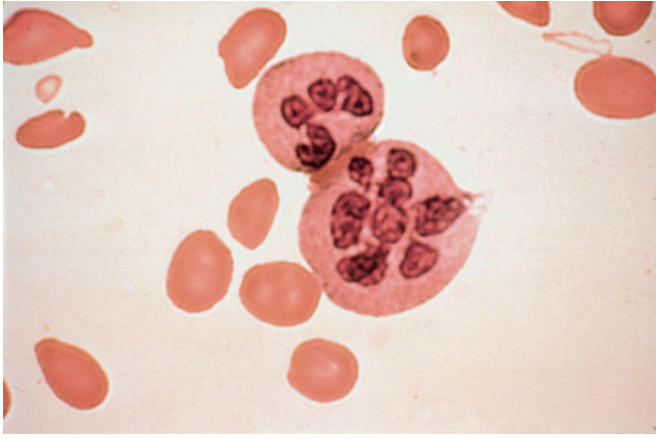
**Iron deficiency anemia next to normal red blood cells.** Microcytes (*right panel*) are smaller than normal red blood cells (cell diameter  $<7 \mu\text{m}$ ) and may or may not be poorly hemoglobinized (hypochromic).

**FIGURE 6-5**

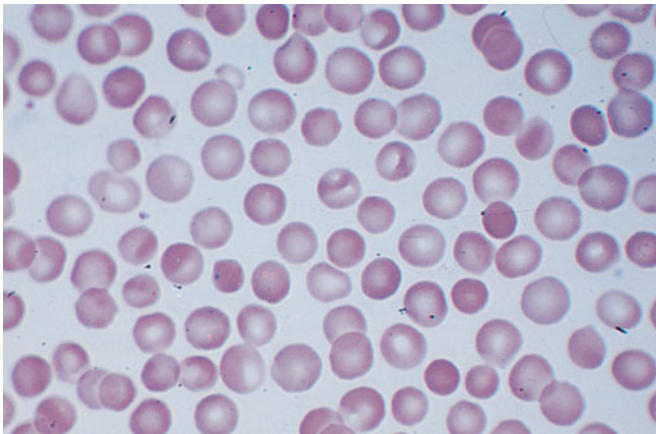
**Polychromatophilia.** Note large red cells with light purple coloring.

**FIGURE 6-6**

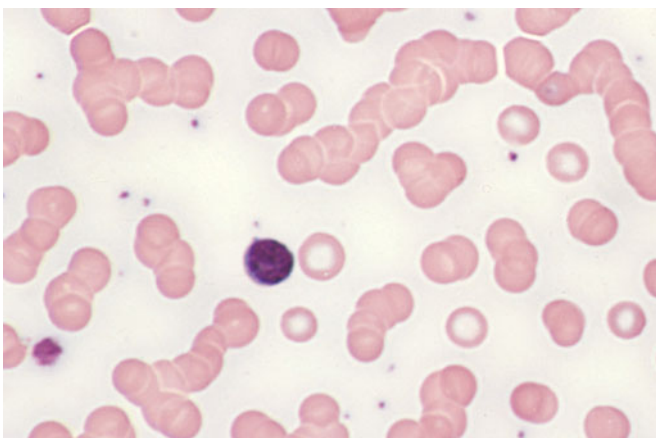
**Macrocytosis.** These cells are both larger than normal (mean corpuscular volume  $>100$ ) and are somewhat oval in shape. Some morphologists call these cells "macroovalocytes."

**FIGURE 6-7**

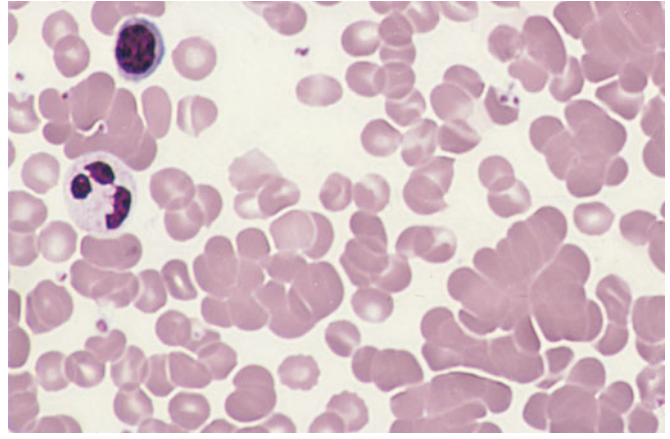
**Hypersegmented neutrophils.** Hypersegmented neutrophils (multilobed polymorphonuclear leukocytes) are larger than normal neutrophils with five or more segmented nuclear lobes. They are commonly seen with folic acid or vitamin B<sub>12</sub> deficiency.

**FIGURE 6-8**

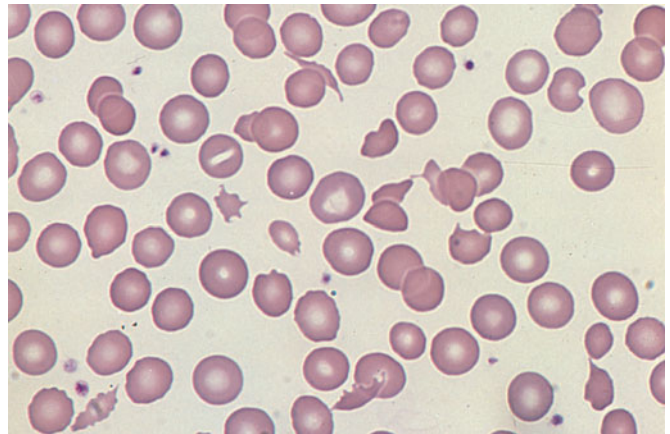
**Spherocytosis.** Note small hyperchromatic cells without the usual clear area in the center.

**FIGURE 6-9**

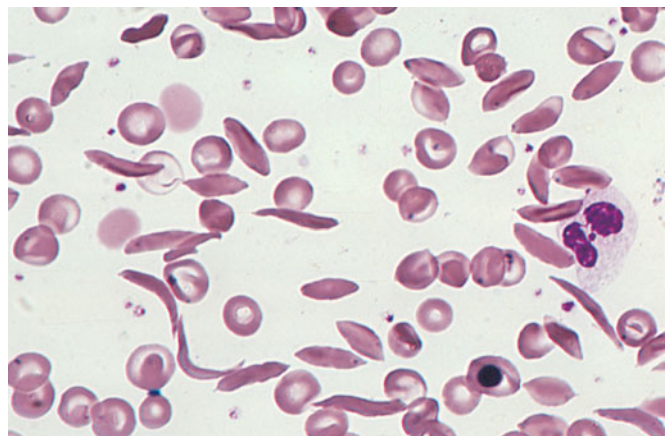
**Rouleaux formation.** Small lymphocyte in center of field. These red cells align themselves in stacks and are related to increased serum protein levels.

**FIGURE 6-10**

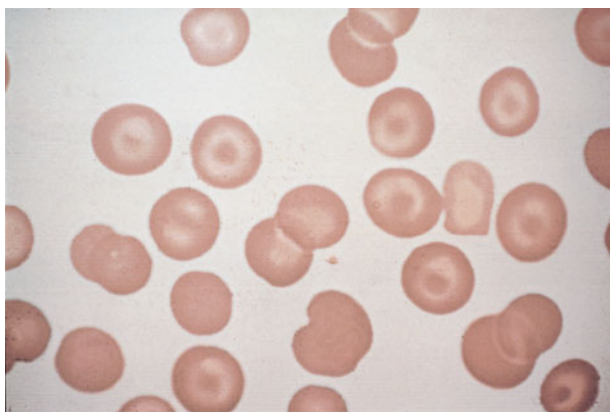
**Red cell agglutination.** Small lymphocyte and segmented neutrophil upper left center. Note irregular collections of aggregated red cells.

**FIGURE 6-11**

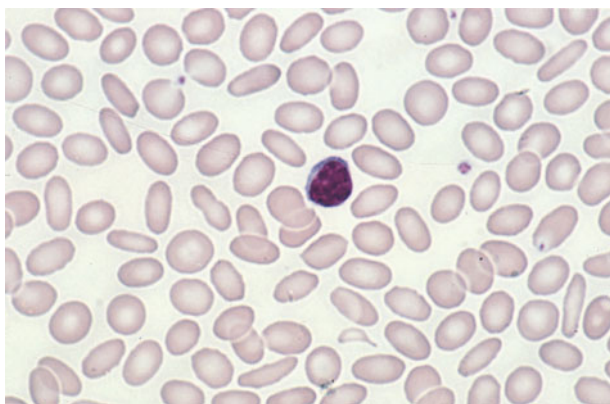
**Fragmented red cells.** Heart valve hemolysis.

**FIGURE 6-12**

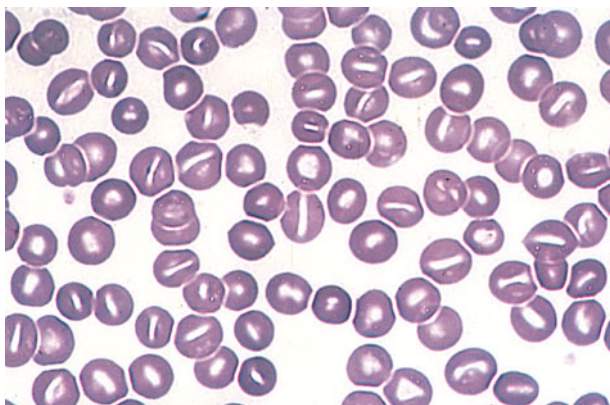
**Sickle cells.** Homozygous sickle cell disease. A nucleated red cell and neutrophil are also in the field.

**FIGURE 6-13**

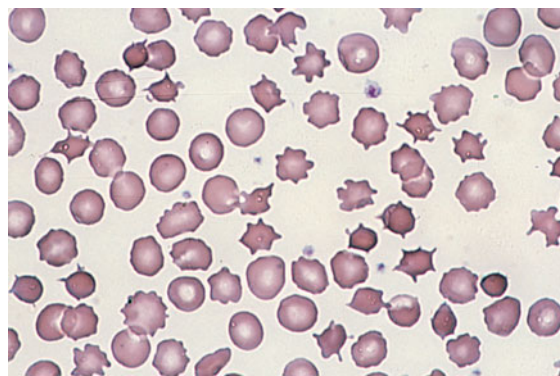
**Target cells.** Target cells are recognized by the bull's-eye appearance of the cell. Small numbers of target cells are seen with liver disease and thalassemia. Larger numbers are typical of hemoglobin C disease.

**FIGURE 6-14**

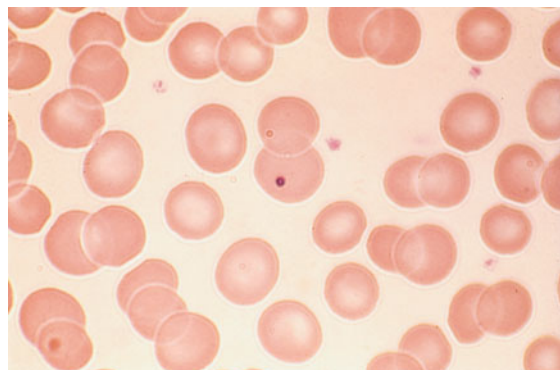
**Elliptocytosis.** Small lymphocyte in center of field. Elliptical shape of red cells related to weakened membrane structure, usually due to mutations in spectrin.

**FIGURE 6-15**

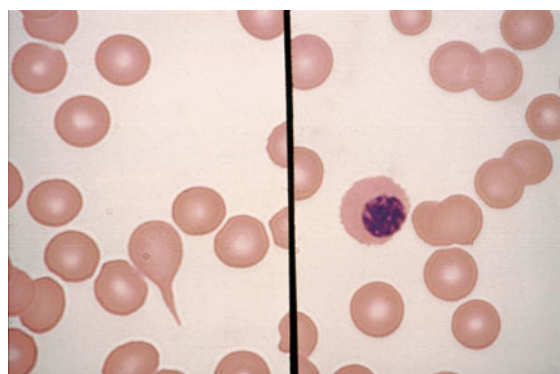
**Stomatocytosis.** Red cells characterized by a wide transverse slit or stoma. This is often seen as an artifact in a dehydrated blood smear. These cells can be seen in hemolytic anemias and in conditions in which the red cell is overhydrated or dehydrated.

**FIGURE 6-16**

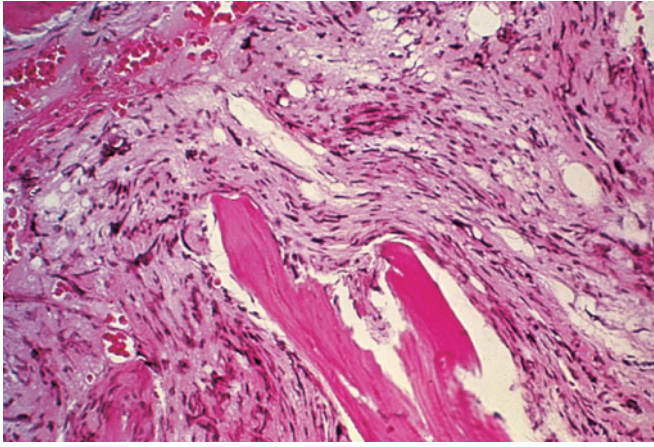
**Acanthocytosis.** Spiculated red cells are of two types: *acanthocytes* are contracted dense cells with irregular membrane projections that vary in length and width; *echinocytes* have small, uniform, and evenly spaced membrane projections. Acanthocytes are present in severe liver disease, in patients with abetalipoproteinemia, and in rare patients with McLeod blood group. Echinocytes are found in patients with severe uremia, in glycolytic red cell enzyme defects, and in microangiopathic hemolytic anemia.

**FIGURE 6-17**

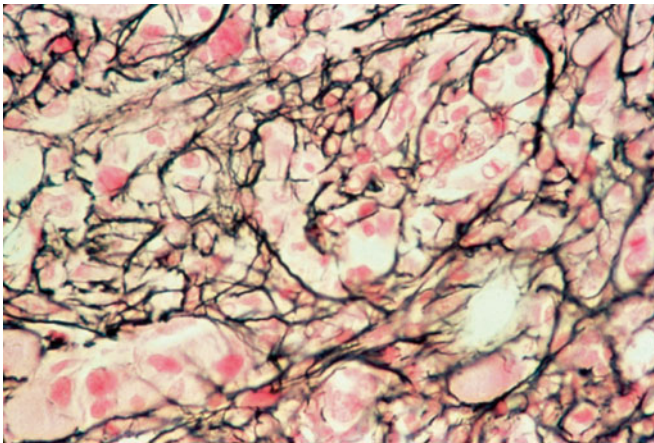
**Howell-Jolly bodies.** Howell-Jolly bodies are tiny nuclear remnants that are normally removed by the spleen. They appear in the blood after splenectomy (defect in removal) and with maturation/dysplastic disorders (excess production).

**FIGURE 6-18**

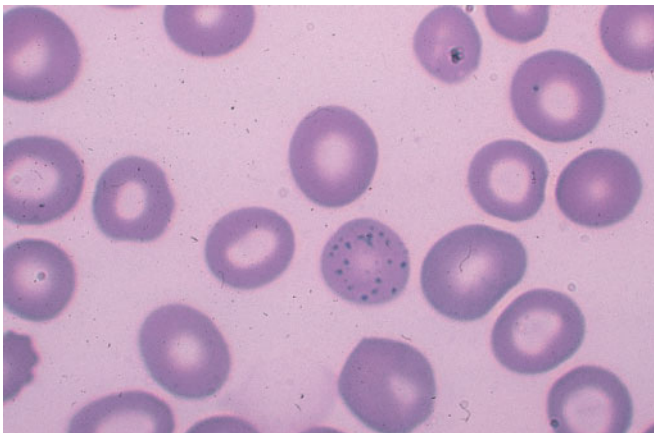
**Teardrop cells and nucleated red blood cells characteristic of myelofibrosis.** A teardrop-shaped red blood cell (*left panel*) and a nucleated red blood cell (*right panel*) as typically seen with myelofibrosis and extramedullary hematopoiesis.

**FIGURE 6-19**

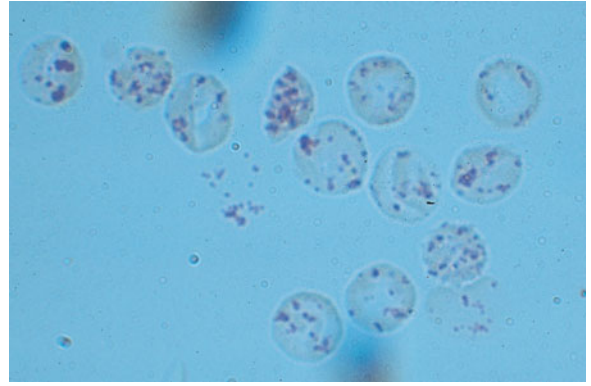
**Myelofibrosis of the bone marrow.** Total replacement of marrow precursors and fat cells by a dense infiltrate of reticulin fibers and collagen (H&E stain).

**FIGURE 6-20**

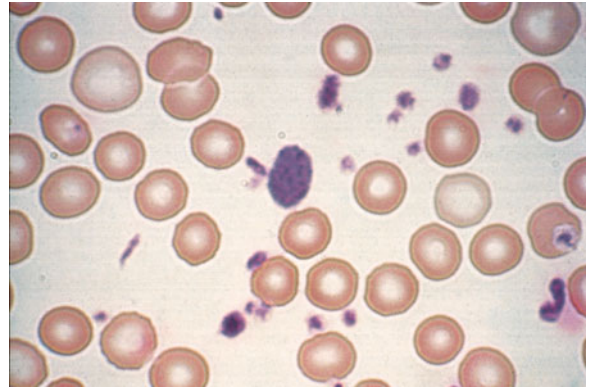
**Reticulin stain of marrow myelofibrosis.** Silver stain of a myelofibrotic marrow showing an increase in reticulin fibers (black-staining threads).

**FIGURE 6-21**

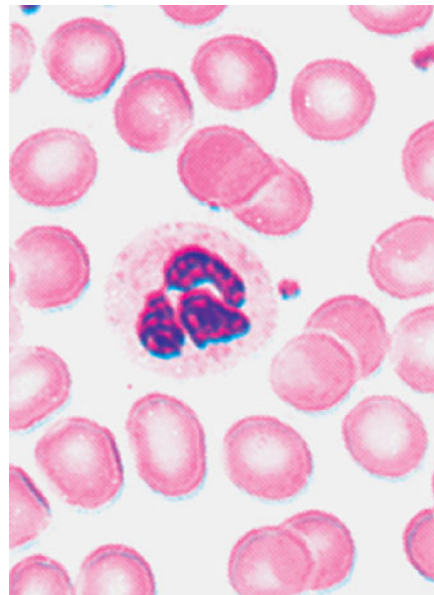
**Stippled red cell in lead poisoning.** Mild hypochromia. Coarsely stippled red cell.

**FIGURE 6-22**

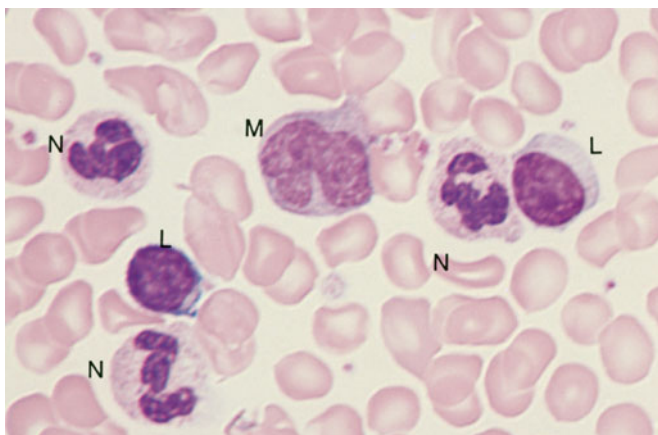
**Heinz bodies.** Blood mixed with hypotonic solution of crystal violet. The stained material is precipitates of denatured hemoglobin within cells.

**FIGURE 6-23**

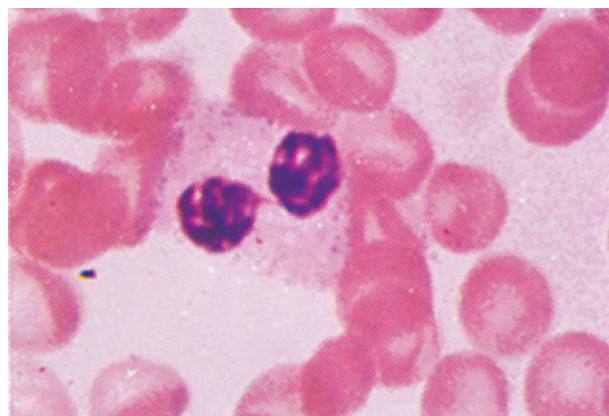
**Giant platelets.** Giant platelets, together with a marked increase in the platelet count, are seen in myeloproliferative disorders, especially primary thrombocythemia.

**FIGURE 6-24**

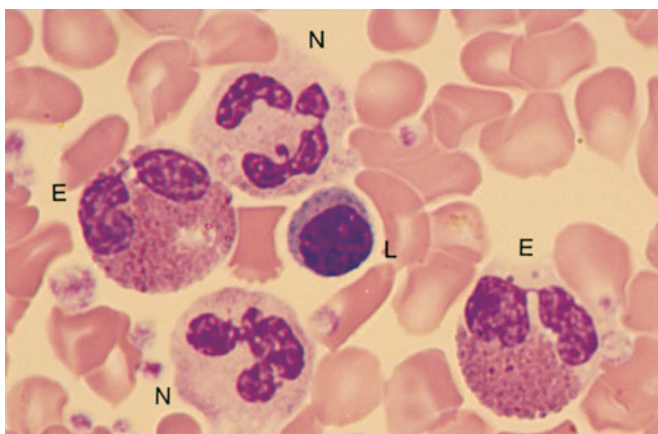
**Normal granulocytes.** The normal granulocyte has a segmented nucleus with heavy clumped chromatin; fine neutrophilic granules are dispersed throughout the cytoplasm.

**FIGURE 6-25**

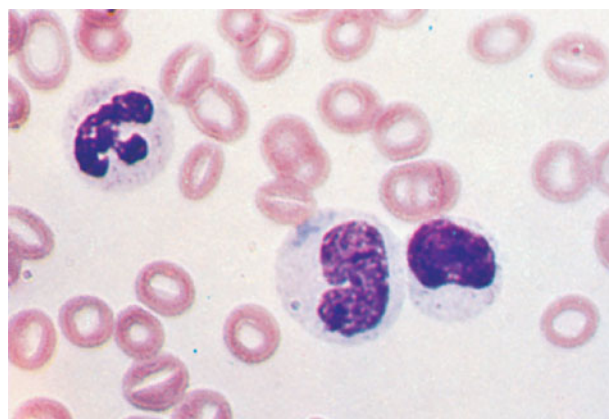
**Normal monocytes.** The film was prepared from the buffy coat of the blood from a normal donor. L, lymphocyte; M monocyte; N, neutrophil.

**FIGURE 6-28**

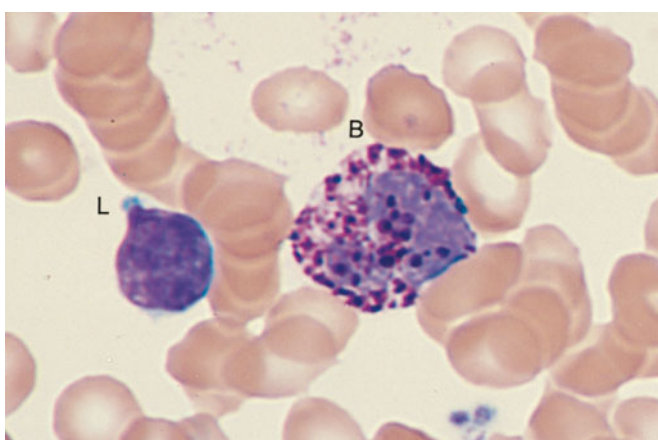
**Pelger-Huet anomaly.** In this benign disorder, most of the granulocytes are bilobed. The nucleus frequently has a spectacle-like, or "pince-nez" configuration.

**FIGURE 6-26**

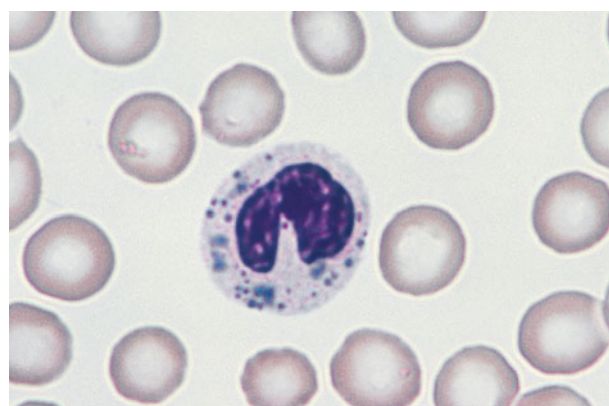
**Normal eosinophils.** The film was prepared from the buffy coat of the blood from a normal donor. N, neutrophil; E, eosinophil.

**FIGURE 6-29**

**Döhle body.** Neutrophil band with Döhle body. The neutrophil with a sausage-shaped nucleus in the center of the field is a band form. Döhle bodies are discrete, blue-staining nongranular areas found in the periphery of the cytoplasm of the neutrophil in infections and other toxic states. They represent aggregates of rough endoplasmic reticulum.

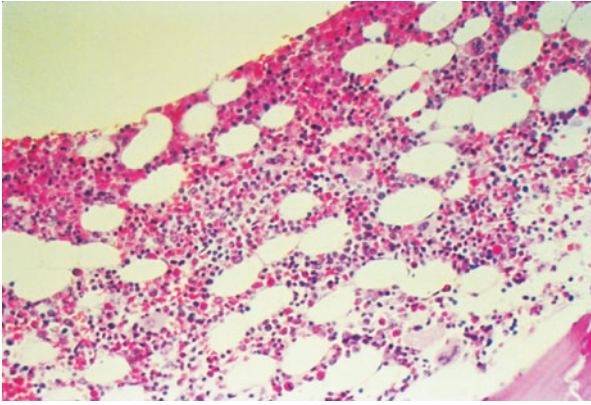
**FIGURE 6-27**

**Normal basophil.** The film was prepared from the buffy coat of the blood from a normal donor. L, lymphocyte; B, basophil.

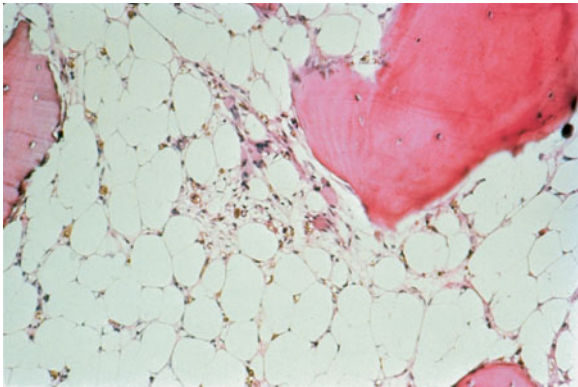
**FIGURE 6-30**

**Chédiak-Higashi disease.** Note giant granules in neutrophil.

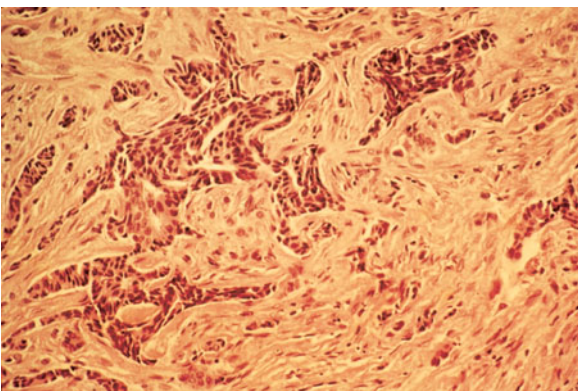


**FIGURE 6-31**

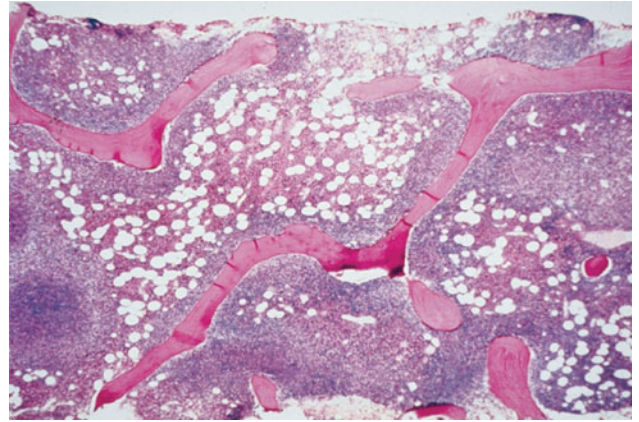
**Normal bone marrow.** Low-power view of normal adult marrow (H&E stain), showing a mix of fat cells (clear areas) and hematopoietic cells. The percentage of the space that is hematopoietic cells is referred to as *marrow cellularity*. In adults, normal marrow cellularity is 35–40%. If demands for increased marrow production occur, cellularity may increase to meet the demand. As we age, the marrow cellularity decreases and the marrow fat increases. Patients >70 years of age may have a 20–30% marrow cellularity.

**FIGURE 6-32**

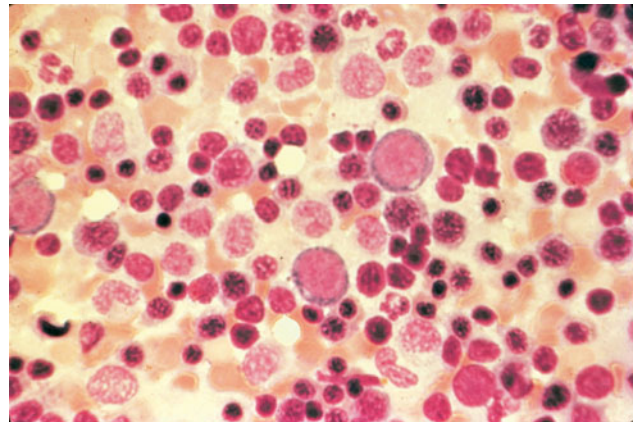
**Aplastic anemia bone marrow.** Normal hematopoietic precursor cells are virtually absent, leaving behind fat cells, reticuloendothelial cells, and the underlying sinusoidal structure.

**FIGURE 6-33**

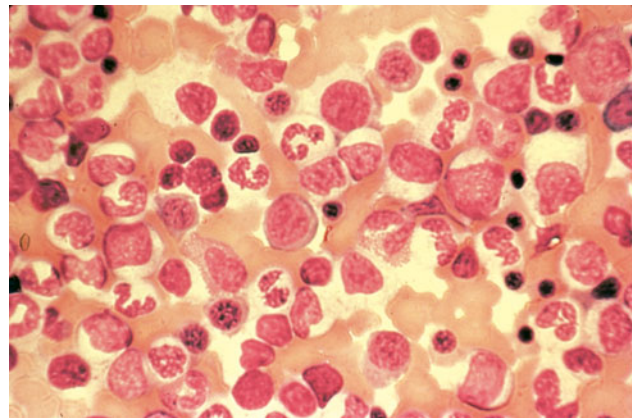
**Metastatic cancer in the bone marrow.** Marrow biopsy specimen infiltrated with metastatic breast cancer and reactive fibrosis (H&E stain).

**FIGURE 6-34**

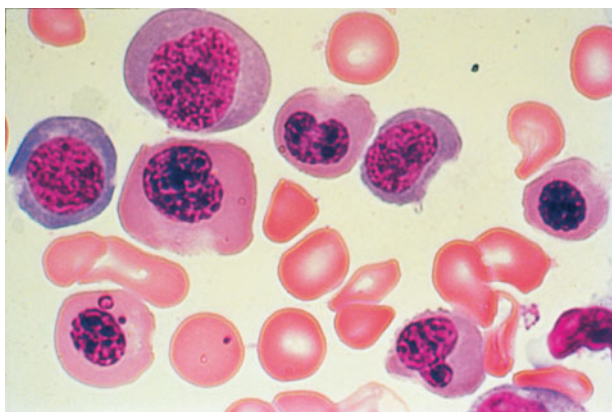
**Lymphoma in the bone marrow.** Nodular (follicular) lymphoma infiltrate in a marrow biopsy specimen. Note the characteristic paratrabecular location of the lymphoma cells.

**FIGURE 6-35**

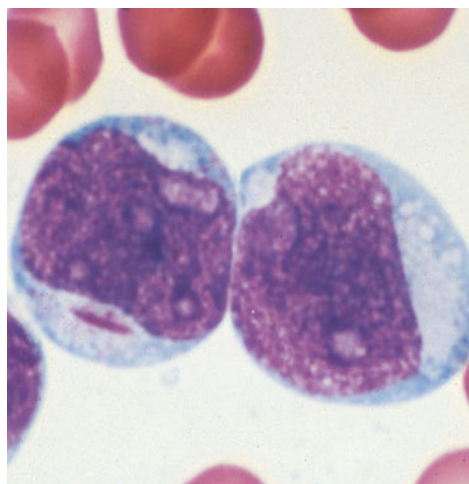
**Erythroid hyperplasia of the marrow.** Marrow aspirate specimen with a myeloid/erythroid ratio (M/E ratio) of 1:1–2, typical for a patient with a hemolytic anemia or recovering from blood loss.

**FIGURE 6-36**

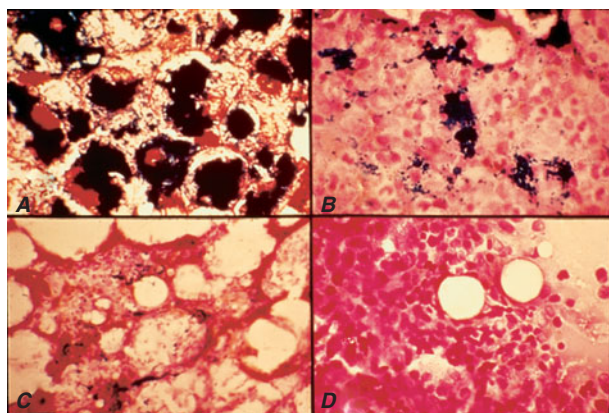
**Myeloid hyperplasia of the marrow.** Marrow aspirate specimen showing a myeloid/erythroid ratio of  $\geq 3:1$ , suggesting either a loss of red blood cell precursors or an expansion of myeloid elements.

**FIGURE 6-37**

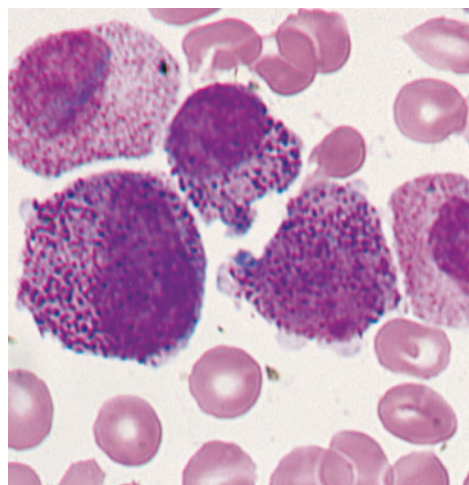
**Megaloblastic erythropoiesis.** High-power view of megaloblastic red blood cell precursors from a patient with a macrocytic anemia. Maturation is delayed with late normoblasts showing a more immature-appearing nucleus with a lattice-like pattern with normal cytoplasmic maturation.

**FIGURE 6-40**

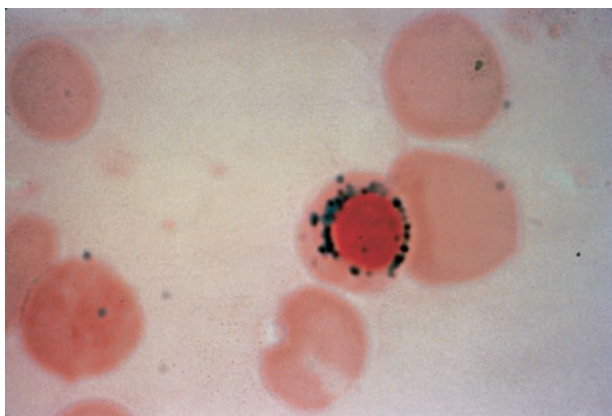
**Acute myeloid leukemia.** Leukemic myeloblast with an Auer rod. Note two to four large, prominent nucleoli in each cell.

**FIGURE 6-38**

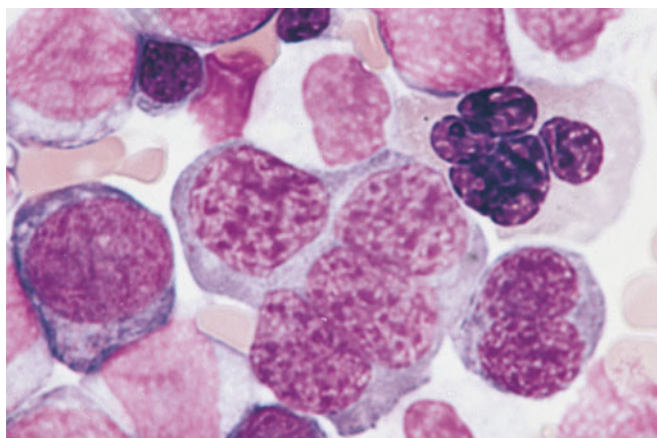
**Prussian blue staining of marrow iron stores.** Iron stores can be graded on a scale of 0-4+. **A:** a marrow with excess iron stores (>4+); **B:** normal stores (2-3+); **C:** minimal stores (1+); and **D:** absent iron stores (0).

**FIGURE 6-41**

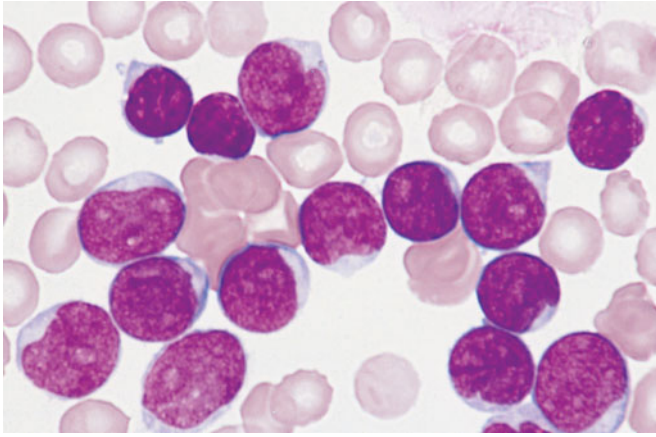
**Acute promyelocytic leukemia.** Note prominent cytoplasmic granules in the leukemia cells.

**FIGURE 6-39**

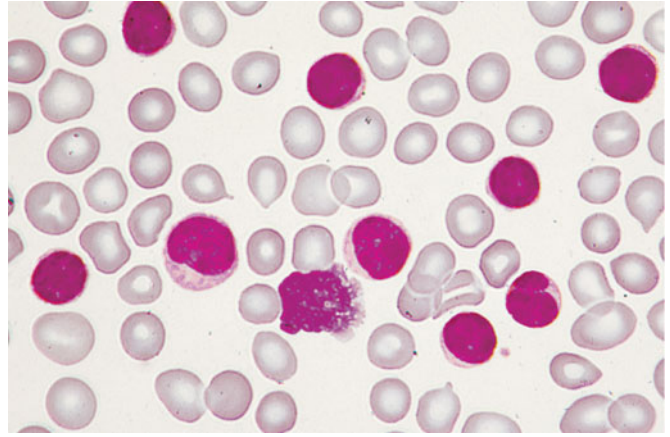
**Ringed sideroblast.** An orthochromatic normoblast with a collar of blue granules (mitochondria encrusted with iron) surrounding the nucleus.

**FIGURE 6-42**

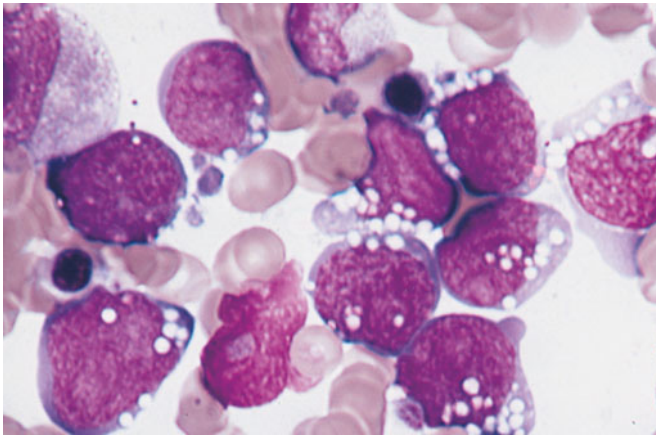
**Acute erythroleukemia.** Note giant dysmorphic erythroblasts; two are binucleate and one is multinucleate.



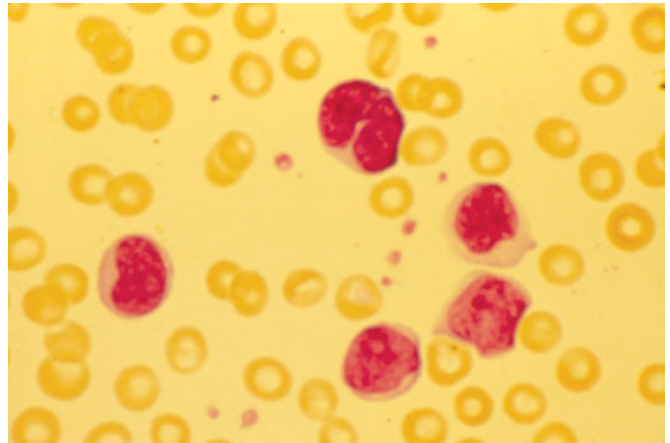
**FIGURE 6-43**  
Acute lymphoblastic leukemia.



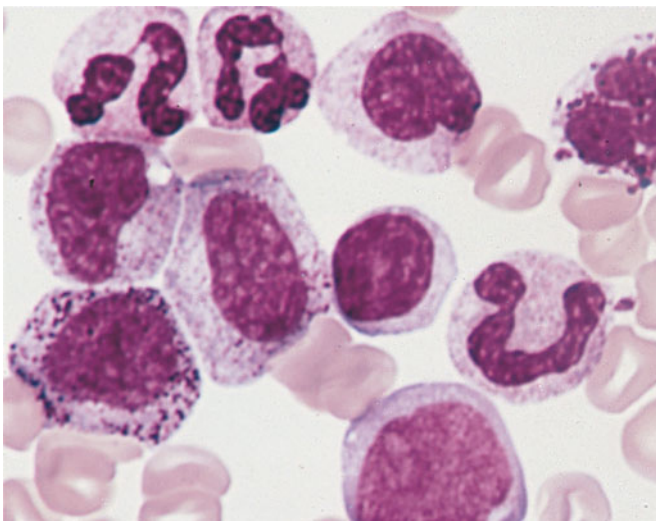
**FIGURE 6-46**  
Chronic lymphoid leukemia in the peripheral blood.



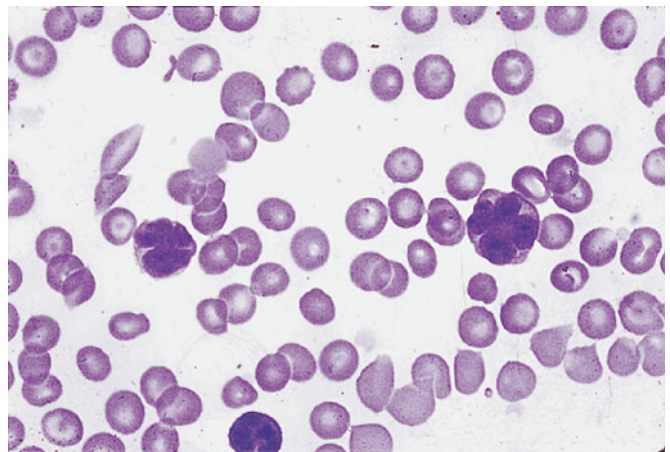
**FIGURE 6-44**  
Burkitt's leukemia, acute lymphoblastic leukemia.



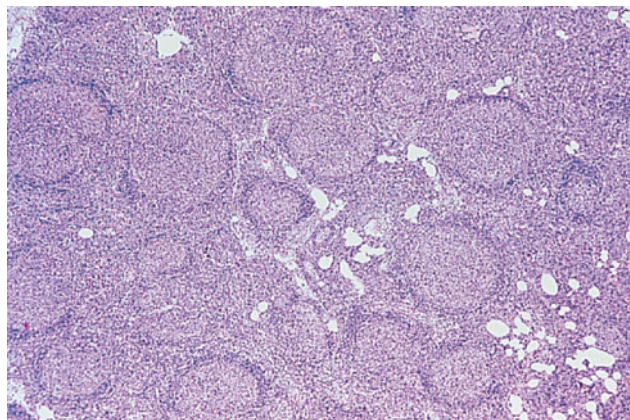
**FIGURE 6-47**  
**Sézary's syndrome.** Lymphocytes with frequently convoluted nuclei (Sézary cells) in a patient with advanced mycosis fungoides.



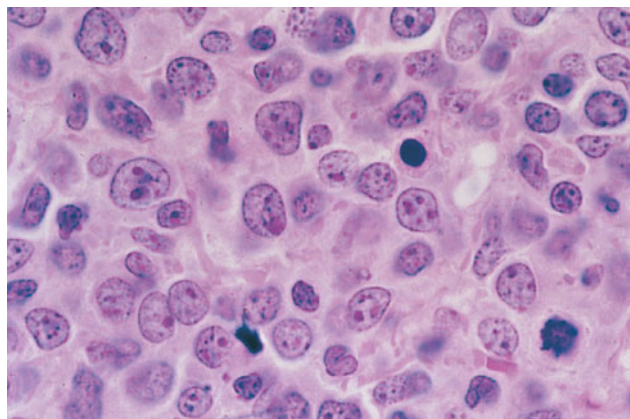
**FIGURE 6-45**  
Chronic myeloid leukemia in the peripheral blood.



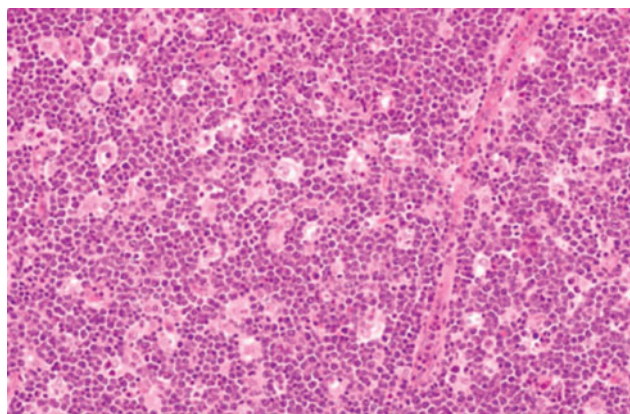
**FIGURE 6-48**  
**Adult T cell leukemia.** Peripheral blood smear showing leukemia cells with typical "flower-shaped" nucleus.

**FIGURE 6-49**

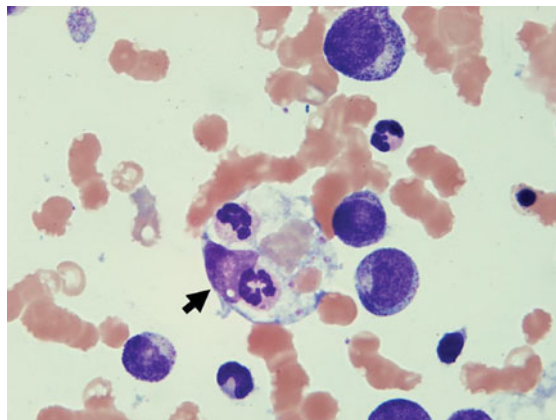
**Follicular lymphoma in a lymph node.** The normal nodal architecture is effaced by nodular expansions of tumor cells. Nodules vary in size and contain predominantly small lymphocytes with cleaved nuclei along with variable numbers of larger cells with vesicular chromatin and prominent nucleoli.

**FIGURE 6-50**

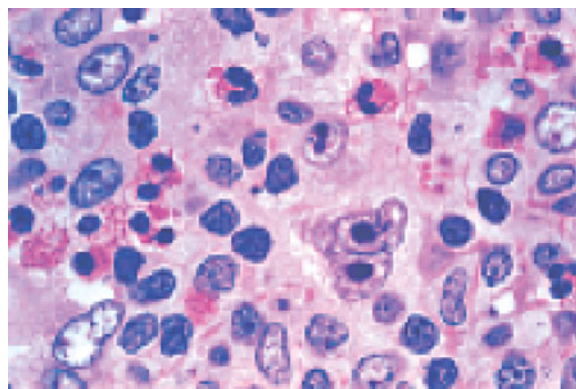
**Diffuse large B cell lymphoma in a lymph node.** The neoplastic cells are heterogeneous but predominantly large cells with vesicular chromatin and prominent nucleoli.

**FIGURE 6-51**

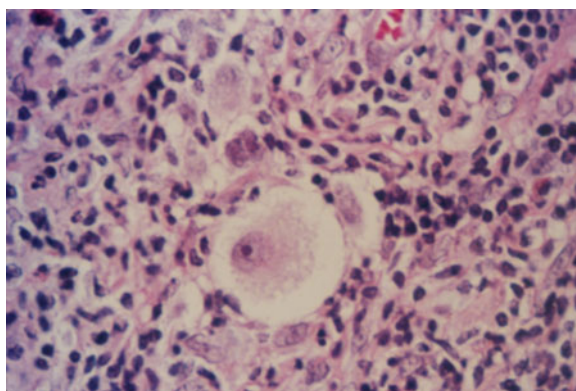
**Burkitt's lymphoma in a lymph node.** Burkitt's lymphoma with starry-sky appearance. The lighter areas are macrophages attempting to clear dead cells.

**FIGURE 6-52**

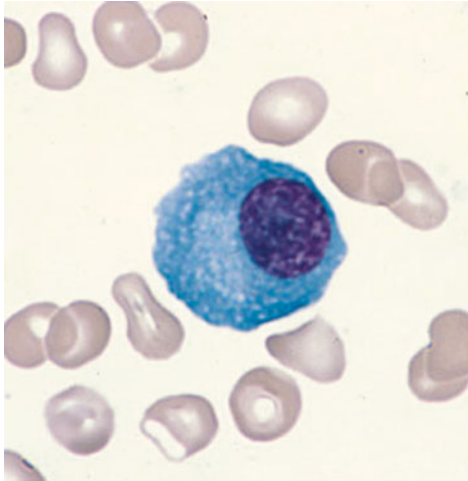
**Erythrophagocytosis accompanying aggressive lymphoma.** The central macrophage is ingesting red cells, neutrophils, and platelets. (Courtesy of Dr. Kiyomi Tsukimori, Kyushu University, Fukuoka, Japan.)

**FIGURE 6-53**

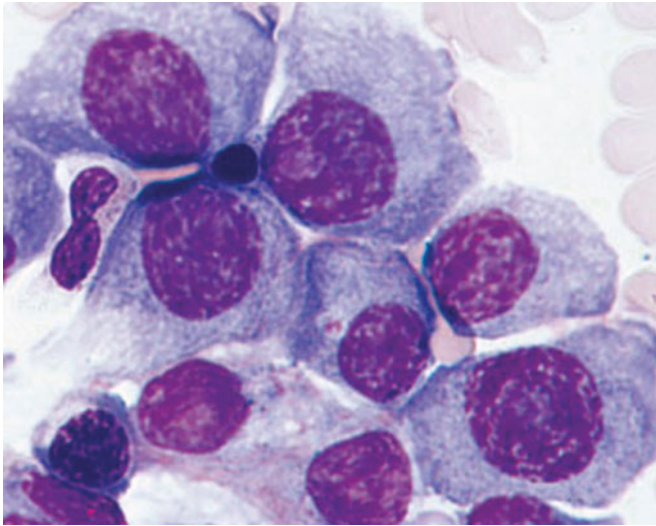
**Hodgkin's disease.** A Reed-Sternberg cell is present near the center of the field; a large cell with a bilobed nucleus and prominent nucleoli giving an "owl's eyes" appearance. Most of the cells are normal lymphocytes, neutrophils, and eosinophils that form a pleomorphic cellular infiltrate.

**FIGURE 6-54**

**Lacunar cell; Reed-Sternberg cell variant in nodular sclerosing Hodgkin's disease.** High-power view of single mononuclear lacunar cell with retracted cytoplasm in a patient with nodular sclerosing Hodgkin's disease.



**FIGURE 6-55**  
Normal plasma cell.



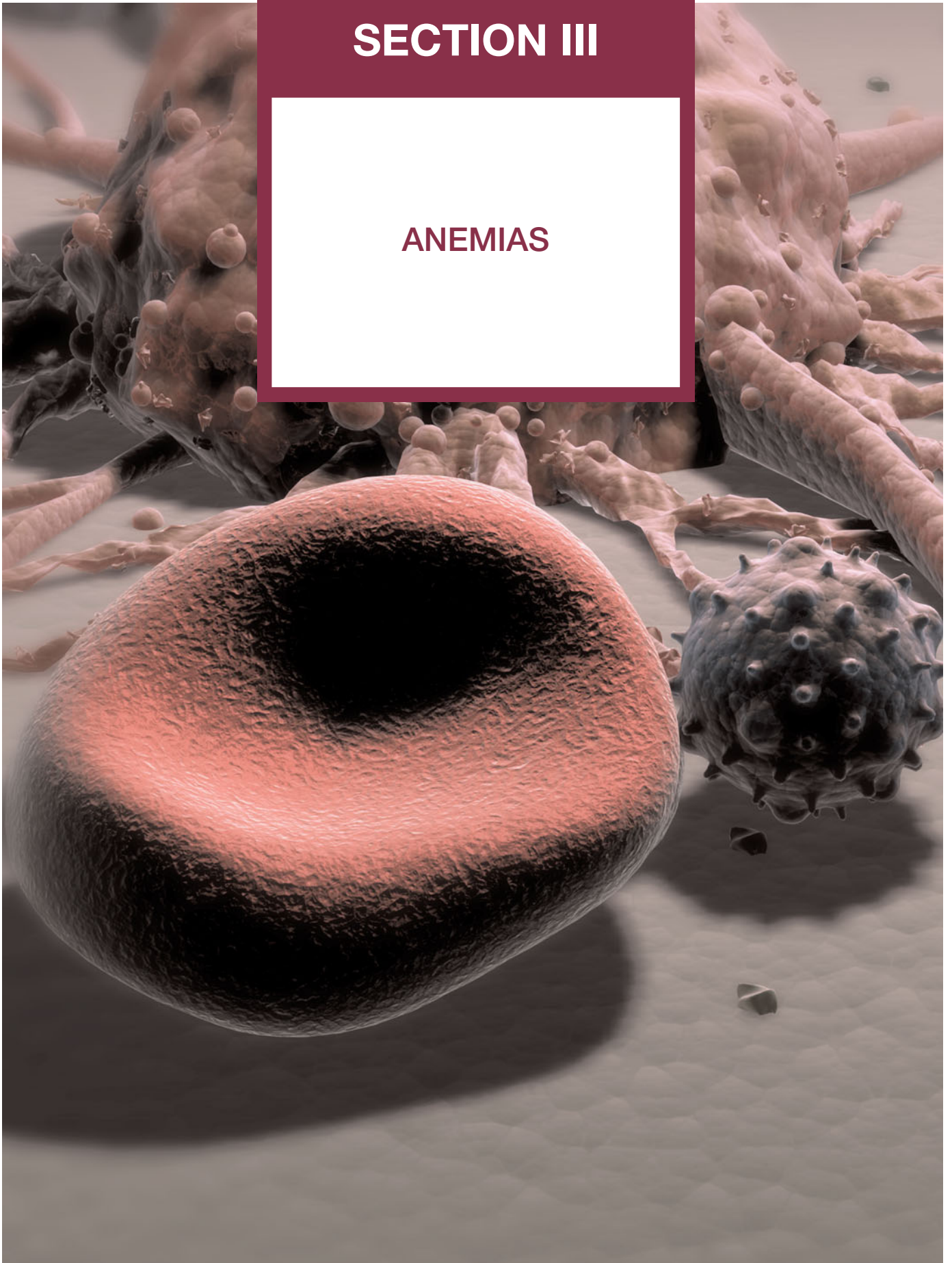
**FIGURE 6-56**  
Multiple myeloma.

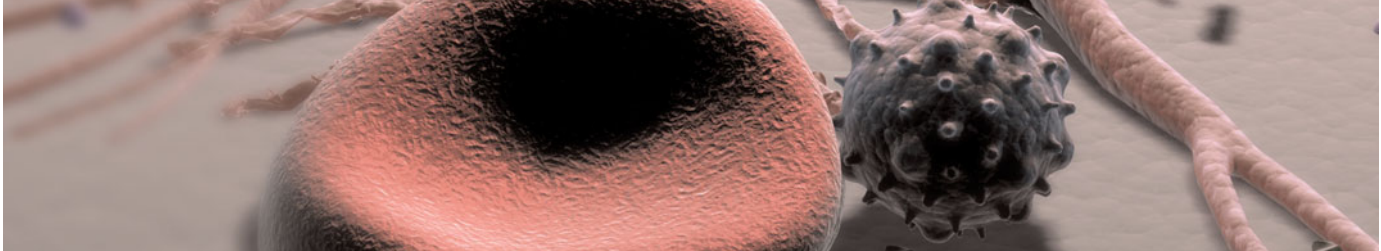


**FIGURE 6-57**  
**Color serum in hemoglobinemia.** The distinctive red coloration of plasma (hemoglobinemia) in a spun blood sample in a patient with intravascular hemolysis.

# SECTION III

## ANEMIAS





## CHAPTER 7

# IRON DEFICIENCY AND OTHER HYPOPROLIFERATIVE ANEMIAS

John W. Adamson

■ Iron Metabolism . . . . .	70	Differential Diagnosis . . . . .	75
The Iron Cycle in Humans . . . . .	71	■ Other Hypoproliferative Anemias . . . . .	77
Nutritional Iron Balance . . . . .	72	Anemia of Acute and Chronic Inflammation/Infection (The Anemia of Chronic Disease) . . . . .	77
Iron-Deficiency Anemia . . . . .	73	Anemia of Renal Disease . . . . .	78
Stages of Iron Deficiency . . . . .	73	Anemia in Hypometabolic States . . . . .	79
Causes of Iron Deficiency . . . . .	73	■ Further Readings . . . . .	80
Clinical Presentation of Iron Deficiency . . . . .	73		
Laboratory Iron Studies . . . . .	74		

Anemias associated with normocytic and normochromic red cells and an inappropriately low reticulocyte response (reticulocyte index <2.0–2.5) are *hypoproliferative anemias*. This category includes early iron deficiency (before hypochromic microcytic red cells develop), acute and chronic inflammation (including many malignancies), renal disease, hypometabolic states such as protein malnutrition and endocrine deficiencies, and anemias from marrow damage. Marrow damage states are discussed in Chap. 11.

Hypoproliferative anemias are the most common anemias, and anemia associated with acute and chronic inflammation is the most common of these. The anemia of inflammation, like iron deficiency, is related in part to abnormal iron metabolism. The anemias associated with renal disease, inflammation, cancer, and hypometabolic states are characterized by an abnormal erythropoietin response to the anemia.

### IRON METABOLISM

Iron is a critical element in the function of all cells, although the amount of iron required by individual tissues varies during development. At the same time, the body must protect itself from free iron, which is highly toxic in that it participates in chemical reactions that

generate free radicals such as singlet  $O_2$  or  $OH^-$ . Consequently, elaborate mechanisms have evolved that allow iron to be made available for physiologic functions while at the same time conserving this element and handling it in such a way that toxicity is avoided.

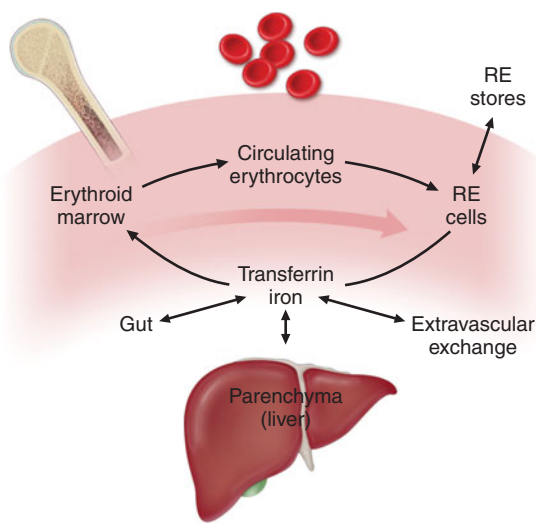
The major role of iron in mammals is to carry  $O_2$  as part of hemoglobin.  $O_2$  is also bound by myoglobin in muscle. Iron is a critical element in iron-containing enzymes, including the cytochrome system in mitochondria. Iron distribution in the body is shown in [Table 7-1](#). Without iron, cells lose their capacity for electron transport and energy metabolism. In erythroid cells, hemoglobin synthesis is impaired, resulting in anemia and reduced  $O_2$  delivery to tissue.

**TABLE 7-1**  
**BODY IRON DISTRIBUTION**

	IRON CONTENT, mg	
	ADULT MALE, 80 kg	ADULT FEMALE, 60 kg
Hemoglobin	2500	1700
Myoglobin/enzymes	500	300
Transferrin iron	3	3
Iron stores	600–1000	0–300

## THE IRON CYCLE IN HUMANS

**Figure 7-1** outlines the major pathways of internal iron exchange in humans. Iron absorbed from the diet or released from stores circulates in the plasma bound to *transferrin*, the iron transport protein. Transferrin is a bilobed glycoprotein with two iron binding sites. Transferrin that carries iron exists in two forms—*monoferric* (one iron atom) or *diferric* (two iron atoms). The turnover (half-clearance time) of transferrin-bound iron is very rapid—typically 60–90 minutes. Because almost all of the iron transported by transferrin is delivered to the erythroid marrow, the clearance time of transferrin-bound iron from the circulation is affected most by the plasma iron level and the erythroid marrow activity. When erythropoiesis is markedly stimulated, the pool of erythroid cells requiring iron increases and the clearance time of iron from the circulation decreases. The half-clearance time of iron in the presence of iron deficiency is as short as 10–15 minutes. With suppression of erythropoiesis, the plasma iron level typically increases and the half-clearance time may be prolonged to several hours. Normally, the iron bound to transferrin turns over 10–20 times per day. Assuming a normal plasma iron level of 80–100  $\mu\text{g}/\text{dL}$ , the amount of iron passing through the transferrin pool is 20–24 mg/d.



**FIGURE 7-1**

**Internal iron exchange.** Normally about 80% of iron passing through the plasma transferrin pool is recycled from broken-down red cells. Absorption of about 1 mg/d is required from the diet in men, 1.4 mg/d in women to maintain homeostasis. As long as transferrin saturation is maintained between 20 and 60% and erythropoiesis is not increased, iron stores are not required. However, in the event of blood loss, dietary iron deficiency, or inadequate iron absorption, up to 40 mg/d of iron can be mobilized from stores. RE, reticuloendothelial.

The iron-transferrin complex circulates in the plasma until it interacts with specific *transferrin receptors* on the surface of marrow erythroid cells. Diferric transferrin has the highest affinity for transferrin receptors; apo-transferrin (transferrin not carrying iron) has very little affinity. Although transferrin receptors are found on cells in many tissues within the body—and all cells at some time during development will display transferrin receptors—the cell having the greatest number of receptors (300,000 to 400,000/cell) is the developing erythroblast.

Once the iron-bearing transferrin interacts with its receptor, the complex is internalized via clathrin-coated pits and transported to an acidic endosome, where the iron is released at the low pH. The iron is then made available for heme synthesis while the transferrin-receptor complex is recycled to the surface of the cell, where the bulk of the transferrin is released back into circulation and the transferrin receptor re-anchors into the cell membrane. At this point a certain amount of the transferrin receptor protein may be released into circulation and can be measured as soluble transferrin receptor protein. Within the erythroid cell, iron in excess of the amount needed for hemoglobin synthesis binds to a storage protein, *apoferritin*, forming *ferritin*. This mechanism of iron exchange also takes place in other cells of the body expressing transferrin receptors, especially liver parenchymal cells where the iron can be incorporated into heme-containing enzymes or stored. The iron incorporated into hemoglobin subsequently enters the circulation as new red cells are released from the bone marrow. The iron is then part of the red cell mass and will not become available for reutilization until the red cell dies.

In a normal individual, the average red cell life span is 120 days. Thus 0.8–1.0% of red cells turn over each day. At the end of its life span, the red cell is recognized as senescent by the cells of the *reticuloendothelial (RE) system*, and the cell undergoes phagocytosis. Once within the RE cell, the hemoglobin from the ingested red cell is broken down, the globin and other proteins are returned to the amino acid pool, and the iron is shuttled back to the surface of the RE cell, where it is presented to circulating transferrin. It is the efficient and highly conserved recycling of iron from senescent red cells that supports steady-state (and even mildly accelerated) erythropoiesis.

Because each milliliter of red cells contains 1 mg of elemental iron, the amount of iron needed to replace those red cells lost through senescence amounts to 16–20 mg/d (assuming an adult with a red cell mass of 2 L). Any additional iron required for daily red cell production comes from the diet. Normally, an adult man needs to absorb at least 1 mg of elemental iron daily to meet needs; women females in the childbearing years need to absorb an average of 1.4 mg/d. However, to achieve a maximum proliferative erythroid marrow



72 response to anemia, additional iron must be available. With markedly stimulated erythropoiesis, demands for iron are increased by as much as six- to eightfold. With extravascular hemolytic anemia, the rate of red cell destruction is increased, but the iron recovered from the red cells is efficiently reutilized for hemoglobin synthesis. In contrast, with intravascular hemolysis or blood loss anemia, the rate of red cell production is limited by the amount of iron that can be mobilized from stores. Typically, the rate of mobilization under these circumstances will not support red cell production more than 2.5 times normal. If the delivery of iron to the stimulated marrow is suboptimal, the marrow's proliferative response is blunted, and hemoglobin synthesis is impaired. The result is a hypoproliferative marrow accompanied by microcytic, hypochromic anemia.

Whereas blood loss or hemolysis places a demand on the iron supply, conditions associated with inflammation interfere with iron release from stores and can result in a rapid decrease in the serum iron (see later).

### NUTRITIONAL IRON BALANCE

The balance of iron in humans is tightly controlled and designed to conserve iron for reutilization. There is no regulated excretory pathway for iron, and the only mechanisms by which iron is lost from the body are blood loss (via gastrointestinal bleeding, menses, or other forms of bleeding) and the loss of epithelial cells from the skin, gut, and genitourinary tract. Normally, the only route by which iron comes into the body is via absorption from food or from medicinal iron taken orally. Iron may also enter the body through red cell transfusions or injection of iron complexes. The margin between the amount of iron available for absorption and the requirement for iron in growing infants and the adult woman is narrow; this accounts for the great prevalence of iron deficiency worldwide—currently estimated at half a billion people.

The amount of iron required from the diet to replace losses averages ~10% of body iron content a year in men and 15% in women of childbearing age. Dietary iron content is closely related to total caloric intake (approximately 6 mg of elemental iron/1000 calories). Iron bioavailability is affected by the nature of the foodstuff, with heme iron (e.g., red meat) being most readily absorbed. In the United States, the average iron intake in an adult man is 15 mg/d with 6% absorption; for the average woman, the daily intake is 11 mg/d with 12% absorption. An individual with iron deficiency can increase iron absorption to ~20% of the iron present in a meat-containing diet but only 5–10% of the iron in a vegetarian diet. As a result, a third of the female population in the United States has virtually no iron stores. Vegetarians are at an additional disadvantage because certain foodstuffs that include phytates and phosphates

reduce iron absorption by ~50%. When ionizable iron salts are given together with food, the amount of iron absorbed is reduced. When the percentage of iron absorbed from individual food items is compared with the percentage for an equivalent amount of ferrous salt, iron in vegetables is only about a twentieth as available, egg iron an eighth, liver iron a half, and heme iron one-half to two-thirds.

Infants, children, and adolescents may be unable to maintain normal iron balance because of the demands of body growth and lower dietary intake of iron. During the last two trimesters of pregnancy, daily iron requirements increase to 5–6 mg. That is the reason why iron supplements are strongly recommended for pregnant women in developed countries. Enthusiasm for supplementing foods such as bread and cereals with iron has waned in the face of concerns that the very prevalent hemochromatosis gene would result in an unacceptable risk of iron overload.

Iron absorption takes place largely in the proximal small intestine and is a carefully regulated process. For absorption, iron must be taken up by the luminal cell. That process is facilitated by the acidic contents of the stomach, which maintains the iron in solution. At the brush border of the absorptive cell, the ferric iron is converted to the ferrous form by a ferrireductase. Transport across the membrane is accomplished by divalent metal transporter 1 (DMT-1, also known as Nramp 2 or DCT-1). DMT-1 is a general cation transporter. Once inside the gut cell, iron may be stored as ferritin or transported through the cell to be released at the basolateral surface to plasma transferrin through the membrane-embedded iron exporter, ferroportin. The function of ferroportin is negatively regulated by hepcidin, the principal iron regulatory hormone. In the process of release, iron interacts with another ferroxidase, hephaestin, which oxidizes the iron to the ferric form for transferrin binding. Hephaestin is similar to ceruloplasmin, the copper-carrying protein.

Iron absorption is influenced by a number of physiologic states. Erythroid hyperplasia, for example, stimulates iron absorption, even in the face of normal or increased iron stores, and hepcidin levels are inappropriately low. The molecular mechanism underlying this relationship is not known. Thus patients with anemias associated with high levels of ineffective erythropoiesis absorb excess amounts of dietary iron. Over time, this may lead to iron overload and tissue damage. In iron deficiency, hepcidin levels are low and iron is much more efficiently absorbed from a given diet; the contrary is true in states of secondary iron overload. The normal individual can reduce iron absorption in situations of excessive intake or medicinal iron intake; however, while the percentage of iron absorbed goes down, the absolute amount goes up. This accounts for the acute iron toxicity occasionally seen when children ingest large numbers of

iron tablets. Under these circumstances, the amount of iron absorbed exceeds the transferrin binding capacity of the plasma, resulting in free iron that affects critical organs such as cardiac muscle cells.

## IRON-DEFICIENCY ANEMIA



Iron deficiency is one of the most prevalent forms of malnutrition. Globally, 50% of anemia is attributable to iron deficiency and accounts for ~841,000 deaths annually worldwide. Africa and parts of Asia bear 71% of the global mortality burden; North America represents only 1.4% of the total morbidity and mortality associated with iron deficiency.

### STAGES OF IRON DEFICIENCY

Iron-deficiency anemia is the condition in which there is anemia and clear evidence of iron lack. The progression to iron deficiency can be divided into three stages (Fig. 7-2). The first stage is *negative iron balance*, in which the demands for (or losses of) iron exceed the body's ability to absorb iron from the diet. This stage

results from a number of physiologic mechanisms, including blood loss, pregnancy (in which the demands for red cell production by the fetus outstrip the mother's ability to provide iron), rapid growth spurts in the adolescent, or inadequate dietary iron intake. Blood loss in excess of 10–20 mL of red cells per day is greater than the amount of iron that the gut can absorb from a normal diet. Under these circumstances the iron deficit must be made up by mobilization of iron from RE storage sites. During this period, iron stores—reflected by the serum ferritin level or the appearance of stainable iron on bone marrow aspirations—decrease. As long as iron stores are present and can be mobilized, the serum iron, total iron-binding capacity (TIBC), and red cell protoporphyrin levels remain within normal limits. At this stage, red cell morphology and indices are normal.

When iron stores become depleted, the serum iron begins to fall. Gradually, the TIBC increases, as do red cell protoporphyrin levels. By definition, marrow iron stores are absent when the serum ferritin level is  $<15 \mu\text{g/L}$ . As long as the serum iron remains within the normal range, hemoglobin synthesis is unaffected despite the dwindling iron stores. Once the transferrin saturation falls to 15–20%, hemoglobin synthesis becomes impaired. This is a period of *iron-deficient erythropoiesis*. Careful evaluation of the peripheral blood smear reveals the first appearance of microcytic cells, and if the laboratory technology is available, one finds hypochromic reticulocytes in circulation. Gradually, the hemoglobin and hematocrit begin to fall, reflecting *iron-deficiency anemia*. The transferrin saturation at this point is 10–15%.

When moderate anemia is present (hemoglobin 10–13 g/dL), the bone marrow remains hypoproliferative. With more severe anemia (hemoglobin 7–8 g/dL), hypochromia and microcytosis become more prominent, target cells and misshapen red cells (poikilocytes) appear on the blood smear as cigar- or pencil-shaped forms, and the erythroid marrow becomes increasingly ineffective. Consequently, with severe prolonged iron-deficiency anemia, erythroid hyperplasia of the marrow develops, rather than hypoproliferation.

### CAUSES OF IRON DEFICIENCY

Conditions that increase demand for iron, increase iron loss, or decrease iron intake or absorption can produce iron deficiency (Table 7-2).

### CLINICAL PRESENTATION OF IRON DEFICIENCY

Certain clinical conditions carry an increased likelihood of iron deficiency. Pregnancy, adolescence, periods of rapid growth, and an intermittent history of blood loss of any kind should alert the clinician to possible iron deficiency. A cardinal rule is that the appearance of iron

	Normal	Negative iron balance	Iron-deficient erythropoiesis	Iron-deficiency anemia
Iron stores				
Erythron iron				
Marrow iron stores	1-3+	0-1+	0	0
Serum ferritin ( $\mu\text{g/L}$ )	50-200	$<20$	$<15$	$<15$
TIBC ( $\mu\text{g/dL}$ )	300-360	$>360$	$>380$	$>400$
SI ( $\mu\text{g/dL}$ )	50-150	NL	$<50$	$<30$
Saturation (%)	30-50	NL	$<20$	$<10$
Marrow sideroblasts (%)	40-60	NL	$<10$	$<10$
RBC protoporphyrin ( $\mu\text{g/dL}$ )	30-50	NL	$>100$	$>200$
RBC morphology	NL	NL	NL	Microcytic/hypochromic

**FIGURE 7-2**

**Laboratory studies in the evolution of iron deficiency.** Measurements of marrow iron stores, serum ferritin, and total iron-binding capacity (TIBC) are sensitive to early iron-store depletion. Iron-deficient erythropoiesis is recognized from additional abnormalities in the serum iron (SI), percent transferrin saturation, the pattern of marrow sideroblasts, and the red cell protoporphyrin level. Patients with iron-deficiency anemia demonstrate all the same abnormalities plus hypochromic microcytic anemia. (From Hillman and Finch, with permission.)

**CAUSES OF IRON DEFICIENCY**

Increased demand for iron and/or hematopoiesis
Rapid growth in infancy or adolescence
Pregnancy
Erythropoietin therapy
Increased iron loss
Chronic blood loss
Menses
Acute blood loss
Blood donation
Phlebotomy as treatment for polycythemia vera
Decreased iron intake or absorption
Inadequate diet
Malabsorption from disease (sprue, Crohn's disease)
Malabsorption from surgery (postgastrectomy)
Acute or chronic inflammation

deficiency in an adult man means gastrointestinal blood loss until proven otherwise. Signs related to iron deficiency depend on the severity and chronicity of the anemia in addition to the usual signs of anemia—fatigue, pallor, and reduced exercise capacity. *Cheilosis* (fissures at the corners of the mouth) and *koilonychia* (spooning of the fingernails) are signs of advanced tissue iron deficiency. The diagnosis of iron deficiency is typically based on laboratory results.

**LABORATORY IRON STUDIES****Serum Iron and Total Iron-Binding Capacity**

The serum iron level represents the amount of circulating iron bound to transferrin. The TIBC is an indirect measure of the circulating transferrin. The normal range for the serum iron is 50–150  $\mu\text{g}/\text{dL}$ ; the normal range for TIBC is 300–360  $\mu\text{g}/\text{dL}$ . Transferrin saturation, which is normally 25–50%, is obtained by the following formula:  $\text{serum iron} \times 100 \div \text{TIBC}$ . Iron-deficiency states are associated with saturation levels <18%. In evaluating the serum iron, the clinician should be aware of a diurnal variation in the value. A transferrin saturation >50% indicates that a disproportionate amount of the iron bound to transferrin is being delivered to nonerythroid tissues. If this persists for an extended time, tissue iron overload may occur.

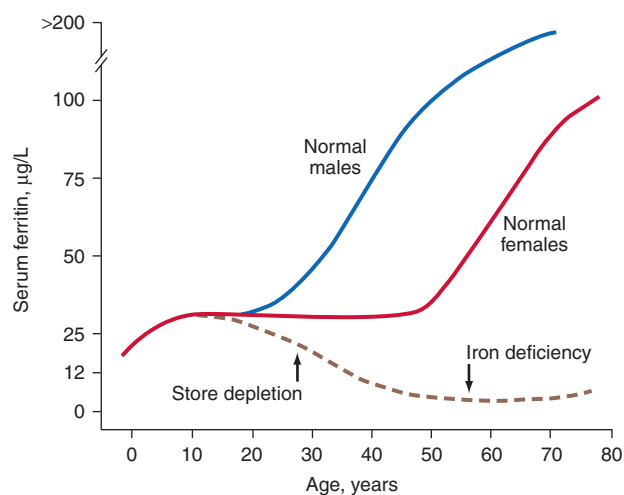
**Serum Ferritin**

Free iron is toxic to cells, and the body has established an elaborate set of protective mechanisms to bind iron in various tissue compartments. Within cells, iron is stored complexed to protein as ferritin or hemosiderin. Apoferritin binds to free ferrous iron and stores it in

the ferric state. As ferritin accumulates within cells of the RE system, protein aggregates are formed as hemosiderin. Iron in ferritin or hemosiderin can be extracted for release by the RE cells, although hemosiderin is less readily available. Under steady-state conditions, the serum ferritin level correlates with total body iron stores; thus the serum ferritin level is the most convenient laboratory test to estimate iron stores. The normal value for ferritin varies according to the age and gender of the individual (**Fig. 7-3**). Adult men have serum ferritin values averaging about 100  $\mu\text{g}/\text{L}$ ; adult women have levels averaging 30  $\mu\text{g}/\text{L}$ . As iron stores are depleted, the serum ferritin falls to <15  $\mu\text{g}/\text{L}$ . Such levels are diagnostic of absent body iron stores.

**Evaluation of Bone Marrow Iron Stores**

Although RE cell iron stores can be estimated from the iron stain of a bone marrow aspirate or biopsy, the measurement of serum ferritin has largely supplanted bone marrow aspirates for determination of storage iron (**Table 7-3**). The serum ferritin level is a better indicator of iron overload than the marrow iron stain. However, in addition to storage iron, the marrow iron stain provides information about the effective delivery of iron to developing erythroblasts. Normally, when the marrow smear is stained for iron, 20–40% of developing erythroblasts—called *sideroblasts*—have visible ferritin granules in their cytoplasm. This represents iron in excess of that needed for hemoglobin synthesis. In states in which release of iron from storage sites is blocked, RE iron is detectable, and there are few or no sideroblasts. In the myelodysplastic syndromes, mitochondrial dysfunction can occur, and



**FIGURE 7-3** Serum ferritin levels as a function of sex and age. Iron-store depletion and iron deficiency are accompanied by a fall in serum ferritin level below 20  $\mu\text{g}/\text{L}$ . (From Hillman et al, with permission.)

TABLE 7-3

IRON STORE MEASUREMENTS		
IRON STORES	MARROW IRON STAIN, 0-4+	SERUM FERRITIN, $\mu\text{g/L}$
0	0	<15
1-300 mg	Trace-1+	15-30
300-800 mg	2+	30-60
800-1000 mg	3+	60-150
1-2 g	4+	>150
Iron overload	—	>500-1000

accumulation of iron in mitochondria appears in a necklace fashion around the nucleus of the erythroblast. Such cells are referred to as *ringed sideroblasts*.

### Red Cell Protoporphyrin Levels

Protoporphyrin is an intermediate in the pathway to heme synthesis. Under conditions in which heme synthesis is impaired, protoporphyrin accumulates within the red cell. This reflects an inadequate iron supply to erythroid precursors to support hemoglobin synthesis. Normal values are <30  $\mu\text{g/dL}$  of red cells. In iron deficiency, values >100  $\mu\text{g/dL}$  are seen. The most common causes of increased red cell protoporphyrin levels are absolute or relative iron deficiency and lead poisoning.

### Serum Levels of Transferrin Receptor Protein

Because erythroid cells have the highest numbers of transferrin receptors on their surface of any cell in the body, and because transferrin receptor protein (TRP) is released by cells into the circulation, serum levels of TRP reflect the total erythroid marrow mass. Another condition in which TRP levels are elevated is absolute iron deficiency. Normal values are 4-9  $\mu\text{g/L}$  determined by immunoassay. This laboratory test is becoming

TABLE 7-4

DIAGNOSIS OF MICROCYTIC ANEMIA				
TESTS	IRON DEFICIENCY	INFLAMMATION	THALASSEMIA	SIDEROBLASTIC ANEMIA
Smear	Micro/hypo	Normal micro/hypo	Micro/hypo with targeting	Variable
SI	<30	<50	Normal to high	Normal to high
TIBC	>360	<300	Normal	Normal
Percent saturation	<10	10-20	30-80	30-80
Ferritin ( $\mu\text{g/L}$ )	<15	30-200	50-300	50-300
Hemoglobin pattern	Normal	Normal	Abnormal	Normal

**Note:** SI, serum iron; TIBC, total iron-binding capacity.

increasingly available and, along with the serum ferritin, has been proposed to distinguish between iron deficiency and the anemia of chronic inflammation (see later).

### DIFFERENTIAL DIAGNOSIS

Other than iron deficiency, only three conditions need to be considered in the differential diagnosis of a hypochromic microcytic anemia (Table 7-4). The first is an inherited defect in globin chain synthesis: the thalassemias. These are differentiated from iron deficiency most readily by serum iron values; normal or increased serum iron levels and transferrin saturation are characteristic of the thalassemias.

The second condition is the anemia of chronic inflammation with inadequate iron supply to the erythroid marrow. The distinction between true iron-deficiency anemia and the anemia associated with chronic inflammation is among the most common diagnostic problems that clinicians encounter (see later). Usually the anemia of chronic inflammation is normocytic and normochromic. The iron values usually make the differential diagnosis clear because the ferritin level is normal or increased and the percentages of transferrin saturation and TIBC are typically below normal.

Finally, the myelodysplastic syndromes represent the third and least common condition. Occasionally, patients with myelodysplasia have impaired hemoglobin synthesis with mitochondrial dysfunction, resulting in impaired iron incorporation into heme. The iron values again reveal normal stores and more than an adequate supply to the marrow, despite the microcytosis and hypochromia.

### **Rx** Treatment: IRON-DEFICIENCY ANEMIA

The severity and cause of iron-deficiency anemia determine the appropriate approach to treatment. As an example, symptomatic elderly patients with severe

iron-deficiency anemia and cardiovascular instability may require red cell transfusions. Younger individuals who have compensated for their anemia can be treated more conservatively with iron replacement. The foremost issue for the latter patient is the precise identification of the cause of the iron deficiency.

For most cases of iron deficiency (pregnant women, growing children and adolescents, patients with infrequent episodes of bleeding, and those with inadequate dietary intake of iron), oral iron therapy suffices. For patients with unusual blood loss or malabsorption, specific diagnostic tests and appropriate therapy take priority. Once the diagnosis of iron-deficiency anemia and its cause is made, there are three major therapeutic approaches.

**RED CELL TRANSFUSION** Transfusion therapy is reserved for individuals who have symptoms of anemia, cardiovascular instability, continued and excessive blood loss from whatever source, and require immediate intervention. The management of these patients is less related to the iron deficiency than it is to the consequences of the severe anemia. Not only do transfusions correct the anemia acutely, but the transfused red cells provide a source of iron for reutilization, assuming they are not lost through continued bleeding. Transfusion therapy stabilizes the patient while other options are reviewed.

**ORAL IRON THERAPY** In the asymptomatic patient with established iron-deficiency anemia, treatment with oral iron is usually adequate. Multiple preparations are available, ranging from simple iron salts to complex iron compounds designed for sustained release throughout the small intestine (Table 7-5). Although the various preparations contain different amounts of iron, they are generally all absorbed well and are effective in treatment. Some come with other compounds designed to enhance iron absorption, such as ascorbic acid. It is not clear whether the benefits of

such compounds justify their costs. Typically, for iron replacement therapy, up to 300 mg of elemental iron per day is given, usually as three or four iron tablets (each containing 50–65 mg elemental iron) given over the course of the day. Ideally, oral iron preparations should be taken on an empty stomach because foods may inhibit iron absorption. Some patients with gastric disease or prior gastric surgery require special treatment with iron solutions because the retention capacity of the stomach may be reduced. The retention capacity is necessary for dissolving the shell of the iron tablet before the release of iron. A dose of 200–300 mg of elemental iron per day should result in the absorption of iron up to 50 mg/d. This supports a red cell production level of two to three times normal in an individual with a normally functioning marrow and appropriate erythropoietin stimulus. However, as the hemoglobin level rises, erythropoietin stimulation decreases, and the amount of iron absorbed is reduced. The goal of therapy in individuals with iron-deficiency anemia is not only to repair the anemia, but also to provide stores of at least 0.5–1.0 g of iron. Sustained treatment for a period of 6–12 months after correction of the anemia is necessary to achieve this goal.

Of the complications of oral iron therapy, gastrointestinal distress is the most prominent and experienced by 15–20% of patients. Abdominal pain, nausea, vomiting, or constipation may lead to noncompliance. Although small doses of iron or iron preparations with delayed release may help somewhat, the gastrointestinal side effects are a major impediment to the effective treatment of a number of patients.

The response to iron therapy varies, depending on the erythropoietin (EPO) stimulus and the rate of absorption. Typically, the reticulocyte count should begin to increase within 4–7 days after initiation of therapy and peak at 1.5 weeks. The absence of a response may be due to poor absorption, noncompliance (which is common), or a confounding diagnosis. A useful test in the clinic to determine the patient's ability to absorb iron is the *iron tolerance test*. Two iron tablets are given to the patient on an empty stomach, and the serum iron is measured serially over the subsequent 2 hours. Normal absorption will result in an increase in the serum iron of at least 100 µg/dL. If iron deficiency persists despite adequate treatment, it may be necessary to switch to parenteral iron therapy.

**Parenteral Iron Therapy** Intravenous iron can be given to patients who are unable to tolerate oral iron; whose needs are relatively acute; or who need iron on an ongoing basis, usually due to persistent gastrointestinal blood loss. Parenteral iron use has been rising rapidly in the last several years with the recognition that recombinant EPO therapy induces a large demand for iron—a demand that frequently cannot be met

TABLE 7-5

## ORAL IRON PREPARATIONS

GENERIC NAME	TABLET (IRON CONTENT), mg	ELIXIR (IRON CONTENT), mg IN 5 mL
Ferrous sulfate	325 (65)	300 (60)
	195 (39)	90 (18)
Extended release	525 (105)	
Ferrous fumarate	325 (107)	
	195 (64)	100 (33)
Ferrous gluconate	325 (39)	300 (35)
Polysaccharide iron	150 (150)	100 (100)
	50 (50)	

through the physiologic release of iron from RE sources. The safety of parenteral iron—particularly iron dextran—has been a concern. The serious adverse reaction rate to intravenous iron dextran is 0.7%. Fortunately, newer iron complexes are available in the United States, such as sodium ferric gluconate (Ferrlecit) and iron sucrose (Venofer), that have a much lower rate of adverse effects.

Parenteral iron is used in two ways: one is to administer the total dose of iron required to correct the hemoglobin deficit and provide the patient with at least 500 mg of iron stores; the second is to give repeated small doses of parenteral iron over a protracted period. The latter approach is common in dialysis centers, where it is not unusual for 100 mg of elemental iron to be given weekly for 10 weeks to augment the response to recombinant EPO therapy. The amount of iron needed by an individual patient is calculated by the following formula:

$$\text{Body weight (kg)} \times 2.3 \times (15 - \text{patient's hemoglobin, g/dL}) + 500 \text{ or } 1000 \text{ mg (for stores).}$$

In administering intravenous iron dextran, anaphylaxis is a concern. Anaphylaxis is much rarer with the newer preparations. The factors that have correlated with an anaphylactic-like reaction include a history of multiple allergies or a prior allergic reaction to dextran (in the case of iron dextran). Generalized symptoms appearing several days after the infusion of a large dose of iron can include arthralgias, skin rash, and low-grade fever. This may be dose-related, but it does not preclude the further use of parenteral iron in the patient. To date, patients with sensitivity to iron dextran have been safely treated with iron gluconate. If a large dose of iron dextran is to be given (>100 mg), the iron preparation should be diluted in 5% dextrose in water or 0.9% NaCl solution. The iron solution can then be infused over a 60- to 90-minute period (for larger doses) or at a rate convenient for the attending nurse or physician. While a test dose (25 mg) of parenteral iron dextran is recommended, in reality a slow infusion of a larger dose of parenteral iron solution will afford the same kind of early warning as a separately injected test dose. Early in the infusion of iron, if chest pain, wheezing, a fall in blood pressure, or other systemic symptoms occur, the infusion of iron should be stopped immediately.

## OTHER HYPOPROLIFERATIVE ANEMIAS

In addition to mild to moderate iron-deficiency anemia, the hypoproliferative anemias can be divided into four categories: (1) chronic inflammation, (2) renal disease, (3) endocrine and nutritional deficiencies (hypometabolic states), and (4) marrow damage (Chap. 11). With chronic inflammation, renal disease, or hypometabolism,

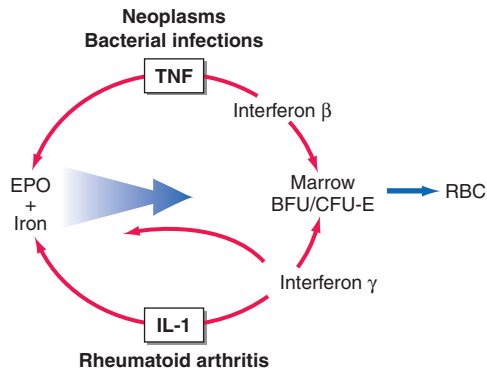
endogenous EPO production is inadequate for the degree of anemia observed. For the anemia of chronic inflammation, the erythroid marrow also responds inadequately to stimulation, due in part to defects in *iron reutilization*. As a result of the lack of adequate EPO stimulation, an examination of the peripheral blood smear will disclose only an occasional polychromatophilic (“shift”) reticulocyte. In cases of iron deficiency or marrow damage, appropriate elevations in endogenous EPO levels are typically found, and shift reticulocytes will be present on the blood smear.

## ANEMIA OF ACUTE AND CHRONIC INFLAMMATION/INFECTION (THE ANEMIA OF CHRONIC DISEASE)

The anemia of chronic disease—which encompasses inflammation, infection, tissue injury, and conditions (such as cancer) associated with the release of proinflammatory cytokines—is one of the most common forms of anemia seen clinically and probably the most important in the differential diagnosis of iron deficiency because many of the features of the anemia are brought about by inadequate iron delivery to the marrow, despite the presence of normal or increased iron stores. This is reflected by a low serum iron, increased red cell protoporphyrin, a hypoproliferative marrow, transferrin saturation in the range of 15–20%, and a normal or increased serum ferritin. The serum ferritin values are often the most distinguishing feature between true iron-deficiency anemia and the iron-deficient erythropoiesis associated with inflammation. Typically, serum ferritin values increase threefold over basal levels in the face of inflammation. All of these changes are due to the effects of inflammatory cytokines and hepcidin, the key iron regulatory hormone, acting at several levels of erythropoiesis (Fig. 7-4).

Interleukin 1 (IL-1) directly decreases EPO production in response to anemia. IL-1, acting through accessory cell release of interferon  $\gamma$  (IFN- $\gamma$ ), suppresses the response of the erythroid marrow to EPO—an effect that can be overcome by EPO administration in vitro and in vivo. In addition, tumor necrosis factor (TNF), acting through the release of IFN- $\gamma$  by marrow stromal cells, also suppresses the response to EPO. Hepcidin, made by the liver, is increased in inflammation and acts to suppress iron absorption and iron release from storage sites. The overall result is a chronic hypoproliferative anemia with classic changes in iron metabolism. The anemia is further compounded by a mild to moderate shortening in red cell survival.

With chronic inflammation, the primary disease determines the severity and characteristics of the anemia. For instance, many patients with cancer also have anemia that is typically normocytic and normochromic. In contrast, patients with long-standing active rheumatoid

**FIGURE 7-4****Suppression of erythropoiesis by inflammatory cytokines.**

Through the release of tumor necrosis factor (TNF) and interferon  $\gamma$  (IFN- $\gamma$ ), neoplasms and bacterial infections suppress erythropoietin (EPO) production and the proliferation of erythroid progenitors [erythroid burst-forming units and erythroid colony-forming units (BFU/CFU-E)]. The mediators in patients with vasculitis and rheumatoid arthritis include interleukin 1 (IL-1) and IFN- $\gamma$ . The red arrows indicate sites of inflammatory cytokine inhibitory effects.

arthritis or chronic infections such as tuberculosis have a microcytic, hypochromic anemia. In both cases, the bone marrow is hypoproliferative, but the differences in red cell indices reflect differences in the availability of iron for hemoglobin synthesis. Occasionally, conditions associated with chronic inflammation are also associated with chronic blood loss. Under these circumstances, a bone marrow aspirate stained for iron may be necessary to rule out absolute iron deficiency. However, the administration of iron in this case will correct the iron-deficiency component of the anemia and leave the inflammatory component unaffected.

The anemia associated with acute infection or inflammation is typically mild but becomes more pronounced over time. Acute infection can produce a fall in hemoglobin levels of 2–3 g/dL within 1 or 2 days; this is largely

related to the hemolysis of red cells near the end of their natural life span. The fever and cytokines released exert a selective pressure against cells with more limited capacity to maintain the red cell membrane. In most individuals the mild anemia is reasonably well tolerated, and symptoms, if present, are associated with the underlying disease. Occasionally, in patients with preexisting cardiac disease, moderate anemia (hemoglobin 10–11 g/dL) may be associated with angina, exercise intolerance, and shortness of breath. **Table 7-6** shows the erythropoietic profile that distinguishes the anemia of inflammation from the other causes of hypoproliferative anemias.

**ANEMIA OF RENAL DISEASE**

Chronic renal failure is usually associated with a moderate to severe hypoproliferative anemia; the level of the anemia correlates with the severity of the renal failure. Red cells are typically normocytic and normochromic, and reticulocytes are decreased. The anemia is primarily due to a failure to produce adequate amounts of EPO and a reduction in red cell survival. In certain forms of acute renal failure, the correlation between the anemia and renal function is weaker. Patients with the hemolytic-uremic syndrome increase erythropoiesis in response to the hemolysis, despite renal failure requiring dialysis. Polycystic kidney disease also shows a smaller degree of EPO deficiency for a given level of renal failure. By contrast, patients with diabetes or myeloma have more severe EPO deficiency for a given level of renal failure.

Assessment of iron status provides information to distinguish the anemia of renal disease from the other forms of hypoproliferative anemia (**Table 7-6**) and to guide management. Patients with the anemia of renal disease usually present with normal serum iron, TIBC, and ferritin levels. However, those maintained on chronic hemodialysis may develop iron deficiency from blood loss through the dialysis procedure. Iron must be replenished in these patients to ensure an adequate response to EPO therapy (see later).

**TABLE 7-6****DIAGNOSIS OF HYPOPROLIFERATIVE ANEMIAS**

TESTS	IRON DEFICIENCY	INFLAMMATION	RENAL DISEASE	HYPOMETABOLIC STATES
Anemia	Mild to severe	Mild	Mild to severe	Mild
MCV (fL)	60–90	80–90	90	90
Morphology	Normo-microcytic	Normocytic	Normocytic	Normocytic
SI	<30	<50	Normal	Normal
TIBC	>360	<300	Normal	Normal
Saturation (%)	<10	10–20	Normal	Normal
Serum ferritin ( $\mu$ g/L)	<15	30–200	115–150	Normal
Iron stores	0	2–4+	1–4+	Normal

**Note:** MCV, mean corpuscular volume; SI, serum iron; TIBC, total iron-binding capacity.

## ANEMIA IN HYPOMETABOLIC STATES

Patients who are starving, particularly for protein, and those with a variety of endocrine disorders that produce lower metabolic rates, may develop a mild to moderate hypoproliferative anemia. The release of EPO from the kidney is sensitive to the need for O<sub>2</sub>, not just O<sub>2</sub> levels. Thus EPO production is triggered at lower levels of blood O<sub>2</sub> content in disease states (such as hypothyroidism and starvation) where metabolic activity, and thus O<sub>2</sub> demand, is decreased.

### Endocrine Deficiency States

The difference in the levels of hemoglobin between men and women is related to the effects of androgen and estrogen on erythropoiesis. Testosterone and anabolic steroids augment erythropoiesis; castration and estrogen administration to males decrease erythropoiesis. Patients who are hypothyroid or have deficits in pituitary hormones also may develop a mild anemia. Pathogenesis may be complicated by other nutritional deficiencies because iron and folic acid absorption can be affected by these disorders. Usually, correction of the hormone deficiency reverses the anemia.

Anemia may be more severe in Addison's disease, depending on the level of thyroid and androgen hormone dysfunction; however, anemia may be masked by decreases in plasma volume. Once such patients are given cortisol and volume replacement, the hemoglobin level may fall rapidly. Mild anemia complicating hyperparathyroidism may be due to decreased EPO production as a consequence of the renal effects of hypercalcemia or to impaired proliferation of erythroid progenitors.

### Protein Starvation

Decreased dietary intake of protein may lead to mild to moderate hypoproliferative anemia; this form of anemia may be prevalent in the elderly. The anemia can be more severe in patients with a greater degree of starvation. In marasmus, where patients are both protein- and calorie-deficient, the release of EPO is impaired in proportion to the reduction in metabolic rate; however, the degree of anemia may be masked by volume depletion and becomes apparent after refeeding. Deficiencies in other nutrients (iron, folate) may also complicate the clinical picture but may not be apparent at diagnosis. Changes in the erythrocyte indices on refeeding should prompt evaluation of iron, folate, and B<sub>12</sub> status.

### Anemia in Liver Disease

A mild hypoproliferative anemia may develop in patients with chronic liver disease from nearly any cause. The peripheral blood smear may show spur cells

and stomatocytes from the accumulation of excess cholesterol in the membrane from a deficiency of lecithin cholesterol acyltransferase. Red cell survival is shortened, and the production of EPO is inadequate to compensate. In alcoholic liver disease, nutritional deficiencies are common and complicate the management. Folate deficiency from inadequate intake, as well as iron deficiency from blood loss and inadequate intake, can alter the red cell indices.

### **Rx** Treatment: HYPOPROLIFERATIVE ANEMIAS

Many patients with hypoproliferative anemias experience recovery of normal hemoglobin levels when the underlying disease is appropriately treated. For those in whom such reversals are not possible—such as patients with end-stage kidney disease, cancer, and chronic inflammatory diseases—symptomatic anemia requires treatment. The two major forms of treatment are transfusions and EPO.

**TRANSFUSIONS** Thresholds for transfusion should be altered based on the patient's symptoms. In general, patients without serious underlying cardiovascular or pulmonary disease can tolerate hemoglobin levels >8 g/dL and do not require intervention until the hemoglobin falls below that level. Patients with more physiologic compromise may need to have their hemoglobin levels kept above 11 g/dL. A typical unit of packed red cells increases the hemoglobin level by 1 g/dL. Transfusions are associated with certain infectious risks (Chap. 12), and chronic transfusions can produce iron overload. Importantly, the liberal use of blood has been associated with increased morbidity and mortality, particularly in the intensive care setting. Therefore, in the absence of documented tissue hypoxia, a conservative approach to the use of red cell transfusions is preferable.

**ERYTHROPOIETIN** EPO is particularly useful in anemias in which endogenous EPO levels are inappropriately low, such as the hypoproliferative anemias. Iron status must be evaluated and iron repleted to obtain optimal effects from EPO. In patients with chronic renal failure, the usual dose of EPO is 50–150 U/kg three times a week intravenously. Hemoglobin levels of 10–12 g/dL are usually reached within 4–6 weeks if iron levels are adequate; 90% of these patients respond. Once a target hemoglobin level is achieved, the EPO dose can be decreased. A fall in hemoglobin level occurring in the face of EPO therapy usually signifies the development of an infection or iron depletion. Aluminum toxicity and hyperparathyroidism can also compromise the EPO response. When an infection intervenes, it is best to interrupt the EPO therapy and



rely on transfusion to correct the anemia until the infection is adequately treated. The dose needed to correct the anemia in patients with cancer is higher, up to 300 U/kg three times a week, and only ~60% of patients respond.

Longer-acting preparations of EPO can reduce the frequency of injections. Darbepoetin alfa, a molecularly modified EPO with additional carbohydrate, has a half-life in the circulation that is three to four times longer than epoetin alfa, permitting weekly or every other week dosing.

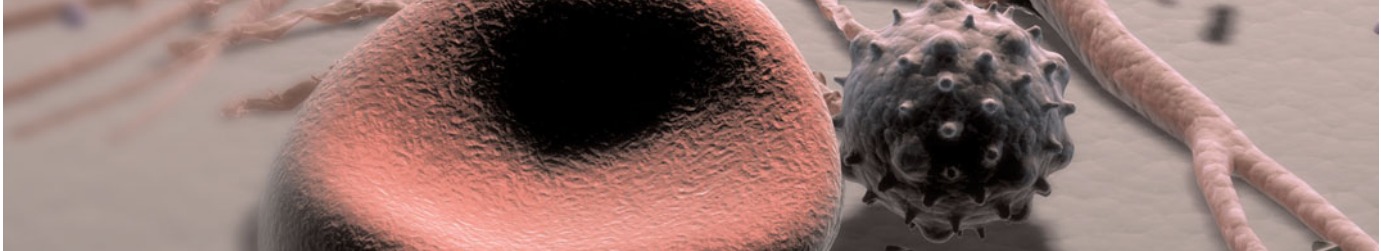
#### ACKNOWLEDGMENT

*Dr. Robert S. Hillman was the author of this chapter in the 14th edition of Harrison's Principles of Internal Medicine, and material from his chapter has been retained.*

#### FURTHER READINGS

BAILIE GR et al: Parenteral iron use in the management of anemia in end-stage renal disease patients. *Am J Kidney Dis* 35:1, 2000

- BRUGNARA C: Iron deficiency and erythropoiesis: New diagnostic approaches. *Clin Chem* 49:1573, 2003
- CLARK SF: Iron deficiency anemia: Diagnosis and management. *Curr Opin Gastroenterol* 25:122, 2009
- FLEMING RE, BACON BR: Orchestration of iron homeostasis. *N Engl J Med* 352:1741, 2005
- GANZ T: Heparin, a key regulator of iron metabolism and mediator of inflammation. *Blood* 102:783, 2003
- HAYAT A: Safety issues with intravenous iron products in the management of anemia in chronic kidney disease. *Clin Med Res* 6:93, 2009
- HILLMAN RS et al: *Hematology in Clinical Practice*, 4th ed. New York, McGraw-Hill, 2005
- LEE PL, BEUTLER E: Regulation of hepcidin and iron-overload disease. *Annu Rev Pathol* 4:489, 2009
- MASSYN MW, KHAN SA: Heyde syndrome: A common diagnosis in older patients with severe aortic stenosis. *Age Ageing* 38:267, 2009
- STOLTZFUS RF: Iron deficiency: Global prevalence and consequences. *Food Nutr Bull* 24(Suppl 4):S99, 2003
- THOMAS C et al: The diagnostic plot: A concept for identifying different states of iron deficiency and monitoring the response to epoetin therapy. *Med Oncol* 23:23, 2006



## CHAPTER 8

# DISORDERS OF HEMOGLOBIN

Edward J. Benz, Jr.

■ Properties of the Human Hemoglobins . . . . .	81	■ Thalassemia Syndromes . . . . .	90
Hemoglobin Structure . . . . .	81	Clinical Manifestations of $\beta$ -Thalassemia Syndromes . . . . .	90
Function of Hemoglobin . . . . .	82	$\alpha$ -Thalassemia Syndromes . . . . .	91
Developmental Biology of Human Hemoglobins . . . . .	83	Diagnosis and Management of Thalassemias . . . . .	92
Genetics and Biosynthesis of Human Hemoglobin . . . . .	83	Prevention . . . . .	92
■ Classification of Hemoglobinopathies . . . . .	83	■ Thalassemic Structural Variants . . . . .	92
Epidemiology . . . . .	84	Hemoglobin Lepore . . . . .	92
Inheritance and Ontogeny . . . . .	84	Hemoglobin E . . . . .	92
■ Detection and Characterization of Hemoglobinopathies:		Hereditary Persistence of Fetal Hemoglobin . . . . .	93
General Methods . . . . .	84	Acquired Hemoglobinopathies . . . . .	93
■ Structurally Abnormal Hemoglobins . . . . .	85	■ Experimental Therapies . . . . .	94
Sickle Cell Syndromes . . . . .	85	Bone Marrow Transplantation, Gene Therapy, and Manipulation of HbF . . . . .	94
Unstable Hemoglobins . . . . .	88	■ Aplastic and Hypoplastic Crisis in Patients with Hemoglobinopathies . . . . .	94
Hemoglobins with Altered Oxygen Affinity . . . . .	89	■ Further Readings . . . . .	94
Methemoglobinemias . . . . .	89		
Diagnosis and Management of Patients with Unstable Hemoglobins, High-Affinity Hemoglobins, and Methemoglobinemia . . . . .	89		

Hemoglobin is critical for normal oxygen delivery to tissues; it is also present in erythrocytes in such high concentrations that it can alter red cell shape, deformability, and viscosity. Hemoglobinopathies are disorders affecting the structure, function, or production of hemoglobin. These conditions are usually inherited and range in severity from asymptomatic laboratory abnormalities to death in utero. Different forms may present as hemolytic anemia, erythrocytosis, cyanosis, or vasoocclusive stigmata.

### PROPERTIES OF THE HUMAN HEMOGLOBINS

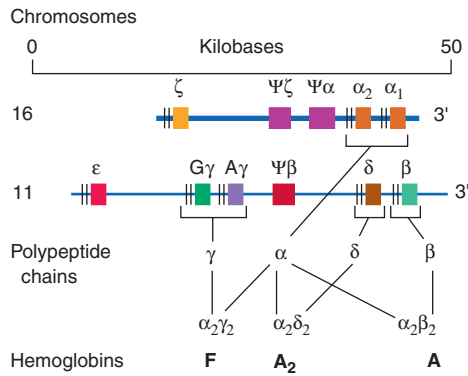
#### HEMOGLOBIN STRUCTURE

Different hemoglobins are produced during embryonic, fetal, and adult life (Fig. 8-1). Each consists of a tetramer of globin polypeptide chains: a pair of  $\alpha$ -like chains 141 amino acids long and a pair of  $\beta$ -like chains 146 amino acids long. The major adult hemoglobin,

HbA, has the structure  $\alpha_2\beta_2$ . HbF ( $\alpha_2\gamma_2$ ) predominates during most of gestation, and HbA<sub>2</sub> ( $\alpha_2\delta_2$ ) is minor adult hemoglobin. Embryonic hemoglobins need not be considered here.

Each globin chain enfolds a single heme moiety, consisting of a protoporphyrin IX ring complexed with a single iron atom in the ferrous state ( $\text{Fe}^{2+}$ ). Each heme moiety can bind a single oxygen molecule; a molecule of hemoglobin can transport up to four oxygen molecules.

The amino acid sequences of the various globins are highly homologous to one another. Each has a highly helical *secondary structure*. Their globular *tertiary structures* can cause the exterior surfaces to be rich in polar (hydrophilic) amino acids that enhance solubility and the interior to be lined with nonpolar groups, forming a hydrophobic pocket into which heme is inserted. The tetrameric *quaternary structure* of HbA contains two  $\alpha\beta$  dimers. Numerous tight interactions (i.e.,  $\alpha_1\beta_1$  contacts) hold the  $\alpha$  and  $\beta$  chains together. The complete tetramer is held together by interfaces (i.e.,  $\alpha_1\beta_2$  contacts) between the  $\alpha$ -like chain of one dimer and the non- $\alpha$  chain of the other dimer.



**FIGURE 8-1**

**The globin genes.** The  $\alpha$ -like genes ( $\alpha, \zeta$ ) are encoded on chromosome 16; the  $\beta$ -like genes ( $\beta, \gamma, \delta, \epsilon$ ) are encoded on chromosome 11. The  $\zeta$  and  $\epsilon$  genes encode embryonic globins.

The hemoglobin tetramer is highly soluble, but individual globin chains are insoluble. Unpaired globin precipitates, forming inclusions that damage the cell. Normal globin chain synthesis is balanced so that each newly synthesized  $\alpha$  or non- $\alpha$  globin chain has an available partner with which to pair.

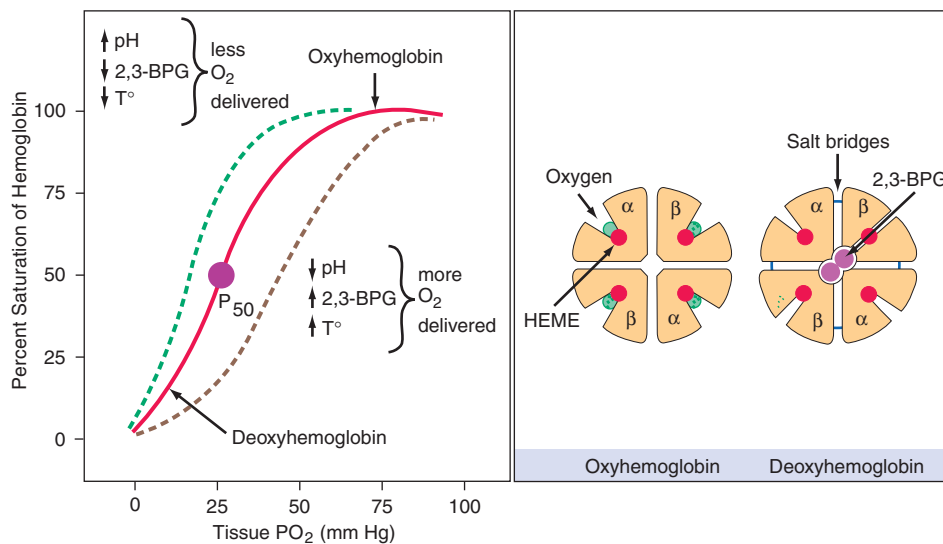
Solubility and reversible oxygen binding are the key properties deranged in hemoglobinopathies. Both depend most on the hydrophilic surface amino acids, the

hydrophobic amino acids lining the heme pocket, a key histidine in the F helix, and the amino acids forming the  $\alpha_1\beta_1$  and  $\alpha_1\beta_2$  contact points. Mutations in these strategic regions tend to be the ones that alter clinical behavior.

## FUNCTION OF HEMOGLOBIN

To support oxygen transport, hemoglobin must bind  $O_2$  efficiently at the partial pressure of oxygen ( $P_{O_2}$ ) of the alveolus, retain it, and release it to tissues at the  $P_{O_2}$  of tissue capillary beds. Oxygen acquisition and delivery over a relatively narrow range of oxygen tensions depends on a property inherent in the tetrameric arrangement of heme and globin subunits within the hemoglobin molecule called *cooperativity* or *heme-heme interaction*.

At low oxygen tensions, the hemoglobin tetramer is fully deoxygenated (Fig. 8-2). Oxygen binding begins slowly as  $O_2$  tension rises. However, as soon as some oxygen has been bound by the tetramer, an abrupt increase occurs in the slope of the curve. Thus hemoglobin molecules that have bound some oxygen develop a higher oxygen affinity, greatly accelerating their ability to combine with more oxygen. This S-shaped oxygen equilibrium curve (Fig. 8-2), along which substantial amounts of oxygen *loading and unloading* can occur over a narrow range of oxygen tensions, is physiologically more useful than the high-affinity hyperbolic curve of individual monomers.



**FIGURE 8-2**

**Hemoglobin-oxygen dissociation curve.** The hemoglobin tetramer can bind up to four molecules of oxygen in the iron-containing sites of the heme molecules. As oxygen is bound, 2,3-BPG and  $CO_2$  are expelled. Salt bridges are broken, and each of the globin molecules changes its conformation to facilitate  $O_2$  binding.  $O_2$  release to the tissues is the reverse process, salt bridges being formed and 2,3-BPG

and  $CO_2$  bound. Deoxyhemoglobin does not bind  $O_2$  efficiently until the cell returns to conditions of higher pH, the most important modulator of  $O_2$  affinity (Bohr effect). When acid is produced in the tissues, the dissociation curve shifts to the right, facilitating  $O_2$  release and  $CO_2$  binding. Alkalosis has the opposite effect, reducing  $O_2$  delivery.

Oxygen affinity is modulated by several factors. The Bohr effect is the ability of hemoglobin to deliver more oxygen to tissues at low pH. It arises from the stabilizing action of protons on deoxyhemoglobin, which binds protons more readily than oxyhemoglobin because it is a weaker acid (Fig. 8-2). Thus hemoglobin has a lower oxygen affinity at low pH. The major small molecule that alters oxygen affinity in humans is 2,3-bisphosphoglycerate (2,3-BPG, formerly 2,3-DPG), which lowers oxygen affinity when bound to hemoglobin. HbA has a reasonably high affinity for 2,3-BPG. HbF does not bind 2,3-BPG, so it tends to have a higher oxygen affinity *in vivo*. Hemoglobin also binds nitric oxide reversibly; this interaction may influence vascular tone, but its physiologic relevance remains unclear.

Proper oxygen transport depends on the tetrameric structure of the proteins, the proper arrangement of the charged amino acids, and interaction with protons or 2,3-BPG.

## DEVELOPMENTAL BIOLOGY OF HUMAN HEMOGLOBINS

Red cells first appearing at ~6 weeks after conception contain the embryonic hemoglobins Hb Portland ( $\zeta_2\gamma_2$ ), Hb Gower I ( $\zeta_2\varepsilon_2$ ), and Hb Gower II ( $\alpha_2\varepsilon_2$ ). At 10–11 weeks, fetal hemoglobin (HbF;  $\alpha_2\gamma_2$ ) becomes predominant. The switch to nearly exclusive synthesis of adult hemoglobin (HbA;  $\alpha_2\beta_2$ ) occurs at ~38 weeks (Fig. 8-1). Fetuses and newborns therefore require  $\alpha$ -globin but not  $\beta$ -globin for normal gestation. Small amounts of HbF are produced during postnatal life. A few red cell clones called *F cells* are progeny of a small pool of immature committed erythroid precursors (BFU-e) that retain the ability to produce HbF. Profound erythroid stresses, such as severe hemolytic anemias, bone marrow transplant, or cancer chemotherapy, cause more of the F-potent BFU-e to be recruited. HbF levels thus tend to rise in some patients with sickle cell anemia or thalassemia. This phenomenon is also important because it probably explains the ability of hydroxyurea to increase levels of HbF in adults. Agents such as butyrate that inhibit histone deacetylase and modify chromatin structure can also activate fetal globin genes partially after birth.

## GENETICS AND BIOSYNTHESIS OF HUMAN HEMOGLOBIN

The human hemoglobins are encoded in two tightly linked gene clusters; the  $\alpha$ -like globin genes are clustered on chromosome 16, and the  $\beta$ -like genes on chromosome 11 (Fig. 8-1). The  $\alpha$ -like cluster consists of two  $\alpha$ -globin genes and a single copy of the  $\zeta$  gene. The non- $\alpha$  gene cluster consists of a single  $\varepsilon$  gene, the  $G\gamma$  and  $A\gamma$  fetal globin genes, and the adult  $\delta$  and  $\beta$  genes.

Important regulatory sequences flank each gene. Immediately upstream are typical promoter elements needed for the assembly of the transcription initiation complex. Sequences in the 5' flanking region of the  $\gamma$  and the  $\beta$  genes appear to be crucial for the correct developmental regulation of these genes; elements that function like classic enhancers and silencers are in the 3' flanking regions. The locus control region (LCR) elements located far upstream appear to control the overall level of expression of each cluster. These elements achieve their regulatory effects by interacting with *trans*-acting transcription factors. Some of these factors are ubiquitous (e.g., Sp1 and YY1); others are more or less limited to erythroid cells or hematopoietic cells (e.g., GATA-1, NFE-2, and EKLF). The LCR controlling the  $\alpha$ -globin gene cluster is modulated by a SWI/SNF-like protein called *ATRX*; this protein appears to influence chromatin remodeling and DNA methylation. The association of  $\alpha$  thalassemia with mental retardation and myelodysplasia in some families appears to be related to mutations in the *ATRX* pathway. This pathway also modulates genes specifically expressed during erythropoiesis, such as those that encode the enzymes for heme biosynthesis. Normal red blood cell (RBC) differentiation requires the coordinated expression of the globin genes with the genes responsible for heme and iron metabolism. RBC precursors contain a protein,  $\alpha$ -hemoglobin stabilizing protein (AHSP), that enhances the folding and solubility of  $\alpha$  globin, which is otherwise easily denatured, leading to insoluble precipitates. These precipitates play an important role in the thalassemia syndromes and certain unstable hemoglobin disorders. Polymorphic variation in the amounts and/or functional capacity of AHSP might explain some of the clinical variability seen in patients inheriting identical thalassemia mutations. AHSP may be a therapeutic target, particularly in syndromes of intermediate severity.

## CLASSIFICATION OF HEMOGLOBINOPATHIES

There are five major classes of hemoglobinopathies (Table 8-1). *Structural hemoglobinopathies* occur when mutations alter the amino acid sequence of a globin chain, altering the physiologic properties of the variant hemoglobins and producing the characteristic clinical abnormalities. The most clinically relevant variant hemoglobins polymerize abnormally, as in sickle cell anemia, or exhibit altered solubility or oxygen-binding affinity. *Thalassemia syndromes* arise from mutations that impair production or translation of globin mRNA, leading to deficient globin chain biosynthesis. Clinical abnormalities are attributable to the inadequate supply of hemoglobin and the imbalances in the production of individual globin chains, leading to premature destruction

**CLASSIFICATION OF HEMOGLOBINOPATHIES**

- I. Structural hemoglobinopathies—hemoglobins with altered amino acid sequences that result in deranged function or altered physical or chemical properties
  - A. Abnormal hemoglobin polymerization—HbS, hemoglobin sickling
  - B. Altered O<sub>2</sub> affinity
    1. High affinity—polycythemia
    2. Low affinity—cyanosis, pseudoanemia
  - C. Hemoglobins that oxidize readily
    1. Unstable hemoglobins—hemolytic anemia, jaundice
    2. M hemoglobins—methemoglobinemia, cyanosis
- II. Thalassemias—defective biosynthesis of globin chains
  - A.  $\alpha$  Thalassemias
  - B.  $\beta$  Thalassemias
  - C.  $\delta\beta$ ,  $\gamma\delta\beta$ ,  $\alpha\beta$  Thalassemias
- III. Thalassemic hemoglobin variants—structurally abnormal Hb associated with co-inherited thalassemic phenotype
  - A. HbE
  - B. Hb Constant Spring
  - C. Hb Lepore
- IV. Hereditary persistence of fetal hemoglobin—persistence of high levels of HbF into adult life
- V. Acquired hemoglobinopathies
  - A. Methemoglobin due to toxic exposures
  - B. Sulfhemoglobin due to toxic exposures
  - C. Carboxyhemoglobin
  - D. HbH in erythroleukemia
  - E. Elevated HbF in states of erythroid stress and bone marrow dysplasia

of erythroblasts and RBC. *Thalassemic hemoglobin variants* combine features of thalassemia (e.g., abnormal globin biosynthesis) and of structural hemoglobinopathies (e.g., an abnormal amino acid sequence). *Hereditary persistence of fetal hemoglobin* (HPFH) is characterized by synthesis of high levels of fetal hemoglobin in adult life. *Acquired hemoglobinopathies* include modifications of the hemoglobin molecule by toxins (e.g., acquired methemoglobinemia) and abnormal hemoglobin synthesis (e.g., high levels of HbF production in preleukemia and  $\alpha$  thalassemia in myeloproliferative disorders).

**EPIDEMIOLOGY**

Hemoglobinopathies are especially common in areas in which malaria is endemic. This clustering of hemoglobinopathies is assumed to reflect a selective survival advantage for the abnormal RBC, which presumably provide a less hospitable environment during the obligate RBC stages of the parasitic life cycle. Very young children with  $\alpha$  thalassemia are *more*

susceptible to infection with the nonlethal *Plasmodium vivax*. Thalassemia might then favor a natural protection against infection with the more lethal *P. falciparum*.

Thalassemias are the most common genetic disorders in the world, affecting nearly 200 million people worldwide. About 15% of American blacks are silent carriers for  $\alpha$  thalassemia;  $\alpha$ -thalassemia trait (minor) occurs in 3% of American blacks and in 1–15% of persons of Mediterranean origin.  $\beta$  Thalassemia has a 10–15% incidence in individuals from the Mediterranean and Southeast Asia and 0.8% in American blacks. The number of severe cases of thalassemia in the United States is ~1000. Sickle cell disease is the most common structural hemoglobinopathy occurring in heterozygous form in ~8% of American blacks and in homozygous form in 1 in 400. Between 2% and 3% of American blacks carry a hemoglobin C allele.

**INHERITANCE AND ONTOGENY**

Hemoglobinopathies are autosomal codominant traits—compound heterozygotes who inherit a different abnormal mutant allele from each parent exhibit composite features of each. For example, patients inheriting sickle  $\beta$  thalassemia exhibit features of  $\beta$  thalassemia and sickle cell anemia. The  $\alpha$  chain is present in HbA, HbA<sub>2</sub>, and HbF;  $\alpha$ -chain mutations thus cause abnormalities in all three. The  $\alpha$ -globin hemoglobinopathies are symptomatic in utero and after birth because normal function of the  $\alpha$ -globin gene is required throughout gestation and adult life. In contrast, infants with  $\beta$ -globin hemoglobinopathies tend to be asymptomatic until 3–9 months of age when HbA has largely replaced HbF.

**DETECTION AND CHARACTERIZATION OF HEMOGLOBINOPATHIES: GENERAL METHODS**

Of the many methods available for hemoglobin analysis, electrophoretic techniques are used for routine clinical purposes. Electrophoresis at pH 8.6 on cellulose acetate membranes is especially simple, inexpensive, and reliable for initial screening. Agar gel electrophoresis at pH 6.1 in citrate buffer is often used as a complementary method because each method detects different variants. Comparison of results obtained in each system usually allows unambiguous diagnosis, but some important variants are electrophoretically silent. These mutant hemoglobins can usually be characterized by more specialized techniques such as isoelectric focusing and/or high-pressure liquid chromatography (HPLC).

Quantitation of the hemoglobin profile is often desirable. HbA<sub>2</sub> is frequently elevated in  $\beta$ -thalassemia trait and

depressed in iron deficiency. HbF is elevated in HPFH, some  $\beta$ -thalassemia syndromes, and occasional periods of erythroid stress or marrow dysplasia. For characterization of sickle cell trait, sickle thalassemia syndromes, or HbSC disease, and for monitoring the progress of exchange transfusion therapy to lower the percentage of circulating HbS, quantitation of individual hemoglobins is also required. In most laboratories, quantitation is performed only if the test is specifically ordered.

Because some variants can co-migrate with HbA or HbS (sickle hemoglobin), electrophoretic assessment should always be regarded as incomplete unless functional assays for hemoglobin sickling, solubility, or oxygen affinity are also performed, as dictated by the clinical presentation. The best sickling assays involve measurement of the degree to which the hemoglobin sample becomes insoluble, or gelled, as it is deoxygenated (i.e., sickle solubility test). Unstable hemoglobins are detected by their precipitation in isopropanol or after heating to 50°C. High- $O_2$  affinity and low- $O_2$  affinity variants are detected by quantitating the  $P_{50}$ , the partial pressure of oxygen at which the hemoglobin sample becomes 50% saturated with oxygen. Direct tests for the percent carboxyhemoglobin and methemoglobin, employing spectrophotometric techniques, can readily be obtained from most clinical laboratories on an urgent basis.

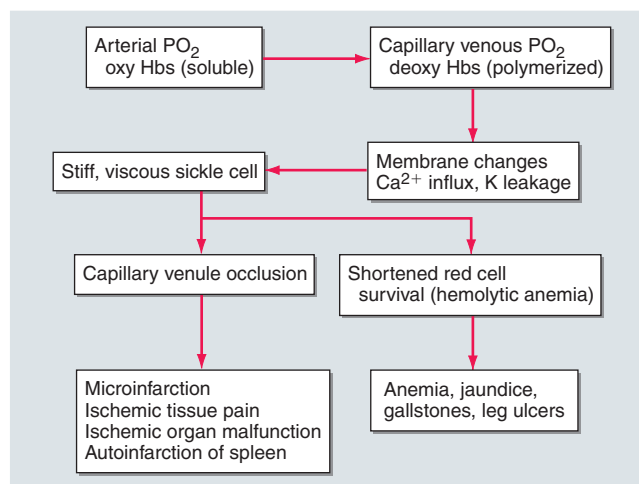
Complete characterization, including amino acid sequencing or gene cloning and sequencing, is available from several investigational laboratories around the world. Polymerase chain reaction (PCR), allele-specific oligonucleotide hybridization, and automated DNA sequencing allow identification of globin gene mutations in a few days.

Laboratory evaluation remains an adjunct, rather than the primary diagnostic aid. Diagnosis is best established by recognition of a characteristic history, physical findings, peripheral blood smear morphology, and abnormalities of the complete blood cell count (e.g., profound microcytosis with minimal anemia in thalassemia trait).

## STRUCTURALLY ABNORMAL HEMOGLOBINS

### SICKLE CELL SYNDROMES

The sickle cell syndromes are caused by a mutation in the  $\beta$ -globin gene that changes the sixth amino acid from glutamic acid to valine. HbS ( $\alpha_2\beta_2^{6 \text{ Glu} \rightarrow \text{Val}}$ ) polymerizes reversibly when deoxygenated to form a gelatinous network of fibrous polymers that stiffen the RBC membrane, increase viscosity, and cause dehydration due to potassium leakage and calcium influx (Fig. 8-3). These changes also produce the sickle shape. Sickled cells lose the pliability needed to traverse small capillaries. They possess altered sticky membranes (especially reticulocytes) that adhere abnormally to the endothelium of



**FIGURE 8-3**  
Pathophysiology of sickle cell crisis.

small venules. These abnormalities provoke unpredictable episodes of microvascular vasoocclusion and premature RBC destruction (hemolytic anemia). Hemolysis occurs because the spleen destroys the abnormal RBC. The rigid adherent cells also clog small capillaries and venules, causing tissue ischemia, acute pain, and gradual end-organ damage. This venoocclusive component usually dominates the clinical course. Prominent manifestations include episodes of ischemic pain (i.e., painful crises) and ischemic malfunction or frank infarction in the spleen, central nervous system, bones, liver, kidneys, and lungs (Fig. 8-3).

Several sickle syndromes occur as the result of inheritance of HbS from one parent and another hemoglobinopathy, such as  $\beta$  thalassemia or HbC ( $\alpha_2\beta_2^{6 \text{ Glu} \rightarrow \text{Lys}}$ ), from the other parent. The prototype disease, sickle cell anemia, is the homozygous state for HbS (Table 8-2).

### Clinical Manifestations of Sickle Cell Anemia

Most patients with sickling syndromes suffer from hemolytic anemia, with hematocrits from 15–30% and significant reticulocytosis. Anemia was once thought to exert protective effects against vasoocclusion by reducing blood viscosity. However, natural history and drug therapy trials suggest that an increase in the hematocrit and feedback inhibition of reticulocytosis might be beneficial, even at the expense of increased blood viscosity. The role of adhesive reticulocytes in vasoocclusion might account for these paradoxical effects.

Granulocytosis is common. The white count can fluctuate substantially and unpredictably during and between painful crises, infectious episodes, and other intercurrent illnesses.

Vasoocclusion causes protean manifestations. Intermittent episodes of vasoocclusion in connective and

**CLINICAL FEATURES OF SICKLE HEMOGLOBINOPATHIES**

CONDITION	CLINICAL ABNORMALITIES	HEMOGLOBIN LEVEL g/L (g/dL)	MCV, fL	HEMOGLOBIN ELECTROPHORESIS
Sickle cell trait	None; rare painless hematuria	Normal	Normal	Hb S/A:40/60
Sickle cell anemia	Vasocclusive crises with infarction of spleen, brain, marrow, kidney, lung; aseptic necrosis of bone; gallstones; priapism; ankle ulcers	70–100 (7–10)	80–100	Hb S/A:100/0 Hb F:2–25%
S/β° thalassemia	Vasocclusive crises; aseptic necrosis of bone	70–100 (7–10)	60–80	Hb S/A:100/0 Hb F:1–10%
S/β+ thalassemia	Rare crises and aseptic necrosis	100–140 (10–14)	70–80	Hb S/A:60/40
Hemoglobin SC	Rare crises and aseptic necrosis; painless hematuria	100–140 (10–14)	80–100	Hb S/A:50/0 Hb C:50%

musculoskeletal structures produce painful ischemia manifested by acute pain and tenderness, fever, tachycardia, and anxiety. These recurrent episodes, called *painful crises*, are the most common clinical manifestation. Their frequency and severity vary greatly. Pain can develop almost anywhere in the body and may last from a few hours to 2 weeks. Repeated crises requiring hospitalization (more than three per year) correlate with reduced survival in adult life, suggesting that these episodes are associated with accumulation of chronic end-organ damage. Provocative factors include infection, fever, excessive exercise, anxiety, abrupt changes in temperature, hypoxia, or hypertonic dyes.

Repeated micro-infarction can destroy tissues having microvascular beds that promote sickling. Thus the spleen is frequently lost within the first 18–36 months of life, causing susceptibility to infection, particularly by pneumococci. Acute venous obstruction of the spleen (*splenic sequestration crisis*), a rare occurrence in early childhood, may require emergency transfusion and/or splenectomy to prevent trapping of the entire arterial output in the obstructed spleen. Occlusion of retinal vessels can produce hemorrhage, neovascularization, and eventual detachments. Renal papillary necrosis invariably produces isosthenuria. More widespread renal necrosis leads to renal failure in adults, a common late cause of death. Bone and joint ischemia can lead to aseptic necrosis, especially of the femoral or humeral heads; chronic arthropathy; and unusual susceptibility to osteomyelitis, which may be caused by organisms such as *Salmonella*, rarely encountered in other settings. The *hand-foot syndrome* is caused by painful infarcts of the digits and dactylitis. Stroke is especially common in children; a small subset tend to suffer repeated episodes. Stroke is less common in adults and is often hemorrhagic. A particularly painful complication in males is priapism, due to infarction of the penile venous outflow tracts; permanent

impotence is a frequent consequence. Chronic lower leg ulcers probably arise from ischemia and superinfection in the distal circulation.

*Acute chest syndrome* is a distinctive manifestation characterized by chest pain, tachypnea, fever, cough, and arterial oxygen desaturation. It can mimic pneumonia, pulmonary emboli, bone marrow infarction and embolism, myocardial ischemia, or in situ lung infarction. Acute chest syndrome is thought to reflect in situ sickling within the lung producing pain and temporary pulmonary dysfunction. Often it is difficult or impossible to distinguish among other possibilities. Pulmonary infarction and pneumonia are the most frequent underlying or concomitant conditions in patients with this syndrome. Repeated episodes of acute chest pain correlate with reduced survival. Acutely, reduction in arterial oxygen saturation is especially ominous because it promotes sickling on a massive scale. Chronic acute or subacute pulmonary crises lead to pulmonary hypertension and cor pulmonale, an increasingly common cause of death as patients survive longer.

Sickle cell syndromes are remarkable for their clinical heterogeneity. Some patients remain virtually asymptomatic into or even through adult life, whereas others suffer repeated crises requiring hospitalization from early childhood. Patients with sickle thalassemia and sickle-HbE tend to have similar, slightly milder, symptoms, perhaps because of the ameliorating effects of production of other hemoglobins within the RBC. Hemoglobin SC disease, one of the more common variants of sickle cell anemia, is frequently marked by lesser degrees of hemolytic anemia and a greater propensity for the development of retinopathy and aseptic necrosis of bones. In most respects, however, the clinical manifestations resemble sickle cell anemia. Some rare hemoglobin variants actually aggravate the sickling phenomenon. The clinical variability in different patients inheriting the same

disease-causing mutation (sickle hemoglobin) has made sickle cell disease the focus of efforts to identify modifying genetic polymorphisms in other genes that might account for the heterogeneity. To date, these genome screening efforts have not yielded modifying genes, other than those known to affect the hemoglobin profile directly: e.g., persistence of fetal hemoglobin in adult life,  $\alpha$  thalassemia, or co-inheritance of other hemoglobin structural variants. The complexity of the data obtained thus far undermines the expectation that genome-wide analysis will yield individualized profiles that predict a patient's clinical course.

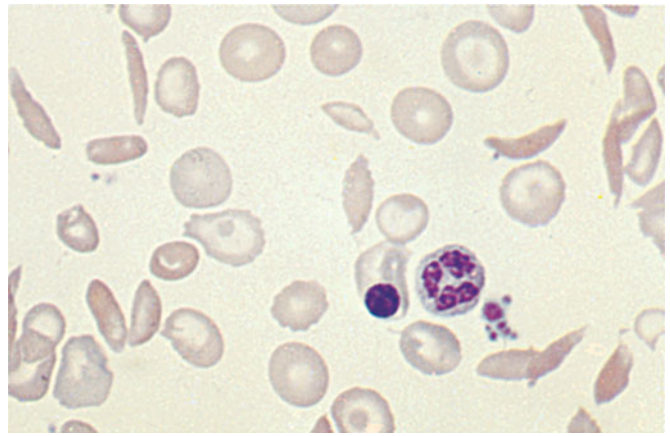
Nevertheless, a number of interesting patterns have emerged from these modifying gene analyses. For example, genes affecting the inflammatory response or cytokine expression appear to be modifying candidates. Genes that affect transcriptional regulation of lymphocytes may be involved. Thus it appears likely that key polymorphic changes in the patient's inflammatory response to the damages provoked by sickle red cells or in the response to chronic or recurrent infections may prove to be important for prognosticating the clinical severity of disease.

### Clinical Manifestations of Sickle Cell Trait

Sickle cell trait is usually asymptomatic. Anemia and painful crises are exceedingly rare. An uncommon but highly distinctive symptom is painless hematuria often occurring in adolescent males, probably due to papillary necrosis. Isosthenuria is a more common manifestation of the same process. Sloughing of papillae with urethral obstruction has been reported, as have isolated cases of massive sickling or sudden death due to exposure to high altitudes or extremes of exercise and dehydration.

### Diagnosis

Sickle cell syndromes are suspected on the basis of hemolytic anemia, RBC morphology (Fig. 8-4), and intermittent episodes of ischemic pain. Diagnosis is confirmed by hemoglobin electrophoresis and the sickling tests already discussed. Thorough characterization of the exact hemoglobin profile of the patient is important because sickle thalassemia and hemoglobin SC disease have distinct prognoses or clinical features. Diagnosis is usually established in childhood, but occasional patients, often with compound heterozygous states, do not develop symptoms until the onset of puberty, pregnancy, or early adult life. Genotyping of family members and potential parental partners is critical for genetic counseling. Details of the childhood history establish prognosis and need for aggressive or experimental therapies. Factors associated with increased morbidity and reduced survival are more than three crises requiring hospitalization per year, chronic neutrophilia, a history of splenic



**FIGURE 8-4**

**Sickle cell anemia.** The elongated and crescent-shaped red blood cells seen on this smear represent circulating irreversibly sickled cells. Target cells and a nucleated red blood cell are also seen.

sequestration or hand-foot syndrome, and second episodes of acute chest syndrome. Patients with a history of cerebrovascular accidents are at higher risk for repeated episodes and require especially close monitoring using Doppler carotid flow measurements. Patients with severe or repeated episodes of acute chest syndrome may need lifelong transfusion support, using partial exchange transfusion, if possible.

### **Rx** Treatment: SICKLE CELL SYNDROMES

Patients with sickle cell syndromes require ongoing continuity of care. Familiarity with the pattern of symptoms provides the best safeguard against excessive use of the emergency department, hospitalization, and habituation to addictive narcotics. Additional preventive measures include regular slit-lamp examinations to monitor development of retinopathy; antibiotic prophylaxis appropriate for splenectomized patients during dental or other invasive procedures; and vigorous oral hydration during or in anticipation of periods of extreme exercise, exposure to heat or cold, emotional stress, or infection. Pneumococcal and *Haemophilus influenzae* vaccines are less effective in splenectomized individuals. Thus patients with sickle cell anemia should be vaccinated early in life.

The management of acute painful crisis includes vigorous hydration, thorough evaluation for underlying causes (such as infection), and aggressive analgesia administered by a standing order and/or patient-controlled analgesia (PCA) pump. Morphine (0.1–0.15 mg/kg every 3–4 h) or meperidine (0.75–1.5 mg/kg every 2–4 h)



should control severe pain. Meperidine should be used only for acute short-term pain control; as a chronic analgesic, it is unsuitable. Bone pain may respond as well to ketorolac (30–60 mg initial dose, then 15–30 mg every 6–8 h). Inhalation of nitrous oxide can provide short-term pain relief, but great care must be exercised to avoid hypoxia and respiratory depression. Nitrous oxide also elevates O<sub>2</sub> affinity, reducing O<sub>2</sub> delivery to tissues. Its use should be restricted to experts. Many crises can be managed at home with oral hydration and oral analgesia. Use of the emergency department should be reserved for especially severe symptoms or circumstances in which other processes, e.g., infection, are strongly suspected. Nasal oxygen should be employed as appropriate to protect arterial saturation. Most crises resolve in 1–7 days. Use of blood transfusion should be reserved for extreme cases: transfusions do not shorten the duration of the crisis.

No tests are definitive to diagnose acute painful crisis. Critical to good management is an approach that recognizes most patients reporting crisis symptoms do indeed have a crisis or another significant medical problem. Diligent diagnostic evaluation for underlying causes is imperative, even though these are found infrequently. In adults, the possibility of aseptic necrosis or sickle arthropathy must be considered, especially if pain and immobility become repeated or chronic at a single site. Nonsteroidal anti-inflammatory agents are often effective for sickle cell arthropathy.

Acute chest syndrome is a medical emergency that may require management in an intensive care unit. Hydration should be monitored carefully to avoid the development of pulmonary edema, and O<sub>2</sub> therapy should be especially vigorous for protection of arterial saturation. Diagnostic evaluation for pneumonia and pulmonary embolism should be especially thorough because these may occur with atypical symptoms. Critical interventions are transfusion to maintain a hematocrit >30, and emergency exchange transfusion if arterial saturation drops to <90%. As patients with sickle cell syndrome increasingly survive into their fifth and sixth decades, end-stage renal failure and pulmonary hypertension are becoming increasingly prominent causes of end-stage morbidity. A sickle cell cardiomyopathy and/or premature coronary artery disease may compromise cardiac function in later years. Sick cell patients have received kidney transplants, but they often experience an increase in the frequency and severity of crises, possibly due to increased infection as a consequence of immunosuppression.

The most significant advance in the therapy of sickle cell anemia has been the introduction of hydroxyurea as a mainstay of therapy for patients with severe symptoms. Hydroxyurea (10–30 mg/kg per day) increases fetal hemoglobin and may also exert beneficial effects

on RBC hydration, vascular wall adherence, and suppression of the granulocyte and reticulocyte counts; dosage is titrated to maintain a white cell count between 5000 and 8000 per  $\mu\text{L}$ . White cells and reticulocytes may play a major role in the pathogenesis of sickle cell crisis, and their suppression may be an important benefit of hydroxyurea therapy.

Hydroxyurea should be considered in patients experiencing repeated episodes of acute chest syndrome or with more than three crises per year requiring hospitalization. The usefulness of this agent for reducing the incidence of other complications (priapism, retinopathy) is under evaluation, as are the long-term side effects. Hydroxyurea offers broad benefits to most patients whose disease is severe enough to impair their functional status, and it may improve survival. HbF levels increase in most patients within a few months.

The antitumor drug 5-azacytidine was the first agent found to elevate HbF. It never achieved widespread use because of concerns about acute toxicity and carcinogenesis. However, low doses of the related agent 5-deoxyazacytidine (decitabine) can elevate HbF with acceptable toxicity.

Bone marrow transplantation can provide definitive cures but is known to be effective and safe only in children. Prognostic features justifying bone marrow transplant are the presence of repeated crises early in life, a high neutrophil count, or the development of hand-foot syndrome. Children at risk for stroke can now be identified through the use of Doppler ultrasound techniques. Prophylactic exchange transfusion appears to reduce the risk of stroke substantially in this population. Children who do suffer a cerebrovascular accident should be maintained for at least 3–5 years on a program of vigorous exchange transfusion because the risk of second strokes is extremely high.

Gene therapy for sickle cell anemia is being intensively pursued, but no safe measures are currently available. Agents blocking RBC dehydration or vascular adhesion, such as clotrimazole or magnesium, may have value as an adjunct to hydroxyurea therapy, pending the completion of ongoing trials. Combinations of clotrimazole and magnesium are being evaluated.

## UNSTABLE HEMOGLOBINS

Amino acid substitutions that reduce solubility or increase susceptibility to oxidation produce unstable hemoglobins that precipitate, forming inclusion bodies injurious to the RBC membrane. Representative mutations are those that interfere with contact points between the  $\alpha$  and  $\beta$  subunits [e.g., Hb Philly ( $\beta^{35\text{Tyr}\rightarrow\text{Phe}}$ )], alter the helical segments [e.g., Hb Genova ( $\beta^{28\text{Leu}\rightarrow\text{Pro}}$ )], or disrupt

TABLE 8-3

## REPRESENTATIVE ABNORMAL HEMOGLOBINS WITH ALTERED SYNTHESIS OR FUNCTION

DESIGNATION	MUTATION	POPULATION	MAIN CLINICAL EFFECTS <sup>a</sup>
Sickle or S	$\beta^{6\text{Glu}\rightarrow\text{Val}}$	African	Anemia, ischemic infarcts
C	$\beta^{6\text{Glu}\rightarrow\text{Lys}}$	African	Mild anemia; interacts with HbS
E	$\beta^{26\text{Glu}\rightarrow\text{Lys}}$	Southeast Asian	Microcytic anemia, splenomegaly, thalassemic phenotype
Köln	$\beta^{98\text{Val}\rightarrow\text{Met}}$	Sporadic	Hemolytic anemia, Heinz bodies when splenectomized
Yakima	$\beta^{99\text{Asp}\rightarrow\text{His}}$	Sporadic	Polycythemia
Kansas	$\beta^{102\text{Asn}\rightarrow\text{Lys}}$	Sporadic	Mild anemia
M. Iwata	$\alpha^{87\text{His}\rightarrow\text{Tyr}}$	Sporadic	Methemoglobinemia

<sup>a</sup>See text for details.

interactions of the hydrophobic pockets of the globin subunits with heme [e.g., Hb Köln ( $\beta^{98\text{Val}\rightarrow\text{Met}}$ )] (Table 8-3). The inclusions, called *Heinz bodies*, are clinically detectable by staining with supravital dyes such as crystal violet. Removal of these inclusions by the spleen generates pitted, rigid cells that have shortened life spans, producing hemolytic anemia of variable severity, sometimes requiring chronic transfusion support. Splenectomy may be needed to correct the anemia. Leg ulcers and premature gallbladder disease due to bilirubin load are frequent stigmata.

Unstable hemoglobins occur sporadically, often by spontaneous new mutations. Heterozygotes are often symptomatic because a significant Heinz body burden can develop even when the unstable variant accounts for a portion of the total hemoglobin. Symptomatic unstable hemoglobins tend to be  $\beta$ -globin variants because sporadic mutations affecting only one of the four  $\alpha$  globins would generate only 20–30% abnormal hemoglobin.

## HEMOGLOBINS WITH ALTERED OXYGEN AFFINITY

*High-affinity hemoglobins* [e.g., Hb Yakima ( $\beta^{99\text{Asp}\rightarrow\text{His}}$ )] bind oxygen more readily but deliver less O<sub>2</sub> to tissues at normal capillary P<sub>O<sub>2</sub></sub> levels (Fig. 8-2). Mild tissue hypoxia ensues, stimulating RBC production and erythrocytosis (Table 8-3). In extreme cases, the hematocrits can rise to 60–65%, increasing blood viscosity and producing typical symptoms (headache, somnolence, or dizziness). Phlebotomy may be required. Typical mutations alter interactions within the heme pocket or disrupt the Bohr effect or salt-bond site. Mutations that impair the interaction of HbA with 2,3-BPG can increase O<sub>2</sub> affinity because 2,3-BPG binding lowers O<sub>2</sub> affinity.

*Low-affinity hemoglobins* [e.g., Hb Kansas ( $\beta^{102\text{Asn}\rightarrow\text{Lys}}$ )] bind sufficient oxygen in the lungs, despite their lower oxygen affinity, to achieve nearly full saturation. At

capillary oxygen tensions, they lose sufficient amounts of oxygen to maintain homeostasis at a low hematocrit (Fig. 8-2) (*pseudoanemia*). Capillary hemoglobin desaturation can also be sufficient to produce clinically apparent cyanosis. Despite these findings, patients usually require no specific treatment.

## METHEMOGLOBINEMIAS

Methemoglobin is generated by oxidation of the heme iron moieties to the ferric state, causing a characteristic bluish brown muddy color resembling cyanosis. Methemoglobin has such high oxygen affinity that virtually no oxygen is delivered. Levels >50–60% are often fatal.

Congenital methemoglobinemia arises from globin mutations that stabilize iron in the ferric state [e.g., HbM Iwata ( $\alpha^{87\text{His}\rightarrow\text{Tyr}}$ ), Table 8-3] or from mutations that impair the enzymes that reduce methemoglobin to hemoglobin (e.g., methemoglobin reductase, NADP diaphorase). Acquired methemoglobinemia is caused by toxins that oxidize heme iron, notably nitrate and nitrite-containing compounds.

## DIAGNOSIS AND MANAGEMENT OF PATIENTS WITH UNSTABLE HEMOGLOBINS, HIGH-AFFINITY HEMOGLOBINS, AND METHEMOGLOBINEMIA

*Unstable hemoglobin variants* should be suspected in patients with nonimmune hemolytic anemia, jaundice, splenomegaly, or premature biliary tract disease. Severe hemolysis usually presents during infancy as neonatal jaundice or anemia. Milder cases may present in adult life with anemia or only as unexplained reticulocytosis, hepatosplenomegaly, premature biliary tract disease, or leg ulcers. Because spontaneous mutation is common, family history of anemia may be absent. The peripheral blood smear often shows anisocytosis, abundant cells

90 with punctate inclusions, and irregular shapes (i.e., poikilocytosis).

The two best tests for diagnosing unstable hemoglobins are the Heinz body preparation and the isopropanol or heat stability test. Many unstable Hb variants are electrophoretically silent. A normal electrophoresis does not rule out the diagnosis.

Severely affected patients may require transfusion support for the first 3 years of life because splenectomy before age 3 is associated with a significantly higher immune deficit. Splenectomy is usually effective thereafter, but occasional patients may require lifelong transfusion support. Even after splenectomy, patients can develop cholelithiasis and leg ulcers. Splenectomy can also be considered in patients exhibiting severe secondary complications of chronic hemolysis, even if anemia is absent. Precipitation of unstable hemoglobins is aggravated by oxidative stress, e.g., infection, antimalarial drugs.

*High-O<sub>2</sub> affinity hemoglobin variants* should be suspected in patients with erythrocytosis. The best test for confirmation is measurement of the P<sub>50</sub>. A high-O<sub>2</sub> affinity Hb causes a significant left shift (i.e., lower numeric value of the P<sub>50</sub>); confounding conditions, e.g., tobacco smoking or carbon monoxide exposure, can also lower the P<sub>50</sub>.

High-affinity hemoglobins are often asymptomatic; rubor or plethora may be telltale signs. When the hematocrit reaches 55–60%, symptoms of high blood viscosity and sluggish flow (headache, lethargy, dizziness, etc.) may be present. These persons may benefit from judicious phlebotomy. Erythrocytosis represents an appropriate attempt to compensate for the impaired oxygen delivery by the abnormal variant. Overzealous phlebotomy may stimulate increased erythropoiesis or aggravate symptoms by thwarting this compensatory mechanism. The guiding principle of phlebotomy should be to improve oxygen delivery by reducing blood viscosity and increasing blood flow rather than restoration of a normal hematocrit. Modest iron deficiency may aid in control.

*Low-affinity hemoglobins* should be considered in patients with cyanosis or a low hematocrit with no other reason apparent after thorough evaluation. The P<sub>50</sub> test confirms the diagnosis. Counseling and reassurance are the interventions of choice.

*Methemoglobin* should be suspected in patients with hypoxic symptoms who appear cyanotic but have a PaO<sub>2</sub> sufficiently high that hemoglobin should be fully saturated with oxygen. A history of nitrite or other oxidant ingestions may not always be available; some exposures may be unapparent to the patient, and others may result from suicide attempts. The characteristic muddy appearance of freshly drawn blood can be a critical clue. The best diagnostic test is methemoglobin assay, which is usually available on an emergency basis.

Methemoglobinemia often causes symptoms of cerebral ischemia at levels >15%; levels >60% are usually

lethal. Intravenous injection of 1 mg/kg of methylene blue is effective emergency therapy. Milder cases and follow-up of severe cases can be treated orally with methylene blue (60 mg three to four times each day) or ascorbic acid (300–600 mg/d).

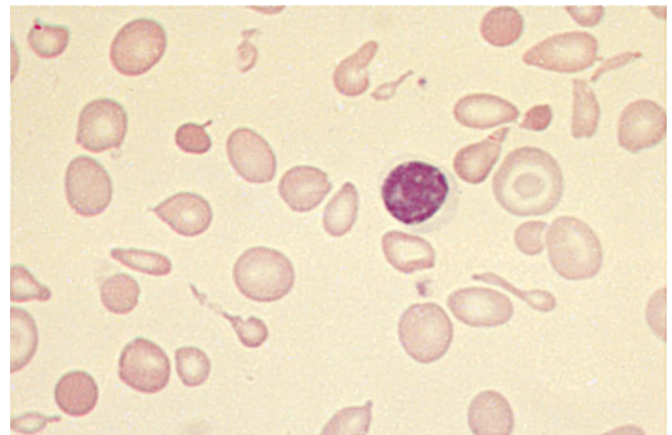
## THALASSEMIA SYNDROMES

The thalassemia syndromes are inherited disorders of  $\alpha$ - or  $\beta$ -globin biosynthesis. The reduced supply of globin diminishes production of hemoglobin tetramers, causing hypochromia and microcytosis. Unbalanced accumulation of  $\alpha$  and  $\beta$  subunits occurs because the synthesis of the unaffected globins proceeds at a normal rate. Unbalanced chain accumulation dominates the clinical phenotype. Clinical severity varies widely, depending on the degree to which the synthesis of the affected globin is impaired, altered synthesis of other globin chains, and co-inheritance of other abnormal globin alleles.

### CLINICAL MANIFESTATIONS OF $\beta$ -THALASSEMIA SYNDROMES

Mutations causing thalassemia can affect any step in the pathway of globin gene expression: transcription, processing of the mRNA precursor, translation, and post-translational metabolism of the  $\beta$ -globin polypeptide chain. The most common forms arise from mutations that derange splicing of the mRNA precursor or prematurely terminate translation of the mRNA.

Hypochromia and microcytosis characterize all forms of  $\beta$  thalassemia because of the reduced amounts of hemoglobin tetramers (Fig. 8-5). In heterozygotes ( $\beta$ -thalassemia trait), this is the only abnormality seen. Anemia is minimal. In more severe homozygous states,



**FIGURE 8-5**

**$\beta$ -Thalassemia intermedia.** Microcytic and hypochromic red blood cells are seen that resemble the red blood cells of severe iron-deficiency anemia. Many elliptical and teardrop-shaped red blood cells are noted.

unbalanced  $\alpha$ - and  $\beta$ -globin accumulation causes accumulation of highly insoluble unpaired  $\alpha$  chains. They form toxic inclusion bodies that kill developing erythroblasts in the marrow. Few of the proerythroblasts beginning erythroid maturation survive. The few resulting RBCs bear a burden of inclusion bodies that are detected in the spleen, shortening the RBC life span and producing severe hemolytic anemia. The resulting profound anemia stimulates erythropoietin release and compensatory erythroid hyperplasia, but the marrow response is sabotaged by ineffective erythropoiesis. Anemia persists. Erythroid hyperplasia can become exuberant and produce masses of extramedullary erythropoietic tissue in the liver and spleen.

Massive bone marrow expansion deranges growth and development. Children develop characteristic “chipmunk” facies due to maxillary marrow hyperplasia and frontal bossing. Thinning and pathologic fracture of long bones and vertebrae may occur due to cortical invasion by erythroid elements and profound growth retardation. Hemolytic anemia causes hepatosplenomegaly, leg ulcers, gallstones, and high-output congestive heart failure. The conscription of caloric resources to support erythropoiesis leads to inanition, susceptibility to infection, endocrine dysfunction, and, in the most severe cases, death during the first decade of life. Chronic transfusions with RBCs improves oxygen delivery, suppresses the excessive ineffective erythropoiesis, and prolongs life, but the inevitable side effects, notably iron overload, usually prove fatal by age 30.

Severity is highly variable. Known modulating factors are those that ameliorate the burden of unpaired  $\alpha$ -globin inclusions. Alleles associated with milder synthetic defects and co-inheritance of  $\alpha$ -thalassemia trait reduce clinical severity by reducing accumulation of excess  $\alpha$  globin. HbF persists to various degrees in  $\beta$  thalassemias.  $\gamma$ -Globin

gene chains can substitute for  $\beta$  chains, generating more hemoglobin and reducing the burden of  $\alpha$ -globin inclusions. The terms  $\beta$ -thalassemia major and  $\beta$ -thalassemia intermedia are used to reflect the clinical heterogeneity. Patients with  $\beta$ -thalassemia major require intensive transfusion support to survive. Patients with  $\beta$ -thalassemia intermedia have a somewhat milder phenotype and can survive without transfusion. The terms  $\beta$ -thalassemia minor and  $\beta$ -thalassemia trait describe asymptomatic heterozygotes for  $\beta$  thalassemia.

## $\alpha$ -THALASSEMIA SYNDROMES

The four classic  $\alpha$  thalassemias, most common in Asians, are  $\alpha$ -thalassemia-2 trait, in which one of the four  $\alpha$ -globin loci is deleted;  $\alpha$ -thalassemia-1 trait, with two deleted loci; HbH disease, with three loci deleted; and hydrops fetalis with Hb Bart's, with all four loci deleted (Table 8-4). Nondeletion forms of  $\alpha$  thalassemia also exist.

$\alpha$ -Thalassemia-2 trait is an asymptomatic, silent carrier state.  $\alpha$ -Thalassemia-1 trait resembles  $\beta$ -thalassemia minor. Offspring doubly heterozygous for  $\alpha$ -thalassemia-2 and  $\alpha$ -thalassemia-1 exhibit a more severe phenotype called HbH disease. Heterozygosity for a deletion that removes both genes from the same chromosome (*cis* deletion) is common in Asians and in those from the Mediterranean region, as is homozygosity for  $\alpha$ -thalassemia-2 (*trans* deletion). Both produce asymptomatic hypochromia and microcytosis.

In HbH disease, HbA production is only 25–30% normal. Fetuses accumulate some unpaired  $\beta$  chains. In adults, unpaired  $\beta$  chains accumulate and are soluble enough to form  $\beta_4$  tetramers called HbH. HbH forms few inclusions in erythroblasts and precipitates in circulating RBC. Patients with HbH disease have thalassemia intermedia characterized by moderately severe hemolytic

TABLE 8-4

### THE $\alpha$ THALASSEMIAS

CONDITION	HEMOGLOBIN A, %	HEMOGLOBIN H ( $\beta^4$ ), %	HEMOGLOBIN LEVEL, g/L (g/dL)	MCV, fL
Normal	97	0	150 (15)	90
Silent thalassemia: $-\alpha/\alpha$	98–100	0	150 (15)	90
Thalassemia trait:				
$-\alpha/-\alpha$ homozygous $\alpha$ -thal-2 <sup>a</sup>	85–95	Rare red blood cell inclusions	120–130 (12–13)	70–80
or				
$-/\alpha\alpha$ heterozygous $\alpha$ -thal-1 <sup>a</sup>				
Hemoglobin H disease:	70–95	5–30	60–100 (6–10)	60–70
$-/-\alpha$ heterozygous $\alpha$ -thal-1/ $\alpha$ -thal-2				
Hydrops fetalis:	0	5–10 <sup>b</sup>	Fatal in utero or at birth	
$-/-/-$ homozygous $\alpha$ -thal-1				

<sup>a</sup>When both  $\alpha$  alleles on one chromosome are deleted, the locus is called  $\alpha$ -thal-1; when only a single  $\alpha$  allele on one chromosome is deleted, the locus is called  $\alpha$ -thal-2.

<sup>b</sup>90–95% of the hemoglobin is hemoglobin Barts (tetramers of  $\gamma$  chains).

92 anemia but milder ineffective erythropoiesis. Survival into mid-adult life without transfusions is common.

The homozygous state for the  $\alpha$ -thalassemia-1 *cis* deletion (hydrops fetalis) causes total absence of  $\alpha$ -globin synthesis. No physiologically useful hemoglobin is produced beyond the embryonic stage. Excess  $\gamma$  globin forms tetramers called *Hb Barts* ( $\gamma_4$ ), which has a very high oxygen affinity. It delivers almost no  $O_2$  to fetal tissues, causing tissue asphyxia, edema (hydrops fetalis), congestive heart failure, and death in utero.  $\alpha$ -Thalassemia-2 trait is common (15–20%) among people of African descent. The *cis*  $\alpha$ -thalassemia-1 deletion is almost never seen, however. Thus  $\alpha$ -thalassemia-2 and the *trans* form of  $\alpha$ -thalassemia-1 are very common, but HbH disease and hydrops fetalis are almost never encountered.

It has been known for some time that some patients with myelodysplasia or erythroleukemia produce RBC clones containing HbH. This phenomenon is due to mutations in the ATRX pathway that affect the LCR of the  $\alpha$ -globin gene cluster.

## DIAGNOSIS AND MANAGEMENT OF THALASSEMIAS

The diagnosis of  $\beta$ -thalassemia major is readily made during childhood on the basis of severe anemia accompanied by the characteristic signs of massive ineffective erythropoiesis: hepatosplenomegaly, profound microcytosis, a characteristic blood smear (Fig. 8-5), and elevated levels of HbF, HbA<sub>2</sub>, or both. Many patients require chronic hypertransfusion therapy designed to maintain a hematocrit of at least 27–30% so that erythropoiesis is suppressed. Splenectomy is required if the annual transfusion requirement (volume of RBCs per kilogram of body weight per year) increases by >50%. Folic acid supplements may be useful. Vaccination with Pneumovax in anticipation of eventual splenectomy is advised, as is close monitoring for infection, leg ulcers, and biliary tract disease. Many patients develop endocrine deficiencies as a result of iron overload. Early endocrine evaluation is required for glucose intolerance, thyroid dysfunction, and delayed onset of puberty or secondary sexual characteristics.

Patients with  $\beta$ -thalassemia intermedia exhibit similar stigmata but can survive without chronic hypertransfusion. Management is particularly challenging because a number of factors can aggravate the anemia, including infection, onset of puberty, and development of splenomegaly and hypersplenism. Some patients may eventually benefit from splenectomy. The expanded erythron can cause absorption of excessive dietary iron and hemosiderosis, even without transfusion.

$\beta$ -Thalassemia minor (i.e., thalassemia trait) usually presents as profound microcytosis and hypochromia with target cells but only minimal or mild anemia. The

mean corpuscular volume is rarely >75 fL; the hematocrit is rarely <30–33%. Hemoglobin electrophoresis classically reveals an elevated HbA<sub>2</sub> (3.5–7.5%), but some forms are associated with normal HbA<sub>2</sub> and/or elevated HbF. Genetic counseling and patient education are essential. Patients with  $\beta$ -thalassemia trait should be warned that their blood picture resembles iron deficiency and can be misdiagnosed. They should eschew empirical use of iron; yet iron deficiency can develop during pregnancy or from chronic bleeding.

Persons with  $\alpha$ -thalassemia trait may exhibit mild hypochromia and microcytosis usually without anemia. HbA<sub>2</sub> and HbF levels are normal. Affected individuals usually require only genetic counseling. HbH disease resembles  $\beta$ -thalassemia intermedia, with the added complication that the HbH molecule behaves like moderately unstable hemoglobin. Patients with HbH disease should undergo splenectomy if excessive anemia or a transfusion requirement develops. Oxidative drugs should be avoided. Iron overload leading to death can occur in more severely affected patients.

## PREVENTION

Antenatal diagnosis of thalassemia syndromes is now widely available. DNA diagnosis is based on PCR amplification of fetal DNA, obtained by amniocentesis or chorionic villus biopsy followed by hybridization to allele-specific oligonucleotides probes. The probes can be designed to detect simultaneously the subset of mutations that account for 95–99% of the  $\alpha$ - or  $\beta$ -thalassemias that occur in a particular group.

## THALASSEMIC STRUCTURAL VARIANTS

Thalassemic structural variants are characterized by both defective synthesis and abnormal structure.

## HEMOGLOBIN LEPORE

Hb Lepore [ $\alpha_2(\delta\beta)_2$ ] arises by an unequal crossover and recombination event that fuses the proximal end of the  $\delta$ -gene with the distal end of the closely linked  $\beta$  gene. The resulting chromosome contains only the fused  $\delta\beta$  gene. The Lepore ( $\delta\beta$ ) globin is synthesized poorly because the fused gene is under the control of the weak  $\delta$ -globin promoter. Hb Lepore alleles have a phenotype like  $\beta$  thalassemia, except for the added presence of 2–20% Hb Lepore. Compound heterozygotes for Hb Lepore and a classic  $\beta$ -thalassemia allele may also have severe thalassemia.

## HEMOGLOBIN E



HbE (i.e.,  $\alpha_2\beta_2^{26\text{Glu}\rightarrow\text{Lys}}$ ) is extremely common in Cambodia, Thailand, and Vietnam. The gene has become far more prevalent in the United States as a

result of immigration of Asian persons, especially in California, where HbE is the most common variant detected. HbE is mildly unstable but not enough to affect RBC life span significantly. The high frequency of the HbE gene may be a result of the thalassemia phenotype associated with its inheritance. Heterozygotes resemble individuals with mild  $\beta$ -thalassemia trait. Homozygotes have somewhat more marked abnormalities but are asymptomatic. Compound heterozygotes for HbE and a  $\beta$ -thalassemia gene can have  $\beta$ -thalassemia intermedia or  $\beta$ -thalassemia major, depending on the severity of the co-inherited thalassemic gene.

The  $\beta^E$  allele contains a single base change in codon 26 that causes the amino acid substitution. However, this mutation activates a cryptic RNA splice site generating a structurally abnormal globin mRNA that cannot be translated from ~50% of the initial pre-mRNA molecules. The remaining 40–50% are normally spliced and generate functional mRNA that is translated into  $\beta^E$ -globin because the mature mRNA carries the base change that alters codon 26.

Genetic counseling of the persons at risk for HbE should focus on the interaction of HbE with  $\beta$  thalassemia rather than HbE homozygosity, a condition associated with asymptomatic microcytosis, hypochromia, and hemoglobin levels rarely  $<100$  g/L ( $<10$  g/dL).

### HEREDITARY PERSISTENCE OF FETAL HEMOGLOBIN

HPFH is characterized by continued synthesis of high levels of HbF in adult life. No deleterious effects are apparent, even when all of the hemoglobin produced is HbF. These rare patients demonstrate convincingly that prevention or reversal of the fetal to adult hemoglobin switch would provide effective therapy for sickle cell anemia and  $\beta$  thalassemia.

### ACQUIRED HEMOGLOBINOPATHIES

The two most important acquired hemoglobinopathies are carbon monoxide poisoning and methemoglobinemia (see earlier). Carbon monoxide has a higher affinity for hemoglobin than does oxygen; it can replace oxygen and diminish  $O_2$  delivery. Chronic elevation of carboxyhemoglobin levels to 10 or 15%, as occurs in smokers, can lead to secondary polycythemia. Carboxyhemoglobin is cherry red in color and masks the development of cyanosis usually associated with poor  $O_2$  delivery to tissues.

Abnormalities of hemoglobin biosynthesis have also been described in blood dyscrasias. In some patients with myelodysplasia, erythroleukemia, or myeloproliferative disorders, a mild form of HbH disease may also be seen. The abnormalities are not severe enough to alter the course of the underlying disease.

### Rx Treatment: TRANSFUSIONAL HEMOSIDEROSIS

Chronic blood transfusion can lead to blood-borne infection, alloimmunization, febrile reactions, and lethal iron overload (Chap. 12). A unit of packed RBCs contains 250–300 mg iron (1 mg/mL). The iron assimilated by a single transfusion of two units of packed RBCs is thus equal to a 1- to 2-year intake of iron. Iron accumulates in chronically transfused patients because no mechanisms exist for increasing iron excretion: an expanded erythron causes especially rapid development of iron overload because accelerated erythropoiesis promotes excessive absorption of dietary iron. Vitamin C should not be supplemented because it generates free radicals in iron excess states.

Patients who receive  $>100$  units of packed RBCs usually develop hemosiderosis. The ferritin level rises, followed by early endocrine dysfunction (glucose intolerance and delayed puberty), cirrhosis, and cardiomyopathy. Liver biopsy shows both parenchymal and reticuloendothelial iron. The superconducting quantum interference device (SQUID) is accurate at measuring hepatic iron but not widely available. Cardiac toxicity is often insidious. Early development of pericarditis is followed by dysrhythmia and pump failure. The onset of heart failure is ominous, often presaging death within a year.

The decision to start long-term transfusion support should also prompt one to institute therapy with iron-chelating agents. Deferoxamine (Desferal) is for parenteral use. Its iron-binding kinetics require chronic slow infusion via a metering pump. The constant presence of the drug improves the efficiency of chelation and protects tissues from occasional releases of the most toxic fraction of iron—low-molecular-weight iron—which may not be sequestered by protective proteins.

Deferoxamine is relatively nontoxic. Occasional cataracts, deafness, and local skin reactions, including urticaria, occur. Skin reactions can usually be managed with antihistamines. Negative iron balance can be achieved, even in the face of a high transfusion requirement, but this alone does not prevent long-term morbidity and mortality in chronically transfused patients. Irreversible end-organ deterioration develops at relatively modest levels of iron overload, even if symptoms do not appear for many years thereafter. To enjoy a significant survival advantage, chelation must begin before 5–8 years of age in  $\beta$ -thalassemia major.

Deferasirox is a promising oral iron-chelating agent. Single daily doses of 20 or 30 mg/kg deferasirox produced reductions in liver iron concentration comparable to deferoxamine in chronically transfused adult and pediatric patients. Deferasirox produces some elevations in liver enzymes and slight but persistent increases in serum creatinine, without apparent clinical consequence. Other toxicities are similar to those of deferoxamine. Its toxicity profile is acceptable, although long-term effects are still being evaluated.

## BONE MARROW TRANSPLANTATION, GENE THERAPY, AND MANIPULATION OF HbF

Bone marrow transplantation provides stem cells able to express normal hemoglobin; it has been used in a large number of patients with  $\beta$  thalassemia and a smaller number of patients with sickle cell anemia. Early in the course of disease, before end-organ damage occurs, transplantation is curative in 80–90% of patients. In highly experienced centers, the treatment-related mortality is <10%. Because survival into adult life is possible with conventional therapy, the decision to transplant is best made in consultation with specialized centers.

Gene therapy of thalassemia and sickle cell disease has proved to be an elusive goal. Uptake of gene vectors into the nondividing hematopoietic stem cells has been inefficient. Lentiviral-type vectors that can transduce nondividing cells may solve this problem.

Reestablishing high levels of fetal hemoglobin synthesis should ameliorate the symptoms of  $\beta$  thalassemia. Cytotoxic agents such as hydroxyurea and cytarabine promote high levels of HbF synthesis, probably by stimulating proliferation of the primitive HbF-producing progenitor cell population (i.e., F cell progenitors). Unfortunately, no regimen has yet been identified that ameliorates the clinical manifestations of  $\beta$  thalassemia. Butyrates stimulate HbF production but only transiently. Pulsed or intermittent administration has been found to sustain HbF induction in most patients with sickle cell disease. It is unclear whether butyrates will have similar activity in patients with  $\beta$  thalassemia.

## APLASTIC AND HYPOPLASTIC CRISIS IN PATIENTS WITH HEMOGLOBINOPATHIES

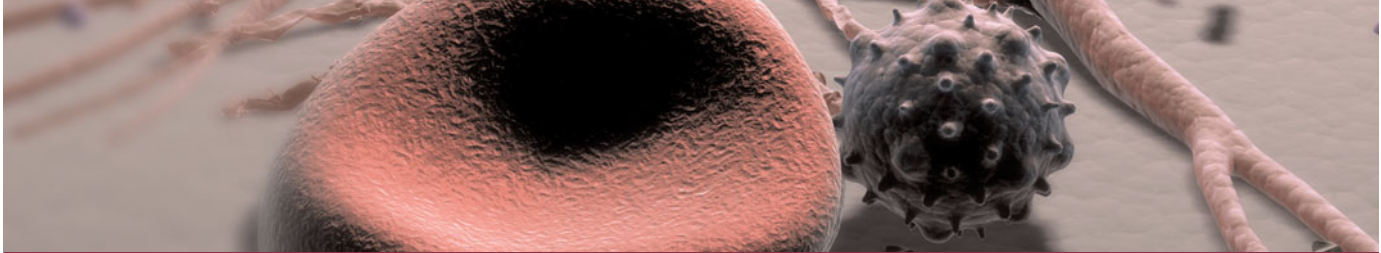
Patients with hemolytic anemias sometimes exhibit an alarming decline in hematocrit during and immediately after acute illnesses. Bone marrow suppression occurs in almost everyone during acute inflammatory illnesses. In

patients with short RBC life spans, suppression can affect RBC counts more dramatically. These hypoplastic crises are usually transient and self-correcting before intervention is required.

*Aplastic crisis* refers to a profound cessation of erythroid activity in patients with chronic hemolytic anemias. It is associated with a rapidly falling hematocrit. Episodes are usually self-limited. Aplastic crises are caused by infection with a particular strain of parvovirus, B19A. Children infected with this virus usually develop permanent immunity. Aplastic crises do not often recur and are rarely seen in adults. Management requires close monitoring of the hematocrit and reticulocyte count. If anemia becomes symptomatic, transfusion support is indicated. Most crises resolve spontaneously within 1–2 weeks.

## FURTHER READINGS

- ATAGA KI, ORRINGA EP: Hypercoagulability in sickle cell disease: A curious paradox. *Am J Med* 115:721, 2003
- DESIMONE J et al: Maintenance of elevated fetal hemoglobin levels by decitabine during dose interval treatment of sickle cell anemia. *Blood* 99:3905, 2002
- MAGGIO A et al: Long-term sequential deferiprone-deferoxamine versus deferiprone alone for thalassemia major patients: A randomized clinical trial. *Br J Haematol* 145:245, 2009
- NEUFELD EJ: Oral chelators deferasirox and deferiprone for transfusional iron overload in thalassemia major: New data, new questions. *Blood* 107:3436, 2006
- NISCOLA P et al: Pain syndromes in sickle cell disease: An update. *Pain Med* 10:470, 2009
- QUEK L, THEIN SL: Molecular therapies in beta-thalassaemia. *Br J Haematol* 136:353, 2007
- SANKARAN VG et al: Developmental and species-divergent globin switching are driven by BCL11A. *Nature* 460:1093, 2009
- STEINBERG MH: Pathophysiologically based drug treatment of sickle cell disease. *Trends Pharmacol Sci* 27:204, 2006
- SWITZER JA et al: Pathophysiology and treatment of stroke in sickle-cell disease: Present and future. *Lancet Neurol* 5:501, 2006
- TSARAS G et al: Complications associated with sickle cell trait: A brief narrative review. *Am J Med* 122:507, 2009
- WARE RE et al: Predictors of fetal hemoglobin response in children with sickle cell anemia receiving hydroxyurea therapy. *Blood* 99:10, 2002



## CHAPTER 9

# MEGALOBLASTIC ANEMIAS

A. Victor Hoffbrand

■ Cobalamin	95
■ Folate	96
■ Biochemical Basis of Megaloblastic Anemia	98
■ Clinical Features	99
■ Hematologic Findings	100
■ Causes of Cobalamin Deficiency	101
■ Causes of Folate Deficiency	104
■ Diagnosis of Cobalamin and Folate Deficiencies	106
■ Megaloblastic Anemia Not Due to Cobalamin or Folate Deficiency or Altered Metabolism	108
■ Further Readings	108

The megaloblastic anemias are a group of disorders characterized by the presence of distinctive morphologic appearances of the developing red cells in the bone marrow. The cause is usually deficiency of either cobalamin (vitamin B<sub>12</sub>) or folate, but megaloblastic anemia may arise because of genetic or acquired abnormalities affecting the metabolism of these vitamins or because of defects in DNA synthesis not related to cobalamin or folate (Table 9-1). Cobalamin and folate absorption and metabolism are described next and then the biochemical basis, clinical and laboratory features, causes, and treatment of megaloblastic anemia. The marrow is usually cellular, and the anemia is based on ineffective erythropoiesis.

### COBALAMIN

Cobalamin (vitamin B<sub>12</sub>) exists in a number of different chemical forms. All have a cobalt atom at the center of a corrin ring. In nature, the vitamin is mainly in the 2-deoxyadenosyl (ado) form, which is located in mitochondria. It is the cofactor for the enzyme methylmalonyl CoA mutase. The other major natural cobalamin is methylcobalamin, the form in human plasma and in cell cytoplasm. It is the cofactor for methionine

synthase. There are also minor amounts of hydroxocobalamin to which methyl- and adocobalamin are rapidly converted by exposure to light.

### Dietary Sources and Requirements

Cobalamin is synthesized solely by microorganisms. Ruminants obtain cobalamin from the foregut, but the

TABLE 9-1

#### CAUSES OF MEGALOBLASTIC ANEMIA

Cobalamin deficiency or abnormalities of cobalamin metabolism (see Tables 9-3, 9-4)
Folate deficiency or abnormalities of folate metabolism (see Table 9-5)
Therapy with antifolate drugs (e.g., methotrexate)
Independent of either cobalamin or folate deficiency and refractory to cobalamin and folate therapy:
Some cases of acute myeloid leukemia, myelodysplasia
Therapy with drugs interfering with synthesis of DNA [e.g., cytosine arabinoside, hydroxyurea, 6-mercaptopurine, azidothymidine (AZT)]
Orotic aciduria (responds to uridine)
Thiamine-responsive



96 only source for humans is food of animal origin, e.g., meat, fish, and dairy products. Vegetables, fruits, and other foods of nonanimal origin are free from cobalamin unless they are contaminated by bacteria. A normal Western diet contains between 5 and 30  $\mu\text{g}$  of cobalamin daily. Adult daily losses (mainly in the urine and feces) are between 1 and 3  $\mu\text{g}$  ( $\sim 0.1\%$  of body stores) and, because the body does not have the ability to degrade cobalamin, daily requirements are also  $\sim 1\text{--}3 \mu\text{g}$ . Body stores are of the order of 2–3 mg, sufficient for 3–4 years if supplies are completely cut off.

### Absorption

Two mechanisms exist for cobalamin absorption. One is passive, occurring equally through buccal, duodenal, and ileal mucosa; it is rapid but extremely inefficient,  $<1\%$  of an oral dose is absorbed by this process. The normal physiologic mechanism is active; it occurs through the ileum and is efficient for small (a few micrograms) oral doses of cobalamin and is mediated by gastric intrinsic factor (IF). Dietary cobalamin is released from protein complexes by enzymes in the stomach, duodenum, and jejunum; it combines rapidly with a salivary glycoprotein that belongs to the family of cobalamin-binding proteins known as haptocorrins (HCs). In the intestine, the HC is digested by pancreatic trypsin and the cobalamin transferred to IF.

IF is produced in the gastric parietal cells of the fundus and body of the stomach, and its secretion parallels that of hydrochloric acid. The IF-cobalamin complex passes to the ileum, where IF attaches to a specific receptor (cubilin) on the microvillus membrane of the enterocytes. Cubilin is also present in yolk sac and renal proximal tubular epithelium. Cubilin appears to traffic by means of amnionless (AMN), an endocytic receptor protein that directs sublocalization and endocytosis of cubilin with its ligand IF-cobalamin complex. The cobalamin-IF complex enters the ileal cell where IF is destroyed. After a delay of  $\sim 6$  hours, the cobalamin appears in portal blood attached to transcobalamin (TC) II.

Between 0.5 and 5.0  $\mu\text{g}$  of cobalamin enters the bile each day. This binds to IF, and a major portion of biliary cobalamin is normally reabsorbed together with cobalamin derived from sloughed intestinal cells. Because of the appreciable amount of cobalamin undergoing enterohepatic circulation, cobalamin deficiency develops more rapidly in individuals who malabsorb cobalamin than it does in vegans, in whom reabsorption of biliary cobalamin is intact.

### Transport

Two main cobalamin transport proteins exist in human plasma; they both bind cobalamin—one molecule for one molecule. One HC, known as TC I, is closely

related to other cobalamin-binding HCs in milk, gastric juice, bile, saliva, and other fluids. These HCs differ from each other only in the carbohydrate moiety of the molecule. TC I is derived primarily from the specific granules in neutrophils. Normally, it is about two-thirds saturated with cobalamin, which it binds tightly. TC I does not enhance cobalamin entry into tissues. Glycoprotein receptors on liver cells are involved in the removal of TC I from plasma, and TC I may have a role in the transport of cobalamin analogues to the liver for excretion in bile.

The other major cobalamin transport protein in plasma is TC II. This is synthesized by liver and by other tissues, including macrophages, ileum, and endothelium. It normally carries only 20–60 ng of cobalamin per liter of plasma and readily gives up cobalamin to marrow, placenta, and other tissues, which it enters by receptor-mediated endocytosis.

## FOLATE

### Dietary Folate

Folic (pteroylglutamic) acid is a yellow, crystalline, water-soluble substance. It is the parent compound of a large family of natural folate compounds, which differ from it in three respects: (1) they are partly or completely reduced to di- or tetrahydrofolate (THF) derivatives; (2) they usually contain a single carbon unit (Table 9-2), and (3) 70–90% of natural folates are folate-polyglutamates.

Most foods contain some folate. The highest concentrations are found in liver, yeast, spinach, other greens, and nuts ( $>100 \mu\text{g}/100 \text{g}$ ). The total folate content of an average Western diet is  $\sim 250 \mu\text{g}$  daily, but the amount varies widely according to the type of food eaten and the method of cooking. Folate is easily destroyed by heating, particularly in large volumes of water. Total-body folate in the adult is  $\sim 10 \text{mg}$ , the liver containing the largest store. Daily adult requirements are  $\sim 100 \mu\text{g}$ , so stores are only sufficient for 3–4 months in normal adults and severe folate deficiency may develop rapidly.

### Absorption

Folates are absorbed rapidly from the upper small intestine. The absorption of folate polyglutamates is less efficient than for monoglutamates; on average,  $\sim 50\%$  of food folate is absorbed. Polyglutamate forms are hydrolyzed to the monoglutamate derivatives, either in the lumen of the intestine or within the mucosa. All dietary folates are converted to 5-methylTHF (5-MTHF) within the small-intestinal mucosa before entering portal plasma. The monoglutamates are actively transported across the enterocyte by a carrier-mediated mechanism. Pteroylglutamic acid at doses  $>400 \mu\text{g}$  is absorbed largely unchanged and converted to natural folates in the liver. Lower doses are

TABLE 9-2

## BIOCHEMICAL REACTIONS OF FOLATE COENZYMES

REACTION	COENZYME FORM OF FOLATE INVOLVED	SINGLE CARBON UNIT TRANSFERRED	IMPORTANCE
<i>Formate activation</i> <i>Purine synthesis</i> Formation of glycinamide ribonucleotide	THF	—CHO	Generation of 10-formyl-THF
Formylation of aminoimidazolecarboxamide-ribonucleotide (AICAR)	10-Formyl (CHO)THF		
<i>Pyrimidine synthesis</i> Methylation of deoxyuridine monophosphate (dUMP) to thymidine monophosphate (dTMP)	5,10-MethyleneTHF	—CH <sub>3</sub>	Rate limiting in DNA synthesis Oxidizes THF to DHF Some breakdown of folate at the C-9-N-10 bond
<i>Amino acid interconversion</i> Serine–glycine interconversion	THF	=CH <sub>2</sub>	Entry of single carbon units into active pool
Homocysteine to methionine	5-Methyl(M)THF	=CH <sub>3</sub>	Demethylation of 5-MTHF to THF; also requires cobalamin, flavine adenine dinucleotide, ATP, and adenosylmethionine
Forminoglutamic acid to glutamic acid in histidine catabolism	THF	—HN—CH=	

**Note:** DHF, dihydrofolate; THF, tetrahydrofolate.

converted to 5-MTHF during absorption through the intestine.

About 60–90 μg of folate enters the bile each day and is excreted into the small intestine. Loss of this folate, together with the folate of sloughed intestinal cells, accelerates the speed with which folate deficiency develops in malabsorption conditions.

### Transport

Folate is transported in plasma; about one-third is loosely bound to albumin and two-thirds unbound. In all body fluids (plasma, cerebrospinal fluid, milk, bile) folate is largely, if not entirely, 5-MTHF in the monoglutamate form. Two types of folate-binding protein are involved in entry of MTHF into cells. A high-affinity folate receptor takes folate into cells by endocytosis, is internalized by clathrin-coated pits or in a vesicle (caveola), which is then acidified, releasing folate. Folate is then carried by the membrane folate transporter into the cytoplasm. The high-affinity receptor is attached to the outer surface of the cell membrane by glycosyl phosphatidylinositol linkages. It may be involved in transport of oxidized folates and folate breakdown products to the liver for excretion in bile. An independent low-affinity reduced-folate carrier also mediates

uptake of physiologic folates into cells but also of methotrexate.

### Biochemical Functions

Folates (as the intracellular polyglutamate derivatives) act as coenzymes in the transfer of single-carbon units (Fig. 9-1 and Table 9-2). Two of these reactions are involved in purine and one in pyrimidine synthesis necessary for DNA and RNA replication. Folate is also a coenzyme for methionine synthesis, in which methylcobalamin is also involved and in which THF is regenerated. THF is the acceptor of single carbon units newly entering the active pool via conversion of serine to glycine. Methionine, the other product of the methionine synthase reaction, is the precursor for S-adenosylmethionine (SAM), the universal methyl donor involved in >100 methyltransferase reactions (Fig. 9-1).

During thymidylate synthesis, 5,10-methylene-THF is oxidized to DHF (dihydrofolate). The enzyme DHF reductase converts this to THF. The drugs methotrexate, pyrimethamine, and (mainly in bacteria) trimethoprim inhibit DHF reductase and so prevent formation of active THF coenzymes from DHF. A small fraction of the folate coenzyme is not recycled during thymidylate synthesis but is degraded.



## Cobalamin-Folate Relations

Folate is required for many reactions in mammalian tissues. Only two reactions in the body are known to require cobalamin. Methylmalonyl CoA isomerization, which requires adocobalamin, and the methylation of homocysteine to methionine requires both methylcobalamin and both 5-MTHF (Fig. 9-1). This reaction is the first step in the pathway by which 5-MTHF, which enters bone marrow and other cells from plasma, is converted into all the intracellular folate coenzymes. The coenzymes are all polyglutamated (the larger size aiding retention in the cell), but the enzyme folate polyglutamate synthase can use only THF, not MTHF, as substrate. In cobalamin deficiency, MTHF accumulates in plasma while intracellular folate concentrations fall due to failure of formation of THF, the substrate on which folate polyglutamates are built. This has been termed *THF starvation*, or the *methylfolate trap*.

This theory explains the abnormalities of folate metabolism that occur in cobalamin deficiency [high serum folate, low cell folate, positive purine precursor aminoimidazole carboxamide ribonucleotide (AICAR) excretion; Table 9-2] and also why the anemia of cobalamin deficiency responds to folic acid in large doses.

## CLINICAL FEATURES

Many symptomless patients are detected through the finding of a raised mean corpuscular volume (MCV) on a routine blood count. The main clinical features in more severe cases are those of anemia. Anorexia is usually marked and there may be weight loss, diarrhea, or constipation. Glossitis, angular cheilosis, a mild fever in the more severely anemic patients, jaundice (unconjugated), and reversible melanin skin hyperpigmentation may also occur with deficiency of either folate or cobalamin. Thrombocytopenia sometimes leads to bruising, and this may be aggravated by vitamin C deficiency or alcohol in malnourished patients. The anemia and low leukocyte count may predispose to infections, particularly of the respiratory or urinary tracts. Cobalamin deficiency has also been associated with impaired bactericidal function of phagocytes.

## General Tissue Effects of Cobalamin and Folate Deficiencies

### Epithelial Surfaces

After the marrow, the next most affected tissues are the epithelial cell surfaces of the mouth, stomach, and small intestine and the respiratory, urinary, and female genital tracts. The cells show macrocytosis, with increased numbers of multinucleate and dying cells. The deficiencies may cause cervical smear abnormalities.

### Complications of Pregnancy

The gonads are also affected, and infertility is common in both men and women with either deficiency. Maternal folate deficiency has been implicated as a cause of prematurity, and both folate and cobalamin deficiency have been implicated in recurrent fetal loss and neural tube defects, discussed later.

### Neural Tube Defects

Folic acid supplements at the time of conception and in the first 12 weeks of pregnancy reduce by ~70% the incidence of neural tube defects (NTDs) (anencephaly, meningomyelocele, encephalocele, and spina bifida) in the fetus. Most of this protective effect can be achieved by taking folic acid, 0.4 mg daily, at the time of conception.

The incidence of cleft palate and harelip can also be reduced by prophylactic folic acid. There is no clear simple relationship between maternal folate status and these fetal abnormalities, although overall the lower the maternal folate, the greater the risk to the fetus. NTDs can also be caused by antifolate and antiepileptic drugs.

An underlying maternal folate metabolic abnormality has also been postulated. One abnormality has been identified: reduced activity of the enzyme 5,10-methylene-THF reductase (MTHFR) (Fig. 9-1) caused by a common 677C→T polymorphism in the *MTHFR* gene. In one study, the prevalence of this polymorphism was found to be higher in the parents of NTD fetuses and in the fetuses themselves: homozygosity for the TT mutation was found in 13% compared with 5% in control subjects. The polymorphism codes for a thermolabile form of MTHFR. The homozygous state results in a lower mean serum and red cell folate level compared with control subjects, as well as significantly higher serum homocysteine levels. Tests for mutations in other enzymes possibly associated with NTDs, e.g., methionine synthase or serine-glycine hydroxymethylase, have been negative.

Autoantibodies to folate receptors have, however, been detected in 9 of 12 women who were or had been pregnant with a fetus with a NTD, but in only 2 of 20 control women. Antiserum to folate receptors results in resorption or multiple developmental abnormalities in mouse embryos. It is possible, therefore, that the association of antibodies to maternal folate receptors and NTDs reflects a causal relation.

### Cardiovascular Disease

Children with severe homocystinuria (blood levels  $\geq 100$   $\mu\text{mol/L}$ ) due to deficiency of one of three enzymes, methionine synthase, MHTFR, or cystathionine synthase (Fig. 9-1), suffer from vascular disease, e.g., ischemic heart disease, cerebrovascular disease, or pulmonary embolus as teenagers or in young adulthood. Lesser degrees of raised serum homocysteine and low levels of serum folate have been found to be associated

with cerebrovascular, peripheral vascular, and coronary heart disease and with deep vein thrombosis. Prospective randomized trials of lowering homocysteine levels with supplements of folic acid, vitamin B<sub>12</sub>, and vitamin B<sub>6</sub> against placebo over a 5-year period in patients with vascular disease or diabetes have not, however, shown a reduction of major cardiovascular events, nor have these supplements reduced the risk of recurrent cardiovascular disease after an acute myocardial infarct. It is possible that these trials were not sufficiently powered to detect a small (e.g., 10%) benefit or that some other underlying factor is responsible for both the vascular damage and the raised homocysteine. Alternatively, the beneficial effects of lowering homocysteine were offset in these trials by the vitamins stimulating endothelial cell proliferation. The results of longer and larger trials are needed to resolve these uncertainties.

### Malignancy

Prophylactic folic acid in pregnancy has been found to reduce the subsequent incidence of acute lymphoblastic leukemia (ALL) in childhood. A significant negative association has also been found with the *MTHFR* 677(C→T) polymorphism and leukemias with mixed lineage leukemia (MLL) translocations, but a positive association with hyperdiploidy in infants with ALL or acute myeloid leukemia or with childhood ALL. A second polymorphism in the *MHTFR* gene, A1298C, is also strongly associated with hyperdiploid leukemia. There are various positive and negative associations between polymorphisms in folate-dependent enzymes and the incidence of adult ALL. The C677T polymorphism is thought to lead to increased thymidine pools and “better quality” of DNA synthesis by shunting 1-carbon groups towards thymidine and purine synthesis. This may explain its reported association with a lower risk for colorectal cancer. Other tumors that have been associated with folate polymorphisms or status include follicular lymphoma, breast cancer, and gastric cancer.

### Neurologic Manifestations

Cobalamin deficiency may cause a bilateral peripheral neuropathy or degeneration (demyelination) of the posterior and pyramidal tracts of the spinal cord and, less frequently, optic atrophy or cerebral symptoms.

The patient, more frequently male, presents with paresthesias, muscle weakness, or difficulty in walking and sometimes dementia, psychotic disturbances, or visual impairment. Long-term nutritional cobalamin deficiency in infancy leads to poor brain development and impaired intellectual development. Folate deficiency has been suggested to cause organic nervous disease but this is uncertain, although methotrexate injected into the cerebrospinal fluid may cause brain or spinal cord damage.

An important clinical problem is the nonanemic patient with neurologic or psychiatric abnormalities and

a low or borderline serum cobalamin level. In such patients, it is necessary to try to establish whether or not there is significant cobalamin deficiency, e.g., by careful examination of the blood film, cobalamin absorption studies, tests for antibodies to IF or parietal cells, and serum methylmalonic acid (MMA) measurement if available. A trial of cobalamin therapy for at least 3 months will also usually be needed to determine whether the symptoms improve.

The biochemical basis for cobalamin neuropathy remains obscure. Its occurrence in the absence of methylmalonic aciduria in TC II deficiency suggests that the neuropathy is related to the defect in homocysteine-methionine conversion. Accumulation of *S*-adenosylhomocysteine in the brain, resulting in inhibition of transmethylation reactions, has been suggested.

Psychiatric disturbance is common in both folate and cobalamin deficiencies. This, like the neuropathy, has been attributed to a failure of the synthesis of SAM, which is needed in methylation of biogenic amines (e.g., dopamine) as well as of proteins, phospholipids, and neurotransmitters in the brain (Fig. 9-1). Associations between lower serum folate or cobalamin levels and higher homocysteine levels and the development of Alzheimer's disease have been reported. A 2-year double-blind placebo-controlled randomized clinical trial involving healthy subjects >65 years old given folate, cobalamin, and vitamin B<sub>6</sub> supplements showed no benefit on cognitive performance, whereas a 3-year (FACIT) study did show benefit.

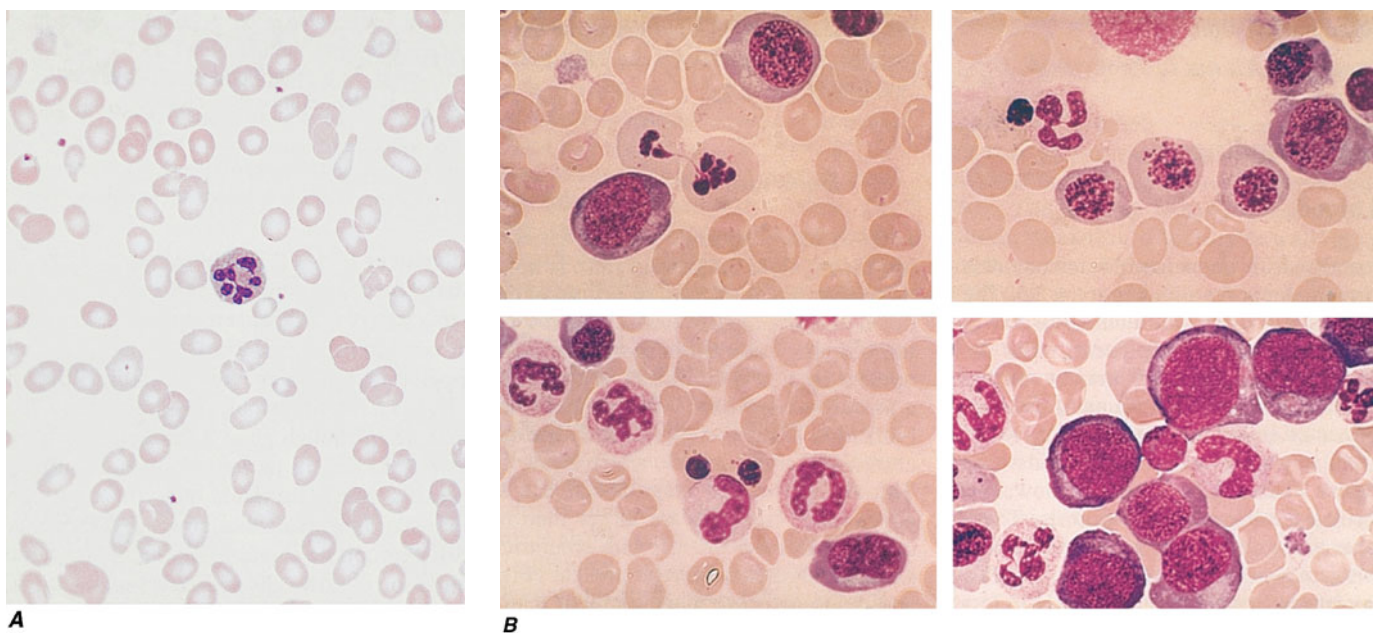
## HEMATOLOGIC FINDINGS

### Peripheral Blood

Oval macrocytes, usually with considerable anisocytosis and poikilocytosis, are the main feature (Fig. 9-2A). The MCV is usually >100 fL unless a cause of microcytosis (e.g., iron deficiency or thalassemia trait) is present. Some of the neutrophils are hypersegmented (more than five nuclear lobes). There may be leukopenia due to a reduction in granulocytes and lymphocytes, but this is usually >1.5 × 10<sup>9</sup>/L; the platelet count may be moderately reduced, rarely to <40 × 10<sup>9</sup>/L. The severity of all these changes parallels the degree of anemia. In the nonanemic patient, the presence of a few macrocytes and hypersegmented neutrophils in the peripheral blood may be the only indication of the underlying disorder.

### Bone Marrow

In the severely anemic patient, the marrow is hypercellular with an accumulation of primitive cells due to selective death by apoptosis of more mature forms. The erythroblast nucleus maintains a primitive appearance despite maturation and hemoglobinization of the

**FIGURE 9-2**

**A.** The peripheral blood in severe megaloblastic anemia.  
**B.** The bone marrow in severe megaloblastic anemia.  
 [Reprinted from Hoffbrand AV et al (eds) *Postgraduate*

*Haematology, 5th ed, Blackwell Publishing, Oxford, UK 2005; with permission.]*

cytoplasm. The cells are larger than normoblasts, and an increased number of cells with eccentric lobulated nuclei or nuclear fragments may be present (Fig. 9-2B). Giant and abnormally shaped metamyelocytes and enlarged hyperpolyploid megakaryocytes are characteristic. In less anemic patients, the changes in the marrow may be difficult to recognize. The terms *intermediate*, *mild*, and *early* have been used. The term *megaloblastoid* does not mean mildly megaloblastic. It is used to describe cells with both immature-appearing nuclei and defective hemoglobinization and is usually seen in myelodysplasia.

### Chromosomes

Bone marrow cells, transformed lymphocytes, and other proliferating cells in the body show a variety of changes including random breaks, reduced contraction, spreading of the centromere, and exaggeration of secondary chromosomal constrictions and overprominent satellites. Similar abnormalities may be produced by antimetabolite drugs (e.g., cytosine arabinoside, hydroxyurea, and methotrexate) that either interfere with DNA replication or folate metabolism and that also cause megaloblastic appearances.

### Ineffective Hemopoiesis

There is an accumulation of unconjugated bilirubin in plasma due to the death of nucleated red cells in the

marrow (ineffective erythropoiesis). Other evidence for this includes raised urine urobilinogen, reduced haptoglobins and positive urine hemosiderin, and a raised serum lactate dehydrogenase. A weakly positive direct antiglobulin test due to complement can lead to a false diagnosis of autoimmune hemolytic anemia.

### CAUSES OF COBALAMIN DEFICIENCY

Cobalamin deficiency is usually due to malabsorption. The only other cause is inadequate dietary intake.

### Inadequate Dietary Intake

#### Adults

Dietary cobalamin deficiency arises in vegans who omit meat, fish, eggs, cheese, and other animal products from their diet. The largest group in the world consists of Hindus, and it is likely that many millions of Indians are at risk of deficiency of cobalamin on a nutritional basis. Subnormal serum cobalamin levels are found in up to 50% of randomly selected, young, adult Indian vegans, but the deficiency usually does not progress to megaloblastic anemia because the diet of most vegans is not totally lacking cobalamin and the enterohepatic circulation of cobalamin is intact. Dietary cobalamin deficiency may also arise rarely in nonvegetarian individuals who exist on grossly inadequate diets because of poverty or psychiatric disturbance.

Cobalamin deficiency has been described in infants born to severely cobalamin-deficient mothers. These infants develop megaloblastic anemia at ~3–6 months of age, presumably because they are born with low stores of cobalamin and because they are fed breast milk of low cobalamin content. The babies have also shown growth retardation, impaired psychomotor development, and other neurologic sequelae.

### Gastric Causes of Cobalamin Malabsorption

See [Tables 9-3](#) and [9-4](#).

### Pernicious Anemia

Pernicious anemia (PA) may be defined as a severe lack of IF due to gastric atrophy. It is a common disease in north Europeans but occurs in all countries and ethnic groups. The overall incidence is ~120 per 100 000 population in the United Kingdom (UK). The ratio of incidence in men and women in whites is ~1:1.6 and the peak age of onset is 60 years, with only 10% of patients <40 years of age. However, in some ethnic groups, notably black individuals and Latin Americans, the age of onset of PA is generally lower. The disease occurs more commonly than by chance in close relatives and in persons with other organ-specific autoimmune diseases, e.g., thyroid diseases, vitiligo, hypoparathyroidism, and Addison's disease. It is also associated with hypogammaglobulinemia, with premature graying or blue eyes, and in persons of blood group A. An association with human leukocyte antigen (HLA) 3 has been reported in some but not all series and, in those with endocrine disease, with HLA-B8, -B12, and -BW15. The life expectancy is normal in women once regular treatment has begun. Men have a slightly subnormal life

**TABLE 9-3**

#### CAUSES OF COBALAMIN DEFICIENCY SUFFICIENTLY SEVERE TO CAUSE MEGALOBlastic ANEMIA

Nutritional	Vegans
Malabsorption	Pernicious anemia
Gastric causes	Congenital absence of intrinsic factor or functional abnormality
	Total or partial gastrectomy
Intestinal causes	Intestinal stagnant loop syndrome: jejunal diverticulosis, ileocolic fistula, anatomic blind loop, intestinal stricture, etc.
	Ileal resection and Crohn's disease
	Selective malabsorption with proteinuria
	Tropical sprue
	Transcobalamin II deficiency
	Fish tapeworm

**TABLE 9-4**

#### MALABSORPTION OF COBALAMIN MAY OCCUR IN THE FOLLOWING CONDITIONS BUT IS NOT USUALLY SUFFICIENTLY SEVERE AND PROLONGED TO CAUSE MEGALOBlastic ANEMIA

Gastric causes
Simple atrophic gastritis (food cobalamin malabsorption)
Zollinger-Ellison syndrome
Gastric bypass surgery
Use of proton pump inhibitors
Intestinal causes
Gluten-induced enteropathy
Severe pancreatitis
HIV infection
Radiotherapy
Graft-versus-host disease
Deficiencies of cobalamin, folate, protein, ?riboflavin, ?nicotinic acid
Therapy with colchicine, para-aminosalicylate, neomycin, slow-release potassium chloride, anticonvulsant drugs, metformin, phenformin, cytotoxic drugs
Alcohol

expectancy as a result of a higher incidence of carcinoma of the stomach than in control subjects. Gastric output of hydrochloric acid, pepsin, and IF are severely reduced. The serum gastrin level is raised, and serum pepsinogen I levels are low.

### Gastric Biopsy

This usually shows atrophy of all layers of the body and fundus, with loss of glandular elements, an absence of parietal and chief cells and replacement by mucous cells, a mixed inflammatory cell infiltrate, and perhaps intestinal metaplasia. The infiltrate of plasma cells and lymphocytes contains an excess of CD4 cells. The antral mucosa is usually well preserved. *Helicobacter pylori* infection is infrequent in PA, but it has been suggested that *H. pylori* gastritis occurs at an early phase of atrophic gastritis and presents in younger patients as iron-deficiency anemia but in older patients as PA. *H. pylori* is suggested to stimulate an autoimmune process directed against parietal cells, the *H. pylori* infection then being gradually replaced, in some individuals, by an autoimmune process.

### Serum Antibodies

Two types of IF immunoglobulin G antibody may be found in the sera of patients with PA. One, the "blocking," or type I, antibody, prevents the combination of IF and cobalamin, whereas the "binding," or type II, antibody prevents attachment of IF to ileal mucosa. Type I occurs in the sera of ~55% of patients and type II in 35%. IF antibodies cross the placenta and may cause temporary IF deficiency in the newborn infant. Patients with PA

also show cell-mediated immunity to IF. Type I antibody has been detected rarely in the sera of patients without PA but with thyrotoxicosis, myxedema, Hashimoto's disease, or diabetes mellitus and in relatives of PA patients. IF antibodies have also been detected in gastric juice in ~80% of PA patients. These gastric antibodies may reduce absorption of dietary cobalamin by combining with small amounts of remaining IF.

Parietal cell antibody is present in the sera of almost 90% of adult patients with PA but is frequently present in other subjects. Thus it occurs in as many as 16% of randomly selected female subjects >60 years of age. The parietal cell antibody is directed against the  $\alpha$  and  $\beta$  subunits of the gastric proton pump ( $H^+$ ,  $K^+$ -ATPase).

### Juvenile Pernicious Anemia

This usually occurs in older children and resembles PA of adults. Gastric atrophy, achlorhydria, and serum IF antibodies are all present, although parietal cell antibodies are usually absent. About half of these patients show an associated endocrinopathy such as autoimmune thyroiditis, Addison's disease, or hypoparathyroidism; in some, mucocutaneous candidiasis occurs.

### Congenital Intrinsic Factor Deficiency or Functional Abnormality

The affected child usually presents with megaloblastic anemia in the first to third year of life; a few have presented as late as the second decade. The child has no demonstrable IF but has a normal gastric mucosa and normal secretion of acid. The inheritance is autosomally recessive. Parietal cell and IF antibodies are absent. Variants have been described in which the child is born with IF that can be detected immunologically but is unstable or functionally inactive.

### Gastrectomy

Following total gastrectomy, cobalamin deficiency is inevitable, and prophylactic cobalamin therapy should be commenced immediately following the operation. After partial gastrectomy, 10–15% of patients also develop this deficiency. The exact incidence and time of onset are most influenced by the size of the resection and the preexisting size of cobalamin body stores.

### Food Cobalamin Malabsorption

Failure of release of cobalamin from binding proteins in food is believed to be responsible for this condition, more common in the elderly. It is associated with low serum cobalamin levels, with or without raised serum levels of MMA and homocysteine. Typically, these patients have normal cobalamin absorption, as measured with crystalline cobalamin, but show malabsorption when a modified test using food-bound cobalamin is

used. The frequency of progression to severe cobalamin deficiency and reasons for this progression are not clear.

### Intestinal Causes of Cobalamin Malabsorption

#### Intestinal Stagnant Loop Syndrome

Malabsorption of cobalamin occurs in a variety of intestinal lesions in which there is colonization of the upper small intestine by fecal organisms. This may occur in patients with jejunal diverticulosis, enteroanastomosis, or intestinal stricture or fistula or with an anatomic blood loop due to Crohn's disease, tuberculosis, or an operative procedure.

#### Ileal Resection

Removal of  $\geq 1.2$  m of terminal ileum causes malabsorption of cobalamin. In some patients following ileal resection, particularly if the ileocecal valve is incompetent, colonic bacteria may contribute further to the onset of cobalamin deficiency.

#### Selective Malabsorption of Cobalamin with Proteinuria (Imerlund Syndrome; Imerlund-Gräsbeck Syndrome; Congenital Cobalamin Malabsorption; Autosomal Recessive Megaloblastic Anemia, MGA1)

This autosomally recessive disease is the most common cause of megaloblastic anemia due to cobalamin deficiency in infancy in Western countries. More than 200 cases have been reported, with familial clusters in Finland, Norway, the Middle East, and North Africa. The patients secrete normal amounts of IF and gastric acid but are unable to absorb cobalamin. In Finland, impaired synthesis, processing, or ligand binding of cubilin due to inherited mutations is found. In Norway, mutation of the gene for *AMN* has been reported. Other tests of intestinal absorption are normal. Over 90% of the patients show nonspecific proteinuria, but renal function is otherwise normal and renal biopsy has not shown any consistent renal defect. A few have shown aminoaciduria and congenital renal abnormalities, such as duplication of the renal pelvis.

#### Tropical Sprue

Nearly all patients with acute and subacute tropical sprue show malabsorption of cobalamin; this may persist as the principal abnormality in the chronic form of the disease, when the patient may present with megaloblastic anemia or neuropathy due to cobalamin deficiency. Absorption of cobalamin usually improves after antibiotic therapy and, in the early stages, folic acid therapy.

#### Fish Tapeworm Infestation

The fish tapeworm (*Diphyllobothrium latum*) lives in the small intestine of humans and accumulates cobalamin from food, rendering this unavailable for absorption. Individuals acquire the worm by eating raw or partly



104 cooked fish. Infestation is common around the lakes of Scandinavia, Germany, Japan, North America, and Russia. Megaloblastic anemia or cobalamin neuropathy occurs only in those with a heavy infestation.

#### Gluten-Induced Enteropathy

Malabsorption of cobalamin occurs in ~30% of untreated patients (presumably those in whom the disease extends to the ileum). Cobalamin deficiency is not severe in these patients and is corrected with a gluten-free diet.

#### Severe Chronic Pancreatitis

In this condition, lack of trypsin is thought to cause dietary cobalamin attached to gastric non-IF (R) binder to be unavailable for absorption. It has also been proposed that in pancreatitis, the concentration of calcium ions in the ileum falls below the level needed to maintain normal cobalamin absorption.

#### HIV Infection

Serum cobalamin levels tend to fall in patients with HIV infection and are subnormal in 10–35% of those with AIDS. Malabsorption of cobalamin not corrected by IF has been shown in some, but not all, patients with subnormal serum cobalamin levels. Cobalamin deficiency sufficiently severe to cause megaloblastic anemia or neuropathy is rare.

#### Zollinger-Ellison syndrome

Malabsorption of cobalamin has been reported in the Zollinger-Ellison syndrome. It is thought that there is a failure to release cobalamin from R-binding protein due to inactivation of pancreatic trypsin by high acidity, as well as interference with IF binding of cobalamin.

#### Radiotherapy

Both total-body irradiation and local radiotherapy to the ileum (e.g., as a complication of radiotherapy for carcinoma of the cervix) may cause malabsorption of cobalamin.

#### Graft-versus-Host Disease

This commonly affects the small intestine. Malabsorption of cobalamin due to abnormal gut flora, as well as damage to ileal mucosa, is frequent.

#### Drugs

Table 9-4 lists the drugs that have been reported to cause malabsorption of cobalamin. Megaloblastic anemia due to these drugs, however, is rare.

### Abnormalities of Cobalamin Metabolism

#### Congenital Transcobalamin II Deficiency or Abnormality

Infants with TC II deficiency usually present with megaloblastic anemia within a few weeks of birth.

Serum cobalamin and folate levels are normal, but the anemia responds to massive (e.g., 1 mg three times weekly) injections of cobalamin. Some cases show neurologic complications. The protein may be present but functionally inert. Genetic abnormalities found include mutations of an intra-exonic cryptic splice site, extensive deletion, single nucleotide deletion, nonsense mutation, and an RNA editing defect. Malabsorption of cobalamin occurs in all cases and serum immunoglobulins are usually reduced. Failure to institute adequate cobalamin therapy or treatment with folic acid may lead to neurologic damage.

#### Congenital Methylmalonic Acidemia and Aciduria

The infants with this abnormality are ill from birth with vomiting, failure to thrive, severe metabolic acidosis, ketosis, and mental retardation. Anemia, if present, is normocytic and normoblastic. The condition may be due to a functional defect in either mitochondrial methylmalonyl CoA mutase or its cofactor adocobalamin. Mutations in the methylmalonyl CoA mutase are not responsive, or only poorly responsive, to treatment with cobalamin. A proportion of the infants with failure of adocobalamin synthesis respond to cobalamin in large doses. Some children have combined methylmalonic aciduria and homocystinuria due to defective formation of both cobalamin coenzymes. This usually presents in the first year of life with feeding difficulties, developmental delay, microcephaly, seizures, hypotonia, and megaloblastic anemia.

#### Acquired Abnormality of Cobalamin Metabolism: Nitrous Oxide Inhalation

Nitrous oxide irreversibly oxidizes methylcobalamin to an inactive precursor; this inactivates methionine synthase. Megaloblastic anemia has occurred in patients undergoing prolonged N<sub>2</sub>O anesthesia (e.g., in intensive care units). A neuropathy resembling cobalamin neuropathy has also been described in dentists and anesthetists who are repeatedly exposed to N<sub>2</sub>O. Methylmalonic aciduria does not occur because adocobalamin is not inactivated by N<sub>2</sub>O.

## CAUSES OF FOLATE DEFICIENCY

(Table 9-5)

### Nutritional

Dietary folate deficiency is common. Indeed, in most patients with folate deficiency a nutritional element is present. Certain individuals are particularly prone to have diets containing inadequate amounts of folate (Table 9-5). In the United States and other countries where fortification of the diet with folic acid has been

TABLE 9-5

## CAUSES OF FOLATE DEFICIENCY

Dietary<sup>a</sup>

Particularly in old age, infancy, poverty, alcoholism, chronic invalids, and the psychiatrically disturbed; may be associated with scurvy or kwashiorkor

## Malabsorption

## Major causes of deficiency

Tropical sprue, gluten-induced enteropathy in children and adults, and in association with dermatitis herpetiformis, specific malabsorption of folate, intestinal megaloblastosis caused by severe cobalamin or folate deficiency

## Minor causes of deficiency

Extensive jejunal resection, Crohn's disease, partial gastrectomy, congestive heart failure, Whipple's disease, scleroderma, amyloid, diabetic enteropathy, systemic bacterial infection, lymphoma, salazopyrine

## Excess utilization or loss

## Physiologic

Pregnancy and lactation, prematurity

## Pathologic

Hematologic diseases: chronic hemolytic anemias, sickle cell anemia, thalassemia major, myelofibrosis  
Malignant diseases: carcinoma, lymphoma, leukemia, myeloma

Inflammatory diseases: tuberculosis, Crohn's disease, psoriasis, exfoliative dermatitis, malaria

Metabolic disease: homocystinuria

Excess urinary loss: congestive heart failure, active liver disease

Hemodialysis, peritoneal dialysis

Antifolate drugs<sup>b</sup>

Anticonvulsant drugs (phenytoin, primidone, barbiturates), sulphasalazine

Nitrofurantoin, tetracycline, anti-tuberculosis (less well documented)

## Mixed causes

Liver diseases, alcoholism, intensive care units

<sup>a</sup>In severely folate-deficient patients with causes other than those listed under Dietary, poor dietary intake is often present.

<sup>b</sup>Drugs inhibiting dihydrofolate reductase are discussed in the text.

adopted, the prevalence of folate deficiency has dropped dramatically and is now almost restricted to high-risk groups with increased folate needs. Nutritional folate deficiency occurs in kwashiorkor and scurvy and in infants with repeated infections or who are fed solely on goat's milk, which has a low folate content.

**Malabsorption**

Malabsorption of dietary folate occurs in tropical sprue and in gluten-induced enteropathy. In the rare congenital syndrome of selective malabsorption of folate, there is an associated defect of folate transport into the cerebrospinal fluid, and these patients show megaloblastic

anemia, which responds to physiologic doses of folic acid given parenterally but not orally. They also show mental retardation, convulsions, and other central nervous system abnormalities. Minor degrees of malabsorption may also occur following jejunal resection or partial gastrectomy, in Crohn's disease, and in systemic infections but, in these conditions, if severe deficiency occurs, it is usually largely due to poor nutrition. Malabsorption of folate has been described in patients receiving salazopyrin, cholestyramine, and triamterene.

**Excess Utilization or Loss****Pregnancy**

Folate requirements are increased by 200–300  $\mu\text{g}$  to ~400  $\mu\text{g}$  daily in a normal pregnancy, partly because of transfer of the vitamin to the fetus, but mainly because of increased folate catabolism due to cleavage of folate coenzymes in rapidly proliferating tissues. Megaloblastic anemia due to this deficiency is prevented by prophylactic folic acid therapy. It occurred in 0.5% of pregnancies in the UK and other Western countries before prophylaxis with folic acid, but the incidence is much higher in countries where the general nutritional status is poor.

**Prematurity**

The newborn infant, whether full term or premature, has higher serum and red cell folate concentrations than the adult. However, the newborn infant's demand for folate has been estimated to be up to 10 times that of adults on a weight basis, and the neonatal folate level falls rapidly to the lowest values at ~6 weeks of age. The falls are steepest and are liable to reach subnormal levels in premature babies, a number of whom develop megaloblastic anemia responsive to folic acid at ~4–6 weeks of age. This occurs particularly in the smallest babies (<1500 g birth weight) and in those who have feeding difficulties or infections or who have undergone multiple exchange transfusions. In these babies, prophylactic folic acid should be given.

**Hematologic Disorders**

Folate deficiency frequently occurs in chronic hemolytic anemia, particularly in sickle cell disease, autoimmune hemolytic anemia, and congenital spherocytosis. In these and other conditions of increased cell turnover (e.g., myelofibrosis, malignancies) folate deficiency arises because it is not completely reused after performing coenzyme functions.

**Inflammatory Conditions**

Chronic inflammatory diseases, such as tuberculosis, rheumatoid arthritis, Crohn's disease, psoriasis, exfoliative dermatitis, bacterial endocarditis, and chronic bacterial infections, cause deficiency by reducing the

106 appetite and by increasing the demand for folate. Systemic infections may also cause malabsorption of folate. Severe deficiency is virtually confined to the patients with the most active disease and the poorest diet.

### Homocystinuria

This is a rare metabolic defect in the conversion of homocysteine to cystathionine. Folate deficiency occurring in most of these patients may be due to excessive utilization because of compensatory increased conversion of homocysteine to methionine.

### Long-term Dialysis

Because folate is only loosely bound to plasma proteins, it is easily removed from plasma by dialysis. In patients with anorexia, vomiting, infections, and hemolysis, folate stores are particularly likely to become depleted. Routine folate prophylaxis is now given.

### Congestive Heart Failure, Liver Disease

Excess urinary folate losses of  $>100 \mu\text{g}/\text{d}$  may occur in some of these patients. The explanation appears to be release of folate from damaged liver cells.

### Antifolate Drugs

A large number of epileptics, who are receiving long-term therapy with phenytoin or primidone, with or without barbiturates, develop low serum and red cell folate levels. The exact mechanism is unclear. Alcohol may also be a folate antagonist, as patients who are drinking spirits may develop megaloblastic anemia that will respond to normal quantities of dietary folate or to physiologic doses of folic acid only if alcohol is withdrawn. Macrocytosis of red cells is associated with chronic alcohol intake even when folate levels are normal. Inadequate folate intake is the major factor in the development of deficiency in spirit-drinking alcoholics. Beer is relatively folate-rich in some countries, depending on the technique used for brewing.

The drugs that inhibit DHF reductase include methotrexate, pyrimethamine, and trimethoprim. Methotrexate has the most powerful action against the human enzyme, whereas trimethoprim is most active against the bacterial enzyme and is only likely to cause megaloblastic anemia when used in conjunction with sulphamethoxazole in patients with preexisting folate or cobalamin deficiency. The activity of pyrimethamine is intermediate. The antidote to these drugs is folinic acid (5-formyl-THF).

### Congenital Abnormalities of Folate Metabolism

Some infants with congenital defects of folate enzymes (e.g., cyclohydrolase or methionine synthase) have had megaloblastic anemia.

## DIAGNOSIS OF COBALAMIN AND FOLATE DEFICIENCIES

The diagnosis of cobalamin or folate deficiency has traditionally depended on the recognition of the relevant abnormalities in the peripheral blood and analysis of the blood levels of the vitamins.

### Serum Cobalamin

This is measured by an automated enzyme-linked immunoadsorbent (ELISA) assay. Normal serum levels range from 118–148 pmol/L (160–200 ng/L) to ~738 pmol/L (1000 ng/L). In patients with megaloblastic anemia due to cobalamin deficiency, the level is usually  $<74 \text{ pmol/L}$  (100 ng/L). In general, the more severe the deficiency, the lower the serum cobalamin level. In patients with spinal cord damage due to the deficiency, levels are very low even in the absence of anemia. Values between 74 and 148 pmol/L (100 and 200 ng/L) are regarded as borderline. They may occur, for instance, in pregnancy, in patients with megaloblastic anemia due to folate deficiency. The serum cobalamin level is generally considered to be sufficiently robust, cost-effective, and most convenient to rule out cobalamin deficiency in the vast majority of patients suspected of having this problem.

### Serum Methylmalonate and Homocysteine

In patients with cobalamin deficiency sufficient to cause anemia or neuropathy, the serum MMA level is raised. Sensitive methods for measuring MMA and homocysteine in serum have been introduced and recommended for the early diagnosis of cobalamin deficiency, even in the absence of hematologic abnormalities or subnormal levels of serum cobalamin. Serum MMA levels fluctuate, however, in patients with renal failure. Mildly elevated serum MMA and/or homocysteine levels occur in up to 30% of apparently healthy volunteers, with serum cobalamin levels up to 258 pmol/L (350 ng/L) and normal serum folate levels; 15% of elderly subjects, even with cobalamin levels  $>258 \text{ pmol/L}$  ( $>350 \text{ ng/L}$ ), have this pattern of raised metabolite levels. These findings bring into question the exact cutoff points for normal MMA and homocysteine levels. It is also unclear at present whether these mildly raised metabolite levels have clinical consequences.

Serum homocysteine is raised in both early cobalamin and folate deficiency but may be raised in other conditions, e.g., chronic renal disease, alcoholism, smoking, pyridoxine deficiency, hypothyroidism, therapy with steroids, cyclosporine, and other drugs. Levels are also higher in serum than in plasma, in men than in premenopausal women, in women taking hormone replacement therapy, or in oral contraceptive users and

in elderly persons and patients with several inborn errors of metabolism affecting enzymes in trans-sulfuration pathways of homocysteine metabolism. Thus homocysteine levels are not used for diagnosis of cobalamin or folate deficiency.

### Cobalamin Absorption

Studies of cobalamin absorption have been widely used, but difficulty in obtaining radioactive cobalamin and of ensuring IF preparations are free of viruses have led to reduced availability. For the urinary excretion (Schilling) test, the patient is fasted overnight. Radioactive cyanocobalamin is given orally. Then, 2 hours later an IM injection of cyanocobalamin or hydroxocobalamin (1 mg) is given (“flushing dose”). A 24-hour urine specimen is collected for determination of radioactivity; low excretion shows malabsorption; the oral dose is then given again after 48 hours with IF. The results distinguish between gastric and intestinal causes of cobalamin malabsorption.

### Serum Folate

This is also measured by an ELISA technique. In most laboratories, the normal range is from 11 nmol/L (2.0 µg/L) to ~82 nmol/L (15 µg/L). The serum folate level is low in all folate-deficient patients. It also reflects recent diet. Because of this, serum folate may be low before there is hematologic or biochemical evidence of deficiency. Serum folate rises in severe cobalamin deficiency because of the block in conversion of MTHF to THF inside cells; raised levels have also been reported in the intestinal stagnant loop syndrome, due to absorption of bacterially synthesized folate.

### Red Cell Folate

The red cell folate assay is a valuable test of body folate stores. It is less affected than the serum assay by recent diet and traces of hemolysis. In normal adults, concentrations range from 880–3520 µmol/L (160–640 µg/L) of packed red cells. Subnormal levels occur in patients with megaloblastic anemia due to folate deficiency but also in nearly two-thirds of patients with severe cobalamin deficiency. False-normal results may occur if the folate-deficient patient has received a recent blood transfusion or if the patient has a raised reticulocyte count.

### **Rx** Treatment: MEGALOBlastic ANEMIA

It is usually possible to establish which of the two deficiencies, folate or cobalamin, is the cause of the anemia and to treat only with the appropriate vitamin. In

patients who enter hospital severely ill, however, it may be necessary to treat with both vitamins in large doses once blood samples have been taken for cobalamin and folate assays and a bone marrow biopsy has been performed (if deemed necessary). Transfusion is usually unnecessary and inadvisable. If it is essential, packed red cells should be given slowly, one or two units only, with the usual treatment for heart failure if present. Potassium supplements have been recommended to obviate the danger of the hypokalemia that has been recorded in some patients during the initial hematologic response. Occasionally, an excessive rise in platelets occurs after 1–2 weeks of therapy. Antiplatelet therapy, e.g., aspirin, should be considered if the platelet count rises to  $>800 \times 10^9/L$ .

### TREATMENT OF COBALAMIN DEFICIENCY

It is usually necessary to treat patients who have developed cobalamin deficiency with lifelong regular cobalamin injections. In the UK, the form used is hydroxocobalamin; in the United States, cyanocobalamin. In a few instances, the underlying cause of cobalamin deficiency can be permanently corrected, e.g., the fish tapeworm, tropical sprue, or an intestinal stagnant loop that is amenable to surgery. The indications for starting cobalamin therapy are a well-documented megaloblastic anemia or other hematologic abnormalities or neuropathy due to the deficiency. Patients with borderline serum cobalamin levels but no hematologic or other abnormality should be followed, e.g., at yearly intervals to make sure that the cobalamin deficiency does not progress. If malabsorption of cobalamin or rises in serum MMA levels have also been demonstrated, however, they should also be given regular maintenance cobalamin therapy. Cobalamin should be given routinely to all patients who have had a total gastrectomy or ileal resection. Patients who have undergone gastric reduction for control of obesity or who are receiving long-term treatment with proton pump inhibitors should be screened and, if necessary, given cobalamin replacement.

Replenishment of body stores should be complete with six 1000-µg IM injections of hydroxocobalamin given at 3- to 7-day intervals. More frequent doses are usually used in patients with cobalamin neuropathy, but no evidence indicates that these produce a better response. For maintenance therapy, 1000 µg hydroxocobalamin IM once every 3 months is satisfactory. Because of the poorer retention of cyanocobalamin, protocols generally use higher and more frequent doses, e.g., 1000 µg IM, monthly, for maintenance treatment.

Toxic reactions are extremely rare and are usually due to contamination in its preparation rather than to cobalamin itself. Because a small fraction of cobalamin can be absorbed passively through mucous membranes

even when there is complete failure of physiological IF-dependent absorption, large daily oral doses (1000–2000 µg) of cyanocobalamin can be used in PA for replacement and maintenance of normal cobalamin status. Sublingual therapy has also been proposed for those in whom injections are difficult because of a bleeding tendency and may not tolerate oral therapy. If oral therapy is used, it is important to monitor compliance, particularly with elderly, forgetful patients.

**TREATMENT OF FOLATE DEFICIENCY** Oral doses of 5–15 mg folic acid daily are satisfactory because sufficient folate is absorbed from these extremely large doses even in patients with severe malabsorption. The length of time therapy must be continued depends on the underlying disease. It is customary to continue therapy for ~4 months, when all folate-deficient red cells will have been eliminated and replaced by new folate-replete populations.

Before large doses of folic acid are given, cobalamin deficiency must be excluded and, if present, corrected, otherwise cobalamin neuropathy may develop, despite a response of the anemia of cobalamin deficiency to folate therapy. Studies in the United States, however, suggest that there is no increase in the proportion of individuals with low serum cobalamin levels and no anemia since food fortification with folic acid, but it is unknown if there has been a change in the incidence of cobalamin neuropathy.

Long-term folic acid therapy is required when the underlying cause of the deficiency cannot be corrected and the deficiency is likely to recur, for instance, in chronic dialysis or hemolytic anemias. It may also be necessary in gluten-induced enteropathy if this does not respond to a gluten-free diet. Where mild but chronic folate deficiency occurs, it is preferable to encourage improvement in the diet after correcting the deficiency with a short course of folic acid. In any patient receiving long-term folic acid therapy, it is important to measure the serum cobalamin level at regular (e.g., once yearly) intervals to exclude the coincidental development of cobalamin deficiency.

**Folinic Acid (5-Formyl-THF)** This is a stable form of fully reduced folate. It is given orally or parenterally to overcome the toxic effects of methotrexate or other DHF reductase inhibitors.

**PROPHYLACTIC FOLIC ACID** In many countries, food is fortified with folic acid (in grain or flour) to prevent neural tube defects. It is also used in chronic dialysis patients and in parenteral feeds. Prophylactic folic acid has been used to reduce homocysteine levels to prevent cardiovascular disease, but further data are needed to assess the benefit for this and for cognitive function in the elderly.

**Pregnancy** Folic acid, 400 µg daily, should be given as a supplement before and throughout pregnancy. In women who have had a previous fetus with a neural tube defect, 5 mg daily is recommended when pregnancy is contemplated and throughout the subsequent pregnancy.

**Infancy and Childhood** The incidence of folate deficiency is so high in the smallest premature babies during the first 6 weeks of life that folic acid (e.g., 1 mg daily) should be given routinely to those weighing <1500 g at birth and to larger premature babies who require exchange transfusions or develop feeding difficulties, infections, or vomiting and diarrhea.

The World Health Organization currently recommends routine supplementation with iron and folic acid in children in countries where iron deficiency is common and child mortality, largely due to infectious diseases, is high. However, some studies suggest that where malaria rates are high, this approach may increase the incidence of severe illness and death. Even where malaria is rare, there appears to be no survival benefit.

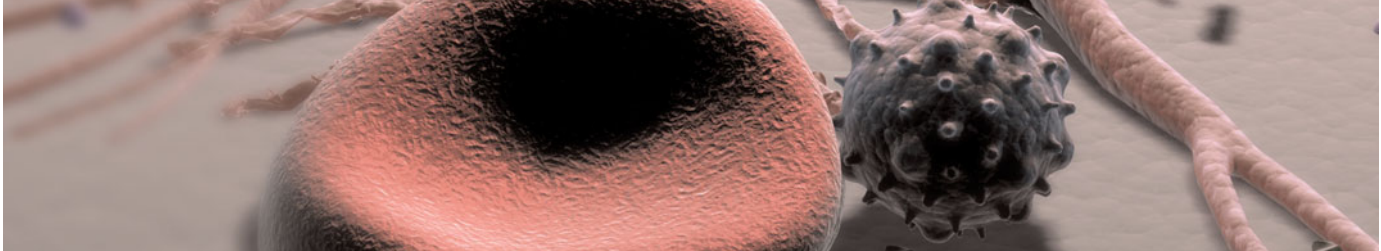
### MEGALOBlastic ANEMIA NOT DUE TO COBALAMIN OR FOLATE DEFICIENCY OR ALTERED METABOLISM

This may occur with many antimetabolic drugs (e.g., hydroxyurea, cytosine arabinoside, 6-mercaptopurine) that inhibit DNA replication. Antiviral nucleoside analogues used in treatment of HIV infection may also cause macrocytosis and megaloblastic marrow changes. In the rare disease orotic aciduria, two consecutive enzymes in purine synthesis are defective. The condition responds to therapy with uridine, which bypasses the block. In thiamine-responsive megaloblastic anemia, there is a genetic defect in the high-affinity thiamine transport (*SLC19A2*) gene. This causes defective RNA ribose synthesis through impaired activity of transketolase, a thiamine-dependent enzyme in the pentose cycle. This leads to reduced nucleic acid production. It may be associated with diabetes mellitus and deafness and the presence of many ringed sideroblasts in the marrow. The explanation is unclear for megaloblastic changes in the marrow in some patients with acute myeloid leukemia and myelodysplasia.

### FURTHER READINGS

- BAZZANO LA et al: Effect of folic acid supplementation on risk of cardiovascular diseases. *JAMA* 296:2720, 2006
- BERGMANN AK et al: Thiamine-responsive megaloblastic anemia: Identification of novel compound heterozygotes and mutation update. *J Pediatr* 2009; July 29 (Epub ahead of print)

- BONAA KH et al: Homocysteine lowering and cardiovascular events after acute myocardial infarction. *N Engl J Med* 354:1578, 2006
- CHAN JCW et al: Pernicious anemia in Chinese: A study of 181 patients in a Hong Kong Hospital. *Medicine* 85:129, 2006
- DALI-YOUCHEF N, Andres E: An update on cobalamin deficiency in adults. *QJM* 102:17, 2009
- DURGA J et al: Effect of 3-year folic acid supplementation on cognitive function in older adults in the FACIT trial: A randomized double-blind, controlled trial. *Lancet* 369:208, 2007
- HERSHKO C et al: Variable hematologic presentation of autoimmune gastritis: Age-related progression from iron deficiency to cobalamin depletion. *Blood* 107:1673, 2006
- KAFERLE J, Strzoda CE: Evaluation of macrocytosis. *Am Fam Physician* 79:203, 2009
- LONN E et al: Homocysteine lowering with folic acid and B vitamins in vascular disease. *N Engl J Med* 354:1567, 2006
- MCMAHON JA et al: A controlled trial of homocysteine lowering and cognitive performance. *N Engl J Med* 354:2764, 2006
- MILLS JL et al: Low vitamin B12 concentrations in patients without anemia: The effect of folic acid fortification of grain. *Am J Clin Nutr* 77:1474, 2003
- ROTHENBERG SP et al: Autoantibodies against folate receptors in women with a pregnancy complicated by a neural tube defect. *N Engl J Med* 350:134, 2004
- SAZAWAL S et al: Effects of routine prophylactic supplementation with iron and folic acid on admission to hospital and mortality in preschool child mortality in Southern Nepal: Community-based, cluster-randomized, placebo-controlled trial. *Lancet* 367:144, 2006
- WANG YH et al: An investigation of vitamin B<sub>12</sub> deficiency in elderly patients in a neurology department. *Neurosci Bull* 25:209, 2009



## CHAPTER 10

# HEMOLYTIC ANEMIAS AND ANEMIA DUE TO ACUTE BLOOD LOSS

Lucio Luzzatto

Definitions . . . . .	110
■ Hemolytic Anemias . . . . .	110
General Clinical and Laboratory Features . . . . .	110
General Pathophysiology . . . . .	111
Inherited Hemolytic Anemias . . . . .	113
Genetic Considerations . . . . .	117
Acquired Hemolytic Anemia . . . . .	121
■ Anemia Due to Acute Blood Loss . . . . .	126
■ Further Readings . . . . .	127

### DEFINITIONS

A finite life span is a distinct characteristic of red cells. Hence a logical, time-honored classification of anemias comprises three groups: decreased production of red cells, increased destruction of red cells, and acute blood loss. Red cell destruction and acute loss, both associated with increased reticulocyte production, are covered in this chapter. Red cell production defects are discussed in Chaps. 7–9.

Physical loss of red cells from the bloodstream—which in most cases also means physical loss *from* the body—is fundamentally different from destruction of red cells *within* the body. Therefore the clinical aspects and the pathophysiology of anemia in these two groups of patients are quite different, and they are considered separately.

### HEMOLYTIC ANEMIAS

Anemias due to increased destruction of red cells, or hemolytic anemias (HAs), may be *inherited* or *acquired*. From the clinical point of view, they may be more *acute* or more *chronic*, and they may vary from mild to very severe. The site of hemolysis may be predominantly *intravascular* or *extravascular*. With respect to mechanisms, HAs may be due to *intracorpuscular* or *extracorpuscular*

causes (Table 10-1); however, before reviewing the individual types of HAs, it is appropriate to consider what they have in common.

### GENERAL CLINICAL AND LABORATORY FEATURES

The clinical presentation of a patient with anemia is greatly influenced by whether the onset is abrupt or gradual, and HA is no exception. A patient with autoimmune hemolytic anemia or with favism may be a medical emergency, whereas a patient with mild hereditary spherocytosis or with cold agglutinin disease may be diagnosed after years. This is due in large measure to the remarkable ability of the body to adapt to anemia when it is slowly progressing (Chap. 2).

What differentiates HA from other anemias is that the patient has signs and symptoms arising directly from hemolysis (Table 10-2). At the clinical level, the main sign is *jaundice*; in addition, the patient may report discoloration of the urine. In many cases of HA, the spleen is enlarged because it is a preferential site of hemolysis; in some cases the liver may be enlarged as well. In all severe congenital forms of HA, skeletal changes may be noted due to overactivity of the bone marrow (although they are never as severe as in thalassemia).

TABLE 10-1

CLASSIFICATION OF HEMOLYTIC ANEMIAS<sup>a</sup>

	INTRACORPUSCULAR DEFECTS	EXTRACORPUSCULAR FACTORS
Hereditary	Hemoglobinopathies Enzymopathies Membrane-cytoskeletal defects	Familial hemolytic uremic syndrome (HUS)
Acquired	Paroxysmal nocturnal hemoglobinuria (PNH)	Mechanical destruction (microangiopathic) Toxic agents Drugs Infectious Autoimmune

<sup>a</sup>There is a strong correlation between hereditary causes and intracorporeal defects because such defects are due to inherited mutations; the one exception is PNH because the defect is due to an acquired somatic mutation. There is also a strong correlation between acquired causes and extracorporeal factors; the one exception is familial HUS because here an inherited abnormality allows excessive complement activation, with bouts of production of membrane attack complex capable of severely damaging normal cells.

The laboratory features of HA are related to (1) hemolysis per se and (2) the erythropoietic response of the bone marrow. In the serum, hemolysis regularly produces an increased unconjugated bilirubin, increased lactate dehydrogenase (LDH), increased aspartate transaminase, and reduced haptoglobin. Urobilinogen is increased in both urine and stool. If hemolysis is mainly intravascular, the telltale sign is hemoglobinuria, often associated with hemosiderinuria and an increase in serum hemoglobin; in contrast, the bilirubin level may be normal or only mildly elevated. The main sign of the erythropoietic response by the bone marrow is an increase in reticulocytes (a test all too often neglected in the initial workup of a patient with anemia). Usually the increase is reflected in both the percentage of reticulocytes (the more commonly quoted

figure) and the absolute reticulocyte count (the more definitive parameter). The increased number of reticulocytes is associated with an increased mean corpuscular volume (MCV) in the blood count. On the blood smear this is reflected in the presence of macrocytes; there is also polychromasia and sometimes nucleated red cells. In most cases a bone marrow aspirate is not necessary in the diagnostic workup; if it is done, it will show erythroid hyperplasia. In practice, once an HA is suspected, specific tests are usually required for a definitive diagnosis of the specific type of HA.

## GENERAL PATHOPHYSIOLOGY

The mature red cell is the product of a developmental pathway that brings the phenomenon of differentiation to an extreme. An orderly sequence of events produces synchronous changes whereby the gradual accumulation of a huge amount of hemoglobin in the cytoplasm (to a final level of 340 g/L, i.e., ~5 mM) goes hand in hand with the gradual loss of cellular organelles and of biosynthetic abilities. In the end the erythroid cell undergoes a process that has features of apoptosis, including nuclear pyknosis and actual loss of the nucleus. However, the final result is more altruistic than suicidal; the cytoplasmic body, instead of disintegrating, is now able to provide oxygen to all cells in the human organism for some remaining 120 days of the red cell “life” span.

As a result of this unique process of differentiation and maturation, intermediary metabolism is drastically curtailed in mature red cells (Fig. 10-1); for instance, cytochrome-mediated oxidative phosphorylation has been lost with the loss of mitochondria; therefore there is no backup to anaerobic glycolysis for the production

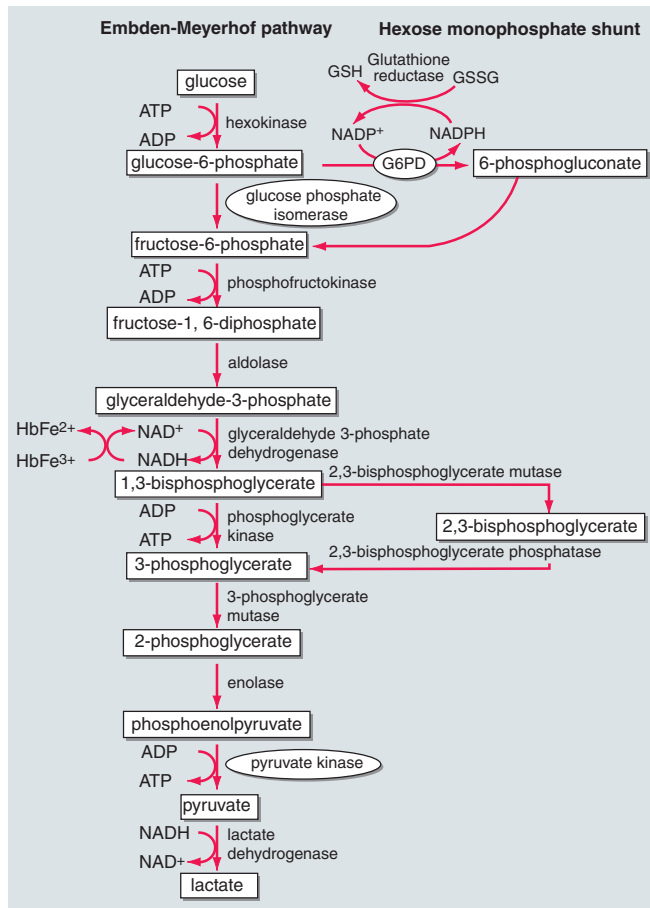
TABLE 10-2

## GENERAL FEATURES OF HEMOLYTIC DISORDERS

<i>General examination</i>	Jaundice, pallor
<i>Other physical findings</i>	Spleen may be enlarged; bossing of skull in severe congenital cases
<i>Hemoglobin</i>	From normal to severely reduced
<i>MCV, MCH</i>	Usually increased
<i>Reticulocytes</i>	Increased
<i>Bilirubin</i>	Increased (mostly unconjugated)
<i>LDH</i>	Increased (up to 10× normal with intravascular hemolysis)
<i>Haptoglobin</i>	Reduced to absent

**Note:** MCV, mean corpuscular volume; MCH, mean corpuscular hemoglobin; LDH, lactate dehydrogenase.





**FIGURE 10-1**

**RBC metabolism.** The Embden-Meyerhof pathway (glycolysis) generates ATP for energy and membrane maintenance. The generation of NADPH maintains hemoglobin in a reduced state. The hexose monophosphate shunt generates NADPH that is used to reduce glutathione, which protects the red cell against oxidant stress. Regulation of 2,3-bisphosphoglycerate levels is a critical determinant of oxygen affinity of hemoglobin. Enzyme deficiency states in order of prevalence: glucose-6-phosphate dehydrogenase (G6PD) >>>pyruvate kinase >glucose-6-phosphate isomerase >rare deficiencies of other enzymes in the pathway. The more common enzyme deficiencies are circled.

of adenosine triphosphate (ATP). Also, the capacity of making protein has been lost with the loss of ribosomes. This places the cell's limited metabolic apparatus at risk because if any protein component deteriorates, it cannot be replaced as in most other cells; and in fact the activity of most enzymes gradually decreases as red cells age. Another consequence of the relative simplicity of red cells is that they have a very limited range of ways to manifest distress under hardship: in essence, any sort of metabolic failure will eventually lead either to structural damage to the membrane or to failure of the cation pump. In either case the life span of the red cell is

reduced, which is the definition of a *hemolytic disorder*. If the rate of red cell destruction exceeds the capacity of the bone marrow to produce more red cells, the hemolytic disorder will manifest as *hemolytic anemia*.

Thus the essential pathophysiologic process common to all HAs is an increased red cell turnover. The gold standard for proving that the life span of red cells is reduced (compared with the normal value of ~120 days) is a *red cell survival study*, which can be carried out by labeling the red cells with  $^{51}\text{Cr}$  and measuring residual radioactivity over several days or weeks; however, this classic test is now available in very few centers and is rarely necessary. If the hemolytic event is transient, it does not usually cause any long-term consequences. However, if hemolysis is recurrent or persistent, the increased bilirubin production favors the formation of gallstones. If a considerable proportion of hemolysis takes place in the spleen, as is often the case, splenomegaly may become a prominent feature and hypersplenism may develop, with consequent neutropenia and/or thrombocytopenia.

The increased red cell turnover also has metabolic consequences. In normal subjects, the iron from effete red cells is very efficiently recycled by the body; however, with chronic intravascular hemolysis, the persistent hemoglobinuria will cause considerable iron loss, needing replacement. With chronic extravascular hemolysis, the opposite problem, iron overload, is more common, especially if the patient needs frequent blood transfusions. Chronic iron overload will cause secondary hemochromatosis; this will cause damage, particularly to the liver, eventually leading to cirrhosis, and to the heart muscle, eventually causing heart failure. The increased activity of the bone marrow also entails an increased requirement for erythropoietic factors, particularly folic acid.

### Compensated Hemolysis versus HA

Red cell destruction is a potent stimulus for erythropoiesis, which is mediated by erythropoietin (EPO) produced by the kidney. This mechanism is so effective that in many cases the increased output of red cells from the bone marrow can fully balance an increased destruction of red cells. In such cases we say that hemolysis is *compensated*. The pathophysiology of compensated hemolysis is similar to that just described, except there is no anemia. This notion is important from the diagnostic point of view because a patient with a hemolytic condition, even an inherited one, may present without anemia. It is also important from the point of view of management because compensated hemolysis may become “decompensated”—i.e., anemia may suddenly appear—in certain circumstances—for instance, pregnancy, folate deficiency, renal failure interfering with adequate EPO production, or an acute infection depressing erythropoiesis. Another general feature of chronic HA is seen

when any intercurrent condition depresses erythropoiesis. When this happens, in view of the increased rate of red cell turnover, the effect is predictably much more marked than in a person who does not have hemolysis. The most dramatic example is infection by parvovirus B19, which may cause a rather precipitous fall in hemoglobin, an occurrence sometimes referred to as *aplastic crisis*.

## INHERITED HEMOLYTIC ANEMIAS

There are three essential components in the red cell: (1) hemoglobin, (2) the membrane-cytoskeleton complex, and (3) the metabolic machinery necessary to keep (1) and (2) in working order. Here we discuss diseases of the latter two components. Diseases caused by abnormalities of hemoglobin are discussed in Chap. 8.

### *Hemolytic Anemias Due to Abnormalities of the Membrane-Cytoskeleton Complex*

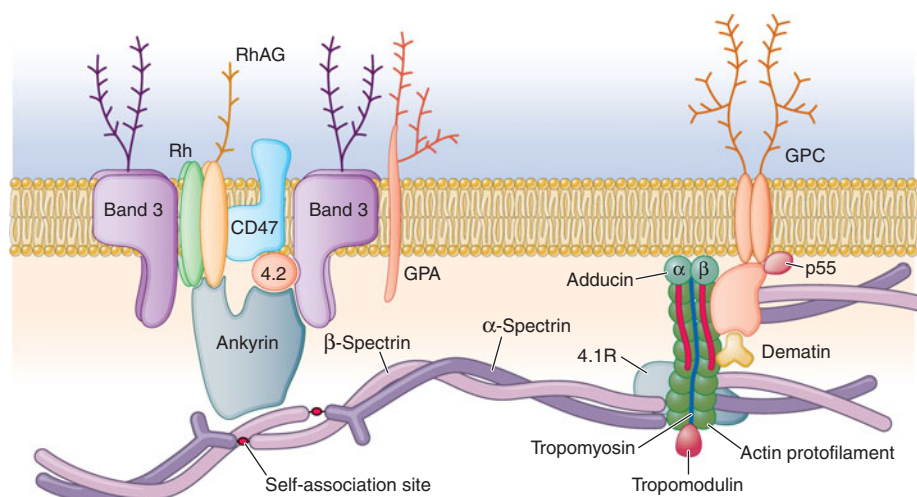
The detailed architecture of the red cell membrane is complex, but its basic design is relatively simple (Fig. 10-2). The lipid bilayer, which incorporates phospholipids and cholesterol, is spanned by a number of proteins that have their hydrophobic transmembrane domains embedded in the membrane. Most of these proteins have hydrophilic domains extending toward both the outside and the inside of the cell. Other proteins are tethered to the membrane through a glycosylphosphatidylinositol (GPI) anchor, and they have only an extracellular domain. These proteins are arranged roughly perpendicular to or lying across the membrane; they include ion channels, receptors for complement components, receptors for other ligands, and some of unknown function. The most abundant of these proteins are glycophorins and the so-called band 3,

an anion transporter. The extracellular domains of many of these proteins are heavily glycosylated, and they carry antigenic determinants that correspond to blood groups. Underneath the membrane, and tangential to it, is a network of other proteins that make up the cytoskeleton. The main cytoskeletal protein is spectrin, the basic unit of which is a dimer of  $\alpha$ -spectrin and  $\beta$ -spectrin. The membrane is physically linked to the cytoskeleton by a third set of proteins (including ankyrin and the so-called band 4.1 and band 4.2), which thus connect these two structures intimately.

The membrane-cytoskeleton complex is indeed so integrated that, not surprisingly, an abnormality of almost any of its components is disturbing or disruptive, causing structural failure, which results ultimately in hemolysis. These abnormalities are almost invariably inherited mutations, and thus diseases of the membrane-cytoskeleton complex belong to the category of inherited hemolytic anemias. Before the red cells lyse, they often exhibit more or less specific morphologic changes that alter the normal biconcave disc shape. Thus most of the diseases in this group have been known for over a century as *hereditary spherocytosis* (HS) and *hereditary elliptocytosis* (HE). Their molecular basis has been elucidated.

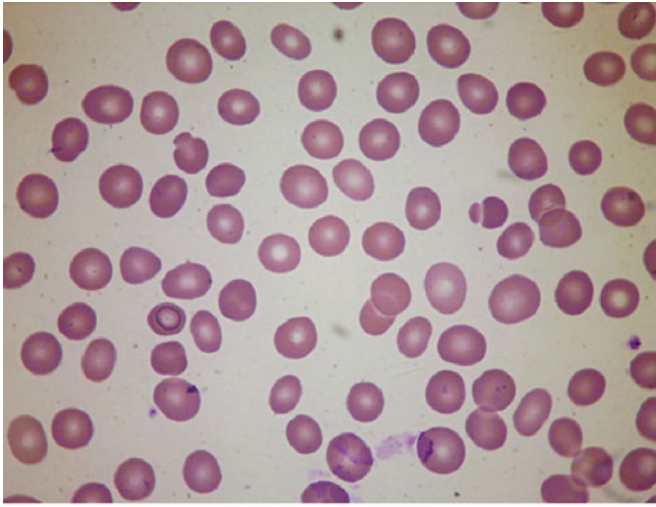
#### Hereditary Spherocytosis

This is a relatively common type of hemolytic anemia, with an estimated frequency of at least 1 in 5000. Its identification is credited to Minkowsky and Chauffard, who at the end of the nineteenth century reported families in whom HS was inherited as an autosomal dominant condition. From this seminal work, HS came to be defined as an inherited form of HA associated with the presence of spherocytes in the peripheral blood (Fig. 10-3A). In addition, *in vitro* studies revealed that the red cells were

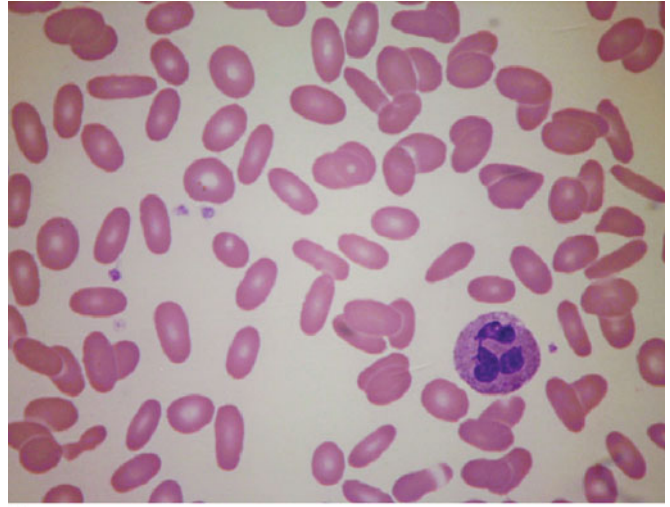


**FIGURE 10-2**

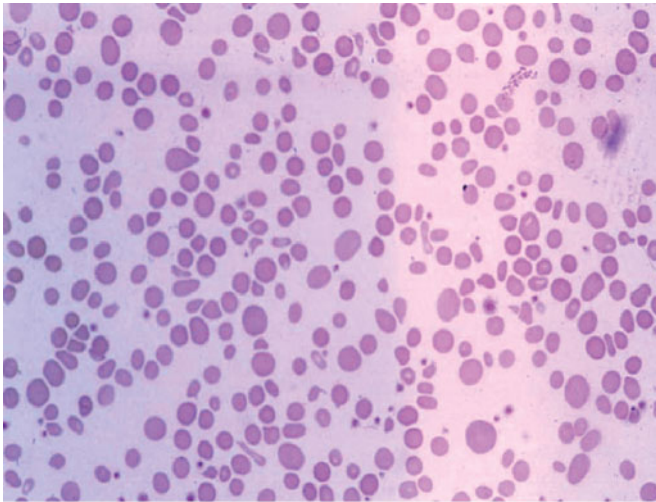
**Diagram of red cell membrane/cytoskeleton.** (For explanation see text.) (From N Young et al: *Clinical Hematology*. Copyright Elsevier, 2006; with permission.)



A



B



C

**FIGURE 10-3**

**Peripheral blood smear from patients with membrane-cytoskeleton abnormalities. A.** Hereditary spherocytosis. **B.** Hereditary elliptocytosis, heterozygote. **C.** Elliptocytosis, with both alleles of the  $\alpha$ -spectrin gene mutated. [From L Luzzatto, in J Gribben and D Pravan (eds): *Molecular Hematology*, 2d edition. Oxford, Blackwell, 2005; with permission.]

abnormally susceptible to lysis in hypotonic media; indeed, the presence of *osmotic fragility* became the main diagnostic test for HS. Today we know that HS, thus defined, is genetically heterogeneous, i.e., it can arise from a variety of mutations in one of several genes (Table 10-3). Whereas classically the inheritance of HS is autosomal dominant (with the patients being heterozygous), some severe forms are instead autosomal recessive (with the patient being homozygous).

#### Clinical Presentation and Diagnosis

The spectrum of clinical severity of HS is broad. Severe cases may present in infancy with severe anemia, whereas mild cases may present in young adults or even later in life. In women, HS is sometimes first diagnosed when anemia is investigated during pregnancy. The main clinical findings are jaundice, an enlarged spleen, and often gallstones; frequently it is the finding of gallstones in a young person that triggers diagnostic investigations.

The variability in clinical manifestations that is observed among patients with HS is largely due to the

different underlying molecular lesions (Table 10-3). Not only are mutations of several genes involved, but individual mutations of the same gene can also give very different clinical manifestations. In milder cases, hemolysis is often compensated (see earlier), and this may cause variation even in the same patient, due to the fact that intercurrent conditions (e.g., infection) cause decompensation. The anemia is usually normocytic, with the characteristic morphology that gives the disease its name. A characteristic feature is an increase in mean corpuscular hemoglobin concentration (MCHC): this is almost the only condition in which high MCHC is seen.

When there is a family history, it is usually easy to suspect the diagnosis, but there may be no family history for at least two reasons: (1) The patient may have a *de novo* mutation, i.e., a mutation that has taken place in a germ cell of one of his or her parents or early after zygote formation; and (2) the patient may have a recessive form of HS (Table 10-3). In most cases the diagnosis is confirmed on the basis of red cell morphology and a test for osmotic fragility, a modified version of which

TABLE 10-3

## INHERITED DISEASES OF THE RED CELL MEMBRANE-CYTOSKELETON

GENE	CHROMOSOMAL LOCATION	PROTEIN PRODUCED	DISEASE(S) WITH CERTAIN MUTATIONS (INHERITANCE)	COMMENTS
<i>SPTA1</i>	1q22-q23	$\alpha$ -Spectrin	HS (recessive) HE (dominant)	Rare. Mutations of this gene account for ~65% of HE. More severe forms may be due to coexistence of an otherwise silent mutant allele.
<i>SPTB</i>	14q23-q24.1	$\beta$ -Spectrin	HS (dominant) HE (dominant)	Rare. Mutations of this gene account for ~30% of HE, including some severe forms.
<i>ANK1</i> <i>SLC4A1</i>	8p11.2 17q21	Ankyrin Band 3 (anion channel)	HS (dominant) HS (dominant)	May account for majority of HS. Mutations of this gene may account for ~25% of HS.
<i>EPB41</i>	1p33-p34.2	Band 4.1	Southeast Asian ovalocytosis (dominant) HE (dominant)	Polymorphic mutation (deletion of 9 amino acids); clinically asymptomatic; protective against <i>Plasmodium falciparum</i> . Mutations of this gene account for ~5% of HE, mostly with prominent morphology but no hemolysis in heterozygotes; severe hemolysis in homozygotes.
<i>EPB42</i>	15q15-q21	Band 4.2	HS (recessive)	Mutations of this gene account for ~3% of HS.
<i>RHAG</i>	6p21.1-p11	Rhesus antigen	Chronic nonspherocytic hemolytic anemia	Very rare; associated with total loss of all Rh antigens.

**Note:** HS, hereditary spherocytosis; HE, hereditary elliptocytosis.

is called the “pink test.” In some cases a definitive diagnosis can be obtained only by molecular studies demonstrating a mutation in one of the genes underlying HS. This is carried out only in laboratories with special expertise in this area.

### **Rx Treatment:** **HEREDITARY SPHEROCYTOSIS**

There is currently no treatment aimed at the cause of HS; no way has yet been found to correct the basic defect in the membrane-cytoskeleton structure. However, it has been apparent for a long time that the spleen plays a special role in HS, through a dual mechanism. On one hand, as in many other HAs, the spleen itself is a major site of destruction; on the other hand, transit through the splenic circulation makes the defective red cells more spherocytic and therefore accelerates their demise, even though lysis may take place elsewhere. For these reasons, splenectomy has long been regarded as a prime, almost obligatory therapeutic measure in HS. However, it also increases the risk of certain infections, and therefore current guidelines (not evidence-based) are as follows.

1. Avoid splenectomy in mild cases.
2. Delay splenectomy until at least 4 years of age, after the risk of severe sepsis has peaked.
3. Antipneumococcal vaccination before splenectomy is imperative, whereas penicillin prophylaxis post-splenectomy is controversial.
4. HS patients often may require cholecystectomy. It used to be considered mandatory to combine this procedure with splenectomy, but this may not be always necessary.

### **Hereditary Elliptocytosis**

HE is at least as heterogeneous as HS, both from the genetic (Table 10-3) and from the clinical point of view. Again it is the shape of the red cells that gives the name to these conditions, but there is no direct correlation between elliptocytic morphology and clinical severity. In fact, some mild or even asymptomatic cases may have nearly 100% elliptocytes, whereas in severe cases, all sorts of bizarre poikilocytes may predominate (Fig. 10-3B, C). Clinical features and recommended management are similar to those for HS. Although the spleen may not have the specific role it has in HS, in severe cases splenectomy may be beneficial. The prevalence of HE

116 causing clinical disease is similar to that of HS. However, an asymptomatic form, referred to as *Southeast Asian ovalocytosis*, has a frequency of up to 7% in certain populations, presumably as a result of malaria selection.

### Stomatocytosis

This rare condition with autosomal dominant inheritance draws its name (mouth-like cells) from the fact that the normally round-shaped central pallor of red cells is replaced by a linear-shaped central pallor. Hemolysis is usually relatively mild. Splenectomy is contraindicated because it has been followed in a majority of cases by severe thromboembolic complications.

### Enzyme Abnormalities

When there is an important defect in the membrane or in the cytoskeleton, hemolysis is a direct consequence of the fact that the very structure of the red cell is abnormal. Instead, when one of the enzymes is defective, the consequences will depend on the precise role of that enzyme in the metabolic machinery of the red cell, which, in its first approximation, has two important functions: (1) to provide energy in the form of ATP, and (2) to prevent oxidative damage to hemoglobin and to other proteins.

### Abnormalities of the Glycolytic Pathway

(Fig. 10-1) Because red cells, in the course of their differentiation, have sacrificed not only their nucleus and their ribosomes but also their mitochondria, they rely exclusively on the anaerobic portion of the glycolytic pathway for producing energy in the form of ATP. Most of the ATP is required by the red cell for cation transport against a concentration gradient across the membrane. If this fails, due to a defect of any of the enzymes of the glycolytic pathway, the result is hemolytic disease.

### Pyruvate Kinase Deficiency

Abnormalities of the glycolytic pathway are all inherited and all rare (Table 10-4). Among them, deficiency of pyruvate kinase (PK) is the least rare, with an estimated prevalence of 1:10,000. The clinical picture is that of an HA that often presents in the newborn with neonatal jaundice; the jaundice persists and is usually associated with a very high reticulocytosis. The anemia is of variable severity; sometimes it is so severe as to require regular blood transfusions; sometimes it is mild, bordering on a nearly compensated hemolytic disorder. As a result, the diagnosis may be delayed, and in some cases it is made in young adults—for instance, in a woman during her first pregnancy, when the anemia may get worse. In part the delay in diagnosis is due to the fact that the anemia is remarkably well-tolerated because the metabolic block at the last step in glycolysis causes an increase in bisphosphoglycerate (or DPG), a major effector of the hemoglobin-oxygen dissociation curve. Thus the oxygen delivery to the tissues is increased.

### Rx Treatment: PYRUVATE KINASE DEFICIENCY

Management of PK deficiency is mainly supportive. In view of the marked increase in red cell turnover, oral folic acid supplements should be given constantly. Blood transfusion should be used as necessary, and iron chelation may have to be added if the blood transfusion requirement is high enough to cause iron overload. In these patients, who have more severe disease, splenectomy may be beneficial. There is a single case report of curative treatment of PK deficiency by bone marrow transplantation from an HLA-identical PK normal sib: this seems a viable option for severe cases when a sib donor is available.

### Other Glycolytic Enzyme Abnormalities

All of these defects are rare to very rare (Table 10-4), and all cause HA of varying degrees of severity. It is not unusual for the presentation to be in the guise of severe neonatal jaundice, which may require exchange transfusion; if the anemia is less severe, it may present later in life or may even remain asymptomatic and be detected incidentally when a blood count is done for unrelated reasons. The spleen is often enlarged. When other systemic manifestations occur, they involve the central nervous system, sometimes entailing severe mental retardation (particularly in the case of triose phosphate isomerase deficiency) or the neuromuscular system, or both. The *diagnosis* of HA is usually not difficult, thanks to the triad of normo-macrocytic anemia, reticulocytosis, and hyperbilirubinemia. Enzymopathies should be considered in the differential diagnosis of any chronic Coombs-negative HA. In most cases of glycolytic enzymopathies, the morphologic abnormalities of red cells characteristically seen in membrane disorders are absent. A definitive diagnosis can be made only by demonstrating the deficiency of an individual enzyme by quantitative assays carried out in only a few specialized laboratories. If a particular molecular abnormality is already known in the family, then of course one could test directly for that defect at the DNA level, bypassing the need for enzyme assays.

### Abnormalities of Redox Metabolism

#### G6PD Deficiency

Glucose 6-phosphate dehydrogenase (G6PD) is a house-keeping enzyme critical in the redox metabolism of all aerobic cells (Fig. 10-4). In red cells, its role is even more critical because it is the only source of reduced nicotinamide adenine dinucleotide phosphate (NADPH), which, directly and via reduced glutathione (GSH), defends these cells against oxidative stress. G6PD deficiency is a prime example of an HA due to interaction

TABLE 10-4


## RED CELL ENZYME ABNORMALITIES CAUSING HEMOLYSIS

	ENZYME (ACRONYM)	CHROMOSOMAL LOCATION	PREVALENCE OF ENZYME DEFICIENCY (RANK)	CLINICAL MANIFESTATIONS EXTRA-RED CELL	COMMENTS
Glycolytic pathway	<i>Hexokinase</i> (HK)	10q22	Very rare		Other isoenzymes known.
	<i>Glucose 6-phosphate isomerase</i> (G6PI)	19q31.1	Rare (4)	NM, CNS	
	<i>Phosphofructokinase</i> (PFK)	12q13	Very rare	Myopathy	
	<i>Aldolase</i>	16q22-24	Very rare		
	<i>Triose phosphate isomerase</i> (TPI)	12p13	Very rare	CNS (severe), NM	
	<i>Glyceraldehyde 3-phosphate dehydrogenase</i> (GAPD)	12p13.31–p13.1	Very rare	Myopathy	
	<i>Diphosphoglycerate mutase</i> (DPGM)	7q31-q34	Very rare		Erythrocytosis rather than hemolysis.
	<i>Phosphoglycerate kinase</i> (PGK)	Xq13	Very rare	CNS, NM	May benefit from splenectomy.
	<i>Pyruvate kinase</i> (PK)	1q21	Rare (2)		May benefit from splenectomy.
Redox	<i>Glucose 6-phosphate dehydrogenase</i> (G6PD)	Xq28	Common (1)	Very rarely granulocytes	In almost all cases only AHA from exogenous trigger.
	<i>Glutathione synthase</i>	20q11.2	Very rare	CNS	
	<i>γ-Glutamylcysteine synthase</i>	6p12	Very rare	CNS	
	<i>Cytochrome b5 reductase</i>	22q13.31–qter	Rare	CNS	Methemoglobinemia rather than hemolysis.
Nucleotide metabolism	<i>Adenylate kinase</i> (AK)	9q34.1	Very rare	CNS	
	<i>Pyrimidine 5'-nucleotidase</i> (P5N)	3q11–q12	Rare (3)		May benefit from splenectomy.

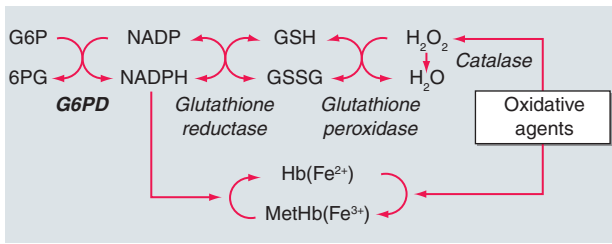
**Note:** CNS, central nervous system; AHA, acquired hemolytic anemia.

between an intracorporeal and an extracorporeal cause because in most cases hemolysis is triggered by an exogenous agent. Although in G6PD-deficient subjects there is a decrease in G6PD activity in most tissues, this is less marked than in red cells, and it does not seem to produce symptoms.

## GENETIC CONSIDERATIONS

 The *G6PD* gene is X-linked, which has important implications. First, because males have only one *G6PD* gene (i.e., they are hemizygous for this gene), they must be either normal or G6PD-deficient. By contrast, females, having two *G6PD* genes, can be normal,

deficient (homozygous), or intermediate (heterozygous). As a result of the phenomenon of X-chromosome inactivation, heterozygous females are genetic mosaics, with a highly variable ratio of G6PD-normal to G6PD-deficient cells and an equally variable degree of clinical expression; some heterozygotes can be just as affected as hemizygous males. The enzymatically active form of G6PD is either a dimer or a tetramer of a single protein subunit of 514 amino acids. G6PD-deficient subjects have been found invariably to have mutations in the coding region of the *G6PD* gene. Almost all of the 140 different mutations known are single missense point mutations, entailing single amino acid replacements in the G6PD protein. In most cases these mutations cause

**FIGURE 10-4**

**Diagram of redox metabolism in the red cell.** G6P, glucose 6-phosphate; 6PG, 6-phosphogluconate; G6PD, glucose 6-phosphate dehydrogenase; GSH, reduced glutathione; GSSG, oxidized glutathione; Hb, hemoglobin; MetHb, methemoglobin; NADP, nicotinamide adenine dinucleotide phosphate; NADPH, reduced nicotinamide adenine dinucleotide phosphate.

G6PD deficiency by decreasing the *in vivo* stability of the protein, and thus the physiologic decrease in G6PD activity that takes place with red cell aging is greatly accelerated. In some cases an amino acid replacement can also affect the catalytic function of the enzyme.

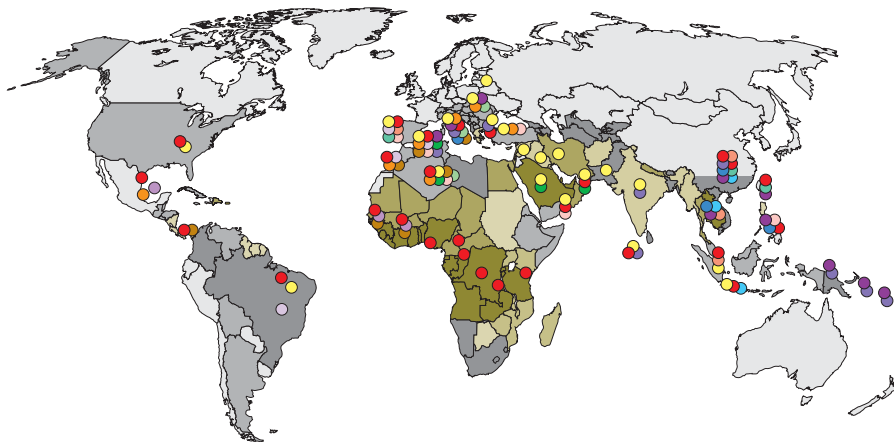
Among the mutations, those underlying *chronic nonspherocytic hemolytic anemia* (CNSHA; see later) are a discrete subset. This much more severe clinical phenotype can be ascribed in some cases to adverse qualitative changes (for instance, a decreased affinity for the substrate, glucose 6-phosphate); or simply to the fact that the enzyme deficit is more extreme because it is more unstable. For instance, a cluster of mutations map at or near the dimer interface, and they prevent dimer formation.

### Epidemiology

G6PD deficiency is widely distributed in tropical and subtropical parts of the world (Africa, Southern Europe, the Middle East, Southeast Asia, and Oceania) (Fig. 10-5) and wherever people from those areas have migrated; a conservative estimate is that at least 400 million people have a G6PD-deficiency gene. In several of these areas, the frequency of a G6PD-deficiency gene may be as high as 20% or more. It would be quite extraordinary for a trait that causes significant pathology to spread widely and reach high frequencies in many populations without conferring some biologic advantage. Indeed, G6PD is one of the best characterized examples of genetic polymorphisms in the human species. Clinical field studies and *in vitro* experiments strongly support the view that G6PD deficiency has been selected by *Plasmodium falciparum* malaria, by virtue of the fact that it confers a relative resistance against this highly lethal infection. Whether this protective effect is exerted mainly in hemizygous males or in females heterozygous for G6PD deficiency is still not clear. Different G6PD variants underlie G6PD deficiency in different parts of the world. Some of the more widespread variants are G6PD Mediterranean on the shores of the Mediterranean Sea, in the Middle East, and in India; G6PD A- in Africa and in Southern Europe; G6PD Vianchan and G6PD Mahidol in Southeast Asia; G6PD Canton in China; and G6PD Union worldwide. The heterogeneity of polymorphic G6PD variants is proof of their independent origin, and it supports the notion that they have been selected by a common environmental agent, in keeping with the concept of convergent evolution.

### Clinical Manifestations

The vast majority of people with G6PD deficiency remain clinically asymptomatic throughout their lifetime.

**FIGURE 10-5**

**Epidemiology of G6PD deficiency throughout the world.** The different shadings indicate increasingly high levels of prevalence, up to ~20%; the different colored symbols indicate individual genetic variants of G6PD, each one having a

different mutation. [From L Luzzatto et al in C Scriver et al (eds): *The Metabolic & Molecular Bases of Inherited Disease*, 8th edition. New York, McGraw-Hill, 2001.]

However, all of them have an increased risk of developing neonatal jaundice (NNJ) and a risk of developing acute HA when challenged by a number of oxidative agents. NNJ related to G6PD deficiency is very rarely present at birth: the peak incidence of clinical onset is between day 2 and day 3, and in most cases the anemia is not severe. However, NNJ can be very severe in some G6PD-deficient babies, especially in association with prematurity, infection, and/or environmental factors (such as naphthalene-camphor balls used in babies' bedding and clothing). In these cases, if inadequately managed, NNJ associated with G6PD deficiency can produce kernicterus and permanent neurologic damage.

Acute HA can develop as a result of three types of triggers: (1) fava beans, (2) infections, and (3) drugs (Table 10-5). Typically, a hemolytic attack starts with malaise, weakness, and abdominal or lumbar pain. After an interval of several hours to 2–3 days, the patient develops jaundice and often dark urine, due to hemoglobinuria (Table 10-6). The onset can be extremely abrupt, especially with favism in children. The anemia is moderate to extremely severe, usually normocytic and normochromic, and due partly to intravascular hemolysis; hence it is associated with hemoglobinemia, hemoglobinuria, and low or absent plasma haptoglobin. The blood film shows anisocytosis, polychromasia, and spherocytes (Fig. 10-6). The most typical feature is the presence of bizarre poikilocytes with red cells that appear to have unevenly distributed hemoglobin (hemighosts) and red cells that appear to have had parts of them bitten away (bite cells or blister cells). A classic test, now rarely carried out, is supravital staining with methyl violet, which, if done promptly, reveals the presence of Heinz bodies, consisting of precipitates of denatured

hemoglobin and regarded as a signature of oxidative damage to red cells (except for the rare occurrence of an unstable hemoglobin). LDH is high and so is the unconjugated bilirubin, indicating that there is also extravascular hemolysis. The most serious threat from acute HA in adults is the development of acute renal failure (exceedingly rare in children). Once the threat of acute anemia is over, and in the absence of comorbidity, full recovery from acute HA associated with G6PD deficiency is the rule.

A very small minority of subjects with G6PD deficiency have CNSHA of variable severity. The patient is always a male, usually with a history of NNJ, who may present with anemia or unexplained jaundice, or because of gallstones later in life. The spleen may be enlarged. The severity of anemia ranges from borderline to transfusion-dependent. The anemia is usually normo-macrocytic, with reticulocytosis. Bilirubin and LDH are increased. Although hemolysis is, by definition, chronic in these patients, they are also vulnerable to acute oxidative damage, and therefore the same agents (see Table 10-5) that can cause acute HA in people with the ordinary type of G6PD deficiency will cause severe exacerbations in people with the severe form of G6PD deficiency. In some cases of CNSHA, the deficiency of G6PD is so severe in granulocytes that it becomes rate-limiting for their oxidative burst, with consequent increased susceptibility to bacterial infections.

### Laboratory Diagnosis

The suspicion of G6PD deficiency can be confirmed by semiquantitative methods often referred to as screening tests, which are suitable for population studies and can correctly classify male subjects, in the steady state, as

**TABLE 10-5**

#### DRUGS THAT CARRY RISK OF CLINICAL HEMOLYSIS IN PERSONS WITH G6PD DEFICIENCY

	DEFINITE RISK	POSSIBLE RISK	DOUBTFUL RISK
<i>Antimalarials</i>	Primaquine Dapsone/chlorproguanil	Chloroquine	Quinine
<i>Sulphonamides/sulphones</i>	Sulphametoxazole Others Dapsone	Sulfasalazine Sulfadimidine	Sulfisoxazole Sulfadiazine
<i>Antibacterial/antibiotics</i>	Cotrimoxazole Nalidixic acid Nitrofurantoin Niridazole	Ciprofloxacin Norfloxacin	Chloramphenicol <i>p</i> -Aminosalicylic acid
<i>Antipyretic/analgesics</i>	Acetanilide Phenazopyridine (Pyridium)	Acetylsalicylic acid high dose (>3 g/d)	Acetylsalicylic acid <3 g/d Acetaminophen Phenacetin
<i>Other</i>	Naphthalene Methylene blue	Vitamin K analogues Ascorbic acid >1 g Rasburicase	Doxorubicin Probenecid



## DISEASES/CLINICAL SITUATIONS WITH PREDOMINANTLY INTRAVASCULAR HEMOLYSIS

	ONSET/TIME COURSE	MAIN MECHANISM	APPROPRIATE DIAGNOSTIC PROCEDURE	COMMENTS
Mismatched blood transfusion	Abrupt	Nearly always ABO incompatibility	Repeat cross match	
Paroxysmal nocturnal hemoglobinuria (PNH)	Chronic with acute exacerbations	Complement (C)-mediated destruction of CD59(-) red cells	Flow cytometry to display a CD59(-) red cell population	Exacerbations due to C activation through any pathway
Paroxysmal cold hemoglobinuria (PCH)	Acute	Immune lysis of normal red cells	Test for Donath-Landsteiner antibody	Often triggered by viral infection
Septicemia	Very acute	Exotoxins produced by <i>Clostridium perfringens</i>	Blood cultures	Other organisms may be responsible
Microangiopathic	Acute or chronic	Red cell fragmentation	Red cell morphology on blood smear	Different causes ranging from endothelial damage to hemangioma to leaky prosthetic heart valve
March hemoglobinuria Favism	Abrupt Acute	Mechanical destruction Destruction of older fraction of G6PD-deficient red cells	Targeted history taking G6PD assay	Triggered by ingestion of large dish of fava beans; but trigger can be infection or drug instead

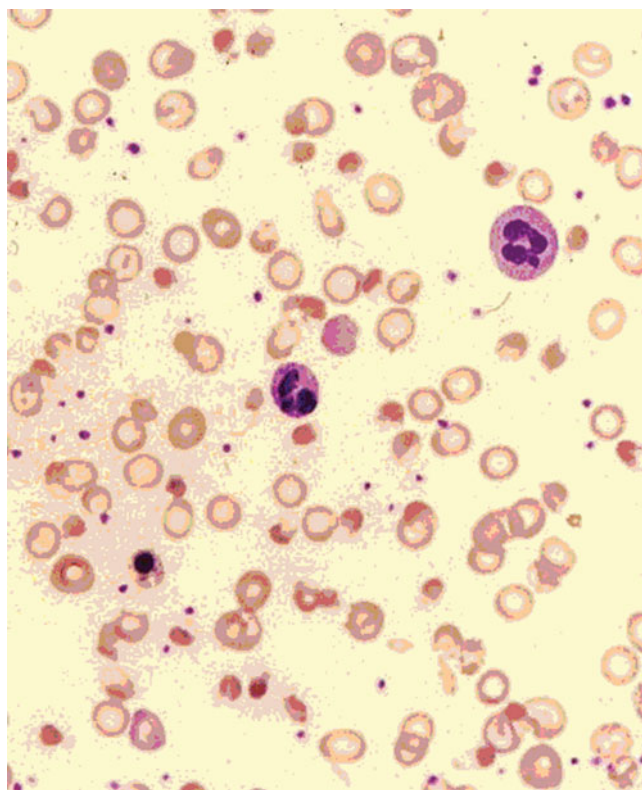


FIGURE 10-6

Peripheral blood smear from a 5-year-old G6PD-deficient boy with acute favism.

G6PD-normal or G6PD-deficient. However, in clinical practice a diagnostic test is usually needed when the patient has had a hemolytic attack: this implies that the oldest, most G6PD-deficient red cells have been selectively destroyed, and young red cells, having higher G6PD activity, are being released into the circulation. Under these conditions, only a quantitative test can give a definitive result. In males this test identifies normal hemizygotes and G6PD-deficient hemizygotes; among females some heterozygotes are missed, but those who are at most risk of hemolysis are identified.

#### **Rx Treatment:** **G6PD DEFICIENCY**

The acute HA of G6PD deficiency is largely preventable by avoiding exposure to triggering factors of previously screened subjects. Of course, the practicability and cost-effectiveness of screening depends on the prevalence of G6PD deficiency in each individual community. Favism is entirely preventable by not eating fava beans. Prevention of drug-induced hemolysis is possible in most cases by choosing alternative drugs. When acute HA develops and once its cause is recognized, no specific treatment is needed in most cases. However, if the anemia is severe, it may be a medical emergency, especially in children,

requiring immediate action, including blood transfusion. If acute renal failure develops, hemodialysis may be necessary, but if there is no previous kidney disease, full recovery is the rule. The management of NNJ associated with G6PD deficiency is no different from that of NNJ due to other causes.

In cases with CNSHA, if the anemia is not severe, regular folic acid supplements and regular hematologic surveillance will suffice. It will be important to avoid exposure to potentially hemolytic drugs, and blood transfusion may be indicated when exacerbations occur, mostly in concomitance with intercurrent infection. In rare patients, regular blood transfusions may be required; appropriate iron chelation should be instituted in such cases. Unlike in hereditary spherocytosis, there is no evidence of selective red cell destruction in the spleen: however, in practice splenectomy has proven beneficial in severe cases.

### Other Abnormalities of the Redox System

As mentioned earlier, GSH is a key player in the defense against oxidative stress (Fig. 10-4). Inherited defects of GSH metabolism are exceedingly rare, but each one of them can give rise to chronic HA (Table 10-4). A rare, peculiar, usually self-limited severe HA of the first month of life, called *infantile poikilocytosis*, may be associated with deficiency of glutathione peroxidase (GSHPx) due not to an inherited abnormality but to transient nutritional deficiency of selenium, an element essential for the activity of GSHPx.

### Pyrimidine 5'-Nucleotidase (P5N) Deficiency

P5N is a key enzyme in the catabolism of nucleotides arising from the degradation of nucleic acids that takes place in the final stages of red cell maturation. How exactly its deficiency causes HA is not well understood, but a highly distinctive feature of this condition is a morphologic abnormality of the red cells known as *basophilic stippling*. The condition is rare, but it probably ranks third in frequency among red cell enzyme defects (after G6PD deficiency and PK deficiency). The anemia is lifelong, of variable severity, and may benefit from splenectomy.

### Familial Hemolytic Uremic Syndrome (HUS)

This disorder is unique because, now that its basis has been elucidated, we can clearly see that hemolysis is due to an inherited defect, but this is external to red cells. HUS is defined as a microangiopathic hemolytic anemia with fragmented erythrocytes in the peripheral blood smear, thrombocytopenia (usually mild), and acute renal failure. An infection is usually the trigger of the syndrome, which tends to recur. When it does, the prognosis is

serious. Although familial HUS is rare, studies of affected members from >100 families have revealed numerous mutations in any of three complement regulatory proteins: membrane cofactor protein, factor H, and factor I. It is thought that when complement is activated through the alternative pathway following damage to endothelial cells in the kidney, one of the results will be brisk hemolysis. Thus the much more common Shiga toxin-related HUS can be regarded as a phenocopy of familial HUS.

## ACQUIRED HEMOLYTIC ANEMIA

### Mechanical Destruction of Red Cells

Although red cells are characterized by the remarkable deformability that enables them to squeeze through capillaries narrower than themselves thousands of times in their lifetime, there are at least two situations in which they succumb to shear, if not to wear and tear; the result is intravascular hemolysis resulting in hemoglobinuria. One situation, *march hemoglobinuria*, is acute and self-inflicted. Why a marathon runner may sometimes develop this complication and at another time does not is unclear (perhaps the footwear needs attention). A similar syndrome may develop after prolonged barefoot ritual dancing or vigorous bongo drumming. The other situation, which has been called *microangiopathic hemolytic anemia* (Table 10-6), is chronic and iatrogenic; it takes place in patients with prosthetic heart valves, especially when paraprosthetic regurgitation is present. If the hemolysis consequent to mechanical trauma to the red cells is mild, and provided the supply of iron is adequate, it may be largely compensated. If more than mild anemia develops, reintervention to correct regurgitation may be required.

### Toxic Agents and Drugs

A number of chemicals with oxidative potential, whether medicinal or not, can cause hemolysis even in people who are not G6PD-deficient (see earlier). Examples are hyperbaric oxygen (or 100% oxygen), nitrates, chlorates, methylene blue, dapsone, cisplatin, and numerous aromatic (cyclic) compounds. Other chemicals may be hemolytic through nonoxidative, largely unknown mechanisms; examples are arsine, stibine, copper, and lead. The HA caused by lead poisoning is characterized by basophilic stippling: it is in fact a phenocopy of that seen in P5N deficiency (see earlier), suggesting it is mediated at least in part by lead inhibiting this enzyme.

In these cases hemolysis appears to be mediated by a direct chemical action on red cells. But drugs can cause hemolysis through at least two other mechanisms. (1) A drug can behave as a hapten and induce antibody production. In rare subjects this happens, for instance, with penicillin. Upon a subsequent exposure, red cells are caught

122 as innocent bystanders in the reaction between penicillin and antipenicillin antibodies. Hemolysis will subside as soon as penicillin administration is stopped. (2) A drug can trigger, perhaps through mimicry, the production of an antibody against a red cell antigen. The best known example is methyl dopa, an antihypertensive agent no longer in use, which in a small fraction of patients stimulated the production of the Rhesus antibody anti-e. In patients who have this antigen, the anti-e is a true autoantibody, which would then cause an autoimmune HA (see later). Usually HA gradually subsides once methyl dopa is discontinued.

Nucleosides may also cause hemolysis by depletion of ATP. Ribavirin, a drug used in the treatment of hepatitis C, causes the destruction of red cells through this mechanism. Severe intravascular hemolysis can be caused by the venom of certain snakes (cobras and vipers), and HA can also follow spider bites.

### Infection

By far the most frequent infectious cause of hemolytic anemia in endemic areas is malaria. In other parts of the world, the most frequent cause is probably Shiga toxin-producing *Escherichia coli* O157:H7, now recognized as the main etiologic agent of HUS, more common in children than in adults. Life-threatening intravascular hemolysis due to a toxin with lecithinase activity occurs with

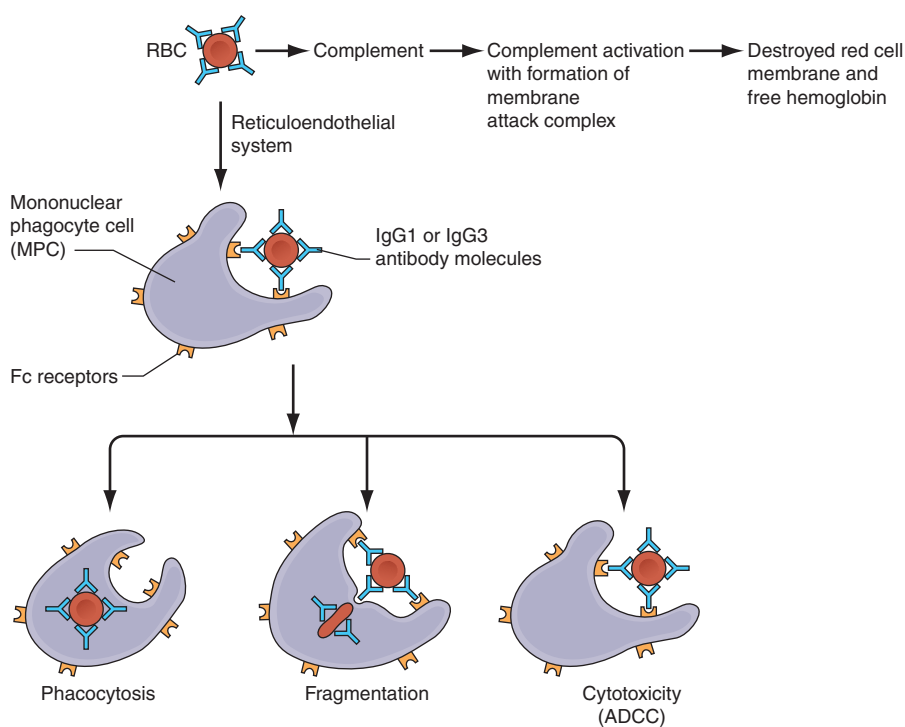
*Clostridium perfringens* sepsis (Table 10-6), particularly with open wounds, following septic abortion, or as a disastrous accident due to a contaminated blood unit. Occasionally HA is seen, especially in children, with sepsis or endocarditis from a variety of organisms.

### Autoimmune Hemolytic Anemia (AIHA)

Except for countries where malaria is endemic, AIHA is the most common form of acquired hemolytic anemia. In fact, not quite appropriately, the two phrases are sometimes used synonymously.

#### Pathophysiology

AIHA is caused by an autoantibody directed against a red cell antigen, i.e., a molecule present on the surface of red cells. The autoantibody binds to the red cells. Once a red cell is coated by antibody, one or more mechanisms will destroy it. In most cases the Fc portion of the antibody will be recognized by the Fc receptor of macrophages, and this will trigger erythrophagocytosis (Fig. 10-7). Thus destruction of red cells will take place wherever macrophages are abundant—i.e., in the spleen, liver, and bone marrow. Because of the special anatomy of the spleen, this organ is particularly efficient in trapping antibody-coated red cells, and often this is the predominant site of red cell destruction. Although in severe cases even circulating monocytes can take part in this



**FIGURE 10-7** Mechanism of antibody-mediated immune destruction of red cells. (From N Young et al: *Clinical Hematology*. Copyright Elsevier, 2006; with permission.)

process, most of the phagocytosis-mediated red cell destruction takes place in the spleen and liver, and it is therefore called *extravascular hemolysis*. In some cases the nature of the antibody is such (usually an IgM antibody) that the antigen-antibody complex on the surface of red cells is able to activate complement (C). As a result, a large amount of membrane attack complex will form, and the red cells may be destroyed directly, known as *intravascular hemolysis*.

### Clinical Features

The onset of AIHA is very often abrupt and can be dramatic. The hemoglobin level can drop, within days, to as low as 4 g/dL; the massive red cell removal will produce jaundice, and often the spleen will be enlarged. When this triad is present, the suspicion of AIHA must be high. When hemolysis is (in part) intravascular, the telltale sign will be hemoglobinuria, which the patient may report or for which the physician must test. The diagnostic test for AIHA is the antiglobulin test worked out in 1945 by R.R.A. Coombs and known since by his name. The beauty of this test is that it directly detects the pathogenic mediator of the disease, i.e., the presence of antibody on the red cells themselves. When the test is positive, it clinches the diagnosis; when it is negative, the diagnosis is unlikely. However, the sensitivity of the Coombs test varies depending on the technology that is used, and in doubtful cases a repeat in a specialized lab is advisable; the term *Coombs-negative AIHA* is a last resort. In some cases the autoantibody has a defined identity: it may be specific for a Rhesus system antigen (often anti-e). In many cases it is regarded as “unspecific” because it reacts with virtually all types of red cells.

As in autoimmune diseases in general, the real cause of AIHA remains obscure. However, from the clinical point of view, an important feature is that AIHA can appear to be isolated, or it can develop as part of a more general autoimmune disease, particularly systemic lupus erythematosus (SLE), of which sometimes it may be the first manifestation. Therefore, when AIHA is diagnosed, a full screen for autoimmune disease is imperative. In some cases AIHA can be associated, on first presentation or subsequently, with autoimmune thrombocytopenia (Evans’s syndrome).

### **Rx** Treatment: AUTOIMMUNE HEMOLYTIC ANEMIA

The first-line treatment of AIHA is glucocorticoids. A dose of prednisone, 1 mg/kg per day, will cause a prompt remission in at least half of the cases. Whereas some patients are apparently cured, relapses are not uncommon. For patients who do not respond, and for

those who have relapsed, second-line treatment measures include long-term immunosuppression with low-dose prednisone, azathioprine, or cyclosporine. In patients whose AIHA has become chronic, and sometimes even earlier, splenectomy is a viable option: although it does not cure the disease, it can produce significant benefit by removing a major site of hemolysis, thus improving the anemia and/or reducing the need for immunosuppressive agents. Most of the management of AIHA is not evidence-based. However, the anti-CD20 antibody rituximab has produced responses. Anecdotal reports suggest response to intravenous immunoglobulin. In severe refractory cases, either auto- or allohematopoietic stem cell transplantation has been used, sometimes successfully.

Severe acute AIHA can be a medical emergency. The immediate treatment almost invariably includes transfusion of red cells. This may pose a special problem because if the antibody involved is “unspecific,” all the blood units cross-matched will be incompatible. In these cases it is often correct, paradoxically, to transfuse incompatible blood, the rationale being that the transfused red cells will be destroyed no less but no more than the patient’s own red cells, and in the meantime the patient stays alive. Clearly this rather unique situation requires good liaison and understanding between the clinical unit treating the patient and the blood transfusion/serology lab.

### Paroxysmal Cold Hemoglobinuria (PCH)

PCH is a rather rare form of AIHA occurring mostly in children, usually triggered by a viral infection, usually self-limited, and characterized by involvement of the so-called Donath-Landsteiner antibody. In vitro this antibody has unique serologic features: it has anti-P specificity and binds to red cells only at a low temperature (optimally at 4°C), but when the temperature is shifted to 37°C, lysis of red cells takes place in the presence of complement. Consequently, in vivo there is intravascular hemolysis, resulting in hemoglobinuria. Clinically, the differential diagnosis must include other causes of hemoglobinuria (Table 10-2), but the presence of the Donath-Landsteiner antibody will prove PCH. Active supportive treatment, including blood transfusion, is needed to control the anemia; subsequently, recovery is the rule.

### Cold Agglutinin Disease (CAD)

This designation is used for a form of chronic AIHA that usually affects the elderly and has special clinical and pathologic features. First, the term *cold* refers to the fact that the autoantibody involved reacts with red cells poorly or not at all at 37°C, whereas it reacts strongly at

124 lower temperatures.<sup>1</sup> As a result, hemolysis is more prominent the more the body is exposed to cold. The antibody is usually an IgM, usually has an anti-I specificity (the I antigen is present on the red cells of almost everyone), and may have a very high titer (1:100,000 or more has been observed). Second, the antibody is produced by an expanded clone of B lymphocytes, and sometimes its concentration in the plasma is high enough to show up as a spike in plasma protein electrophoresis—i.e., as a monoclonal gammopathy. Third, because the antibody is IgM, CAD is related to Waldenström macroglobulinemia (WM; Chap. 16), although in most cases the other clinical features of this disease are not present. Thus CAD must be regarded as a form of WM, i.e., as a low-grade mature B-cell lymphoma that manifests at an earlier stage because the unique biologic properties of the IgM that it produces give the clinical picture of chronic HA.

In mild forms of CAD, avoidance of exposure to cold may be all that is needed to enable the patient to live with a reasonably comfortable quality of life, but in more severe forms the management of CAD is not easy. Blood transfusion is not very effective because donor red cells are I-positive and will be removed rapidly. Immunosuppressive/cytotoxic treatment with prednisone, azathioprine, or cyclophosphamide can reduce the antibody titer, but clinical efficacy is limited, and in view of the chronic nature of the disease, the side effects may prove unacceptable. Plasma exchange is a rational approach, but it is laborious and must be carried out, in some patients, at very frequent intervals. The picture may be changing because in a recent study, rituximab gave a response rate of 60%. Given the long clinical course of CAD, it remains to be seen with what periodicity this agent will need to be administered.


### **Paroxysmal Nocturnal Hemoglobinuria (PNH)**

PNH is an acquired chronic HA characterized by persistent intravascular hemolysis subject to recurrent exacerbations (Table 10-6; Fig. 10-8). In addition to hemolysis, there is often pancytopenia and a risk of venous thrombosis. This triad makes PNH a truly unique clinical condition; however, when not all of these three features are manifest on presentation, the diagnosis is often delayed, although it can be always made by appropriate laboratory investigations (see later).

<sup>1</sup>In the past, this type of antibody was called a cold antibody, whereas the antibodies causing the more common form of AIHA were called warm antibodies.



**FIGURE 10-8**  
Consecutive urine samples from a patient with paroxysmal nocturnal hemoglobinuria (PNH). The variation in the severity of hemoglobinuria within hours is probably unique to this condition.

 PNH has about the same frequency in men and women, and it is encountered in all populations throughout the world, but it is a rare disease: its prevalence is 1–5 per million (it may be somewhat less rare in Southeast Asia and in the Far East). There is no evidence of inherited susceptibility. PNH has never been reported as a congenital disease, but it can present in small children or in people in their seventies, although most patients are young adults.

#### **Clinical Features**

The patient may seek medical attention because one morning she or he has passed “blood instead of urine.” This distressing event may be regarded as the classical presentation; however, more frequently this symptom is not noticed or is suppressed. Indeed, the patient often presents simply as a problem in the differential diagnosis of *anemia*, whether symptomatic or discovered incidentally. Sometimes the anemia is associated from the outset with neutropenia or thrombocytopenia, or both. Some patients may present with recurrent attacks of severe abdominal pain, defying a specific diagnosis and eventually found to be caused by thrombosis. When thrombosis affects the hepatic veins, it may produce acute hepatomegaly and ascites, i.e., a full-fledged Budd-Chiari syndrome, which, in the absence of liver disease, ought to raise the suspicion of PNH.

The *natural history* of PNH can extend over decades. Without treatment, the median survival is ~8–10 years; in the past the commonest cause of death was venous thrombosis followed by infection secondary to severe

neutropenia and hemorrhage secondary to severe thrombocytopenia. PNH may evolve into aplastic anemia (AA), and PNH may manifest itself in patients who previously had AA. Rarely (estimated 1–2% of all cases), PNH may terminate in acute myeloid leukemia. However, full spontaneous recovery from PNH has been well documented, albeit rarely.

### Laboratory Investigations and Diagnosis

The most consistent blood finding is anemia, which may range from mild to moderate to very severe. The anemia is usually normo-macrocytic, with unremarkable red cell morphology; if the MCV is high, it is usually largely accounted for by reticulocytosis, which may be quite marked (up to 20%, or up to 400,000/ $\mu$ L). The anemia may become microcytic if the patient is allowed to become iron-deficient as a result of chronic urinary blood loss through hemoglobinuria. Neutropenia and/or thrombocytopenia may or may not be present from the outset or may develop subsequently. Unconjugated bilirubin is mildly or moderately elevated, LDH is typically markedly elevated (values in the thousands are common), and haptoglobin is usually undetectable. All these findings make the diagnosis of HA compelling. Hemoglobinuria may be overt in a random urine sample; if it is not, it may be helpful to obtain serial urine samples because hemoglobinuria can vary dramatically from day to day, and even from hour to hour (Fig. 10-8). The bone marrow is usually cellular with marked to massive erythroid hyperplasia, often with mild to moderate dyserythropoietic features (these do not justify confusing PNH with MDS). At some stage of the disease the marrow may become hypocellular or even frankly aplastic (see later).

The definitive diagnosis of PNH must be based on the demonstration that a substantial proportion of the patient's red cells have an increased susceptibility to complement (C), due to the deficiency on their surface of proteins (particularly CD59 and CD55) that normally protect the red cells from activated C. The sucrose hemolysis test is unreliable, and the acidified serum (Ham) test is carried out in few labs. The gold standard today is flow cytometry, which can be carried out on granulocytes as well as on red cells. A bimodal distribution of cells, with a discrete population that is CD59<sup>-</sup>, CD55<sup>-</sup>, is diagnostic of PNH. Usually this population is at least 5% of the total in the case of red cells and at least 20% of the total in the case of granulocytes.

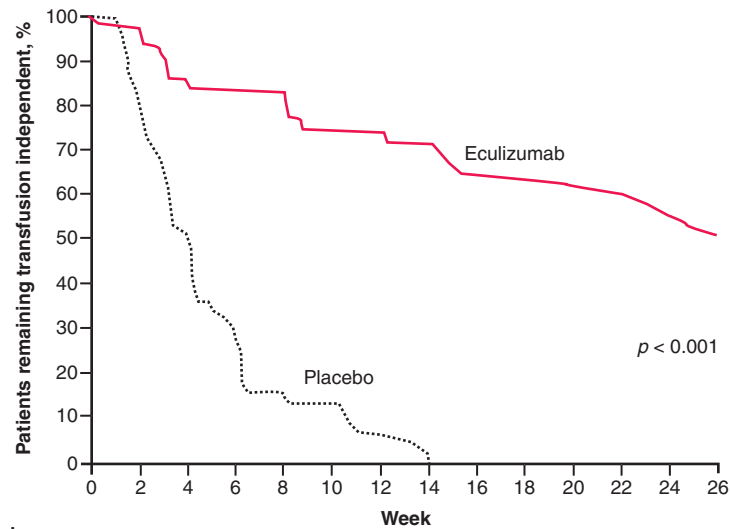
### Pathophysiology

Hemolysis in PNH is due to an intrinsic abnormality of the red cell, which makes it exquisitely sensitive to activated C, whether it is activated through the alternative pathway or through an antigen-antibody reaction.

The former mechanism is mainly responsible for intravascular hemolysis in PNH. The latter mechanism explains why the hemolysis can be dramatically exacerbated in the course of a viral or bacterial infection. Hypersusceptibility to C is due to deficiency of several protective membrane proteins, of which CD59 is the most important because it hinders the insertion of C9 polymers into the membrane. The molecular basis for the deficiency of these proteins has been pinpointed not to a defect in any of the respective genes but rather to the shortage of a unique glycolipid molecule, GPI, which, through a peptide bond, anchors these proteins to the surface membrane of cells. The shortage of GPI is due in turn to a mutation in an X-linked gene, called *PIG-A*, required for an early step in GPI biosynthesis. In virtually each patient, the *PIG-A* mutation is different. This is not surprising because these mutations are not inherited. Rather, each one takes place *de novo* in a hemopoietic stem cell (i.e., they are somatic mutations). As a result, the patient's marrow is a mosaic of mutant and nonmutant cells, and the peripheral blood always contains both PNH cells and normal (non-PNH) cells. Thrombosis is one of the most immediately life-threatening complications of PNH and yet one of the least understood in its pathogenesis. It could be that deficiency of CD59 on the PNH platelet causes inappropriate platelet activation; however, other mechanisms are possible.

### Bone Marrow Failure—Relationship between PNH and AA

It is not unusual that patients with firmly established PNH have a previous history of well-documented AA. However, sometimes a patient with PNH becomes less hemolytic and more pancytopenic and ultimately has the clinical picture of AA. Because AA is probably an organ-specific autoimmune disease in which T cells cause damage to hematopoietic stem cells, the same may be true of PNH, with the specific proviso that the damage spares PNH stem cells. Skewing of the T cell repertoire in patients with PNH supports this notion. In addition, in mouse models, PNH stem cells do not expand when the rest of the bone marrow is normal, and by high-sensitivity flow cytometry technology, very rare PNH cells harboring *PIG-A* mutations can be demonstrated in normal people. In view of these facts, it seems that an element of bone marrow failure (BMF) in PNH is the rule rather than the exception. An extreme view is that PNH is a form of AA in which BMF is masked by the massive expansion of the PNH clone that populates the patient's bone marrow. The mechanism whereby PNH stem cells escape the damage suffered by non-PNH stem cells is not yet known.



## No. at risk

Placebo group	44	44	36	30	23	13	7	6	3	1	0	0	0	0
Eculizumab group	43	41	41	39	37	36	36	32	32	31	27	27	26	26

**FIGURE 10-9**

**Therapeutic efficacy of an anti-C5 antibody on the anemia of paroxysmal nocturnal hemoglobinuria.** (From P Hillmen et al: *N Engl J Med* 355:1233, 2006; with permission.)

### Rx Treatment: PAROXYSMAL NOCTURNAL HEMOGLOBINURIA

Unlike other acquired HAs, PNH may be lifelong and most patients receive supportive treatment only, including transfusion of filtered red cells<sup>2</sup> whenever necessary. Folic acid supplements (at least 3 mg/d) are mandatory; the serum iron should be checked periodically and iron supplements administered as appropriate. Long-term glucocorticoids are not indicated because there is no evidence that they have any effect on chronic hemolysis, and their side effects are considerable and potentially dangerous. The only form of treatment that can provide a cure for PNH is allogeneic bone marrow transplantation (BMT); when an HLA-identical sibling is available, BMT should be offered to any young patient with severe PNH.

A major advance in the management of PNH has been the development of a humanized monoclonal antibody, eculizumab, directed against the complement protein C5 (Fig. 10-9). By blocking the complement cascade downstream of C5, this antibody provides a

medical intervention capable of controlling complement-dependent hemolysis in PNH. In an international multicenter placebo-controlled randomized trial on 87 patients who had been selected on grounds of having severe transfusion-dependent hemolysis, eculizumab completely abolished the need for blood transfusion in about half of the patients. Eculizumab administered intravenously at every 2-week intervals also ameliorated the anemia in most patients and dramatically improved their quality of life.

For patients with PNH-AA syndrome, immunosuppressive treatment with antilymphocyte globulin (ALG or ATG) and cyclosporine A may be indicated. Although no formal trial has ever been conducted, this approach has helped particularly to relieve severe thrombocytopenia and/or neutropenia in patients in whom these were the main problem(s). By contrast, there is often little immediate effect on hemolysis. Thrombolytic therapy with tissue plasminogen activator may be indicated after severe thrombosis. Any patient who has had deep vein thrombosis at any site in the abdomen or in a limb should be on regular anticoagulant prophylaxis.

### ANEMIA DUE TO ACUTE BLOOD LOSS

Blood loss causes anemia by two main mechanisms: first, by the direct loss of red cells; second, because if the loss of blood is protracted, it will gradually deplete the iron

<sup>2</sup>Now that filters with excellent removal of white cells are routinely used, the traditional washing of red cells, which aimed to avoid white cell reactions triggering hemolysis, is no longer necessary and considered wasteful.

stores, eventually resulting in iron deficiency. Iron-deficiency anemia is discussed in Chap. 7.

Here we are concerned with *posthemorrhagic anemia*, which follows *acute blood loss*. This can be *external* (as after trauma or due to postpartum hemorrhage) or *internal* (e.g., from bleeding in the gastrointestinal tract, rupture of the spleen, rupture of an ectopic pregnancy). In any of these cases—i.e., after the sudden loss of a large amount of blood—three clinical/pathophysiologic stages are noted.

1. At first, the dominant feature is hypovolemia, which poses a threat particularly to organs that normally have a high blood supply, such as the brain and the kidneys; therefore, loss of consciousness and acute renal failure are major threats. It is important to note that at this stage an ordinary blood count will not show anemia because the hemoglobin concentration is not affected.
2. Next, as an emergency response, baroreceptors and stretch receptors will cause release of vasopressin and other peptides, and the body will shift fluid from the extravascular to the intravascular compartment, producing hemodilution. Thus the hypovolemia gradually converts to anemia. The degree of anemia will reflect the amount of blood lost. If after 3 days the hemoglobin is, say, 7 g/dL, it means that about half of the entire blood volume has been lost.
3. Provided bleeding does not continue, the bone marrow response will gradually ameliorate the anemia if erythropoietin production, the erythroid progenitors, and iron supply are normal. Within about 2–3 days after acute hemorrhage, reticulocytes will increase in the blood and reach a maximum 7–10 days after the hemorrhage has been controlled. Reticulocyte counts of 20% may be achieved.

The diagnosis of acute posthemorrhagic anemia (APHA) is usually straightforward, although sometimes internal bleeding episodes—after a traumatic injury or otherwise—may not be immediately obvious, even when large. Whenever an abrupt fall in hemoglobin has taken place, whatever history is given by the patient, APHA should be suspected. Supplementary history may have to be obtained by asking the appropriate questions, and appropriate investigations (e.g., a sonogram or an endoscopy) may have to be carried out. Internal bleeding may result in a rise in unconjugated bilirubin and a fall in serum haptoglobin.

## **R<sub>x</sub>** Treatment: ANEMIA DUE TO BLOOD LOSS

With respect to treatment, a two-pronged approach is imperative. First, in many cases the blood lost needs to be replaced promptly. With many chronic anemias, finding and correcting the cause of the anemia is the first priority, and blood transfusion may not be even necessary because the body is adapted to the anemia; with acute blood loss the reverse is true. Because the body is not adapted to the anemia, blood transfusion takes priority. Although fluorocarbon synthetic chemicals have shown promise, no “blood substitute” has yet become standard treatment. Second, while the emergency is being confronted, it is imperative to stop the hemorrhage and to eliminate its source.

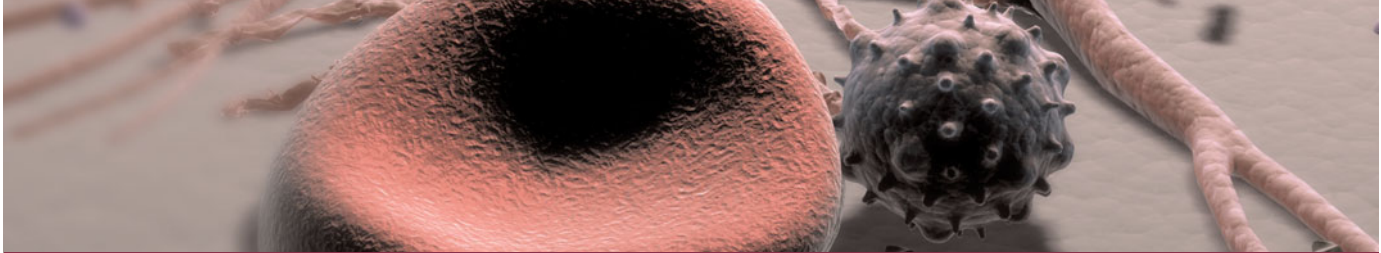
### ACKNOWLEDGMENT

*H. Frank Bunn and Wendell Rosse contributed this chapter in the 16th edition of Harrison's Principles of Internal Medicine and material from that chapter has been used here.*

### FURTHER READINGS

- DACIE J: *The Haemolytic Anaemias*, 5 volumes. London, Churchill Livingstone, 1995
- EBER S, LUX SE: Hereditary spherocytosis—defects in proteins that connect the membrane skeleton to the lipid bilayer. *Semin Hematol* 41:118, 2004
- HEIER HE et al: Transfusion versus alternative treatment modalities in acute bleeding: A systematic review. *Acta Anaesthesiol Scand* 50:20, 2006
- HILL A et al: Recent developments in the understanding and management of paroxysmal nocturnal hemoglobinuria. *Br J Haematol* 137:181, 2007
- HILLMEN P et al: The complement inhibitor eculizumab in paroxysmal nocturnal hemoglobinuria. *N Engl J Med* 355:1233, 2006
- LUZZATTO L: Paroxysmal nocturnal hemoglobinuria, in *Clinical Hematology*, N Young, Gershon SL, High KA (eds). Philadelphia, Mosby, pp 326–339, 2006
- PARKER CJ: Bone marrow failure syndromes: Paroxysmal nocturnal hemoglobinuria. *Hematol Oncol Clin North Am* 23:333, 2009
- ROSSE WF et al: Immune-mediated hemolytic anemia. *Hematology Am Soc Hematol Educ Program* pp. 48–62, 2004
- SALAMA A: Drug-induced immune hemolytic anemia. *Expert Opin Drug Saf* 8:73, 2009
- SHAPIRA Y et al: Erythropoietin can obviate the need for repeated heart valve replacement in high-risk patients with severe mechanical hemolytic anemia: Case reports and literature review. *J Heart Valve Dis* 10:431, 2001
- SHAPIRA Y et al: Hemolysis associated with prosthetic heart valves: A review. *Cardiol Rev* 17:121, 2009





## CHAPTER 11

# APLASTIC ANEMIA, MYELOYDYSPLASIA, AND RELATED BONE MARROW FAILURE SYNDROMES

Neal S. Young

■ Aplastic Anemia . . . . .	128	Clinical Associations and Etiology . . . . .	137
Definition . . . . .	128	■ Myelodysplasia . . . . .	138
Epidemiology . . . . .	129	Definition . . . . .	138
Pathophysiology . . . . .	131	Epidemiology . . . . .	139
Clinical Features . . . . .	133	Etiology and Pathophysiology . . . . .	139
Laboratory Studies . . . . .	133	Clinical Features . . . . .	140
Diagnosis . . . . .	134	Laboratory Studies . . . . .	140
Prognosis . . . . .	134	Differential Diagnosis . . . . .	140
■ Pure Red Cell Aplasia . . . . .	136	Prognosis . . . . .	140
Definition and Differential Diagnosis . . . . .	136	■ Myelophthitic Anemias . . . . .	142
		■ Further Readings . . . . .	142

The hypoproliferative anemias are normochromic, normocytic, or macrocytic and are characterized by a low reticulocyte count. Deficient production of RBCs occurs with marrow damage and dysfunction, which may be secondary to infection, inflammation, and cancer. Hypoproliferative anemia is also a prominent feature of hematologic diseases that are described as bone marrow failure states; these include aplastic anemia, myelodysplasia (MDS), pure red cell aplasia (PRCA), and myelophthisis. Anemia in these disorders is often not a solitary or even the major hematologic finding. More frequent in bone marrow failure is pancytopenia: anemia, leukopenia, and thrombocytopenia. Low blood counts in the marrow failure diseases result from deficient hematopoiesis, as distinguished from blood count depression due to peripheral destruction of red cells (hemolytic anemias), platelets (idiopathic thrombocytopenic purpura or due to splenomegaly), and granulocytes (as in the immune leukopenias).

Hematopoietic failure syndromes are classified by dominant morphologic features of the bone marrow (Table 11-1). Although practical distinction among

these syndromes usually is clear, they can occur secondary to other diseases, and some processes are so closely related that the diagnosis may be complex. Patients may seem to suffer from two or three related diseases simultaneously, or one diagnosis may appear to evolve into another. Many of these syndromes share an immune-mediated mechanism of marrow destruction and some element of genomic instability resulting in a higher rate of malignant transformation.

### APLASTIC ANEMIA

#### DEFINITION

Aplastic anemia is pancytopenia with bone marrow hypocellularity. Acquired aplastic anemia is distinguished from iatrogenic marrow aplasia, marrow hypocellularity after intensive cytotoxic chemotherapy for cancer. Aplastic anemia can also be constitutional: the genetic diseases Fanconi's anemia and dyskeratosis congenita, although frequently associated with typical physical anomalies and the development of pancytopenia early in life, can also

TABLE 11-1

DIFFERENTIAL DIAGNOSIS OF PANCYTOPENIA	
<b>Pancytopenia with Hypocellular Bone Marrow</b>	
Acquired aplastic anemia	
Constitutional aplastic anemia (Fanconi's anemia, dyskeratosis congenita)	
Some myelodysplasia	
Rare aleukemic leukemia (AML)	
Some acute lymphoid leukemia	
Some lymphomas of bone marrow	
<b>Pancytopenia with Cellular Bone Marrow</b>	
Primary bone marrow diseases	Secondary to systemic diseases
Myelodysplasia	Systemic lupus erythematosus
Paroxysmal nocturnal hemoglobinuria	Hypersplenism
Myelofibrosis	B <sub>12</sub> , folate deficiency
Some aleukemic leukemia	Overwhelming infection
Myelophthisis	Alcohol
Bone marrow lymphoma	Brucellosis
Hairy cell leukemia	Sarcoidosis
	Tuberculosis
	Leishmaniasis
<b>Hypocellular Bone Marrow ± Cytopenia</b>	
Q fever	
Legionnaires' disease	
Anorexia nervosa, starvation	
<i>Mycobacteria</i>	

present as marrow failure in normal-appearing adults. Acquired aplastic anemia is often stereotypical in its manifestations, with the abrupt onset of low blood counts in a previously well young adult; seronegative hepatitis or a course of an incriminated medical drug may precede the onset. The diagnosis in these instances is uncomplicated. Sometimes blood count depression is moderate or incomplete, resulting in anemia, leukopenia, and thrombocytopenia in some combination. Aplastic anemia is related to both paroxysmal nocturnal hemoglobinuria (PNH; Chap. 10) and to MDS, and in some cases a clear distinction among these disorders may not be possible.

## EPIDEMIOLOGY



The incidence of acquired aplastic anemia in Europe and Israel is two cases per million persons annually. In Thailand and China, rates of five to seven per million have been established. In general, men and women are affected with equal frequency, but the age distribution is biphasic, with the major peak in the teens and twenties and a second rise in the elderly.

## ETIOLOGY

The origins of aplastic anemia have been inferred from several recurring clinical associations (Table 11-2); unfortunately, these relationships are not reliable in an individual patient and may not be etiologic. In addition, although most cases of aplastic anemia are idiopathic, little other than history separates these cases from those with a presumed etiology such as a drug exposure.

TABLE 11-2

CLASSIFICATION OF APLASTIC ANEMIA AND SINGLE CYTOPENIAS	
ACQUIRED	INHERITED
<b>Aplastic Anemia</b>	
Secondary	Fanconi's anemia
Radiation	Dyskeratosis congenita
Drugs and chemicals	Shwachman-Diamond syndrome
Regular effects	Reticular dysgenesis
Idiosyncratic reactions	Amegakaryocytic thrombocytopenia
Viruses	Familial aplastic anemias
Epstein-Barr virus (infectious mononucleosis)	Preleukemia (monosomy 7, etc.)
Hepatitis (non-A, non-B, non-C hepatitis)	Nonhematologic syndrome (Down's, Dubowitz, Seckel)
Parvovirus B19 (transient aplastic crisis, PRCA)	
HIV-1 (AIDS)	
Immune diseases	
Eosinophilic fasciitis	
Hypoimmunoglobulinemia	
Thymoma/thymic carcinoma	
Graft-versus-host disease in immunodeficiency	
Paroxysmal nocturnal hemoglobinuria	
Pregnancy	
Idiopathic	
<b>Cytopenias</b>	
PRCA (see Table 11-4)	Congenital PRCA (Diamond-Blackfan anemia)
Neutropenia/Agranulocytosis	
Idiopathic	Kostmann's syndrome
Drugs, toxins	Shwachman-Diamond syndrome
Pure white cell aplasia	Reticular dysgenesis
Thrombocytopenia	
Drugs, toxins	Amegakaryocytic thrombocytopenia
Idiopathic	Thrombocytopenia with absent radii
amegakaryocytic	

**Note:** PRCA, pure red cell aplasia

Marrow aplasia is a major acute sequela of radiation. Radiation damages DNA; tissues dependent on active mitosis are particularly susceptible. Nuclear accidents can involve not only power plant workers but also employees of hospitals, laboratories, and industry (food sterilization, metal radiography, etc.), as well as innocents exposed to stolen, misplaced, or misused sources. Although the radiation dose can be approximated from the rate and degree of decline in blood counts, dosimetry by reconstruction of the exposure can help to estimate the patient's prognosis and also protect medical personnel from contact with radioactive tissue and excreta. MDS and leukemia, but probably not aplastic anemia, are late effects of radiation.

### Chemicals

Benzene is a notorious cause of bone marrow failure. Vast quantities of epidemiologic, clinical, and laboratory data link benzene to aplastic anemia, acute leukemia, and blood and marrow abnormalities. The occurrence of leukemia is roughly correlated with cumulative exposure, but susceptibility must also be important because only a minority of even heavily exposed workers develop benzene myelotoxicity. The employment history is important, especially in industries where benzene is used for a secondary purpose, usually as a solvent. Benzene-related blood diseases have declined with regulation of industrial exposure. Although benzene is no longer generally available as a household solvent, exposure to its metabolites occurs in the normal diet and in the environment. The association between marrow failure and other chemicals is much less well substantiated.

### Drugs

(Table 11-3) Many chemotherapeutic drugs have marrow suppression as a major toxicity; effects are dose-dependent and occur in all recipients. In contrast, idiosyncratic reactions to a large and diverse group of drugs may lead to aplastic anemia without a clear dose-response relationship. These associations rested largely on accumulated case reports until a large international study in Europe in the 1980s quantitated drug relationships, especially for nonsteroidal analgesics, sulfonamides, thyrostatic drugs, some psychotropics, penicillamine, allopurinol, and gold. Not all associations necessarily reflect causation: a drug may have been used to treat the first symptoms of bone marrow failure (antibiotics for fever or the preceding viral illness) or provoked the first symptom of a preexisting disease (petechiae by nonsteroidal anti-inflammatory agents administered to the thrombocytopenic patient). In the context of total drug use, idiosyncratic reactions, although individually devastating, are rare events. Chloramphenicol, the most infamous culprit, reportedly

**TABLE 11-3**

### SOME DRUGS AND CHEMICALS ASSOCIATED WITH APLASTIC ANEMIA

Agents that regularly produce marrow depression as major toxicity in commonly employed doses or normal exposures:
Cytotoxic drugs used in cancer chemotherapy: <i>alkylating agents, antimetabolites, antimitotics, some antibiotics</i>
Agents that frequently but not inevitably produce marrow aplasia:
<i>Benzene</i>
Agents associated with aplastic anemia but with a relatively low probability:
<i>Chloramphenicol</i>
Insecticides
Antiprotozoals: <i>quinacrine</i> and chloroquine, mepacrine
Nonsteroidal anti-inflammatory drugs (including <i>phenylbutazone</i> , indomethacin, ibuprofen, sulindac, aspirin)
Anticonvulsants ( <i>hydantoins, carbamazepine, phenacemide, felbamate</i> )
Heavy metals ( <i>gold, arsenic, bismuth, mercury</i> )
Sulfonamides: some antibiotics, antithyroid drugs (methimazole, methylthiouracil, propylthiouracil), antidiabetes drugs (tolbutamide, chlorpropamide), carbonic anhydrase inhibitors (acetazolamide and methazolamide)
Antihistamines ( <i>cimetidine, chlorpheniramine</i> )
D-Penicillamine
Estrogens (in pregnancy and in high doses in animals)
Agents whose association with aplastic anemia is more tenuous:
Other antibiotics (streptomycin, tetracycline, methicillin, mebendazole, trimethoprim/sulfamethoxazole, flucytosine)
Sedatives and tranquilizers (chlorpromazine, prochlorperazine, piperacetazine, chlordiazepoxide, meprobamate, methyprylon)
Allopurinol
Methyldopa
Quinidine
Lithium
Guanidine
Potassium perchlorate
Thiocyanate
Carbimazole

**Note:** Terms set in italics show the most consistent association with aplastic anemia.

produced aplasia in only ~1/60,000 therapy courses, and even this number is almost certainly an overestimate (risks are almost invariably exaggerated when based on collections of cases; although the introduction of chloramphenicol was perceived to have created an epidemic of aplastic anemia, its diminished use was not followed by a changed frequency of marrow failure). Risk estimates are usually lower when determined in population-based

studies; furthermore, the low absolute risk is also made more obvious: even a 10- or 20-fold increase in risk translates, in a rare disease, to but a handful of drug-induced aplastic anemia cases among hundreds of thousands of exposed persons.

### Infections

Hepatitis is the most common preceding infection, and posthepatitis marrow failure accounts for ~5% of etiologies in most series. Patients are usually young men who have recovered from a bout of liver inflammation 1 to 2 months earlier; the subsequent pancytopenia is very severe. The hepatitis is seronegative (non-A, non-B, non-C, non-G) and possibly due to a novel, as yet undiscovered, virus. Fulminant liver failure in childhood also follows seronegative hepatitis, and marrow failure occurs at a high rate in these patients. Aplastic anemia can rarely follow infectious mononucleosis, and Epstein-Barr virus has been found in the marrow of a few patients, some without a suggestive preceding history. Parvovirus B19, the cause of transient aplastic crisis in hemolytic anemias and of some PRCAs (see later), does not usually cause generalized bone marrow failure. Mild blood count depression is frequent in the course of many viral and bacterial infections but resolves with the infection.

### Immunologic Diseases

Aplasia is a major consequence and the inevitable cause of death in *transfusion-associated graft-versus-host disease* (GVHD), which can occur after infusion of unirradiated blood products to an immunodeficient recipient. Aplastic anemia is strongly associated with the rare collagen vascular syndrome called *eosinophilic fasciitis*, which is characterized by painful induration of subcutaneous tissues. Pancytopenia with marrow hypoplasia can also occur in systemic lupus erythematosus.

### Pregnancy

Aplastic anemia very rarely may occur and recur during pregnancy and resolve with delivery or with spontaneous or induced abortion.

### Paroxysmal Nocturnal Hemoglobinuria

An acquired mutation in the *PIG-A* gene in a hematopoietic stem cell is required for the development of PNH, but *PIG-A* mutations probably occur commonly in normal individuals. If the *PIG-A* mutant stem cell proliferates, the result is a clone of progeny deficient in glycosylphosphatidylinositol-linked cell surface membrane proteins (Chap. 10). Such PNH cells are now accurately enumerated using fluorescence-activated flow cytometry of CD55 or CD59 expression on granulocytes

rather than Ham or sucrose lysis tests on red cells. Small clones of deficient cells can be detected in about half of patients with aplastic anemia at the time of presentation [and PNH cells are also seen in MDS (see later)]; frank hemolysis and thrombotic episodes occur in patients with large PNH clones (>50%). Functional studies of bone marrow from PNH patients, even those with mainly hemolytic manifestations, show evidence of defective hematopoiesis. Patients with an initial clinical diagnosis of PNH, especially younger individuals, may later develop frank marrow aplasia and pancytopenia; patients with an initial diagnosis of aplastic anemia may suffer from hemolytic PNH years after recovery of blood counts. One popular but unproven explanation for the aplastic anemia/PNH syndrome is selection of the deficient clones because they are favored for proliferation in the peculiar environment of immune-mediated marrow destruction.

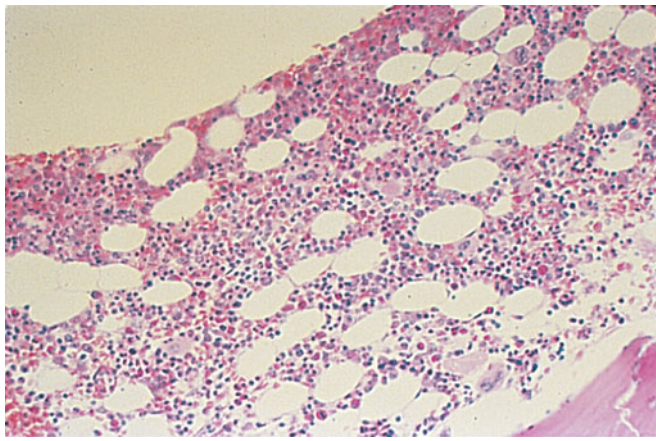
### Constitutional Disorders

Fanconi's anemia, an autosomal recessive disorder, manifests as congenital developmental anomalies, progressive pancytopenia, and an increased risk of malignancy. Chromosomes in Fanconi's anemia are peculiarly susceptible to DNA cross-linking agents, the basis for a diagnostic assay. Patients with Fanconi's anemia typically have short stature, café au lait spots, and anomalies involving the thumb, radius, and genitourinary tract. At least 12 different genetic defects (all but one with an identified gene) have been defined; the most common, type A Fanconi's anemia, is due to a mutation in *FANCA*. Most of the Fanconi's anemia gene products form a protein complex that activates FANCD2 by monoubiquitination to play a role in the cellular response to DNA damage and especially interstrand cross-linking, a response that includes BRCA1, ATM, and NBS1.

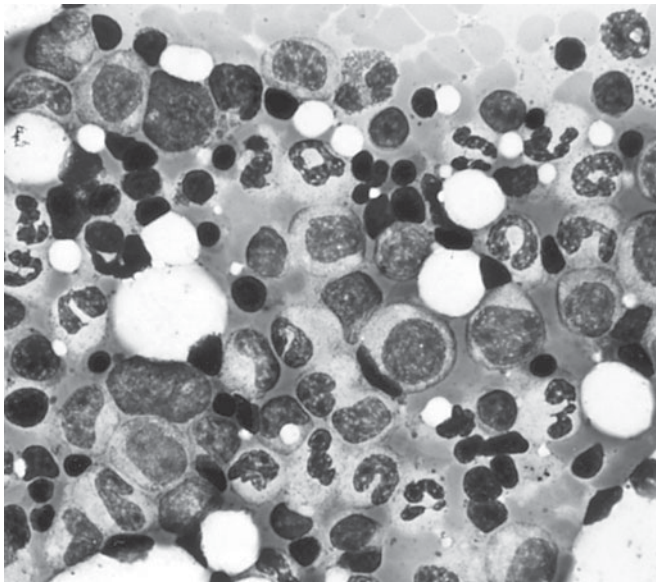
Dyskeratosis congenita is characterized by mucous membrane leukoplakia, dystrophic nails, reticular hyperpigmentation, and the development of aplastic anemia during childhood. The X-linked variety is due to mutations in the *DKC1* (*dyskerin*) gene; the more unusual autosomal dominant type is due to mutation in *hTERC*, which encodes an RNA template, and *hTERT*, which encodes the catalytic reverse transcriptase, telomerase; these gene products cooperate in a repair complex to maintain telomere length. In Shwachman-Diamond syndrome, marrow failure is seen with pancreatic insufficiency and malabsorption; most patients have compound heterozygous mutations in *SBDS*, which has been implicated in RNA processing.

### PATHOPHYSIOLOGY

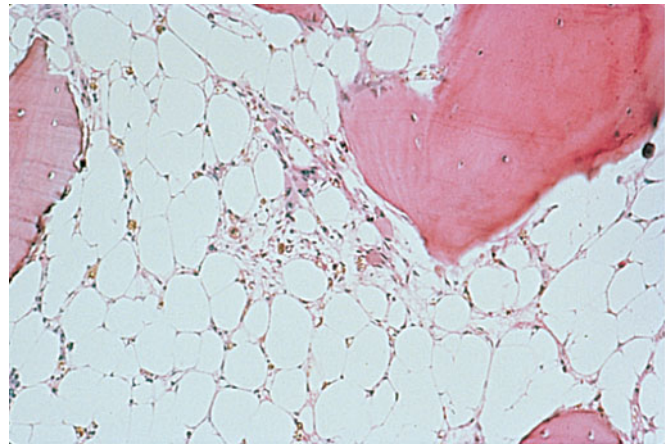
Bone marrow failure results from severe damage to the hematopoietic cell compartment. In aplastic anemia, replacement of the bone marrow by fat is apparent in



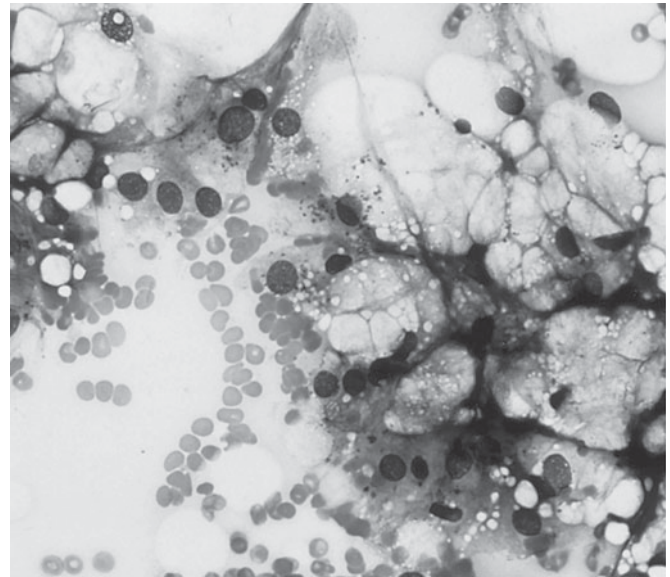
A



B



C



D

**FIGURE 11-1**

**A.** Normal bone marrow biopsy. **B.** Normal bone marrow aspirate smear. The marrow is normally 30–70% cellular, and there is a heterogeneous mix of myeloid, erythroid, and lymphoid cells. **C.** Aplastic anemia biopsy. **D.** Marrow smear

in aplastic anemia. The marrow shows replacement of hematopoietic tissue by fat and only residual stromal and lymphoid cells.

the morphology of the biopsy specimen (Fig. 11-1) and MRI of the spine. Cells bearing the CD34 antigen, a marker of early hematopoietic cells, are greatly diminished, and in functional studies, committed and primitive progenitor cells are virtually absent; in vitro assays have suggested that the stem cell pool is reduced to  $\leq 1\%$  of normal in severe disease at the time of presentation.

An intrinsic stem cell defect exists for the constitutional aplastic anemias: cells from patients with Fanconi's anemia exhibit chromosome damage and death on exposure to certain chemical agents. Telomeres are short in a large proportion of patients with aplastic anemia, and mutations in genes of the telomere repair complex (*TERC* and *TERT*) can be identified in some adults

with apparently acquired marrow failure and without physical anomalies or typical family history.

Aplastic anemia does not appear to result from defective stroma or growth factor production.

### Drug Injury

Extrinsic damage to the marrow follows massive physical or chemical insults such as high doses of radiation and toxic chemicals. For the more common idiosyncratic reaction to modest doses of medical drugs, altered drug metabolism has been invoked as a likely mechanism. The metabolic pathways of many drugs and chemicals, especially if they are polar and have limited water solubility,

involve enzymatic degradation to highly reactive electrophilic compounds; these intermediates are toxic because of their propensity to bind to cellular macromolecules. For example, derivative hydroquinones and quinolones are responsible for benzene-induced tissue injury. Excessive generation of toxic intermediates or failure to detoxify the intermediates may be genetically determined and apparent only on specific drug challenge; the complexity and specificity of the pathways imply multiple susceptibility loci and would provide an explanation for the rarity of idiosyncratic drug reactions.

### **Immune-Mediated Injury**

The recovery of marrow function in some patients prepared for bone marrow transplantation with antilymphocyte globulin (ALG) first suggested that aplastic anemia might be immune-mediated. Consistent with this hypothesis was the frequent failure of simple bone marrow transplantation from a syngeneic twin, without conditioning cytotoxic chemotherapy, which also argued both *against* simple stem cell absence as the cause and *for* the presence of a host factor producing marrow failure. Laboratory data support an important role for the immune system in aplastic anemia. Blood and bone marrow cells of patients can suppress normal hematopoietic progenitor cell growth, and removal of T cells from aplastic anemia bone marrow improves colony formation *in vitro*. Increased numbers of activated cytotoxic T cells are observed in aplastic anemia patients and usually decline with successful immunosuppressive therapy; cytokine measurements show a  $T_H1$  immune response (interferon  $\gamma$  and tumor necrosis factor). Interferon and tumor necrosis factor induce Fas expression on CD34 cells, leading to apoptotic cell death; localization of activated T cells to bone marrow and local production of their soluble factors are probably important in stem cell destruction.

Early immune system events in aplastic anemia are not well understood. Analysis of T cell receptor expression suggests an oligoclonal, antigen-driven cytotoxic T cell response. Many different exogenous antigens appear capable of initiating a pathologic immune response, but at least some of the T cells may recognize true self-antigens. The rarity of aplastic anemia despite common exposures (medicines, hepatitis virus) suggests that genetically determined features of the immune response can convert a normal physiologic response into a sustained abnormal autoimmune process, including polymorphisms in histocompatibility antigens, cytokine genes, and genes that regulate T cell polarization and effector function.

## **CLINICAL FEATURES**

### **History**

Aplastic anemia can appear with seeming abruptness or have a more insidious onset. Bleeding is the most

common early symptom; a complaint of days to weeks of easy bruising, oozing from the gums, nosebleeds, heavy menstrual flow, and sometimes petechiae will have been noticed. With thrombocytopenia, massive hemorrhage is unusual, but small amounts of bleeding in the central nervous system can result in catastrophic intracranial or retinal hemorrhage. Symptoms of anemia are also frequent, including lassitude, weakness, shortness of breath, and a pounding sensation in the ears. Infection is an unusual first symptom in aplastic anemia (unlike in agranulocytosis, where pharyngitis, anorectal infection, or frank sepsis occur early). A striking feature of aplastic anemia is the restriction of symptoms to the hematologic system, and patients often feel and look remarkably well despite drastically reduced blood counts. Systemic complaints and weight loss should point to other etiologies of pancytopenia. Prior drug use, chemical exposure, and preceding viral illnesses must often be elicited with repeated questioning. A family history of hematologic diseases or blood abnormalities may indicate a constitutional etiology of marrow failure.

### **Physical Examination**

Petechiae and ecchymoses are typical, and retinal hemorrhages may be present. Pelvic and rectal examinations can often be deferred but, when performed, should be undertaken with great gentleness to avoid trauma; these will often show bleeding from the cervical os and blood in the stool. Pallor of the skin and mucous membranes is common except in the most acute cases or those already transfused. Infection on presentation is unusual but may occur if the patient has been symptomatic for a few weeks. Lymphadenopathy and splenomegaly are highly atypical of aplastic anemia. Café au lait spots and short stature suggest Fanconi's anemia; peculiar nails and leukoplakia suggest dyskeratosis congenita.

## **LABORATORY STUDIES**

### **Blood**

The smear shows large erythrocytes and a paucity of platelets and granulocytes. Mean corpuscular volume (MCV) is commonly increased. Reticulocytes are absent or few, and lymphocyte numbers may be normal or reduced. The presence of immature myeloid forms suggests leukemia or MDS; nucleated red blood cells suggest marrow fibrosis or tumor invasion; abnormal platelets suggest either peripheral destruction or MDS.

### **Bone Marrow**

The bone marrow is usually readily aspirated but dilute on smear, and the fatty biopsy specimen may be grossly pale on withdrawal; a "dry tap" instead suggests fibrosis or myelophthisis. In severe aplasia the smear of the

134 aspirated specimen shows only red cells, residual lymphocytes, and stromal cells; the biopsy (which should be >1 cm in length) is superior for determination of cellularity and shows mainly fat under the microscope, with hematopoietic cells occupying <25% of the marrow space; in the most serious cases the biopsy is virtually 100% fat. The correlation between marrow cellularity and disease severity is imperfect, in part because marrow cellularity declines physiologically with aging. Additionally, some patients with moderate disease by blood counts have empty iliac crest biopsies, and “hot spots” of hematopoiesis may be seen in severe cases. If an iliac crest specimen is inadequate, cells may also be obtained by aspiration from the sternum. Residual hematopoietic cells should have normal morphology, except for mildly megaloblastic erythropoiesis; megakaryocytes are invariably greatly reduced and usually absent. Areas adjacent to the spicule should be searched for myeloblasts. Granulomas (in cellular specimens) may indicate an infectious etiology of the marrow failure.

### Ancillary Studies

Chromosome breakage studies of peripheral blood using diepoxybutane or mitomycin C should be performed on children and younger adults to exclude Fanconi’s anemia. Genetic analysis applicable to the constitutional marrow failure states is available in some laboratories. Chromosome studies of bone marrow cells are often revealing in MDS and should be negative in typical aplastic anemia. Flow cytometric assays have replaced the Ham test for the diagnosis of PNH. Serologic studies may show evidence of viral infection, such as Epstein-Barr virus and HIV. Posthepatitis aplastic anemia is typically seronegative. The spleen size should be determined by CT scanning or ultrasound if the physical examination of the abdomen is unsatisfactory. MRI may be helpful to assess the fat content of a few vertebrae in order to distinguish aplasia from MDS.

### DIAGNOSIS

The diagnosis of aplastic anemia is usually straightforward, based on the combination of pancytopenia with a fatty, empty bone marrow. Aplastic anemia is a disease of the young and should be a leading diagnosis in the pancytopenic adolescent or young adult. When pancytopenia is secondary, the primary diagnosis is usually obvious from either history or physical examination: the massive spleen of alcoholic cirrhosis, the history of metastatic cancer or systemic lupus erythematosus, or miliary tuberculosis on chest radiograph (Table 11-1).

Diagnostic problems can occur with atypical presentations and among related hematologic diseases. Although pancytopenia is most common, some patients with bone marrow hypocellularity have depression of only one or

two of three blood lines, sometimes showing later progression to more recognizable aplastic anemia. The bone marrow in constitutional aplastic anemia is indistinguishable morphologically from the aspirate in acquired disease. The diagnosis can be suggested by family history, abnormal blood counts since childhood, or the presence of associated physical anomalies. Aplastic anemia may be difficult to distinguish from the hypocellular variety of MDS: MDS is favored by finding morphologic abnormalities, particularly of megakaryocytes and myeloid precursor cells, and typical cytogenetic abnormalities (see later).

### PROGNOSIS

The natural history of severe aplastic anemia is rapid deterioration and death. Provision first of red blood cell and later of platelet transfusions and effective antibiotics are of some benefit, but few patients show spontaneous recovery. The major prognostic determinant is the blood count; severe disease is defined by the presence of two of three parameters: absolute neutrophil count <500/ $\mu\text{L}$ , platelet count <20,000/ $\mu\text{L}$ , and corrected reticulocyte count <1% (or absolute reticulocyte count <60,000/ $\mu\text{L}$ ). Survival of patients who fulfill these criteria is ~20% at 1 year after diagnosis with only supportive care; patients with very severe disease, defined by an absolute neutrophil count <200/ $\mu\text{L}$ , fare even more poorly. Treatment has markedly improved survival in this disease.

#### **R<sub>x</sub> Treatment:** **APLASTIC ANEMIA**

Severe acquired aplastic anemia can be cured by replacement of the absent hematopoietic cells (and the immune system) by stem cell transplant, or it can be ameliorated by suppression of the immune system to allow recovery of the patient’s residual bone marrow function. Hematopoietic growth factors have limited usefulness and glucocorticoids are of no value. Suspect exposures to drugs or chemicals should be discontinued; however, spontaneous recovery of severe blood count depression is rare, and a waiting period before beginning treatment may not be advisable unless the blood counts are only modestly depressed.

**HEMATOPOIETIC STEM CELL TRANSPLANTATION** This is the best therapy for the young patient with a fully histocompatible sibling donor (Chap. 29). Human leukocyte antigen (HLA) typing should be ordered as soon as the diagnosis of aplastic anemia is established in a child or younger adult. In transplant candidates, transfusion of blood from family members should be avoided so as to prevent sensitization to histocompatibility antigens; although transfusions in general should be minimized, limited numbers

of blood products probably do not seriously affect outcome.

For allogeneic transplant from fully matched siblings, long-term survival rates for children are 80–90%. Transplant morbidity and mortality are increased among adults, due mainly to the higher risk of chronic GVHD and serious infections. Graft rejection was historically a major determinant of outcome in transplant for aplastic anemia, perhaps related to the underlying pathophysiology as well as to alloimmunization from transfusions (the latter now much improved by leukocyte depletion before blood product administration).

Most patients do not have a suitable sibling donor. Occasionally, a full phenotypic match can be found within the family and serve as well. Far more available are other alternative donors, either unrelated but histocompatible volunteers or closely but not perfectly matched family members. Survival using alternative donors is about half that of conventional sibling transplants but improving with higher-resolution HLA matching and more effective conditioning regimens and GVHD prophylaxis. Patients are at risk for late complications, especially a higher rate of cancer, if radiation is used as a component of conditioning.

**IMMUNOSUPPRESSION** Used alone, ALG or antithymocyte globulin (ATG) induces hematologic recovery (independence from transfusion and a leukocyte count adequate to prevent infection) in ~50% of patients. The addition of cyclosporine to either ALG or ATG has further increased response rates to ~70% and especially improved outcomes for children and for severely neutropenic patients. Such combined treatment is now standard for patients with severe disease. An early robust hematologic response strongly correlates with long-term survival. Improvement in granulocyte number is generally apparent within 2 months of treatment. Most recovered patients continue to have some degree of blood count depression, the MCV remains elevated, and the bone marrow cellularity returns toward normal only very slowly, if at all. Relapse (recurrent pancytopenia) is frequent, often occurring as cyclosporine is discontinued; most, but not all, patients respond to reinstatement of immunosuppression, but some responders become dependent on continued cyclosporine administration. Development of MDS, with typical marrow morphologic or cytogenetic abnormalities, occurs in ~15% of treated patients, usually but not invariably associated with a return of pancytopenia, and some patients develop leukemia. A laboratory diagnosis of PNH can generally be made at the time of presentation of aplastic anemia by flow cytometry; recovered patients may have frank hemolysis if the PNH clone expands. Bone marrow examinations should be performed if there is an unfavorable change in blood counts.

Horse ATG is given at 40 mg/kg per day for 4 days; rabbit ALG is administered at 3.5 mg/kg per day for 5 days. For ATG, anaphylaxis is a rare but occasionally fatal complication; allergy can be tested by a skin-prick test with an undiluted solution and immediate observation; desensitization is feasible. ATG binds to peripheral blood cells; therefore, platelet and granulocyte numbers may fall further during active treatment. Serum sickness, a flu-like illness with a characteristic cutaneous eruption and arthralgia, often develops ~10 days after initiating treatment. Methylprednisolone, 1 mg/kg per day for 2 weeks, can ameliorate the immune consequences of heterologous protein infusion. Excessive or extended glucocorticoid therapy is associated with avascular joint necrosis. Cyclosporine is administered orally at an initial dose of 12 mg/kg per day in adults (15 mg/kg per day in children), with subsequent adjustment according to blood levels obtained every 2 weeks. Trough levels should be between 150 and 200 ng/mL. The most important side effects of chronic cyclosporine treatment are nephrotoxicity, hypertension, seizures, and opportunistic infections, especially *Pneumocystis carinii* (prophylactic treatment with monthly inhaled pentamidine is recommended).

Most patients with aplastic anemia lack a suitable marrow donor, and immunosuppression is the treatment of choice. Overall survival is equivalent with transplantation and immunosuppression. However, successful transplant cures marrow failure, although patients who recover adequate blood counts after immunosuppression remain at risk of relapse and malignant evolution. Because of excellent results in children and younger adults, allogeneic transplant should be performed if a suitable sibling donor is available. Increasing age and the severity of neutropenia are the most important factors weighing in the decision between transplant and immunosuppression in adults who have a matched family donor: older patients do better with ATG and cyclosporine, whereas transplant is preferred if granulocytopenia is profound. Some patients may prefer immunosuppression; transplant is used for failure to recover blood counts or occurrence of late complications.

Outcomes following both transplant and immunosuppression have improved with time. High doses of cyclophosphamide, without stem cell rescue, have been reported to produce durable hematologic recovery, without relapse or evolution to MDS, but this treatment can produce sustained severe fatal neutropenia and response is often delayed. New immunosuppressive drugs in clinical trial may further improve outcome.

**OTHER THERAPIES** The effectiveness of androgens has not been verified in controlled trials, but occasional patients will respond or even demonstrate blood



count dependence on continued therapy. For patients with moderate disease or those with severe pancytopenia in whom immunosuppression has failed, a 3- to 4-month trial is appropriate. Hematopoietic growth factors, granulocyte colony-stimulating factor (G-CSF), granulocyte-macrophage CSF (GM-CSF), and interleukin 3 (IL-3) are not recommended as initial therapy for severe aplastic anemia, and even their role as adjuncts to immunosuppression is not well defined. Some patients may respond to combinations of growth factors after immunosuppression has failed.

**SUPPORTIVE CARE** Meticulous medical attention is required so that the patient may survive to benefit from definitive therapy or, having failed treatment, to maintain a reasonable existence in the face of pancytopenia. First and most important, infection in the presence of severe neutropenia must be aggressively treated by prompt institution of parenteral broad-spectrum antibiotics, usually ceftazidime or a combination of an aminoglycoside, cephalosporin, and semisynthetic penicillin. Therapy is empirical and must not await results of culture, although specific foci of infection such as oropharyngeal or anorectal abscesses, pneumonia, sinusitis, and typhlitis (necrotizing colitis) should be sought on physical examination and with radiographic studies. When indwelling plastic catheters become contaminated, vancomycin should be added. Persistent or recrudescing fever implies fungal disease: *Candida* and *Aspergillus* are common, especially after several courses of antibacterial antibiotics, and a progressive course may be averted by timely initiation of antifungal therapy. Granulocyte transfusions using G-CSF–mobilized peripheral blood have appeared to be effective in the treatment of overwhelming or refractory infections in a few patients. Hand washing, the single best method of preventing the spread of infection, remains a neglected practice. Nonabsorbed antibiotics for gut decontamination are poorly tolerated and not of proven value. Total reverse isolation does not reduce mortality from infections.

Both platelet and erythrocyte numbers can be maintained by transfusion. Alloimmunization historically limited the usefulness of platelet transfusions and is now minimized by several strategies, including use of single donors to reduce exposure and physical or chemical methods to diminish leukocytes in the product; HLA-matched platelets are often effective in patients refractory to random donor products. Inhibitors of fibrinolysis such as aminocaproic acid have not been shown to relieve mucosal oozing; the use of low-dose glucocorticoids to induce “vascular stability” is unproven and not recommended. Whether platelet transfusions are better used prophylactically or only as needed remains unclear. Any rational regimen of prophylaxis requires transfusions once or twice weekly in order to maintain

the platelet count  $>10,000/\mu\text{L}$  (oozing from the gut, and presumably also from other vascular beds, increases precipitously at counts  $<5000/\mu\text{L}$ ). Menstruation should be suppressed either by oral estrogens or nasal follicle-stimulating hormone/luteinizing hormone (FSH/LH) antagonists. Aspirin and other nonsteroidal anti-inflammatory agents inhibit platelet function and must be avoided.

Red blood cells should be transfused to maintain a normal level of activity, usually at a hemoglobin value of 70 g/L (90 g/L if there is underlying cardiac or pulmonary disease); a regimen of 2 units every 2 weeks will replace normal losses in a patient without a functioning bone marrow. In chronic anemia, the iron chelators deferoxamine and deferasirox should be added at around the fiftieth transfusion in order to avoid secondary hemochromatosis.

## PURE RED CELL APLASIA

Other, more restricted forms of marrow failure occur, in which only a single circulating cell type is affected and the aregenerative marrow shows corresponding absence or decreased numbers of specific precursor cells: aregenerative anemia as in PRCA (see later), thrombocytopenia with amegakaryocytosis (Chap. 18), and neutropenia without marrow myeloid cells in agranulocytosis (Chap. 5). In general, and in contrast to aplastic anemia and MDS, the unaffected lineages appear quantitatively and qualitatively normal. Agranulocytosis, the most frequent of these syndromes, is usually a complication of medical drug use (with agents similar to those related to aplastic anemia), either by a mechanism of direct chemical toxicity or by immune destruction. Agranulocytosis has an incidence similar to aplastic anemia but is especially frequent among the elderly and in women. The syndrome should resolve with discontinuation of exposure, but significant mortality is attached to neutropenia in the older and often previously unwell patient. Both pure white cell aplasia (agranulocytosis without incriminating drug exposure) and amegakaryocytic thrombocytopenia are exceedingly rare and, like PRCA, appear to be due to destructive antibodies or lymphocytes and can respond to immunosuppressive therapies. In all the single lineage failure syndromes, progression to pancytopenia or leukemia is unusual.

## DEFINITION AND DIFFERENTIAL DIAGNOSIS

PRCA is characterized by anemia, reticulocytopenia, and absent or rare erythroid precursor cells in the bone marrow. The classification of PRCA is shown in [Table 11-4](#).

TABLE 11-4

## CLASSIFICATION OF PURE RED CELL APLASIA

Self-limited
Transient erythroblastopenia of childhood
Transient aplastic crisis of hemolysis (acute B19 parvovirus infection)
Fetal red blood cell aplasia
Nonimmune hydrops fetalis (in utero B19 parvovirus infection)
Hereditary pure red cell aplasia
Congenital pure red cell aplasia (Diamond-Blackfan syndrome)
Acquired pure red cell aplasia
Thymoma and malignancy
Thymoma
Lymphoid malignancies (and more rarely other hematologic diseases)
Paraneoplastic to solid tumors
Connective tissue disorders with immunologic abnormalities
Systemic lupus erythematosus, juvenile rheumatoid arthritis, rheumatoid arthritis
Multiple endocrine gland insufficiency
Virus
Persistent B19 parvovirus, hepatitis, adult T cell leukemia virus, Epstein-Barr virus
Pregnancy
Drugs
Especially phenytoin, azathioprine, chloramphenicol, procainamide, isoniazid
Erythropoietin
Idiopathic

In adults, PRCA is acquired. An identical syndrome can occur constitutionally: Diamond-Blackfan anemia, or congenital PRCA, is diagnosed at birth or in early childhood and often responds to glucocorticoid treatment; a minority of patients have etiologic mutations in a ribosomal RNA processing gene called *RPS19*. Temporary red cell failure occurs in transient aplastic crisis of hemolytic anemias due to acute parvovirus infection and in transient erythroblastopenia of childhood, which affects normal children.

### CLINICAL ASSOCIATIONS AND ETIOLOGY

PRCA has important associations with immune system diseases. A small minority of cases occur with a thymoma. More frequently, red cell aplasia can be the major manifestation of large granular lymphocytosis or may occur in chronic lymphocytic leukemia. Some patients may be hypogammaglobulinemic. As with agranulocytosis, PRCA can be due to an idiosyncratic reaction to a drug. Subcutaneous administration of erythropoietin can lead to PRCA mediated by neutralizing antibodies.

Like aplastic anemia, PRCA results from diverse mechanisms. Antibodies to red blood cell precursors are frequently present in the blood, but T cell inhibition is probably the more common immune mechanism. Cytotoxic lymphocyte activity restricted by histocompatibility locus or specific for human T cell leukemia/lymphoma virus I-infected cells, as well as natural killer cell activity inhibitory of erythropoiesis, has been demonstrated in particularly well-studied individual cases.

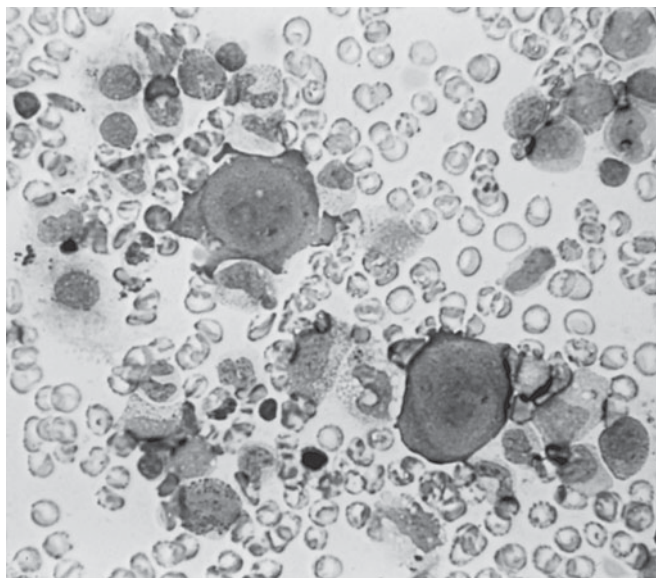
### Persistent Parvovirus B19 Infection

Chronic parvovirus infection is an important, treatable cause of PRCA. This common virus causes a benign exanthem of childhood (fifth disease) and a polyarthralgia/arthritis syndrome in adults. In patients with underlying hemolysis (or any condition that increases demand for red blood cell production), parvovirus infection can cause a transient aplastic crisis and an abrupt but temporary worsening of the anemia due to failed erythropoiesis. In normal individuals, acute infection is resolved by production of neutralizing antibodies to the virus, but in the setting of congenital, acquired, or iatrogenic immunodeficiency, persistent viral infection may occur. The bone marrow shows red cell aplasia and the presence of giant pronormoblasts (Fig. 11-2), which is the cytopathic sign of B19 parvovirus infection. Viral tropism for human erythroid progenitor cells is due to its use of erythrocyte P antigen as a cellular receptor for entry. Direct cytotoxicity of virus causes anemia if demands on erythrocyte production are high; in normal individuals, the temporary cessation of red cell production is not clinically apparent, and skin and joint symptoms are mediated by immune complex deposition.

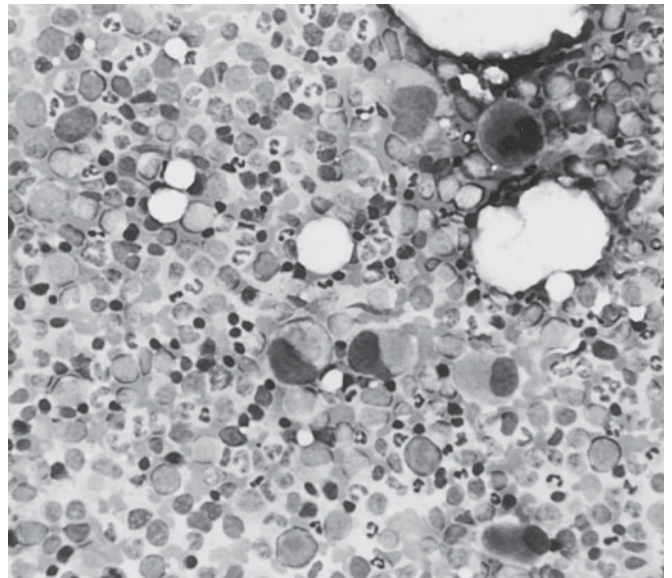
#### **Rx Treatment:** **PURE RED CELL APLASIA**

History, physical examination, and routine laboratory studies may disclose an underlying disease or a suspect drug exposure. Thymoma should be sought by radiographic procedures. Tumor excision is indicated, but anemia does not necessarily improve with surgery. The diagnosis of parvovirus infection requires detection of viral DNA sequences in the blood (IgG and IgM antibodies are commonly absent). The presence of erythroid colonies has been considered predictive of response to immunosuppressive therapy in idiopathic PRCA.

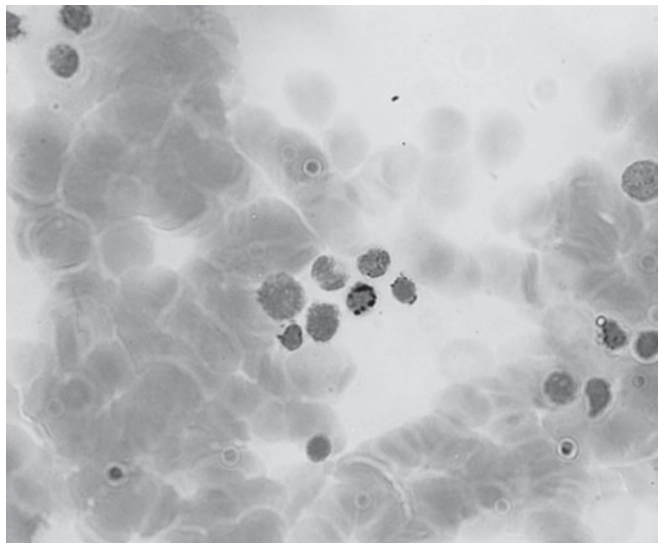
Red cell aplasia is compatible with long survival with supportive care alone: a combination of erythrocyte transfusions and iron chelation. For persistent B19 parvovirus



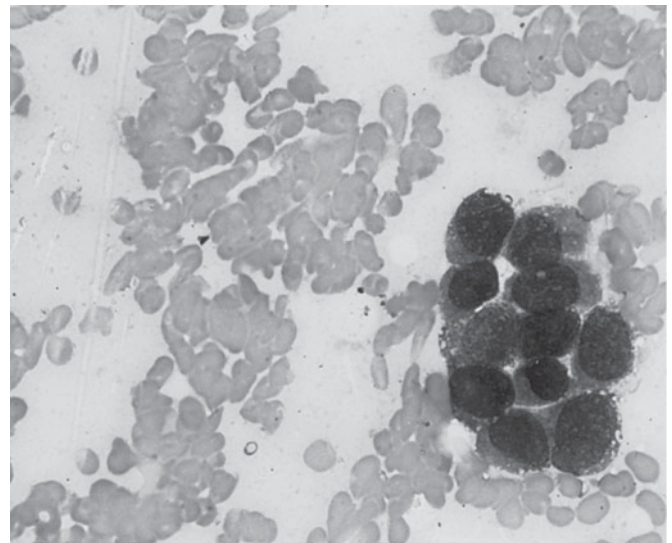
A



B



C



D

### FIGURE 11-2

**Pathognomonic cells in marrow failure syndromes.** **A.** Giant pronormoblast, the cytopathic effect of B19 parvovirus infection of the erythroid progenitor cell. **B.** Uninuclear megakaryocyte and microblastic erythroid precursors typical

of the 5q<sup>-</sup> myelodysplasia syndrome. **C.** Ringed sideroblast showing perinuclear iron granules. **D.** Tumor cells present on a touch preparation made from the marrow biopsy of a patient with metastatic carcinoma.

infection, almost all patients respond to intravenous immunoglobulin therapy (e.g., 0.4 g/kg daily for 5 days), although relapse and retreatment may be expected, especially in patients with AIDS. Most patients with idiopathic PRCA respond favorably to immunosuppression. Most first receive a course of glucocorticoids. Also effective are cyclosporine, ATG, azathioprine, cyclophosphamide, and the monoclonal antibody daclizumab, an antibody to the IL-2 receptor. PRCA developing on erythropoietin therapy should be treated with immunosuppression and withdrawal of erythropoietin.

## MYELOUDYPLASIA

### DEFINITION

The myelodysplasias (MDSs) are a heterogeneous group of hematologic disorders broadly characterized by cytopenias associated with a dysmorphic (or abnormal appearing) and usually cellular bone marrow, and by consequent ineffective blood cell production. A clinically useful nosology of these entities was first developed by the French-American-British Cooperative Group in 1983. Five entities were defined: refractory anemia (RA),

refractory anemia with ringed sideroblasts (RARS), refractory anemia with excess blasts (RAEB), refractory anemia with excess blasts in transformation (RAEB-t), and chronic myelomonocytic leukemia (CMML). The World Health Organization classification (2002) recognizes that the distinction between RAEB-t and acute myeloid leukemia is arbitrary and groups them together as acute leukemia, notes that CMML behaves as a myeloproliferative disease, and separates refractory anemias with dysmorphic change restricted to erythroid lineage from those with multilineage changes (Table 11-5).

## EPIDEMIOLOGY

Idiopathic MDS is a disease of the elderly; the mean age at onset is 68 years. There is a slight male preponderance.

MDS is a relatively common form of bone marrow failure, with reported incidence rates of 35 to >100 per million persons in the general population and 120 to >500 per million in the elderly. MDS is rare in children, but monocytic leukemia can be seen. Therapy-related MDS is not age-related and may occur in as many as 15% of patients within a decade following intensive combined modality treatment for cancer. Rates of MDS have increased over time, due to the recognition of the syndrome by physicians and the aging of the population.

## ETIOLOGY AND PATHOPHYSIOLOGY

MDS is caused by environmental exposures such as radiation and benzene; other risk factors have been reported inconsistently. Secondary MDS occurs as a late toxicity

**TABLE 11-5**

### WORLD HEALTH ORGANIZATION CLASSIFICATION OF MYELODYSPLASTIC SYNDROMES

DISEASE	FREQUENCY	BLOOD FINDINGS	BONE MARROW FINDINGS	PROGNOSIS
Refractory anemia (RA)	5–10%	Anemia No or rare blasts	Erythroid dysplasia only <5% blasts <15% ringed sideroblasts	Protracted course Leukemic transformation in ~6%
Refractory anemia with ringed sideroblasts (RARS)	10–12%	Anemia No blasts	Erythroid dysplasia only ≥15% ringed sideroblasts <5% blasts	Protracted course Leukemia in ~1–2%
Refractory cytopenia with multilineage dysplasia (RCMD)	24%	Cytopenias (2 or 3 lineages) No or rare blasts No Auer rods <1 × 10 <sup>9</sup> /L monocytes	Dysplasia in ≥10% of cells in ≥2 lineages <5% blasts No Auer rods <15% ringed sideroblasts	Variable clinical course Leukemia in ~11%
RCMD with ringed sideroblasts (RCMD-RS)	15%	Cytopenias (2 or 3 lineages) No or rare blasts No Auer rods <1 × 10 <sup>9</sup> /L monocytes	Dysplasia in ≥10% of cells in ≥2 lineages ≥15% ringed sideroblasts <5% blasts No Auer rods	
Refractory anemia with excess blasts-1 (RAEB-1)	40% (RAEB-1 +2)	Cytopenias <5% blasts No Auer rods <1 × 10 <sup>9</sup> /L monocytes	Unilineage or multilineage dysplasia 5–9% blasts No Auer rods	Progressive BM failure Leukemia in ~25%
Refractory anemia with excess blasts-2 (RAEB-2)		Cytopenias 5–19% blasts ±Auer rods <1 × 10 <sup>9</sup> /L monocytes	Unilineage or multilineage dysplasia 10–19% blasts ±Auer rods	Progressive BM failure Leukemia in ~33%
Myelodysplastic syndrome, unclassified (MDS-U)	Unknown	Cytopenias No or rare blasts No Auer rods	Dysplasia in myeloid or platelet lineage <5% blasts No Auer rods	Unknown
MDS with isolated del(5q)	Unknown	Anemia <5% blasts Platelets nl or increased	NI or increased megakaryocytes with hypolobated nuclei <5% blasts No Auer rods Isolated del(5q)	Long survival

**Note:** BM, bone marrow.

**Source:** Extracted from Jaffe ES et al (eds): *Pathology and Genetics of Tumors of Haematopoietic and Lymphoid Tissues*. Lyon, IARC Press, 2001.

140 of cancer treatment, usually with a combination of radiation and the radiomimetic alkylating agents such as busulfan, nitrosourea, or procarbazine (with a latent period of 5–7 years) or the DNA topoisomerase inhibitors (2 years). Both acquired aplastic anemia following immunosuppressive treatment and Fanconi's anemia can evolve into MDS.

MDS is a clonal hematopoietic stem cell disorder leading to impaired cell proliferation and differentiation. Cytogenetic abnormalities are found in about half of patients, and some of the same specific lesions are also seen in frank leukemia; aneuploidy is more frequent than translocations. Both presenting and evolving hematologic manifestations result from the accumulation of multiple genetic lesions: loss of tumor suppressor genes, activating oncogene mutations, or other harmful alterations. Cytogenetic abnormalities are not random (loss of all or part of 5, 7, and 20, trisomy of 8) and may be related to etiology (11q23 following topoisomerase II inhibitors); chronic myelomonocytic leukemia is often associated with t(5;12) that creates a chimeric *tel-PDGFβ* gene. The type and number of cytogenetic abnormalities strongly correlate with the probability of leukemic transformation and survival. Mutations of *N-ras* (an oncogene), *p53* and *IRF-1* (tumor suppressor genes), *Bcl-2* (an antiapoptotic gene), and others have been reported in some patients but likely occur late in the sequence leading to leukemic transformation. Apoptosis of marrow cells is increased in MDS, presumably due to these acquired genetic alterations or possibly to an overlaid immune response. An immune pathophysiology has been suggested for trisomy 8 MDS, which often responds clinically to immunosuppressive therapy. Such patients have T cell activity directed to the cytogenetically aberrant clone. Sideroblastic anemia may be related to mutations in mitochondrial genes; ineffective erythropoiesis and disordered iron metabolism are the functional consequences of the genetic alterations.

## CLINICAL FEATURES

Anemia dominates the early course. Most symptomatic patients complain of the gradual onset of fatigue and weakness, dyspnea, and pallor, but at least half the patients are asymptomatic and their MDS is discovered only incidentally on routine blood counts. Previous chemotherapy or radiation exposure is an important historic fact. Fever and weight loss should point to a myeloproliferative rather than myelodysplastic process. Children with Down syndrome are susceptible to MDS, and a family history may indicate a hereditary form of sideroblastic anemia or Fanconi's anemia.

The physical examination is remarkable for signs of anemia; ~20% of patients have splenomegaly. Some unusual skin lesions, including Sweet's syndrome (febrile neutrophilic dermatosis), occur with MDS. Autoimmune syndromes are not infrequent.

## LABORATORY STUDIES

### Blood

Anemia is present in most cases, either alone or as part of bi- or pancytopenia; isolated neutropenia or thrombocytopenia is more unusual. Macrocytosis is common, and the smear may be dimorphic with a distinctive population of large red blood cells. Platelets are also large and lack granules. In functional studies, they may show marked abnormalities, and patients may have bleeding symptoms despite seemingly adequate numbers. Neutrophils are hypogranulated; have hyposegmented, ringed, or abnormally segmented nuclei; contain Döhle bodies; and may be functionally deficient. Circulating myeloblasts usually correlate with marrow blast numbers, and their quantitation is important for classification and prognosis. The total white blood cell count is usually normal or low, except in chronic myelomonocytic leukemia. As in aplastic anemia, MDS can be associated with a clonal population of PNH cells.

### Bone Marrow

The bone marrow is usually normal or hypercellular, but in 20% of cases it is sufficiently hypocellular to be confused with aplasia. No single characteristic feature of marrow morphology distinguishes MDS, but the following are commonly observed: dyserythropoietic changes (especially nuclear abnormalities) and ringed sideroblasts in the erythroid lineage; hypogranulation and hyposegmentation in granulocytic precursors, with an increase in myeloblasts; and megakaryocytes showing reduced numbers or disorganized nuclei. Megaloblastic nuclei associated with defective hemoglobinization in the erythroid lineage are common. Prognosis strongly correlates with the proportion of marrow blasts. Cytogenetic analysis and fluorescent in situ hybridization can identify chromosomal abnormalities.

## DIFFERENTIAL DIAGNOSIS

Deficiencies of vitamin B<sub>12</sub> or folate should be excluded by appropriate blood tests; vitamin B<sub>6</sub> deficiency can be assessed by a therapeutic trial of pyridoxine if the bone marrow shows ringed sideroblasts. Marrow dysplasia can be observed in acute viral infections, drug reactions, or chemical toxicity but should be transient. More difficult are the distinctions between hypocellular MDS and aplasia or between refractory anemia with excess blasts and early acute leukemia. The World Health Organization considers the presence of 20% blasts in the marrow as the criterion that separates acute myeloid leukemia from MDS.

## PROGNOSIS

The median survival varies greatly from years for patients with 5q- or sideroblastic anemia to a few months in

TABLE 11-6

## INTERNATIONAL PROGNOSTIC SCORING SYSTEM

PROGNOSTIC VARIABLE	SCORE VALUE				
	0	0.5	1.0	1.5	2.0
Bone marrow blasts (%)	<5%	5–10%		11–20%	21–30%
Karyotype <sup>a</sup>	Good	Intermediate	Poor		
Cytopenia <sup>b</sup> (lineages affected)	0 or 1	2 or 3			
<b>Risk Group Scores</b>	<b>Score</b>				
Low	0				
Intermediate-1	0.5–1.0				
Intermediate-2	1.5–2.0				
High	≥2.5				

<sup>a</sup>Good, normal, -Y, del(5q), del(20q); poor, complex (≥3 abnormalities) or chromosome 7 abnormalities; intermediate, all other abnormalities.

<sup>b</sup>Cytopenias defined as Hb <100 g/L, platelet count <100,000/μL, absolute neutrophil count <1500/μL.

refractory anemia with excess blasts or severe pancytopenia associated with monosomy 7; an International Prognostic Scoring System (Table 11-6) assists in making predictions. Most patients die as a result of complications of pancytopenia and not due to leukemic transformation; perhaps a third succumb to other diseases unrelated to their MDS. Precipitous worsening of pancytopenia, acquisition of new chromosomal abnormalities on serial cytogenetic determination, and increase in the number of blasts are all poor prognostic indicators. The outlook in therapy-related MDS, regardless of type, is very poor, and most patients progress within a few months to refractory acute myeloid leukemia.

### Rx Treatment: MYELODYSPLASIA

The therapy of MDS has been unsatisfactory. Only stem cell transplantation offers cure: survival rates of 50% at 3 years have been reported, but older patients are particularly prone to develop treatment-related mortality and morbidity. Results of transplant using matched unrelated donors are comparable, although most series contain younger and more highly selected cases.

MDS has been regarded as particularly refractory to cytotoxic chemotherapy regimens but is probably no more resistant to effective treatment than acute myeloid leukemia in the elderly, in whom drug toxicity is often fatal and remissions, if achieved, are brief.

Low doses of cytotoxic drugs have been administered for their “differentiating” potential, and from this experience has emerged drug therapies based on pyrimidine analogues. Azacitidine is directly cytotoxic but also inhibits DNA methylation, thereby altering gene expression. Azacitidine improves blood counts and modestly improves survival in ~16% of MDS

patients, compared to best supportive care. Azacitidine is administered subcutaneously at a dose of 75 mg/m<sup>2</sup>, daily for 7 days, at 4-week intervals, for at least four cycles, although further cycles may be required to observe a response. Decitabine is closely related to azacitidine and more potent. Similar to azacitidine, ~20% of patients show responses in blood counts, with a duration of response of almost a year. Activity may be higher in more advanced MDS subtypes. Decitabine dose is 15 mg/m<sup>2</sup> by continuous intravenous infusion, every 8 hours for 3 days, repeating the cycle every 6 weeks for at least four cycles. The major toxicity of both azacitidine and decitabine is myelosuppression, leading to worsened blood counts. Other symptoms associated with cancer chemotherapy frequently occur. Ironically, it has been difficult to establish that either agent acts in patients by a mechanism of DNA demethylation.

Thalidomide, a drug with many activities including antiangiogenesis and immunomodulation, has modest biologic activity in MDS. Lenalidomide, a thalidomide derivative with a more favorable toxicity profile, is particularly effective in reversing anemia in MDS patients with 5q- syndrome; not only do a high proportion of these patients become transfusion-independent with normal or near-normal hemoglobin levels, but their cytogenetics also become normal. Lenalidomide is administered orally, 10 mg daily. Most patients improve within 3 months of initiating therapy. Toxicities include myelosuppression (worsening thrombocytopenia and neutropenia, necessitating blood count monitoring) and an increased risk of deep vein thrombosis and pulmonary embolism.

Other treatments for MDS include amifostine, an organic thiophosphonate that blocks apoptosis; it can improve blood counts but has significant toxicities. ATG and cyclosporine, as employed in aplastic anemia, also

may produce sustained independence from transfusion, especially in younger MDS patients with more favorable International Prognostic Scoring System (IPSS) scores.

Hematopoietic growth factors can improve blood counts but, as in most other marrow failure states, have been most beneficial to patients with the least severe pancytopenia. G-CSF treatment alone failed to improve survival in a controlled trial. Erythropoietin alone or in combination with G-CSF can improve hemoglobin levels, but mainly in those with low serum erythropoietin levels who have no or only a modest need for transfusions.

The same principles of supportive care described for aplastic anemia apply to MDS. Despite improvements in drug therapy, many patients will be anemic for years. RBC transfusion support should be accompanied by iron chelation to prevent secondary hemochromatosis.

## MYELOPHTHISIC ANEMIAS

Fibrosis of the bone marrow (see Fig. 13-2), usually accompanied by a characteristic blood smear picture called *leukoerythroblastosis*, can occur as a primary hematologic disease, called *myelofibrosis* or *myeloid metaplasia* (Chap. 13), and as a secondary process, called *myelophthisis*. Myelophthisis, or secondary myelofibrosis, is reactive. Fibrosis can be a response to invading tumor cells, usually an epithelial cancer of breast, lung, a prostate origin or neuroblastoma. Marrow fibrosis may occur with infection of mycobacteria (both *Mycobacterium tuberculosis* and *M. avium*), fungi, or HIV, and in sarcoidosis. Intracellular lipid deposition in Gaucher's disease and obliteration of the marrow space related to absence of osteoclast remodeling in congenital osteopetrosis also can produce fibrosis. Secondary myelofibrosis is a late consequence of radiation therapy or treatment with radiomimetic drugs. Usually the infectious or malignant underlying processes are obvious. Marrow fibrosis can also be a feature of a variety of hematologic syndromes, especially chronic myeloid leukemia, multiple myeloma, lymphomas, myeloma, and hairy cell leukemia.

The pathophysiology has three distinct features: proliferation of fibroblasts in the marrow space (myelofibrosis); the extension of hematopoiesis into the long bones and into extramedullary sites, usually the spleen, liver, and lymph nodes (myeloid metaplasia); and ineffective erythropoiesis. The etiology of the fibrosis is unknown but

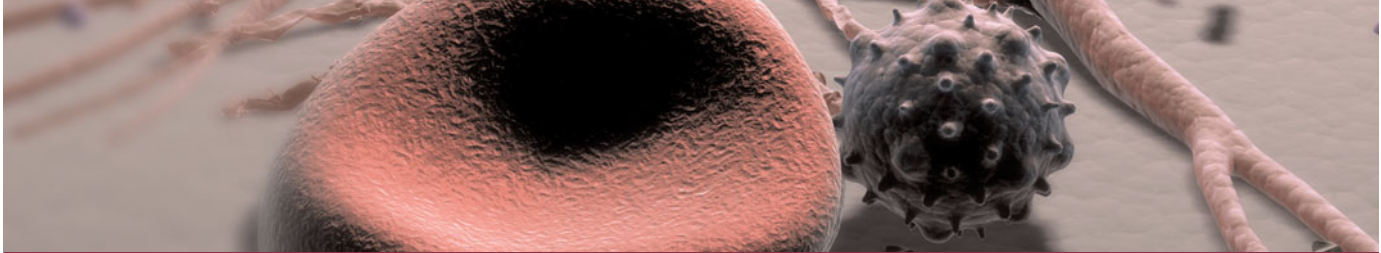
most likely involves dysregulated production of growth factors: platelet-derived growth factor and transforming growth factor  $\beta$  have been implicated. Abnormal regulation of other hematopoietins would lead to localization of blood-producing cells in nonhematopoietic tissues and uncoupling of the usually balanced processes of stem cell proliferation and differentiation. Myelofibrosis is remarkable for pancytopenia despite very large numbers of circulating hematopoietic progenitor cells.

Anemia is dominant in secondary myelofibrosis, usually normocytic and normochromic. The diagnosis is suggested by the characteristic leukoerythroblastic smear (see Fig. 13-1). Erythrocyte morphology is highly abnormal, with circulating nucleated red blood cells, teardrops, and shape distortions. White blood cell numbers are often elevated, sometimes mimicking a leukemoid reaction, with circulating myelocytes, promyelocytes, and myeloblasts. Platelets may be abundant and are often of giant size. Inability to aspirate the bone marrow, the characteristic "dry tap," can allow a presumptive diagnosis in the appropriate setting before the biopsy is decalcified.

The course of secondary myelofibrosis is determined by its etiology, usually a metastatic tumor or an advanced hematologic malignancy. Treatable causes must be excluded, especially tuberculosis and fungus. Transfusion support can relieve symptoms.

## FURTHER READINGS

- BACIGALUPO A, PASSWEG J: Diagnosis and treatment of acquired aplastic anemia. *Hematol Oncol Clin North Am* 23:159, 2009
- BAGBY GC, ALTER BP: Fanconi anemia. *Semin Hematol* 43:147, 2006
- ESTEY E et al: Acute myeloid leukemia and myelodysplastic syndromes in older patients. *J Clin Oncol* 25:1908, 2007
- FISCH P et al: Pure red cell aplasia. *Br J Haematol* 111:1010, 2000
- GREEN AM, KUPFER GM: Fanconi anemia. *Hematol Oncol Clin North Am* 23:193, 2009
- KIRWAN M, DOKAL I: Dyskeratosis congenital, stem cells and telomeres. *Biochim Biophys Acta* 1792:371, 2009
- LIPTON JM: Diamond Blackfan anemia: New paradigms for a "not so pure" inherited red cell aplasia. *Semin Hematol* 43:167, 2006
- LIST A et al: Efficacy of lenalidomide in myelodysplastic syndromes. *N Engl J Med* 352:549, 2005
- WU Y et al: Welcome the family of FANCF-like helicases to the block of genome stability maintenance proteins. *Cell Mol Life Sci* 66:1209, 2009
- YOUNG NS, BROWN KE: Parvovirus B19. *N Engl J Med* 350:586, 2004
- YOUNG et al: Current concepts in the pathophysiology and treatment of aplastic anemia. *Blood* 108:2509, 2006



## CHAPTER 12

# TRANSFUSION BIOLOGY AND THERAPY

Jeffery S. Dzieczkowski ■ Kenneth C. Anderson

■ Blood Group Antigens and Antibodies . . . . .	.143	Fresh-Frozen Plasma . . . . .	.147
ABO Antigens and Antibodies . . . . .	.143	Cryoprecipitate . . . . .	.147
Rh System . . . . .	.144	Plasma Derivatives . . . . .	.147
Other Blood Group Systems and Alloantibodies . . . . .	.144	■ Adverse Reactions to Blood Transfusion . . . . .	.147
■ Pretransfusion Testing . . . . .	.145	Immune-Mediated Reactions . . . . .	.147
■ Blood Components . . . . .	.145	Nonimmunologic Reactions . . . . .	.150
Whole Blood . . . . .	.146	Infectious Complications . . . . .	.150
Packed Red Blood Cells . . . . .	.146	■ Alternatives to Transfusion . . . . .	.151
Platelets . . . . .	.146	■ Further Readings . . . . .	.152

### BLOOD GROUP ANTIGENS AND ANTIBODIES

The study of red blood cell (RBC) antigens and antibodies forms the foundation of transfusion medicine. Serologic studies initially characterized these antigens, but now the molecular composition and structure of many are known. Antigens, either carbohydrate or protein, are assigned to a blood group system based on the structure and similarity of the determinant epitopes. Other cellular blood elements and plasma proteins are also antigenic and can result in *alloimmunization*, the production of antibodies directed against the blood group antigens of another individual. These antibodies are called *alloantibodies*.

Antibodies directed against RBC antigens may result from “natural” exposure, particularly to carbohydrates that mimic some blood group antigens. Those antibodies that occur via natural stimuli are usually produced by a T cell–independent response (thus generating no memory) and are IgM isotype. *Autoantibodies* (antibodies against autologous blood group antigens) arise spontaneously or as the result of infectious sequelae (e.g., from *Mycoplasma pneumoniae*) and are also often IgM. These antibodies are often clinically insignificant due to their low affinity for antigen at body temperature. However, IgM antibodies can activate the complement cascade

and result in hemolysis. Antibodies that result from allogeneic exposure, such as transfusion or pregnancy, are usually IgG. IgG antibodies commonly bind to antigen at warmer temperatures and may hemolyze RBCs. Unlike IgM antibodies, IgG antibodies can cross the placenta and bind fetal erythrocytes bearing the corresponding antigen, resulting in hemolytic disease of the newborn, or *hydrops fetalis*.

Alloimmunization to leukocytes, platelets, and plasma proteins may also result in transfusion complications such as fevers and urticaria but generally does not cause hemolysis. Assay for these other alloantibodies is not routinely performed; however, they may be detected using special assays.

### ABO ANTIGENS AND ANTIBODIES

The first blood group antigen system, recognized in 1900, was ABO, the most important in transfusion medicine. The major blood groups of this system are A, B, AB, and O. O type RBCs lack A or B antigens. These antigens are carbohydrates attached to a precursor backbone, may be found on the cellular membrane either as glycosphingolipids or glycoproteins, and are secreted into plasma and body fluids as glycoproteins. H substance is the immediate precursor on which the A and B antigens are added. This H substance is formed by the



144 addition of fucose to the glycolipid or glycoprotein backbone. The subsequent addition of *N*-acetylgalactosamine creates the A antigen; the addition of galactose produces the B antigen.

The genes that determine the A and B phenotypes are found on chromosome 9p and expressed in a Mendelian codominant manner. The gene products are glycosyl transferases, which confer the enzymatic capability of attaching the specific antigenic carbohydrate. Individuals who lack the “A” and “B” transferases are phenotypically type “O”; those who inherit both transferases are type “AB.” Rare individuals lack the H gene, which codes for fucose transferase and cannot form H substance. These individuals are homozygous for the silent h allele (hh) and have Bombay phenotype (O<sub>h</sub>).

The ABO blood group system is important because essentially all individuals produce antibodies to the ABH carbohydrate antigen that they lack. The naturally occurring anti-A and anti-B antibodies are termed *isoagglutinins*. Thus type A individuals produce anti-B, and type B individuals make anti-A. Neither isoagglutinin is found in type AB individuals, and type O individuals produce both anti-A and anti-B. Thus persons with type AB are “universal recipients” because they do not have antibodies against any ABO phenotype; persons with type O blood can donate to essentially all recipients because their cells are not recognized by any ABO isoagglutinins. The rare individuals with Bombay phenotype produce antibodies to H substance (which is present on all red cells except those of hh phenotype) as well as to both A and B antigens and are therefore compatible only with other hh donors.

In most people, A and B antigens are secreted by the cells and are present in the circulation. Nonsecretors are susceptible to a variety of infections (e.g., *Candida albicans*, *Neisseria meningitidis*, *Streptococcus pneumoniae*, *Haemophilus influenzae*) because many organisms may

bind to polysaccharides on cells. Soluble blood group antigens may block this binding.

## Rh SYSTEM

The Rh system is the second most important blood group system in pretransfusion testing. The Rh antigens are found on a 30- to 32-kDa RBC membrane protein that has no defined function. Although >40 different antigens in the Rh system have been described, five determinants account for the vast majority of phenotypes. The presence of the D antigen confers Rh “positivity”; persons who lack the D antigen are Rh negative. Two allelic antigen pairs, E/e and C/c, are also found on the Rh protein. The three Rh genes, E/e, D, and C/c, are arranged in tandem on chromosome 1 and inherited as a haplotype, i.e., cDE or Cde. Two haplotypes can result in the phenotypic expression of two to five Rh antigens.

The D antigen is a potent alloantigen. About 15% of individuals lack this antigen. Exposure of these Rh-negative people to even small amounts of Rh-positive cells, by either transfusion or pregnancy, can result in the production of anti-D alloantibody.

## OTHER BLOOD GROUP SYSTEMS AND ALLOANTIBODIES

More than 100 blood group systems are recognized, composed of >500 antigens. The presence or absence of certain antigens has been associated with various diseases and anomalies; antigens also act as receptors for infectious agents. Alloantibodies of importance in routine clinical practice are listed in [Table 12-1](#).

Antibodies to *Lewis system* carbohydrate antigens are the most common cause of incompatibility during pretransfusion screening. The Lewis gene product is a fucosyl transferase and maps to chromosome 19. The antigen is

**TABLE 12-1**

**RBC BLOOD GROUP SYSTEMS AND ALLOANTIGENS**

BLOOD GROUP SYSTEM	ANTIGEN	ALLOANTIBODY	CLINICAL SIGNIFICANCE
Rh (D, C/c, E/e)	RBC protein	IgG	HTR, HDN
Lewis (Le <sup>a</sup> , Le <sup>b</sup> )	Oligosaccharide	IgM/IgG	Rare HTR
Kell (K/k)	RBC protein	IgG	HTR, HDN
Duffy (Fy <sup>a</sup> /Fy <sup>b</sup> )	RBC protein	IgG	HTR, HDN
Kidd (Jk <sup>a</sup> /Jk <sup>b</sup> )	RBC protein	IgG	HTR (often delayed), HDN (mild)
I/i	Carbohydrate	IgM	None
MNSsU	RBC protein	IgM/IgG	Anti-M rare HDN, anti-S, -s, and -U HDN, HTR

**Note:** RBC, red blood cell; HDN, hemolytic disease of the newborn; HTR, hemolytic transfusion reaction.

not an integral membrane structure but is adsorbed to the RBC membrane from the plasma. Antibodies to Lewis antigens are usually IgM and cannot cross the placenta. Lewis antigens may be adsorbed onto tumor cells and may be targets of therapy.

*I system* antigens are also oligosaccharides related to H, A, B, and Le. I and i are not allelic pairs but are carbohydrate antigens that differ only in the extent of branching. The i antigen is an unbranched chain converted by the I gene product, a glycosyltransferase, into a branched chain. The branching process affects all the ABH antigens, which become progressively more branched in the first 2 years of life. Some patients with cold agglutinin disease or lymphomas can produce anti-I autoantibodies that cause RBC destruction. Occasional patients with mononucleosis or *Mycoplasma pneumonia* may develop cold agglutinins of either anti-I or anti-i specificity. Most adults lack i expression; thus finding a donor for patients with anti-i is not difficult. Even though most adults express I antigen, binding is generally low at body temperature. Thus administration of warm blood prevents isoagglutination.

The *P system* is another group of carbohydrate antigens controlled by specific glycosyltransferases. Its clinical significance is in rare cases of syphilis and viral infection that lead to paroxysmal cold hemoglobinuria. In these cases, an unusual autoantibody to P is produced that binds to RBCs in the cold and fixes complement upon warming. Antibodies with these biphasic properties are called *Donath-Landsteiner antibodies*. The P antigen is the cellular receptor of parvovirus B19 and also may be a receptor for *Escherichia coli* binding to urothelial cells.

The *MNSsU system* is regulated by genes on chromosome 4. M and N are determinants on glycophorin A, an RBC membrane protein, and S and s are determinants on glycophorin B. Anti-S and anti-s IgG antibodies may develop after pregnancy or transfusion and lead to hemolysis. Anti-U antibodies are rare but problematic; virtually every donor is incompatible because nearly all persons express U.

The *Kell* protein is very large (720 amino acids), and its secondary structure contains many different antigenic epitopes. The immunogenicity of Kell is third behind the ABO and Rh systems. The absence of the Kell precursor protein (controlled by a gene on X) is associated with acanthocytosis, shortened RBC survival, and a progressive form of muscular dystrophy that includes cardiac defects. This rare condition is called the *McLeod phenotype*. The  $K_x$  gene is linked to the 91-kDa component of the NADPH-oxidase on the X chromosome, deletion or mutation of which accounts for ~60% of cases of chronic granulomatous disease.

The *Duffy* antigens are codominant alleles,  $Fy^a$  and  $Fy^b$ , that also serve as receptors for *Plasmodium vivax*. More than 70% of persons in malaria-endemic areas lack these antigens, probably from selective influences of the infection on the population.

The *Kidd* antigens,  $Jk^a$  and  $Jk^b$ , may elicit antibodies transiently. A delayed hemolytic transfusion reaction that occurs with blood tested as compatible is often related to delayed appearance of anti- $Jk^a$ .

## PRETRANSFUSION TESTING

Pretransfusion testing of a potential recipient consists of the “type and screen.” The “forward type” determines the ABO and Rh phenotype of the recipient’s RBC by using antisera directed against the A, B, and D antigens. The “reverse type” detects isoagglutinins in the patient’s serum and should correlate with the ABO phenotype, or forward type.

The alloantibody screen identifies antibodies directed against other RBC antigens. The alloantibody screen is performed by mixing patient serum with type O RBCs that contain the major antigens of most blood group systems and whose extended phenotype is known. The specificity of the alloantibody is identified by correlating the presence or absence of antigen with the results of the agglutination.

Cross-matching is ordered when there is a high probability that the patient will require a packed RBC (PRBC) transfusion. Blood selected for cross-matching must be ABO compatible and lack antigens for which the patient has alloantibodies. Nonreactive cross-matching confirms the absence of any major incompatibility and reserves that unit for the patient.

In the case of Rh-negative patients, every attempt must be made to provide Rh-negative blood components to prevent alloimmunization to the D antigen. In an emergency, Rh-positive blood can be safely transfused to an Rh-negative patient who lacks anti-D; however, the recipient is likely to become alloimmunized and produce anti-D. Rh-negative women of childbearing age who are transfused with products containing Rh-positive RBCs should receive passive immunization with anti-D (RhoGam or WinRho) to reduce or prevent sensitization.

## BLOOD COMPONENTS

Blood products intended for transfusion are routinely collected as whole blood (450 mL) in various anticoagulants. Most donated blood is processed into components: PRBCs, platelets, and fresh-frozen plasma (FFP) or cryoprecipitate ([Table 12-2](#)). Whole blood is first separated into PRBCs and platelet-rich plasma by slow centrifugation. The platelet-rich plasma is then centrifuged at high speed to yield one unit of random donor (RD) platelets and one unit of FFP. Cryoprecipitate is produced by thawing FFP to precipitate the plasma proteins, then separated by centrifugation.

## CHARACTERISTICS OF SELECTED BLOOD COMPONENTS

COMPONENT	VOLUME, mL	CONTENT	CLINICAL RESPONSE
PRBC	180–200	RBCs with variable leukocyte content and small amount of plasma	Increase hemoglobin 10 g/L and hematocrit 3%
Platelets	50–70	$5.5 \times 10^{10}$ /RD unit	Increase platelet count 5000–10,000/ $\mu$ L
	200–400	$\geq 3.0 \times 10^{11}$ /SDAP product	CCI $\geq 10 \times 10^9$ /L within 1 h and $\geq 7.5 \times 10^9$ /L within 24 h posttransfusion
FFP	200–250	Plasma proteins—coagulation factors, proteins C and S, antithrombin	Increases coagulation factors ~2%
Cryoprecipitate	10–15	Cold-insoluble plasma proteins, fibrinogen, factor VIII, vWF	Topical fibrin glue, also 80 IU factor VIII

**Note:** PRBC, packed red blood cells; RBC, red blood cell; RD, random donor; SDAP, single-donor apheresis platelets; CCI, corrected count increment; FFP, fresh-frozen plasma; vWF, von Willebrand's factor.

Apheresis technology is used for the collection of multiple units of platelets from a single donor. These single-donor apheresis platelets (SDAP) contain the equivalent of at least 6 units of RD platelets and have fewer contaminating leukocytes than pooled RD platelets.

Plasma may also be collected by apheresis. Plasma derivatives such as albumin, intravenous immunoglobulin, antithrombin, and coagulation factor concentrates are prepared from pooled plasma from many donors and are treated to eliminate infectious agents.

## WHOLE BLOOD

Whole blood provides both oxygen-carrying capacity and volume expansion. It is the ideal component for patients who have sustained acute hemorrhage of  $\geq 25\%$  total blood volume loss. Whole blood is stored at 4°C to maintain erythrocyte viability, but platelet dysfunction and degradation of some coagulation factors occurs. In addition, 2,3-bisphosphoglycerate levels fall over time, leading to an increase in the oxygen affinity of the hemoglobin and a decreased capacity to deliver oxygen to the tissues, a problem with all red cell storage. Whole blood is not readily available because it is routinely processed into components.

## PACKED RED BLOOD CELLS

This product increases oxygen-carrying capacity in the anemic patient. Adequate oxygenation can be maintained with a hemoglobin content of 70 g/L in the normovolemic patient without cardiac disease; however, comorbid factors often necessitate transfusion at a higher threshold. The decision to transfuse should be guided by the clinical situation and not by an arbitrary laboratory value. In the critical care setting, liberal use of transfusions to maintain near-normal levels of hemoglobin may have

unexpected negative effects on survival. In most patients requiring transfusion, levels of hemoglobin of 100 g/L are sufficient to keep oxygen supply from being critically low.

PRBCs may be modified to prevent certain adverse reactions. Leukocyte reduction of cellular blood products is increasingly common, and universal prestorage leukocyte reduction has been recommended. Prestorage filtration appears superior to bedside filtration because smaller amounts of cytokines are generated in the stored product. These PRBC units contain  $<5 \times 10^6$  donor white blood cells (WBCs), and their use lowers the incidence of posttransfusion fever, cytomegalovirus (CMV) infections, and alloimmunization. Other theoretical benefits include less immunosuppression in the recipient and lower risk of infections. Plasma, which may cause allergic reactions, can be removed from cellular blood components by washing.

## PLATELETS

Thrombocytopenia is a risk factor for hemorrhage, and platelet transfusion reduces the incidence of bleeding. The threshold for prophylactic platelet transfusion is 10,000/ $\mu$ L. In patients without fever or infections, a threshold of 5000/ $\mu$ L may be sufficient to prevent spontaneous hemorrhage. For invasive procedures, 50,000/ $\mu$ L platelets is the usual target level.

Platelets are given either as pools prepared from five to eight RDs or as SDAPs from a single donor. In an unsensitized patient without increased platelet consumption [splenomegaly, fever, disseminated intravascular coagulation (DIC)], 6–8 units of RD platelets (~1 unit per 10 kg body weight) are transfused, and each unit is anticipated to increase the platelet count 5000–10,000/ $\mu$ L. Patients who have received multiple transfusions may be alloimmunized to many HLA- and platelet-specific antigens and have

little or no increase in their posttransfusion platelet counts. Patients who may require multiple transfusions are best served by receiving SDAP and leukocyte-reduced components to lower the risk of alloimmunization.

Refractoriness to platelet transfusion may be evaluated using the corrected count increment (CCI):

$$\text{CCI} = \frac{\text{posttransfusion count} - \text{pretransfusion count}}{\text{Number of platelets transfused} \times 10^{11}} \times \text{BSA}$$

where BSA is body surface area measured in square meters. The platelet count performed 1 hour after the transfusion is acceptable if the CCI is  $10 \times 10^9/\text{mL}$ , and after 18–24 h an increment of  $7.5 \times 10^9/\text{mL}$  is expected. Patients who have suboptimal responses are likely to have received multiple transfusions and have antibodies directed against class I HLA antigens. Refractoriness can be investigated by detecting anti-HLA antibodies in the recipient's serum. Patients who are sensitized will often react with 100% of the lymphocytes used for the HLA-antibody screen, and HLA-matched SDAPs should be considered for those patients who require transfusion. Although ABO-identical HLA-matched SDAPs provide the best chance for increasing the platelet count, locating these products is difficult. Platelet cross-matching is available in some centers. Additional clinical causes for a low platelet CCI include fever, bleeding, splenomegaly, DIC, or medications in the recipient.

## FRESH-FROZEN PLASMA

FFP contains stable coagulation factors and plasma proteins: fibrinogen, antithrombin, albumin, as well as proteins C and S. Indications for FFP include correction of coagulopathies, including the rapid reversal of warfarin; supplying deficient plasma proteins; and treatment of thrombotic thrombocytopenic purpura. FFP should not be routinely used to expand blood volume. FFP is an acellular component and does not transmit intracellular infections, e.g., CMV. Patients who are IgA-deficient and require plasma support should receive FFP from IgA-deficient donors to prevent anaphylaxis (see later).

## CRYOPRECIPITATE

Cryoprecipitate is a source of fibrinogen, factor VIII, and von Willebrand's factor (vWF). It is ideal for supplying fibrinogen to the volume-sensitive patient. When factor VIII concentrates are not available, cryoprecipitate may be used because each unit contains approximately 80 units of factor VIII. Cryoprecipitate may also supply vWF to patients with dysfunctional (type II) or absent (type III) von Willebrand's disease.

Plasma from thousands of donors may be pooled to derive specific protein concentrates, including albumin, intravenous immunoglobulin, antithrombin, and coagulation factors. In addition, donors who have high-titer antibodies to specific agents or antigens provide hyperimmune globulins, such as anti-D (RhoGam, WinRho), and antisera to hepatitis B virus (HBV), varicella-zoster virus, CMV, and other infectious agents.

## ADVERSE REACTIONS TO BLOOD TRANSFUSION

Adverse reactions to transfused blood components occur despite multiple tests, inspections, and checks. Fortunately, the most common reactions are not life-threatening, although serious reactions can present with mild symptoms and signs. Some reactions can be reduced or prevented by modified (filtered, washed, or irradiated) blood components. When an adverse reaction is suspected, the transfusion should be stopped and reported to the blood bank for investigation.

Transfusion reactions may result from immune and nonimmune mechanisms. Immune-mediated reactions are often due to preformed donor or recipient antibody; however, cellular elements may also cause adverse effects. Nonimmune causes of reactions are due to the chemical and physical properties of the stored blood component and its additives.

Transfusion-transmitted viral infections are increasingly rare due to improved screening and testing. As the risk of viral infection is reduced, the relative risk of other reactions increases, such as hemolytic transfusion reactions and sepsis from bacterially contaminated components. More effort is being directed at improving pretransfusion quality assurance to further increase the safety of transfusion therapy. Infections, like any adverse transfusion reaction, must be brought to the attention of the blood bank for appropriate studies (Table 12-3).

## IMMUNE-MEDIATED REACTIONS

### *Acute Hemolytic Transfusion Reactions*

Immune-mediated hemolysis occurs when the recipient has preformed antibodies that lyse donor erythrocytes. The ABO isoagglutinins are responsible for most of these reactions, although alloantibodies directed against other RBC antigens, i.e., Rh, Kell, and Duffy, may result in hemolysis.

Acute hemolytic reactions may present with hypotension, tachypnea, tachycardia, fever, chills, hemoglobinemia, hemoglobinuria, chest and/or flank pain, and discomfort at the infusion site. Monitoring the patient's vital signs before and during the transfusion is important to identify reactions promptly. When acute hemolysis is suspected,

**RISKS OF TRANSFUSION COMPLICATIONS**

FREQUENCY, EPISODES:UNIT

Reactions	
Febrile (FNHTR)	1–4:100
Allergic	1–4:100
Delayed hemolytic	1:1000
TRALI	1:5000
Acute hemolytic	1:12,000
Fatal hemolytic	1:100,000
Anaphylactic	1:150,000
Infections <sup>a</sup>	
Hepatitis B	1:63,000
Hepatitis C	1:1,600,000
HIV-1	1:1,960,000
HIV-2	None reported
HTLV-I and -II	1:641,000
Malaria	1:4,000,000
Other complications	
RBC allosensitization	1:100
HLA allosensitization	1:10
Graft-versus-host disease	Rare

<sup>a</sup>Infectious agents rarely associated with transfusion, theoretically possible or of unknown risk, include Hepatitis A virus, parvovirus B-19, *Babesia microti* (babesiosis), *Borrelia burgdorferi* (Lyme disease), *Trypanosoma cruzi* (Chagas' disease), and *Treponema pallidum*, human herpesvirus-8 and hepatitis G virus.

**Note:** FNHTR, febrile nonhemolytic transfusion reaction; TRALI, transfusion-related acute lung injury; HTLV, human T lymphotropic virus; RBC, red blood cell.

the transfusion must be stopped immediately, intravenous access maintained, and the reaction reported to the blood bank. A correctly labeled posttransfusion blood sample and any untransfused blood should be sent to the blood bank for analysis. The laboratory evaluation for hemolysis includes the measurement of serum haptoglobin, lactate dehydrogenase (LDH), and indirect bilirubin levels.

The immune complexes that result in RBC lysis can cause renal dysfunction and failure. Diuresis should be induced with intravenous fluids and furosemide or mannitol. Tissue factor released from the lysed erythrocytes may initiate DIC. Coagulation studies including prothrombin time (PT), activated partial thromboplastin time (aPTT), fibrinogen, and platelet count should be monitored in patients with hemolytic reactions.

Errors at the patient's bedside, such as mislabeling the sample or transfusing the wrong patient, are responsible for most of these reactions. The blood bank investigation of these reactions includes examination of the pre- and posttransfusion samples for hemolysis and repeat typing of the patient samples; direct antiglobulin test (DAT), sometimes called the *direct Coombs test*, of the posttransfusion sample; repeating the cross-matching of the blood component; and checking all clerical records for errors.

DAT detects the presence of antibody or complement bound to RBCs in vivo.

### **Delayed Hemolytic and Serologic Transfusion Reactions**

Delayed hemolytic transfusion reactions (DHTRs) are not completely preventable. These reactions occur in patients previously sensitized to RBC alloantigens who have a negative alloantibody screen due to low antibody levels. When the patient is transfused with antigen-positive blood, an anamnestic response results in the early production of alloantibody that binds donor RBCs. The alloantibody is detectable 1–2 weeks following the transfusion, and the posttransfusion DAT may become positive due to circulating donor RBCs coated with antibody or complement. The transfused, alloantibody-coated erythrocytes are cleared by the reticuloendothelial system. These reactions are detected most commonly in the blood bank when a subsequent patient sample reveals a positive alloantibody screen or a new alloantibody in a recently transfused recipient.

No specific therapy is usually required, although additional RBC transfusions may be necessary. Delayed serologic transfusion reactions are similar to DHTR because the DAT is positive and alloantibody is detected; however, RBC clearance is not increased.

### **Febrile Nonhemolytic Transfusion Reaction**

The most frequent reaction associated with the transfusion of cellular blood components is a febrile nonhemolytic transfusion reaction (FNHTR). These reactions are characterized by chills and rigors and a  $\geq 1^\circ\text{C}$  rise in temperature. FNHTR is diagnosed when other causes of fever in the transfused patient are ruled out. Antibodies directed against donor leukocyte and HLA antigens may mediate these reactions; thus multiply transfused patients and multiparous women are believed to be at increased risk. Although antibodies may be demonstrated in the recipient's serum, investigation is not routinely done because of the mild nature of most FNHTR. The use of leukocyte-reduced blood products may prevent or delay sensitization to leukocyte antigens and thereby reduce the incidence of these febrile episodes. Cytokines released from cells within stored blood components may mediate FNHTR; thus leukoreduction before storage may prevent these reactions. The incidence and severity of these reactions can be decreased in patients with recurrent reactions by premedicating with acetaminophen or other antipyretic agents.

### **Allergic Reactions**

Urticarial reactions are related to plasma proteins found in transfused components. Mild reactions may be treated symptomatically by temporarily stopping the transfusion

and administering antihistamines (diphenhydramine, 50 mg orally or intramuscularly). The transfusion may be completed after the signs and/or symptoms resolve. Patients with a history of allergic transfusion reaction should be premedicated with an antihistamine. Cellular components can be washed to remove residual plasma for the extremely sensitized patient.

### **Anaphylactic Reaction**

This severe reaction presents after transfusion of only a few milliliters of the blood component. Symptoms and signs include difficulty breathing, coughing, nausea and vomiting, hypotension, bronchospasm, loss of consciousness, respiratory arrest, and shock. Treatment includes stopping the transfusion, maintaining vascular access, and administering epinephrine (0.5–1.0 mL of 1:1000 dilution subcutaneously). Glucocorticoids may be required in severe cases.

Patients who are IgA-deficient, <1% of the population, may be sensitized to this Ig class and are at risk for anaphylactic reactions associated with plasma transfusion. Individuals with severe IgA deficiency should therefore receive only IgA-deficient plasma and washed cellular blood components. Patients who have anaphylactic or repeated allergic reactions to blood components should be tested for IgA deficiency.

### **Graft-versus-Host Disease**

Graft-versus-host disease (GVHD) is a frequent complication of allogeneic stem cell transplantation, in which lymphocytes from the donor attack and cannot be eliminated by an immunodeficient host. Transfusion-related GVHD is mediated by donor T lymphocytes that recognize host HLA antigens as foreign and mount an immune response, which is manifested clinically by the development of fever, a characteristic cutaneous eruption, diarrhea, and liver function abnormalities. GVHD can also occur when blood components that contain viable T lymphocytes are transfused to immunodeficient recipients or to immunocompetent recipients who share HLA antigens with the donor (e.g., a family donor). In addition to the previously mentioned clinical features of GVHD, transfusion-associated GVHD (TA-GVHD) is characterized by marrow aplasia and pancytopenia. TA-GVHD is highly resistant to treatment with immunosuppressive therapies, including glucocorticoids, cyclosporine, antithymocyte globulin, and ablative therapy followed by allogeneic bone marrow transplantation. Clinical manifestations appear at 8–10 days, and death occurs at 3–4 weeks posttransfusion.

TA-GVHD can be prevented by irradiation of cellular components (minimum of 2500 cGy) before transfusion to patients at risk. Patients at risk for TA-GVHD include fetuses receiving intrauterine transfusions, selected immunocompetent (e.g., lymphoma patients) or

immunocompromised recipients, recipients of donor units known to be from a blood relative, and recipients who have undergone marrow transplantation. Directed donations by family members should be discouraged (they are not less likely to transmit infection); lacking other options, the blood products from family members should always be irradiated.

### **Transfusion-Related Acute Lung Injury**

This uncommon reaction results from the transfusion of donor plasma that contains high-titer anti-HLA antibodies that bind recipient leukocytes. The leukocytes aggregate in the pulmonary vasculature and release mediators that increase capillary permeability. The recipient develops symptoms of respiratory compromise and signs of noncardiogenic pulmonary edema, including bilateral interstitial infiltrates on chest x-ray. Treatment is supportive, and patients usually recover without sequelae. Testing the donor's plasma for anti-HLA antibodies can support this diagnosis. The implicated donors are frequently multiparous women, and transfusion of their plasma component should be avoided.

### **Posttransfusion Purpura**

This reaction presents as thrombocytopenia 7–10 days after platelet transfusion and occurs predominantly in women. Platelet-specific antibodies are found in the recipient's serum, and the most frequently recognized antigen is HPA-1a found on the platelet glycoprotein IIIa receptor. The delayed thrombocytopenia is due to the production of antibodies that react to both donor and recipient platelets. Additional platelet transfusions can worsen the thrombocytopenia and should be avoided. Treatment with intravenous immunoglobulin may neutralize the effector antibodies, or plasmapheresis can be used to remove the antibodies.

### **Alloimmunization**

A recipient may become alloimmunized to a number of antigens on cellular blood elements and plasma proteins. Alloantibodies to RBC antigens are detected during pretransfusion testing, and their presence may delay finding antigen-negative cross-match-compatible products for transfusion. Women of childbearing age who are sensitized to certain RBC antigens (i.e., D, c, E, Kell, or Duffy) are at risk for bearing a fetus with hemolytic disease of the newborn. Matching for D antigen is the only pretransfusion selection test to prevent RBC alloimmunization.

Alloimmunization to antigens on leukocytes and platelets can result in refractoriness to platelet transfusions. Once alloimmunization has developed, HLA-compatible platelets from donors who share similar antigens with the recipient may be difficult to find. Hence

150 prudent transfusion practice is directed at preventing sensitization through the use of leukocyte-reduced cellular components, as well as limiting antigenic exposure by the judicious use of transfusions and use of SDAPs.

## NONIMMUNOLOGIC REACTIONS

### Fluid Overload

Blood components are excellent volume expanders, and transfusion may quickly lead to volume overload. Monitoring the rate and volume of the transfusion and using a diuretic can minimize this problem.

### Hypothermia

Refrigerated (4°C) or frozen (−18°C or below) blood components can result in hypothermia when rapidly infused. Cardiac dysrhythmias can result from exposing the sinoatrial node to cold fluid. Use of an inline warmer will prevent this complication.

### Electrolyte Toxicity

RBC leakage during storage increases the concentration of potassium in the unit. Neonates and patients in renal failure are at risk for hyperkalemia. Preventive measures, such as using fresh or washed RBCs, are warranted for neonatal transfusions because this complication can be fatal.

Citrate, commonly used to anticoagulate blood components, chelates calcium and thereby inhibits the coagulation cascade. Hypocalcemia, manifested by circumoral numbness and/or tingling sensation of the fingers and toes, may result from multiple rapid transfusions. Because citrate is quickly metabolized to bicarbonate, calcium infusion is seldom required in this setting. If calcium or any other intravenous infusion is necessary, it must be given through a separate line.

### Iron Overload

Each unit of RBCs contains 200–250 mg of iron. Symptoms and signs of iron overload affecting endocrine, hepatic, and cardiac function are common after 100 units of RBCs have been transfused (total-body iron load of 20 g). Preventing this complication by using alternative therapies (e.g., erythropoietin) and judicious transfusion is preferable and cost effective. Deferoxamine and other chelating agents are available, but the response is often suboptimal.

### Hypotensive Reactions

Transient hypotension may be noted among transfused patients who take angiotensin-converting enzyme (ACE) inhibitors. Because blood products contain bradykinin that is normally degraded by ACE, patients on ACE

inhibitors may have increased bradykinin levels that cause hypotension. The blood pressure typically returns to normal without intervention.

### Immunomodulation

Transfusion of allogeneic blood is immunosuppressive. Multiply transfused renal transplant recipients are less likely to reject the graft, and transfusion may result in poorer outcomes in cancer patients and increase the risk of infections. Transfusion-related immunomodulation is thought to be mediated by transfused leukocytes. Leukocyte-depleted cellular products may cause less immunosuppression, although controlled data have not been obtained and are unlikely to be obtained as the blood supply becomes universally leukocyte-depleted.

## INFECTIOUS COMPLICATIONS

Nucleic acid amplification testing (NAT) began in 1999 to screen donated blood for the presence of HIV and hepatitis C virus (HCV) RNA. Since 2003 NAT has been used to detect West Nile virus (WNV) RNA in donated blood.

### Viral Infections

#### Hepatitis C Virus

Blood donations are tested for antibodies to HCV and HCV RNA. Fewer than 200 HCV RNA-positive, antibody-negative donors have been found. The risk of acquiring HCV through transfusion is now calculated to be approximately 1 in 2 million units. Infection with HCV may be asymptomatic or lead to chronic active hepatitis, cirrhosis, and liver failure.

#### Human Immunodeficiency Virus Type 1

Donated blood is tested for antibodies to HIV-1, HIV-1 p24 antigen, and HIV RNA using NAT. Approximately a dozen seronegative donors have been shown to harbor HIV RNA. The risk of HIV-1 infection per transfusion episode is 1 in 2 million. Antibodies to HIV-2 are also measured in donated blood. No cases of HIV-2 infection have been reported in the United States since 1992.

#### Hepatitis B Virus

Donated blood is screened for HBV using assays for hepatitis B surface antigen (HbsAg). NAT testing is not practical because of slow viral replication and lower levels of viremia. The risk of transfusion-associated HBV infection is 1 in 63,000 units, twentyfold greater than for HCV. Vaccination of individuals who require long-term transfusion therapy can prevent this complication.

#### Other Hepatitis Viruses

Hepatitis A virus is rarely transmitted by transfusion; infection is typically asymptomatic and does not lead to

chronic disease. Other transfusion-transmitted viruses—TTV, SEN-V, and GBV-C—do not cause chronic hepatitis or other disease states. Routine testing does not appear to be warranted.

### West Nile Virus

Transfusion-transmitted WNV infections were documented in 2002. This RNA virus can be detected using NAT; routine screening began in 2003, and >1000 blood donors have tested positive. WNV infections range in severity from asymptomatic to fatal, with the older population at greater risk.

### Cytomegalovirus

This ubiquitous virus infects  $\geq 50\%$  of the general population and is transmitted by the infected “passenger” WBCs found in transfused PRBCs or platelet components. Cellular components that are leukocyte-reduced have a decreased risk of transmitting CMV, regardless of the serologic status of the donor. Groups at risk for CMV infections include immunosuppressed patients, CMV-seronegative transplant recipients, and neonates; these patients should receive leukocyte-depleted components or CMV seronegative products.

### Human T Lymphotropic Virus (HTLV) Type I

Assays to detect HTLV-I and -II are used to screen all donated blood. HTLV-I is associated with adult T cell leukemia/lymphoma and tropical spastic paraparesis in a small percentage of infected persons. The risk of HTLV-I infection via transfusion is 1 in 641,000 transfusion episodes. HTLV-II is not clearly associated with any disease.

### Parvovirus B-19

Blood components and pooled plasma products can transmit this virus, the etiologic agent of erythema infectiosum, or fifth disease, in children. Parvovirus B-19 shows tropism for erythroid precursors and inhibits both erythrocyte production and maturation. Pure red cell aplasia, presenting either as acute aplastic crisis or chronic anemia with shortened RBC survival, may occur in individuals with an underlying hematologic disease, such as sickle cell disease or thalassemia (Chap. 11). The fetus of a seronegative woman is at risk for developing hydrops from this virus.

## Bacterial Contamination

The relative risk of transfusion-transmitted bacterial infection has increased as the absolute risk of viral infections has dramatically decreased.

Most bacteria do not grow well at cold temperatures; thus PRBCs and FFP are not common sources of bacterial contamination. However, some gram-negative bacteria can grow at 1–6°C. *Yersinia*, *Pseudomonas*, *Serratia*,

*Acinetobacter*, and *Escherichia* species have all been implicated in infections related to PRBC transfusion. Platelet concentrates, which are stored at room temperature, are more likely to contain skin contaminants such as gram-positive organisms, including coagulase-negative staphylococci. It is estimated that 1 in 1000–2000 platelet components is contaminated with bacteria. The risk of death due to transfusion-associated sepsis has been calculated at 1 in 17,000 for single-unit platelets derived from whole blood donation and 1 in 61,000 for apheresis product. Since 2004, blood banks have instituted methods to detect contaminated platelet components.

Recipients of transfusion contaminated with bacteria may develop fever and chills, which can progress to septic shock and DIC. These reactions may occur abruptly, within minutes of initiating the transfusion, or after several hours. The onset of symptoms and signs is often sudden and fulminant, which distinguishes bacterial contamination from an FNHTR. The reactions, particularly those related to gram-negative contaminants, are the result of infused endotoxins formed within the contaminated stored component.

When these reactions are suspected, the transfusion must be stopped immediately. Therapy is directed at reversing any signs of shock, and broad-spectrum antibiotics should be given. The blood bank should be notified to identify any clerical or serologic error. The blood component bag should be sent for culture and Gram stain.

## Other Infectious Agents

Various parasites, including those causing malaria, babesiosis, and Chagas’ disease, can be transmitted by blood transfusion. Geographic migration and travel of donors shift the incidence of these rare infections. Other agents implicated in transfusion transmission include Lyme disease and variant Creutzfeldt-Jakob disease. These infections should be considered in the transfused patient in the appropriate clinical setting.

## ALTERNATIVES TO TRANSFUSION

Alternatives to allogeneic blood transfusions that avoid homologous donor exposures with attendant immunologic and infectious risks remain attractive. Autologous blood is the best option when transfusion is anticipated. However, the cost-benefit ratio of autologous transfusion remains high. No transfusion is a zero-risk event; clerical errors and bacterial contamination remain potential complications even with autologous transfusions. Additional methods of autologous transfusion in the surgical patient include preoperative hemodilution, recovery of shed blood from sterile surgical sites, and postoperative drainage collection. Directed or designated donation from friends and family of the potential



152 recipient has not been safer than volunteer donor component transfusions. Such directed donations may in fact place the recipient at higher risk for complications such as GVHD and alloimmunization.

Granulocyte and granulocyte-macrophage colony-stimulating factor are clinically useful to hasten leukocyte recovery in patients with leukopenia related to high-dose chemotherapy. Erythropoietin stimulates erythrocyte production in patients with anemia of chronic renal failure and other conditions, thus avoiding or reducing the need for transfusion. This hormone can also stimulate erythropoiesis in the autologous donor to enable additional donation.

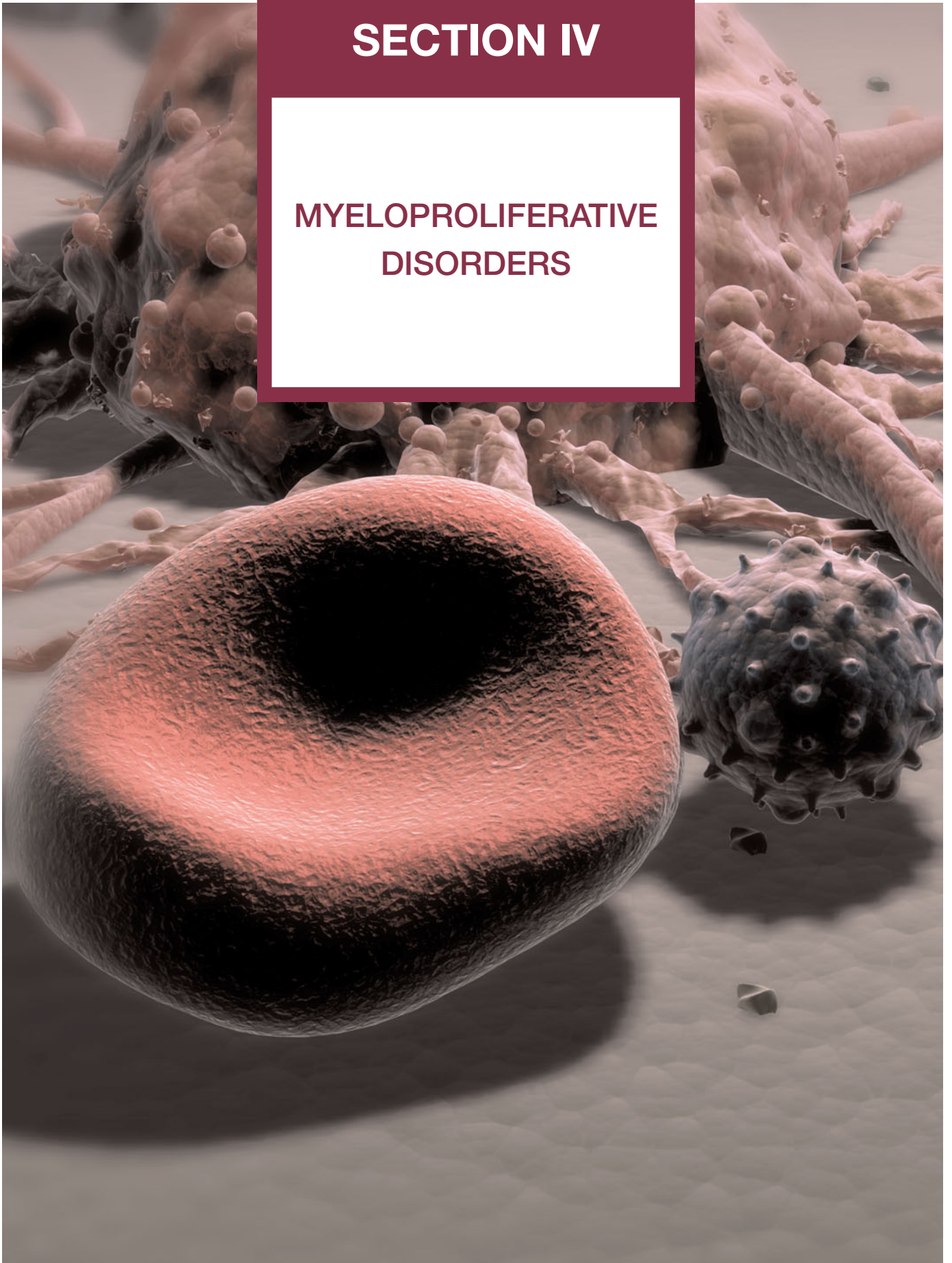
### FURTHER READINGS

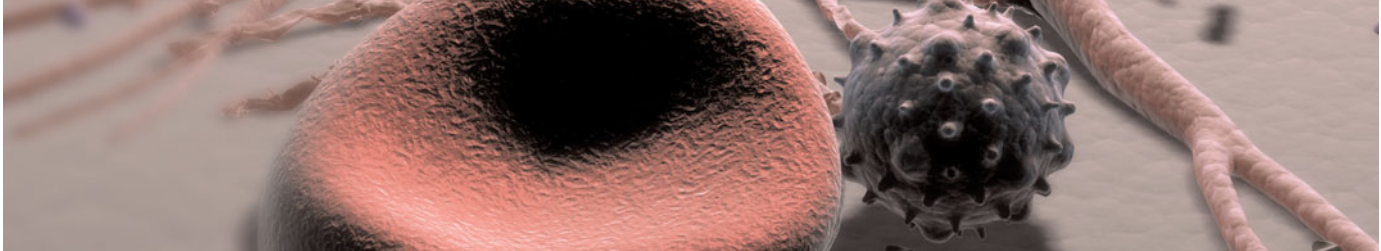
- ANSTEE DJ: Red cell genotyping and the future of pretransfusion testing. *Blood* 114:248, 2009
- BLAJCHMAN MA: The clinical benefits of the leukoreduction of blood products. *J Trauma* 60:S83, 2006

- BRECHER ME (ed): *The Technical Manual*, 15th ed. Arlington, VA, American Association of Blood Banks, 2005
- BRECHER ME, Hay SN: Bacterial contamination of blood components. *Clin Micro Rev* 18:195, 2005
- BUSCH MP et al: A new strategy for estimating risks of transfusion transmitted viral infections based on rates of detection of recently infected donors. *Transfusion* 45:254, 2005
- HEARNshaw S et al: Red cell transfusion for the management of upper gastrointestinal haemorrhage. *Cochrane Database Syst Rev* CD006613, 2009
- RAGHAVANA M, Marik PE: Anemia, allogeneic blood transfusion, and immunomodulation in the critically ill. *Chest* 127:295, 2005
- SHAZ BH et al: Transfusion management of trauma patients. *Anesth Analg* 108:1760, 2009
- SHEPPARD CA et al: Transfusion-related acute lung injury. *Hematol Oncol Clin North Am* 21:163, 2007
- WEBSTER J et al: Skin preparation with alcohol versus alcohol followed by any antiseptic for preventing bacteraemia or contamination of blood for transfusion. *Cochrane Database Syst Rev* CD007948, 2009

# SECTION IV

## MYELOPROLIFERATIVE DISORDERS





## CHAPTER 13

# POLYCYTHEMIA VERA AND OTHER MYELOPROLIFERATIVE DISEASES

Jerry L. Spivak

■ Polycythemia Vera . . . . .	155	Diagnosis . . . . .	159
Etiology . . . . .	155	Complications . . . . .	159
Clinical Features . . . . .	155	■ Essential Thrombocytosis . . . . .	161
Diagnosis . . . . .	156	Etiology . . . . .	161
Complications . . . . .	156	Clinical Features . . . . .	161
■ Chronic Idiopathic Myelofibrosis . . . . .	158	Diagnosis . . . . .	162
Etiology . . . . .	158	Complications . . . . .	162
Clinical Features . . . . .	158	■ Further Readings . . . . .	163

The World Health Organization (WHO) classification of the chronic myeloproliferative diseases includes seven disorders, some of which are rare or poorly characterized (**Table 13-1**) but all of which share an origin in a multipotent hematopoietic progenitor cell, overproduction of one or more of the formed elements of the blood without significant dysplasia, a predilection to extramedullary hematopoiesis, myelofibrosis, and transformation at varying rates to acute leukemia. Within this broad classification, however, significant phenotypic heterogeneity exists. Some diseases, such as chronic myelogenous leukemia (CML), chronic neutrophilic leukemia (CNL), and chronic eosinophilic leukemia (CEL), express primarily a myeloid phenotype; in others, such as polycythemia vera (PV), idiopathic myelofibrosis (IMF), and essential thrombocytosis (ET), erythroid or megakaryocytic hyperplasia predominates. The latter three disorders, in contrast to the former three, also appear capable of transforming into each other.

This phenotypic heterogeneity has a genetic basis; CML is the consequence of the balanced translocation between chromosomes 9 and 22 [t(9;22)(q34;11)]; CNL has been associated with a t(15;19) translocation, and CEL with a deletion or balanced translocations involving the PDGFR $\alpha$  gene. By contrast, to a greater or lesser extent, PV, IMF, and ET are characterized by expression

of a JAK2 mutation, V617F, which causes constitutive activation of this tyrosine kinase that is essential for the function of the erythropoietin and thrombopoietin receptors but not the granulocyte colony-stimulating factor receptor. This essential distinction is also reflected in the natural history of CML, CNL, and CEL, which is usually measured in years, and their high rate of transformation into acute leukemia. By contrast, the natural history of PV, IMF, and ET is usually measured in decades, and transformation to acute leukemia is uncommon in

**TABLE 13-1**

### WHO CLASSIFICATION OF CHRONIC MYELOPROLIFERATIVE DISORDERS

- Chronic myelogenous leukemia, [Ph chromosome t(9;22)(q34;11), BCR/ABL-positive]
- Chronic neutrophilic leukemia
- Chronic eosinophilic leukemia (and the hypereosinophilic syndrome)
- Polycythemia vera
- Chronic idiopathic myelofibrosis (with extramedullary hematopoiesis)
- Essential thrombocythemia
- Chronic myeloproliferative disease, unclassifiable

the absence of exposure to mutagenic agents. This chapter, therefore, focuses only on PV, IMF, and ET because their clinical overlap is substantial and their clinical courses are distinctly different.

Other chronic myeloproliferative disorders are discussed in Chap. 14.

## POLYCYTHEMIA VERA

Polycythemia vera (PV) is a clonal disorder involving a multipotent hematopoietic progenitor cell in which phenotypically normal red cells, granulocytes, and platelets accumulate in the absence of a recognizable physiologic stimulus. The most common of the chronic myeloproliferative disorders, PV occurs in 2 per 100,000 persons, sparing no adult age group and increasing with age to rates as high as 18/100,000. Familial transmission occurs but is infrequent. A slight overall male predominance has been observed, but women predominate within the reproductive age range.

### ETIOLOGY

The etiology of PV is unknown. Although nonrandom chromosome abnormalities such as 20q, trisomy 8, and especially 9p have been documented in up to 30% of untreated PV patients, unlike CML no consistent cytogenetic abnormality has been associated with the disorder. However, a mutation in the autoinhibitory, pseudokinase domain of the tyrosine kinase JAK2—which replaces valine with phenylalanine (V617F), causing constitutive activation of the kinase—appears to have a central role in the pathogenesis of PV.

JAK2 is a member of an evolutionarily well-conserved, nonreceptor tyrosine kinase family and serves as the cognate tyrosine kinase for the erythropoietin and thrombopoietin receptors. It also functions as an obligate chaperone for these receptors in the Golgi apparatus and is responsible for their cell-surface expression. The conformational change induced in the erythropoietin and thrombopoietin receptors following binding to erythropoietin or thrombopoietin leads to JAK2 autophosphorylation, receptor phosphorylation, and phosphorylation of proteins involved in cell proliferation, differentiation, and resistance to apoptosis. Transgenic animals lacking JAK2 die as embryos from severe anemia. Constitutive activation of JAK2 can explain the erythropoietin-independent erythroid colony formation, and the hypersensitivity of PV erythroid progenitor cells to erythropoietin and other hematopoietic growth factors, their resistance to apoptosis *in vitro* in the absence of erythropoietin, their rapid terminal differentiation, and their increase in Bcl-X<sub>L</sub> expression, all of which are characteristic in PV.

Importantly, the JAK2 gene is located on the short arm of chromosome 9, and loss of heterozygosity on

chromosome 9p, due to uniparental disomy is the most common cytogenetic abnormality in PV. The segment of 9p involved contains the JAK2 locus; loss of heterozygosity in this region leads to homozygosity for the mutant JAK2 V617F. Over 90% of PV patients express this mutation, as do ~45% of IMF and ET patients. Homozygosity for the mutation occurs in ~30% of PV patients and 60% of IMF patients; homozygosity is rare in ET. Over time, a portion of PV JAK2 V617F heterozygotes become homozygotes, but usually not after 10 years of the disease. PV patients who do not express JAK2 V617F are not clinically different than those who do, nor do JAK2 V617F heterozygotes differ clinically from homozygotes. In general, patients who express JAK2 V617F are older than those who do not, but they do not have a longer duration of disease.

JAK2 V617F is the basis for many of the phenotypic and biochemical characteristics of PV, such as elevation of the leukocyte alkaline phosphatase (LAP) score and increased expression of the mRNA of PVR-1, a glycosylphosphatidylinositol (GPI)-linked membrane protein; however, it cannot solely account for the entire PV phenotype. First, PV patients with the same phenotype and documented clonal disease lack this mutation. Second, IMF patients have the same mutation but a different clinical phenotype. Third, familial PV can occur without the mutation, even when other members of the same family express it. Fourth, not all the cells of the malignant clone express JAK2 V617F. Fifth, JAK2 V617F has been observed in patients with long-standing idiopathic erythrocytosis. However, although JAK2 V617F alone may not be sufficient to cause PV, it is essential for the transformation of ET to PV, though not for its transformation to IMF.

### CLINICAL FEATURES

Although splenomegaly may be the initial presenting sign in PV, most often the disorder is first recognized by the incidental discovery of a high hemoglobin or hematocrit. With the exception of aquagenic pruritus, no symptoms distinguish PV from other causes of erythrocytosis.

Uncontrolled erythrocytosis causes hyperviscosity, leading to neurologic symptoms such as vertigo, tinnitus, headache, visual disturbances, and transient ischemic attacks (TIAs). Systolic hypertension is also a feature of the red cell mass elevation. In some patients, venous or arterial thrombosis may be the presenting manifestation of PV. Any vessel can be affected, but cerebral, cardiac, or mesenteric vessels are most commonly involved. Intraabdominal venous thrombosis is particularly common in young women and may be catastrophic if a sudden and complete obstruction of the hepatic vein occurs. Indeed, PV should be suspected in any patient who develops hepatic vein thrombosis. Digital ischemia, easy bruising, epistaxis, acid-peptic disease, or gastrointestinal hemorrhage may occur

156 due to vascular stasis or thrombocytosis. Erythema, burning, and pain in the extremities, a symptom complex known as erythromelalgia, is another complication of the thrombocytosis of PV. Given the large turnover of hematopoietic cells, hyperuricemia with secondary gout, uric acid stones, and symptoms due to hypermetabolism can also complicate the disorder.

The plasma erythropoietin level is a useful diagnostic test in patients with isolated erythrocytosis because an elevated level excludes PV as the cause for the erythrocytosis.

## DIAGNOSIS

When PV presents with erythrocytosis in combination with leukocytosis, thrombocytosis, or both, the diagnosis is apparent. However, when patients present with an elevated hemoglobin or hematocrit alone, or with thrombocytosis alone, the diagnostic evaluation is more complex because of the many diagnostic possibilities (Table 13-2). Furthermore, unless the hemoglobin level is  $\geq 20$  gm% (hematocrit  $\geq 60\%$ ), it is not possible to distinguish PV from disorders causing plasma volume

contraction. Uniquely in PV, an expanded plasma volume can mask an elevated red cell mass; thus red cell mass and plasma volume determinations are mandatory to establish the presence of an absolute erythrocytosis and to distinguish this from relative erythrocytosis due to a reduction in plasma volume alone (also known as *stress* or *spurious erythrocytosis* or *Gaisböck's syndrome*). This is true even in with the discovery of the JAK2 V617F mutation because not every patient with PV expresses this mutation, whereas patients without PV do. Figure 2-18 illustrates a diagnostic algorithm for the evaluation of suspected erythrocytosis.

Once absolute erythrocytosis has been established, its cause must be determined. An elevated plasma erythropoietin level suggests either a hypoxic cause for erythrocytosis or autonomous erythropoietin production, in which case assessment of pulmonary function and an abdominal CT scan to evaluate renal and hepatic anatomy are appropriate. A normal erythropoietin level does not exclude a hypoxic cause for erythrocytosis. In PV, in contrast to hypoxic erythrocytosis, the arterial oxygen saturation is normal. However, a normal oxygen saturation does not exclude a high-affinity hemoglobin as a cause for erythrocytosis; documentation of previous hemoglobin levels and a family study are important.

Other laboratory studies that may aid in diagnosis include the red cell count, mean corpuscular volume, and red cell distribution width (RDW). Only three situations cause microcytic erythrocytosis:  $\beta$ -thalassemia trait, hypoxic erythrocytosis, and PV. With  $\beta$ -thalassemia trait the RDW is normal, whereas with hypoxic erythrocytosis and PV, the RDW is usually elevated due to iron deficiency. In many patients, the LAP level is also increased, as is the uric acid level. Elevated serum vitamin B<sub>12</sub> or B<sub>12</sub>-binding capacity may be present. In patients with associated acid-peptic disease, occult gastrointestinal bleeding may lead to presentation with hypochromic, microcytic anemia.

A bone marrow aspirate and biopsy provide no specific diagnostic information because these may be normal or indistinguishable from ET or IMF, and unless there is a need to establish the presence of myelofibrosis or exclude some other disorder, these procedures need not be done. Although the presence of a cytogenetic abnormality such as trisomy 8 or 9 or 20q- in the setting of an expanded red cell mass supports a clonal etiology, no specific cytogenetic abnormality is associated with PV, and the absence of a cytogenetic marker does not exclude the diagnosis.

## COMPLICATIONS

The major clinical complications of PV relate directly to the increase in blood viscosity associated with red cell mass elevation and indirectly to the increased turnover of red cells, leukocytes, and platelets with the attendant

TABLE 13-2

### CAUSES OF ERYTHROCYTOSIS

#### Relative erythrocytosis

Hemoconcentration secondary to dehydration, androgens, or tobacco abuse

#### Absolute erythrocytosis

##### Hypoxia

- Carbon monoxide intoxication
- High-affinity hemoglobin
- High altitude
- Pulmonary disease
- Right-to-left shunts
- Sleep-apnea syndrome
- Neurologic disease

##### Renal disease

- Renal artery stenosis
- Focal sclerosing or membranous glomerulonephritis
- Renal transplantation

##### Tumors

- Hypernephroma
- Hepatoma
- Cerebellar hemangioblastoma
- Uterine fibromyoma
- Adrenal tumors
- Meningioma
- Pheochromocytoma

##### Drugs

- Androgens
- Recombinant erythropoietin

*Familial* (with normal hemoglobin function, Chuvash, erythropoietin receptor mutations)

*Polycythemia vera*

increase in uric acid and cytokine production. The latter appears to be responsible for the increase in peptic ulcer disease and for the pruritus associated with this disorder, although formal proof for this has not been obtained. A sudden massive increase in spleen size can be associated with splenic infarction or progressive cachexia. Myelofibrosis appears to be part of the natural history of the disease but is a reactive, reversible process that does not itself impede hematopoiesis and by itself has no prognostic significance. In some patients, however, the myelofibrosis is accompanied by significant extramedullary hematopoiesis, hepatosplenomegaly, and transfusion-dependent anemia. The organomegaly can cause significant mechanical discomfort, portal hypertension, and cachexia. Although the incidence of acute nonlymphocytic leukemia is increased in PV, the incidence of acute leukemia in patients not exposed to chemotherapy or radiation is low, and the development of leukemia is related to older age but not disease duration, suggesting that the treatment exposure may be a more important risk factor than the disease itself.

*Erythromelalgia* is a curious syndrome of unknown etiology associated with thrombocytosis, primarily involving the lower extremities and manifested usually by erythema, warmth, and pain of the affected appendage and occasionally digital infarction. It occurs with a variable frequency in myeloproliferative disorder patients and is usually responsive to salicylates. Some of the central nervous system symptoms observed in patients with PV, such as ocular migraine, may represent a variant of erythromelalgia.

If left uncontrolled, erythrocytosis can lead to thrombosis involving vital organs such as the liver, heart, brain, or lungs. Patients with massive splenomegaly are particularly prone to thrombotic events because the associated increase in plasma volume masks the true extent of the red cell mass elevation as measured by the hematocrit or hemoglobin level. A “normal” hematocrit or hemoglobin level in a PV patient with massive splenomegaly should be considered indicative of an elevated red cell mass until proven otherwise.

### **Rx Treatment:** **POLYCYTHEMIA VERA**

PV is generally an indolent disorder whose clinical course is measured in decades, and its medical management should reflect its tempo. Thrombosis due to erythrocytosis is the most significant complication, and maintenance of the hemoglobin level at  $\leq 140$  g/L (14 g/dL; hematocrit  $< 45\%$ ) in men and  $\leq 120$  g/L (12 g/dL; hematocrit  $< 42\%$ ) in women is mandatory to avoid thrombotic complications. Phlebotomy serves initially to reduce hyperviscosity by bringing the red cell mass into the normal range. Periodic phlebotomies thereafter serve to maintain

the red cell mass within the normal range and to induce a state of iron deficiency, which prevents an accelerated reexpansion of the red cell mass. In most PV patients, once an iron-deficient state is achieved, phlebotomy is usually only required at 3-month intervals. Neither phlebotomy nor iron deficiency increases the platelet count relative to the effect of the disease itself, and thrombocytosis is not correlated with thrombosis in PV, in contrast to the strong correlation between erythrocytosis and thrombosis in this disease. The use of salicylates as a tonic against thrombosis in PV patients is potentially harmful if the red cell mass is not controlled by phlebotomy. Anticoagulants are only indicated when a thrombosis has occurred and can be difficult to monitor owing to the artifactual imbalance between the test tube anticoagulant and plasma that occurs when blood from these patients is assayed for prothrombin or partial thromboplastin activity. Asymptomatic hyperuricemia ( $< 10$  mg%) requires no therapy, but allopurinol should be administered to avoid further elevation of the uric acid when chemotherapy is employed to reduce splenomegaly or leukocytosis or to treat pruritus. Generalized pruritus intractable to antihistamines or antidepressants such as doxepin can be a major problem in PV; hydroxyurea, interferon (IFN)- $\alpha$ , and psoralens with ultraviolet light in the A range (PUVA) therapy are other methods of palliation. Asymptomatic thrombocytosis requires no therapy unless the platelet count is sufficiently high to cause an acquired form of von Willebrand's disease due to proteolysis of high-molecular-weight vWF multimers. Symptomatic splenomegaly can be treated with IFN- $\alpha$ . Although the drug can be associated with significant side effects when used chronically, IFN- $\alpha$  reduces JAK2 V617F expression in PV patients, and its role in this disorder may be expanding. Anagrelide, a phosphodiesterase inhibitor, can reduce the platelet count and, if tolerated, is preferable to hydroxyurea because it lacks marrow toxicity. A reduction in platelet number may be necessary in the treatment of erythromelalgia or ocular migraine if salicylates are not effective or the platelet count is sufficiently high to cause an hemorrhagic diathesis. Alkylating agents and radioactive sodium phosphate ( $^{32}\text{P}$ ) are leukemogenic in PV, and their use should be avoided. If a cytotoxic agent must be used, hydroxyurea is preferred, but this drug does not prevent either thrombosis or myelofibrosis in this disorder. Chemotherapy should be used for as short a time as possible. In some patients, massive splenomegaly unresponsive to reduction by hydroxyurea or IFN- $\alpha$  therapy and associated with intractable weight loss requires splenectomy. In some patients with end-stage disease, pulmonary hypertension may develop due to fibrosis and extramedullary hematopoiesis. Allogeneic bone marrow transplantation may be curative in young patients.

Most patients with PV can live long lives without functional impairment when their red cell mass is effectively managed with phlebotomy. Chemotherapy is never indicated to control the red cell mass unless venous access is inadequate.

## CHRONIC IDIOPATHIC MYELOFIBROSIS

Chronic IMF (other designations include *agnogenic myeloid metaplasia* or *myelofibrosis with myeloid metaplasia*) is a clonal disorder of a multipotent hematopoietic progenitor cell of unknown etiology characterized by marrow fibrosis, extramedullary hematopoiesis, and splenomegaly. Chronic IMF is the least common chronic myeloproliferative disorder, and establishing this diagnosis in the absence of a specific clonal marker is difficult because myelofibrosis and splenomegaly are also features of both PV and CML. Furthermore, myelofibrosis and splenomegaly also occur in a variety of benign and malignant disorders (Table 13-3), many of which are amenable to specific therapies not effective in chronic IMF. In contrast to the other chronic myeloproliferative disorders and so-called acute or malignant myelofibrosis, which can occur at any age, chronic IMF primarily afflicts individuals in their sixth decade or later.

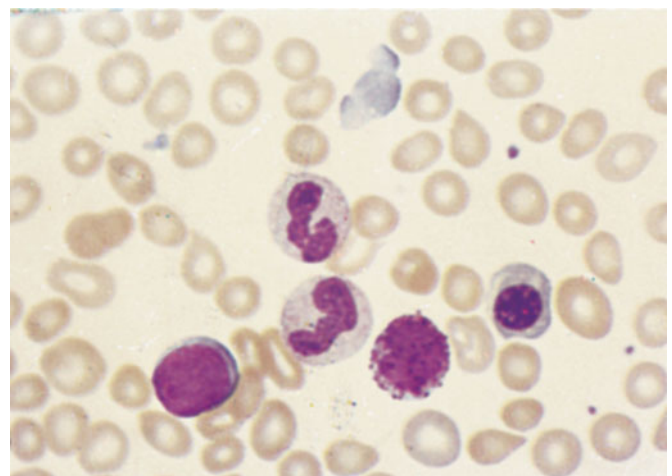
### ETIOLOGY

The etiology of chronic IMF is unknown. Nonrandom chromosome abnormalities such as 9p, 20q-, 13q-, trisomy 8 or 9, or partial trisomy 1q are common, but no cytogenetic abnormality specific to the disease has been identified. The degree of myelofibrosis and the

extent of extramedullary hematopoiesis are also not related. Fibrosis in this disorder is associated with overproduction of transforming growth factor  $\beta$  and tissue inhibitors of metalloproteinases; osteosclerosis is associated with overproduction of osteoprotegerin, an osteoclast inhibitor. Marrow angiogenesis occurs due to increased production of vascular endothelial growth factor (VEGF). Importantly, fibroblasts in chronic IMF are polyclonal and not part of the neoplastic clone.

### CLINICAL FEATURES

No signs or symptoms are specific for chronic IMF. Many patients are asymptomatic at presentation, and the disease is usually detected by the discovery of splenic enlargement and/or abnormal blood counts during a routine examination. However, in contrast to its companion myeloproliferative disorders, night sweats, fatigue, and weight loss may be presenting complaints. A blood smear shows the characteristic features of extramedullary hematopoiesis: teardrop-shaped red cells, nucleated red cells, myelocytes, and promyelocytes; myeloblasts may also be present (Fig. 13-1). Anemia, usually mild initially, is the rule, and the leukocyte and platelet counts are either normal or increased, but either can be depressed. Mild hepatomegaly may accompany the splenomegaly but is unusual in the absence of splenic enlargement; isolated lymphadenopathy should suggest another diagnosis. Both serum lactate dehydrogenase and alkaline phosphatase levels can be elevated. The LAP score can be low, normal, or high. Marrow is usually inaspirable due to the myelofibrosis (Fig. 13-2), and bone x-rays may reveal



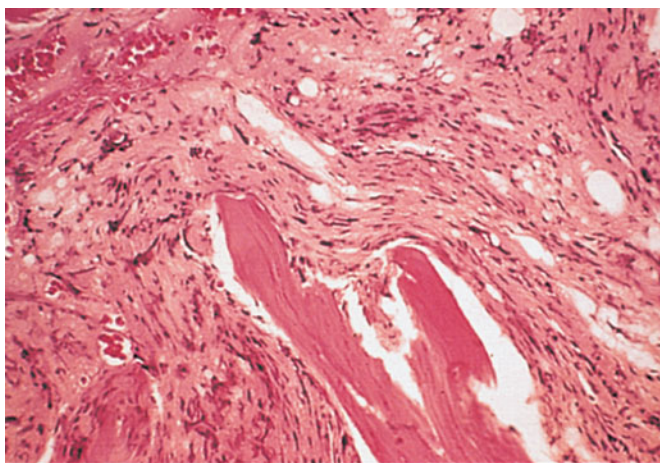
**FIGURE 13-1**

Teardrop-shaped red blood cells indicative of membrane damage from passage through the spleen, a nucleated red blood cell, and immature myeloid cells indicative of extramedullary hematopoiesis are noted. This peripheral blood smear is related to any cause of extramedullary hematopoiesis.

**TABLE 13-3**

### DISORDERS CAUSING MYELOFIBROSIS

Malignant	Nonmalignant
Acute leukemia (lymphocytic, myelogenous, megakaryocytic)	HIV infection
Chronic myelogenous leukemia	Hyperparathyroidism
Hairy cell leukemia	Renal osteodystrophy
Hodgkin's disease	Systemic lupus erythematosus
Idiopathic myelofibrosis	Tuberculosis
Lymphoma	Vitamin D deficiency
Multiple myeloma	Thorium dioxide exposure
Myelodysplasia	Gray platelet syndrome
Metastatic carcinoma	
Polycythemia vera	
Systemic mastocytosis	



**FIGURE 13-2**

This marrow section shows the marrow cavity replaced by fibrous tissue composed of reticulin fibers and collagen. When this fibrosis is due to a primary hematologic process, it is called *myelofibrosis*. When the fibrosis is secondary to a tumor or a granulomatous process, it is called *myelophthisis*.

osteosclerosis. Exuberant extramedullary hematopoiesis can cause ascites, portal, pulmonary or intracranial hypertension, intestinal or ureteral obstruction, pericardial tamponade, spinal cord compression, or skin nodules. Splenic enlargement can be sufficiently rapid to cause splenic infarction with fever and pleuritic chest pain. Hyperuricemia and secondary gout may ensue.

## DIAGNOSIS

Although the clinical picture just described is characteristic of chronic IMF, all of the clinical features described can also be observed in PV or CML. Massive splenomegaly commonly masks erythrocytosis in PV, and reports of intraabdominal thromboses in chronic IMF most likely represent instances of unrecognized PV. In some patients with chronic IMF, erythrocytosis has developed during the course of the disease. Furthermore, because many other disorders have features that overlap with chronic IMF but respond to distinctly different therapies, the diagnosis of chronic IMF is one of exclusion, which requires that the disorders listed in Table 13-3 be ruled out. A diagnostic algorithm has been proposed but does not distinguish one disease causing myeloid metaplasia from another.

The presence of teardrop-shaped red cells, nucleated red cells, myelocytes, and promyelocytes establishes the presence of extramedullary hematopoiesis, whereas the presence of leukocytosis, thrombocytosis with large and bizarre platelets, and circulating myelocytes suggests the presence of a myeloproliferative disorder as opposed to a secondary form of myelofibrosis (Table 13-3). Marrow is usually not aspirable due to increased marrow reticulin,

but marrow biopsy will reveal a hypercellular marrow with trilineage hyperplasia and, in particular, increased numbers of megakaryocytes in clusters and with large dysplastic nuclei. However, no characteristic morphologic abnormalities distinguish IMF from the other chronic myeloproliferative disorders. Splenomegaly due to extramedullary hematopoiesis may be sufficiently massive to cause portal hypertension and variceal formation. In some patients, exuberant extramedullary hematopoiesis can dominate the clinical picture. An intriguing feature of chronic IMF is the occurrence of autoimmune abnormalities such as immune complexes, antinuclear antibodies, rheumatoid factor, or a positive Coombs test. Whether these represent a host reaction to the disorder or are involved in its pathogenesis is unknown. Cytogenetic analysis of blood is useful both to exclude CML and for prognostic purposes because complex karyotype abnormalities portend a poor prognosis in chronic IMF. For unknown reasons, the number of circulating CD34+ cells is markedly increased in chronic IMF (>15,000/ $\mu$ L) compared to the other chronic myeloproliferative disorders, unless they too develop myeloid metaplasia.

Importantly, ~45% of chronic IMF patients, like patients with its companion myeloproliferative disorders PV and ET, express the JAK2 V617F mutation, often as homozygotes. Such patients had a poorer survival in one retrospective study but not in another, where they were found to be older and to have higher hematocrits than those patients who were JAK2 V617F-negative.

## COMPLICATIONS

Survival in chronic IMF varies according to specific clinical features (Table 13-4) but is shorter than in patients with PV or ET. The natural history of chronic IMF is one of increasing marrow failure with transfusion-dependent anemia and increasing organomegaly due to extramedullary hematopoiesis. As with CML, chronic IMF can evolve from a chronic phase to an accelerated phase with constitutional symptoms and increasing marrow failure. About 10% of patients develop an aggressive form of acute leukemia for which therapy is usually ineffective. Important prognostic factors for disease acceleration include anemia, leukocytosis, thrombocytopenia, the presence of circulating myeloblasts, older age, the presence of complex cytogenetic abnormalities, and constitutional symptoms such as unexplained fever, night sweats, or weight loss.

### **Rx Treatment:** **CHRONIC IDIOPATHIC MYELOFIBROSIS**

No specific therapy exists for chronic IMF. Anemia may be due to gastrointestinal blood loss and exacerbated by folic acid deficiency, and in rare instances, pyridoxine



**TABLE 13-4**

<b>RISK STRATIFICATION FOR IDIOPATHIC MYELOFIBROSIS</b>		
<b>A. Prognostic factors<sup>a</sup></b>		
Hemoglobin <10 gm%		
White cell count <4000/ $\mu$ L or >30,000/ $\mu$ L		
<b>Number of prognostic factors</b>	<b>Risk group</b>	<b>Median survival (months)</b>
0	Low	93
1–2	High	17
<b>B. Prognostic factors<sup>b</sup></b>		
Hemoglobin <10 gm%		
Constitutional symptoms		
Blast cells >1%		
<b>Number of prognostic factors</b>	<b>Risk group</b>	<b>Median survival (months)</b>
0–1	Low	99
2–3	High	21
<b>C. Prognostic factors<sup>c</sup></b>		
<b>Median survival (months)</b>		
Age <65 years		
Hemoglobin $\leq$ 10 gm%		
Karyotype: Normal	54	
Abnormal	22	
Age <65 years		
Hemoglobin >10 gm%		
Karyotype: Normal	180	
Abnormal	72	
Age >65 years		
Hemoglobin $\leq$ 10 gm%		
Karyotype: Normal	44	
Abnormal	16	
Age >65 years		
Hemoglobin >10 gm%		
Karyotype: Normal	70	
Abnormal	78	

<sup>a</sup>From B Dupriez et al. Blood 88:1013, 1996.

<sup>b</sup>From F Cervantes et al. Br J Haematol 102:684, 1998.

<sup>c</sup>From JT Reilly et al. Br J Haematol 98:96, 1997.

therapy has been effective. However, anemia is more often due to ineffective erythropoiesis uncompensated by extramedullary hematopoiesis in the spleen and liver. Neither recombinant erythropoietin nor androgens, such as Danazol, have proved consistently effective as therapy for anemia. Erythropoietin may worsen splenomegaly and will be ineffective if the serum erythropoietin level is >125 mU/L. A red cell splenic sequestration study can establish the presence of hypersplenism, for which splenectomy is indicated. Splenectomy may also be necessary if splenomegaly impairs alimentation and should be performed before cachexia sets in. In this situation, splenectomy should not be avoided because of concern over rebound thrombocytosis, loss of hematopoietic capacity, or compensatory hepatomegaly. However, for unexplained reasons, splenectomy increases the risk of

blastic transformation. Splenic irradiation is, at best, temporarily palliative and associated with a significant risk of neutropenia and infection. Allopurinol can control significant hyperuricemia, and hydroxyurea has proved useful for controlling organomegaly in some patients. The role of IFN- $\alpha$  is still undefined, and its side effects are more pronounced in the older individuals who are usually afflicted with this disorder. Glucocorticoids have been used to control constitutional symptoms and autoimmune complications and may ameliorate anemia alone or in combination with low-dose thalidomide (50–100 mg/d). Allogeneic bone marrow transplantation is the only curative treatment and should be considered in younger patients; reduced-intensity conditioning regimens may permit hematopoietic cell transplantation to be extended to older individuals.

## ESSENTIAL THROMBOCYTOSIS

Essential thrombocytosis (other designations include *essential thrombocythemia*, *idiopathic thrombocytosis*, *primary thrombocytosis*, *hemorrhagic thrombocythemia*) is a clonal disorder of unknown etiology involving a multipotent hematopoietic progenitor cell manifested clinically by overproduction of platelets without a definable cause. ET is an uncommon disorder, with an incidence of 1–2/100,000 and a distinct female predominance, in contrast to the other chronic myeloproliferative disorders. No clonal marker is available to distinguish ET consistently from the more common nonclonal, reactive forms of thrombocytosis (Table 13-5), making its diagnosis difficult. Once considered a disease of the elderly and responsible for significant morbidity due to hemorrhage or thrombosis, with the widespread use of electronic cell counters, it is now clear that ET can occur at any age in adults and often without symptoms or disturbances of hemostasis. There is an unexplained female predominance in contrast to the other chronic myeloproliferative disorders or the reactive forms of thrombocytosis where no sex difference exists. Because no specific clonal marker is available, clinical criteria have been proposed to distinguish ET from the other chronic myeloproliferative disorders, which may also present with thrombocytosis but have differing prognoses and therapy (Table 13-5). These criteria do not establish clonality; therefore, they are truly useful only in identifying disorders such as CML, PV, or myelodysplasia, which can masquerade as ET, as opposed to actually establishing the presence of ET. Furthermore, as with “idiopathic” erythrocytosis, nonclonal benign forms of

thrombocytosis exist (such as hereditary overproduction of thrombopoietin) that are not widely recognized because we currently lack adequate diagnostic tools. 161

## ETIOLOGY

Megakaryocytopoiesis and platelet production depend on thrombopoietin and its receptor, Mpl. As in the case of early erythroid and myeloid progenitor cells, early megakaryocytic progenitors require the presence of interleukin (IL)-3 and stem cell factor for optimal proliferation in addition to thrombopoietin. Their subsequent development is also enhanced by the chemokine stromal cell–derived factor 1 (SDF-1). However, megakaryocyte maturation and differentiation require thrombopoietin.

Megakaryocytes are unique among hematopoietic progenitor cells because reduplication of their genome is endomitotic rather than mitotic. In the absence of thrombopoietin, endomitotic megakaryocytic reduplication and, by extension, the cytoplasmic development necessary for platelet production are impaired. Like erythropoietin, thrombopoietin is produced in both the liver and the kidneys, and an inverse correlation exists between the platelet count and plasma thrombopoietic activity. Like erythropoietin, plasma levels of thrombopoietin are controlled largely by the size of its progenitor cell pool. In contrast to erythropoietin, but like its myeloid counterparts, granulocyte- and granulocyte-macrophage colony-stimulating factors, thrombopoietin not only enhances the proliferation of its target cells but also enhances the reactivity of their end-stage product, the platelet. In addition to its role in thrombopoiesis, thrombopoietin also enhances the survival of multipotent hematopoietic stem cells.

The clonal nature of ET was established by analysis of glucose-6-phosphate dehydrogenase isoenzyme expression in patients hemizygous for this gene, by analysis of X-linked DNA polymorphisms in informative women patients, and by the expression in patients of nonrandom, although variable, cytogenetic abnormalities. Although thrombocytosis is its principal manifestation, like the other chronic myeloproliferative disorders, a multipotent hematopoietic progenitor cell is involved in ET. Furthermore, a number of families have been described in which ET was inherited, in one instance as an autosomal dominant trait. In addition to ET, IMF and PV have also been observed in some kindreds.

## CLINICAL FEATURES

Clinically, ET is most often identified incidentally when a platelet count is obtained during the course of a routine medical evaluation. Occasionally, review of previous blood counts reveals that an elevated platelet count was present but overlooked for many years. No symptoms or signs are specific for ET, but these patients can have

TABLE 13-5

### CAUSES OF THROMBOCYTOSIS

Tissue inflammation: collagen vascular disease, inflammatory bowel disease
Malignancy
Infection
Myeloproliferative disorders: polycythemia vera, idiopathic myelofibrosis, essential thrombocytosis, chronic myelogenous leukemia
Myelodysplastic disorders: 5q-syndrome, idiopathic refractory sideroblastic anemia
Postsplenectomy or hyposplenism
Hemorrhage
Iron-deficiency anemia
Surgery
Rebound: Correction of vitamin B <sub>12</sub> or folate deficiency, post-ethanol abuse
Hemolysis
Familial: Thrombopoietin overproduction, constitutive Mpl activation

162 hemorrhagic and thrombotic tendencies expressed as easy bruising for the former and microvascular occlusions for the latter, such as erythromelalgia, ocular migraine, or TIAs. Physical examination is generally unremarkable except occasionally for mild splenomegaly. Massive splenomegaly is more indicative of another myeloproliferative disorder, in particular PV, IMF, or CML.

Anemia is unusual, but a mild neutrophilic leukocytosis is not. The blood smear is most remarkable for the number of platelets present, some of which may be very large. The LAP score is either normal or elevated. The large mass of circulating platelets may prevent the accurate measurement of serum potassium due to release of platelet potassium upon blood clotting. This type of hyperkalemia is a laboratory artifact and not associated with electrocardiographic abnormalities. Similarly, arterial oxygen measurements can be inaccurate unless thrombocythemic blood is collected on ice. The prothrombin and partial thromboplastin times are normal, although abnormalities of platelet function such as a prolonged bleeding time and impaired platelet aggregation can be present. However, in spite of much study, no platelet function abnormalities are characteristic of ET, and no platelet function test predicts the risk of clinically significant bleeding or thrombosis.

The elevated platelet count may hinder marrow aspiration, but marrow biopsy usually reveals megakaryocyte hyperplasia and hypertrophy, as well as an overall increase in marrow cellularity. If marrow reticulin is increased, another diagnosis should be considered. The absence of stainable iron demands an explanation because iron deficiency alone can cause thrombocytosis, and absent marrow iron in the presence of marrow hypercellularity is a feature of PV.

Nonrandom cytogenetic abnormalities occur in ET but are uncommon, and no specific or consistent abnormality is notable, even those involving chromosomes 3 and 1, where the genes for thrombopoietin and its receptor Mpl, respectively, are located.

## DIAGNOSIS

Thrombocytosis is encountered in a broad variety of clinical disorders (Table 13-5) in many of which production of cytokines is increased. The absolute level of the platelet count is not a useful diagnostic aid for distinguishing between benign and clonal causes of thrombocytosis. About 50% of ET patients express the JAK2 V617F mutation. When JAK2 V617F is absent, cytogenetic evaluation is mandatory to determine if the thrombocytosis is due to CML or a myelodysplastic disorder such as the 5q- syndrome. Because the bcr-abl translocation can be present in the absence of the Ph chromosome, and because bcr-abl RT-PCR is associated with false-positive results, fluorescence in situ hybridization (FISH) analysis for bcr-abl is the preferred assay in

patients with thrombocytosis in whom a cytogenetic study for the Ph chromosome is negative. Anemia and ringed sideroblasts are not features of ET, but they are features of idiopathic refractory sideroblastic anemia, and in some of these patients the thrombocytosis occurs in association with JAK2 V617F expression. Massive splenomegaly should suggest the presence of another myeloproliferative disorder, and in this setting a red cell mass determination should be performed because splenomegaly can mask the presence of erythrocytosis. Importantly, what appears to be ET can evolve into PV or IMF after a period of many years, revealing the true nature of the underlying myeloproliferative disorder.

## COMPLICATIONS

Perhaps no other condition in clinical medicine has caused otherwise astute physicians to intervene inappropriately more often than thrombocytosis, particularly if the platelet count is  $>1 \times 10^6/\mu\text{L}$ . It is commonly believed that a high platelet count causes intravascular stasis and thrombosis; however, no controlled clinical study has ever established this association, and in patients  $<60$  years of age, the incidence of thrombosis was not greater in patients with thrombocytosis than in age-matched controls.

To the contrary, very high platelet counts are associated primarily with hemorrhage due to acquired von Willebrand's disease. This is not meant to imply that an elevated platelet count cannot cause symptoms in a patient with ET, but rather that the focus should be on the patient, not the platelet count. For example, some of the most dramatic neurologic problems in ET are migraine-related and respond only to lowering of the platelet count, whereas other symptoms such as erythromelalgia respond simply to platelet cyclooxygenase 1 inhibitors such as aspirin or ibuprofen, without a reduction in platelet number. Still others may represent an interaction between an atherosclerotic vascular system and a high platelet count, and others may have no relationship to the platelet count whatsoever. Recognition that PV can present with thrombocytosis as well as the discovery of previously unrecognized causes of hypercoagulability (Chap. 20) make the older literature on the complications of thrombocytosis unreliable.

### **Rx Treatment:** **ESSENTIAL THROMBOCYTOSIS**

Survival of patients with ET is not different than for the general population. An elevated platelet count in an asymptomatic patient without cardiovascular risk factors requires no therapy. Indeed, before any therapy is initiated in a patient with thrombocytosis, the cause of

symptoms must be clearly identified as due to the elevated platelet count. When the platelet count rises above  $1 \times 10^6/\mu\text{L}$ , a substantial quantity of high-molecular-weight von Willebrand multimers are removed from the circulation and destroyed by the platelets, resulting in an acquired form of von Willebrand's disease. This can be identified by a reduction in ristocetin cofactor activity. In this situation, aspirin could promote hemorrhage. Bleeding in this situation usually responds to  $\epsilon$ -aminocaproic acid, which can be given prophylactically before and after elective surgery. Plateletpheresis is at best a temporary and inefficient remedy that is rarely required. Importantly, ET patients treated with  $^{32}\text{P}$  or alkylating agents are at risk of developing acute leukemia without any proof of benefit; combining either therapy with hydroxyurea increases this risk. If platelet reduction is deemed necessary on the basis of symptoms refractory to salicylates alone, IFN- $\alpha$ , the quinazoline derivative, anagrelide, or hydroxyurea can be used to reduce the platelet count, but none of these is uniformly effective nor without significant side effects. Hydroxyurea and aspirin are more effective than anagrelide and aspirin for prevention of TIAs but not more effective for the prevention of other types of arterial thrombosis and actually less effective for venous thrombosis. Normalizing the platelet count does not prevent either arterial or venous thrombosis. Risk of gastrointestinal bleeding is also higher when aspirin is combined with anagrelide.

As more clinical experience is acquired, ET is more benign than previously thought. Evolution to acute

leukemia is more likely to be a consequence of therapy than of the disease itself. In managing patients with thrombocytosis, the physician's first obligation is to do no harm.

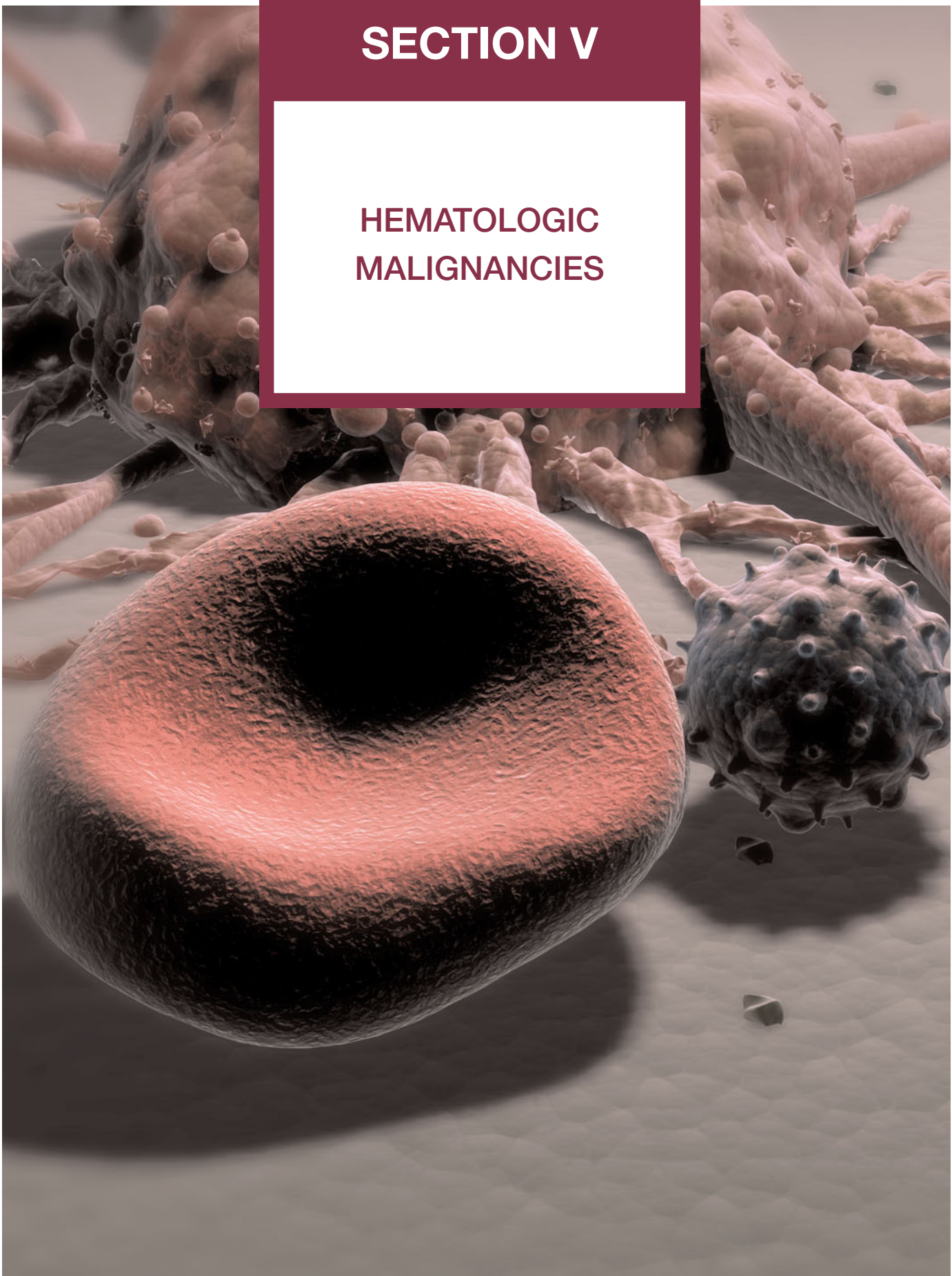
## FURTHER READINGS

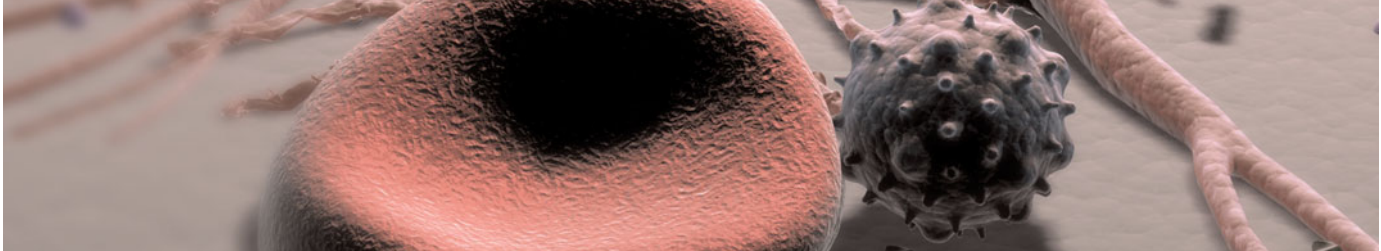
- ATALLA E, VERSTOVSEK S: Prospect of JAK2 inhibitor therapy in myeloproliferative neoplasms. *Expert Rev Anticancer Ther* 9:663, 2009
- BUSS DH et al: The incidence of thrombotic and hemorrhagic disorders in association with extreme thrombocytosis: An analysis of 129 cases. *Am J Hematol* 20:365, 1985
- ELLIOT MA et al: Thrombosis and hemorrhage in polycythemia vera and essential thrombocythaemia. *Br J Haematol* 128:275, 2005
- LEVINE RL, GILLILAND DG: JAK-2 mutations and their relevance to myeloproliferative disease. *Curr Opin Hematol* 14:43, 2007
- LOGAN MS et al: Symptomatic splenomegaly in polycythemia vera: A review of the indications for splenectomy and perioperative considerations. *Am Surg* 75:363, 2009
- MESA RA: How I treat symptomatic splenomegaly in patients with myelofibrosis. *Blood* 113:5394, 2009
- REILLY JT: Idiopathic myelofibrosis: Pathogenesis to treatment. *Hematol Oncol* 24:56, 2006
- SPIVAK JL: Polycythemia vera: Myths, mechanisms, and management. *Blood* 100:4272, 2002
- VAINCENKER W et al: A unique activating mutation in JAK2 (V617F) is at the origin of polycythemia vera and allows a new classification of myeloproliferative diseases. *Hematology Am Soc Hematol Educ Program* 195, 2005
- VANNUCCHI AM et al: Advances in understanding and management of myeloproliferative neoplasms. *CA Cancer J Clin* 59:171, 2009
- ZHAN H, Spivak JL: The diagnosis and management of polycythemia vera, essential thrombocythemia, and primary myelofibrosis in the JAK2V617F era. *Clin Adv Hematol Oncol* 7:334, 2009

*This page intentionally left blank*

# SECTION V

## HEMATOLOGIC MALIGNANCIES





## CHAPTER 14

# ACUTE AND CHRONIC MYELOID LEUKEMIA

Meir Wetzler ■ John C. Byrd ■ Clara D. Bloomfield

■ Acute Myeloid Leukemia . . . . .	166	Incidence . . . . .	175
Incidence . . . . .	166	Definition . . . . .	175
Etiology . . . . .	166	Etiology . . . . .	175
Classification . . . . .	167	Pathophysiology . . . . .	176
Clinical Presentation . . . . .	168	Clinical Presentation . . . . .	176
Prognostic Factors . . . . .	171	Prognostic Factors . . . . .	177
■ Chronic Myelogenous Leukemia . . . . .	175	■ Further Readings . . . . .	181

The myeloid leukemias are a heterogeneous group of diseases characterized by infiltration of the blood, bone marrow, and other tissues by neoplastic cells of the hematopoietic system. In 2006 the estimated number of new myeloid leukemia cases in the United States was 16,430. These leukemias comprise a spectrum of malignancies that, untreated, range from rapidly fatal to slowly growing. Based on their untreated course, the myeloid leukemias have traditionally been designated acute or chronic.

### ACUTE MYELOID LEUKEMIA

#### INCIDENCE

The incidence of acute myeloid leukemia (AML) is ~3.7 per 100,000 people per year, and the age-adjusted incidence is higher in men than in women (4.6 versus 3.0). AML incidence increases with age; it is 1.9 in individuals <65 years and 18.6 in those >65. A significant increase in AML incidence has occurred over the past 10 years.

#### ETIOLOGY

Heredity, radiation, chemical and other occupational exposures, and drugs have been implicated in the development of AML. No direct evidence suggests a viral etiology.

#### Heredity

Certain syndromes with somatic cell chromosome aneuploidy, such as trisomy 21 noted in Down's syndrome, are associated with an increased incidence of AML. Inherited diseases with defective DNA repair, e.g., Fanconi's anemia, Bloom's syndrome, and ataxia telangiectasia, are also associated with AML. Congenital neutropenia (Kostmann's syndrome) is a disease with mutations in the granulocyte colony-stimulating factor (G-CSF) receptor and, often, neutrophil elastase that may evolve into AML. Myeloproliferative syndromes may also evolve into AML (Chap. 13). Germ-line mutations of CCAAT/enhancer-binding protein  $\alpha$  (C/EBP $\alpha$ ), runt-related transcription factor 1 (RUNX1), and tumor protein p53 (TP53) have also been associated with a higher predisposition to AML in some series.

#### Radiation

Survivors of the atomic bomb explosions in Japan had an increased incidence of myeloid leukemias that peaked 5–7 years after exposure. Therapeutic radiation alone seems to add little risk of AML but can increase the risk in people also exposed to alkylating agents.

#### Chemical and Other Exposures

Exposure to benzene, a solvent used in the chemical, plastic, rubber, and pharmaceutical industries, is associated

with an increased incidence of AML. Smoking and exposure to petroleum products, paint, embalming fluids, ethylene oxide, herbicides, and pesticides, have also been associated with an increased risk of AML.

## Drugs

Anticancer drugs are the leading cause of therapy-associated AML. Alkylating agent-associated leukemias occur on average 4–6 years after exposure, and affected individuals have aberrations in chromosomes 5 and 7. Topoisomerase II inhibitor-associated leukemias occur 1–3 years after exposure, and affected individuals often have aberrations involving chromosome 11q23. Chloramphenicol, phenylbutazone, and, less commonly, chloroquine and methoxypropylsulfonamide can result in bone marrow failure that may evolve into AML.

## CLASSIFICATION

The World Health Organization (WHO) classification (Table 14-1) includes different biologically distinct groups based on immunophenotype, clinical features, and cytogenetic and molecular abnormalities in addition to morphology. In contrast to the previously used French-American-British (FAB) schema, the WHO classification places limited reliance on cytochemistry. Because much of the recent literature and some ongoing studies use the FAB classification, a description of this system is also provided in Table 14-1. A major difference between the WHO and FAB systems is the blast cutoff for a diagnosis of AML as opposed to myelodysplastic syndrome (MDS); it is 20% in the WHO classification and 30% in the FAB. AML with 20–30% blasts as defined by the WHO classification can benefit from approved therapies for MDS (such as decitabine or 5-azacytidine) that were approved in the past by the Food and Drug Administration (FDA) for marketing based on trials using the FAB criteria.

Importantly, the WHO schema is the first leukemia classification system to consider genetic along with morphologic features to define different subsets of AML.

### Immunophenotype and Relevance to the WHO Classification

The immunophenotype of human leukemia cells can be studied by multiparameter flow cytometry after the cells are labeled with monoclonal antibodies to cell-surface antigens. This can be important for separating AML from acute lymphoblastic leukemia (ALL) and identifying some types of AML. For example, AML that is minimally differentiated (immature morphology and no lineage-specific cytochemical reactions) is diagnosed by flow-cytometric demonstration of the myeloid-specific antigens cluster designation (CD) 13 or 33. Similarly, acute megakaryoblastic leukemia can often be diagnosed only by expression of

**TABLE 14-1**

### ACUTE MYELOID LEUKEMIA (AML) CLASSIFICATION SYSTEMS

#### World Health Organization Classification<sup>a</sup>

- I. AML with recurrent genetic abnormalities
  - AML with t(8;21)(q22;q22);*RUNX1/RUNX1T1*<sup>b</sup>
  - AML with abnormal bone marrow eosinophils [inv(16)(p13q22) or t(16;16)(p13;q22);*CBFB/MYH11*]<sup>b</sup>
  - Acute promyelocytic leukemia [AML with t(15;17)(q22;q12) (*PML/RARA*) and variants]<sup>b</sup>
  - AML with 11q23 (*MLL*) abnormalities
- II. AML with multilineage dysplasia
  - Following a myelodysplastic syndrome or myelodysplastic syndrome/myeloproliferative disorder
  - Without antecedent myelodysplastic syndrome
- III. AML and myelodysplastic syndromes, therapy-related
  - Alkylating agent-related
  - Topoisomerase type II inhibitor-related
  - Other types
- IV. AML not otherwise categorized
  - AML minimally differentiated
  - AML without maturation
  - AML with maturation
    - Acute myelomonocytic leukemia
    - Acute monoblastic and monocytic leukemia
    - Acute erythroid leukemia
    - Acute megakaryoblastic leukemia
    - Acute basophilic leukemia
    - Acute panmyelosis with myelofibrosis
    - Myeloid sarcoma

#### French-American-British (FAB) Classification<sup>c</sup> Incidence

M0: Minimally differentiated leukemia	5%
M1: Myeloblastic leukemia without maturation	20%
M2: Myeloblastic leukemia with maturation	30%
M3: Hypergranular promyelocytic leukemia	10%
M4: Myelomonocytic leukemia	20%
M4Eo: Variant: Increase in abnormal marrow eosinophils	
M5: Monocytic leukemia	10%
M6: Erythroleukemia (Di Guglielmo's disease)	4%
M7: Megakaryoblastic leukemia	1%

<sup>a</sup>ES Jaffe et al: *World Health Organization Classification of Tumours*. Lyon, IARC Press, 2001.

<sup>b</sup>Diagnosis is AML regardless of blast count.

<sup>c</sup>JM Bennett et al: *Ann Intern Med* 103:620, 1985.

the platelet-specific antigens CD41 and/or CD61. Although flow cytometry is useful, widely used, and, in some cases, essential for the diagnosis of AML, it is only supportive in establishing the different subtypes of AML through the WHO classification.

### Clinical Features and Relevance to the WHO Classification

The WHO classification considers clinical features in subdividing AML. For example, it identifies therapy-related



AML as a separate entity and subclassifies this group based on the specific types of prior chemotherapy received. It also divides AML with multilineage dysplasia based on the presence or absence of an antecedent MDS. These clinical features contribute to the prognosis of the specific type of AML.

### Genetic Findings and Relevance to the WHO Classification

The WHO classification is the first AML classification to incorporate genetic (chromosomal and molecular) information. Indeed, AML is first subclassified based on the presence or absence of specific recurrent genetic abnormalities. For example, AML FAB M3 is now designated *acute promyelocytic leukemia* (APL), based on the presence of either the t(15;17)(q22;q12) cytogenetic rearrangement or the *PML/RAR $\alpha$*  product of the translocation. Thus the WHO classification separates APL from all other types of AML as a first step and forces the clinician to correctly identify the entity and tailor treatment(s) accordingly.

#### Chromosomal Analyses

Chromosomal analysis of the leukemic cell provides the most important pretreatment prognostic information in AML. Two cytogenetic abnormalities have been invariably associated with specific morphologic features: t(15;17)(q22;q12) with APL and inv(16)(p13q22) with AML with abnormal bone marrow eosinophils. Many other chromosomal abnormalities have been associated primarily with one morphologic/immunophenotypic group, including t(8;21)(q22;q22) with slender Auer rods, expression of CD19, and abundance of normal eosinophils, and t(9;11)(p22;q23), as well as other translocations involving 11q23, with monocytic features. Many of the recurring chromosomal abnormalities in AML have been associated with specific clinical characteristics. More commonly associated with younger age are t(8;21) and t(15;17); with older age, del(5q) and del(7q). Myeloid sarcomas (see later) are associated with t(8;21) and disseminated intravascular coagulation (DIC) with t(15;17).

#### Molecular Classification

Molecular study of many recurring cytogenetic abnormalities has revealed genes that may be involved in leukemogenesis; this information is increasingly being incorporated into the WHO classification. For instance, the t(15;17) encodes a chimeric protein, promyelocytic leukemia (Pml)/retinoic acid receptor  $\alpha$  (Rar $\alpha$ ), which is formed by the fusion of the retinoic acid receptor  $\alpha$  (*RAR $\alpha$* ) gene from chromosome 17 and the promyelocytic leukemia (*PML*) gene from chromosome 15. The *RAR $\alpha$*  gene encodes a member of the nuclear hormone receptor family of transcription factors. After binding retinoic acid, *RAR $\alpha$*  can promote expression of a variety of genes. The 15;17 translocation juxtaposes *PML* with

*RAR $\alpha$*  in a head-to-tail configuration that is under the transcriptional control of *PML*. Three different breakpoints in the *PML* gene lead to various fusion proteins. The Pml-Rar $\alpha$  fusion protein tends to suppress gene transcription and blocks differentiation of the cells. Pharmacologic doses of the Rar $\alpha$  ligand, all-*trans*-retinoic acid (tretinoin), relieve the block and promote differentiation (see later). Similar examples exist with a variety of other balanced translocations and inversions, including the t(8;21), t(9;11), t(6;9), and inv(16).

Molecular aberrations are also being identified that are useful for classifying risk of relapse in patients without cytogenetic abnormalities. A partial tandem duplication (PTD) of the *MLL* gene is found in 5–10% of patients with normal cytogenetics and results in short remission duration. FMS-like tyrosine kinase 3 (Flt3) is a tyrosine kinase receptor important in the development of myeloid and lymphoid lineages. Activating mutations of the gene *FLT3* are present in ~30% of adult AML patients due to internal tandem duplications (ITDs) in the juxtamembrane domain or mutations of the activating loop of the kinase. These occur more commonly in patients with normal karyotype. Continuous activation of Flt3 and downstream target kinases, including signal transducer and activator of transcription protein 5, Ras/mitogen-activated protein kinase, and phosphatidylinositol 3-kinase/Akt, provides increased proliferation and antiapoptotic signals to the myeloid progenitor cell. Presence of *FLT3* ITD in patients with normal cytogenetics predicts for short remission duration and inferior survival. Other molecular prognostic factors in patients with normal karyotype AML include mutations of the nucleophosmin gene (*NPM1*) and *C/EBP $\alpha$*  that are associated with improved treatment outcome. In contrast, overexpression of genes such as brain and acute leukemia, cytoplasmic (*BAALC*) predicts for poor outcome. Gene expression profiles to predict outcome in normal karyotype AML patients are under active investigation.

## CLINICAL PRESENTATION

### Symptoms

Patients with AML most often present with nonspecific symptoms that begin gradually or abruptly and are the consequence of anemia, leukocytosis, leukopenia or leukocyte dysfunction, or thrombocytopenia. Nearly half have had symptoms for  $\leq 3$  months before the leukemia was diagnosed.

Half mention fatigue as the first symptom, but most complain of fatigue or weakness at the time of diagnosis. Anorexia and weight loss are common. Fever with or without an identifiable infection is the initial symptom in ~10% of patients. Signs of abnormal hemostasis (bleeding, easy bruising) are noted first in 5% of patients. On occasion, bone pain, lymphadenopathy, nonspecific cough, headache, or diaphoresis is the presenting symptom.

Rarely patients may present with symptoms from a mass lesion located in the soft tissues, breast, uterus, ovary, cranial or spinal dura, gastrointestinal tract, lung, mediastinum, prostate, bone, or other organs. The mass lesion represents a tumor of leukemic cells and is called a *granulocytic sarcoma*, or *chloroma*. Typical AML may occur simultaneously, later, or not at all in these patients. This rare presentation is more common in patients with t(8;21).

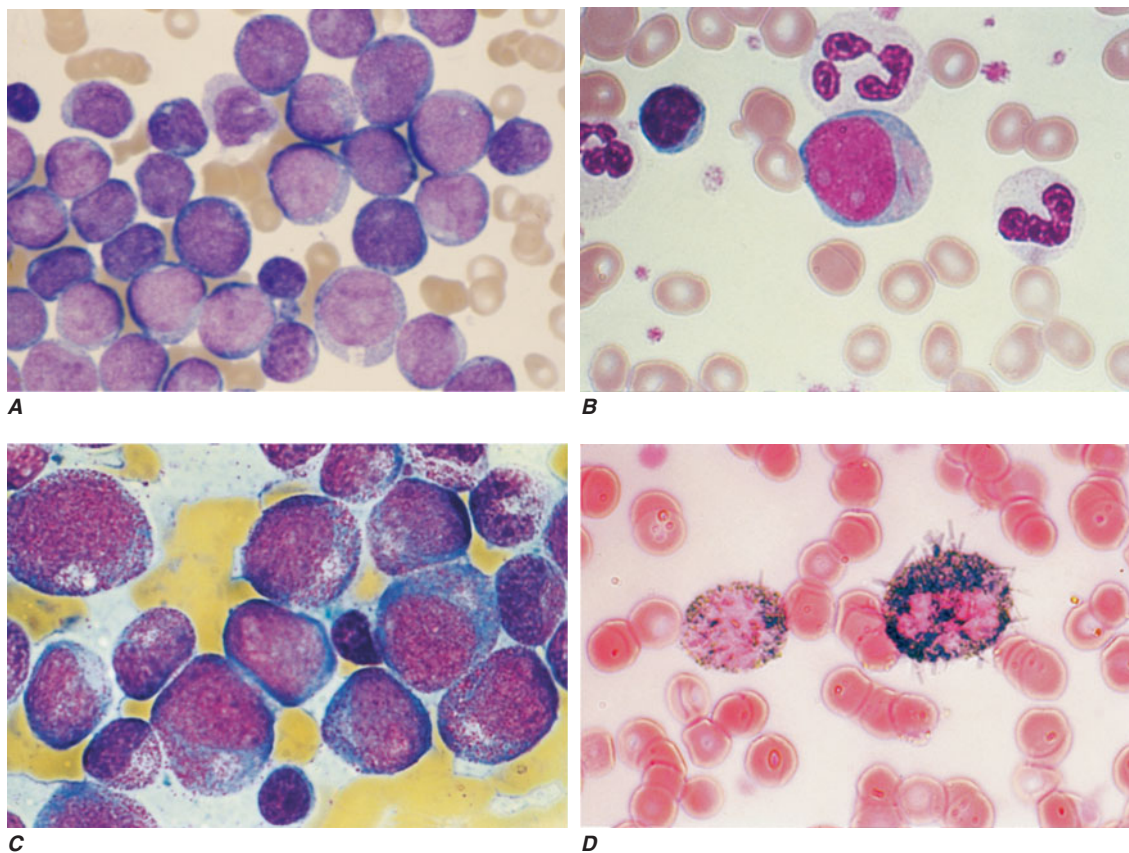
### Physical Findings

Fever, splenomegaly, hepatomegaly, lymphadenopathy, sternal tenderness, and evidence of infection and hemorrhage are often found at diagnosis. Significant gastrointestinal bleeding, intrapulmonary hemorrhage, or intracranial hemorrhage occur most often in APL. Bleeding associated with coagulopathy may also occur in monocytic AML and with extreme degrees of leukocytosis or thrombocytopenia in other morphologic subtypes. Retinal hemorrhages are detected in 15% of patients. Infiltration of the gingivae, skin, soft tissues, or the meninges with leukemic blasts at diagnosis is characteristic of the monocytic subtypes and those with 11q23 chromosomal abnormalities.

### Hematologic Findings

Anemia is usually present at diagnosis and can be severe. The degree varies considerably, irrespective of other hematologic findings, splenomegaly, or duration of symptoms. The anemia is usually normocytic normochromic. Decreased erythropoiesis often results in a reduced reticulocyte count, and red blood cell (RBC) survival is decreased by accelerated destruction. Active blood loss also contributes to the anemia.

The median presenting leukocyte count is  $\sim 5,000/\mu\text{L}$ . Between 25% and 40% of patients have counts  $< 5000/\mu\text{L}$ , and 20% have counts  $> 100,000/\mu\text{L}$ . Fewer than 5% have no detectable leukemic cells in the blood. The morphology of the malignant cell varies in different subsets. In AML the cytoplasm often contains primary (nonspecific) granules, and the nucleus shows fine, lacy chromatin with one or more nucleoli characteristic of immature cells. Abnormal rod-shaped granules called Auer rods are not uniformly present, but when they are, myeloid lineage is virtually certain (Fig. 14-1). Poor neutrophil function may be noted by impaired phagocytosis and migration and morphologically by abnormal lobulation and deficient granulation.



**FIGURE 14-1**

**Morphology of AML cells.** **A.** Uniform population of primitive myeloblasts with immature chromatin, nucleoli in some cells, and primary cytoplasmic granules. **B.** Leukemic myeloblast containing an Auer rod. **C.** Promyelocytic leukemia cells with

prominent cytoplasmic primary granules. **D.** Peroxidase stain shows dark blue color characteristic of peroxidase in granules in AML.

Platelet counts  $<100,000/\mu\text{L}$  are found at diagnosis in  $\sim 75\%$  of patients, and  $\sim 25\%$  have counts  $<25,000/\mu\text{L}$ . Both morphologic and functional platelet abnormalities can be observed, including large and bizarre shapes with abnormal granulation and inability of platelets to aggregate or adhere normally to one another.

### Pretreatment Evaluation

Once the diagnosis of AML is suspected, a rapid evaluation and initiation of appropriate therapy should follow (Table 14-2). In addition to clarifying the subtype of leukemia, initial studies should evaluate the overall functional integrity of the major organ systems, including the cardiovascular, pulmonary, hepatic, and renal systems. Factors that have prognostic significance, either for achieving complete remission (CR) or for predicting the duration of CR, should also be assessed before initiating treatment. Leukemic cells should be obtained from all patients and cryopreserved for future use as new tests and therapeutics become available. All patients should be evaluated for infection.

**TABLE 14-2**

#### INITIAL DIAGNOSTIC EVALUATION AND MANAGEMENT OF ADULT PATIENTS WITH ACUTE MYELOID LEUKEMIA

##### History

Increasing fatigue or decreased exercise tolerance (anemia)  
 Excess bleeding or bleeding from unusual sites (DIC, thrombocytopenia)  
 Fevers or recurrent infections (granulocytopenia)  
 Headache, vision changes, nonfocal neurologic abnormalities (CNS leukemia or bleed)  
 Early satiety (splenomegaly)  
 Family history of AML (Fanconi's, Bloom's, or Kostmann's syndromes or ataxia telangiectasia)  
 History of cancer (exposure to alkylating agents, radiation, topoisomerase II inhibitors)  
 Occupational exposures (radiation, benzene, petroleum products, paint, smoking, pesticides)

##### Physical Examination

Performance status (prognostic factor)  
 Ecchymosis and oozing from IV sites (DIC, possible acute promyelocytic leukemia)  
 Fever and tachycardia (signs of infection)  
 Papilledema, retinal infiltrates, cranial nerve abnormalities (CNS leukemia)  
 Poor dentition, dental abscesses  
 Gum hypertrophy (leukemic infiltration, most common in monocytic leukemia)  
 Skin infiltration or nodules (leukemia infiltration, most common in monocytic leukemia)  
 Lymphadenopathy, splenomegaly, hepatomegaly  
 Back pain, lower extremity weakness [spinal granulocytic sarcoma, most likely in t(8;21) patients]

#### Laboratory and Radiologic Studies

CBC with manual differential cell count  
 Chemistry tests (electrolytes, creatinine, BUN, calcium, phosphorus, uric acid, hepatic enzymes, bilirubin, LDH, amylase, lipase)  
 Clotting studies (prothrombin time, partial thromboplastin time, fibrinogen, D-dimer)  
 Viral serologies (CMV, HSV-1, varicella zoster)  
 RBC type and screen  
 HLA typing of patient, siblings, and parents for potential allogeneic SCT  
 Bone marrow aspirate and biopsy (morphology, cytogenetics, flow cytometry, molecular studies)  
 Cryopreservation of viable leukemia cells  
 Echocardiogram or heart scan  
 PA and lateral chest radiograph  
 Placement of central venous access device

#### Interventions for Specific Patients

Dental evaluation (for those with poor dentition)  
 Lumbar puncture (for those with symptoms of CNS involvement)  
 Screening spine MRI (for patients with back pain, lower extremity weakness, paresthesias)  
 Social work referral for patient and family psychosocial support

#### Counseling for All Patients

Provide patient with information regarding his or her disease, financial counseling, and support group contacts

**Note:** BUN, blood urea nitrogen; CBC, complete blood count; CMV, cytomegalovirus; CNS, central nervous system; DIC, disseminated intravascular coagulation; HLA, human leukocyte antigen; HSV, herpes simplex virus; LDH, lactate dehydrogenase; MRI, magnetic resonance imaging; PA, posteroanterior; RBC, red blood (cell) count; SCT, stem cell transplant.

Most patients are anemic and thrombocytopenic at presentation. Replacement of the appropriate blood components, if necessary, should begin promptly. Because qualitative platelet dysfunction or the presence of an infection may increase the likelihood of bleeding, evidence of hemorrhage justifies the immediate use of platelet transfusion, even if the platelet count is only moderately decreased.

About 50% of patients have a mild to moderate elevation of serum uric acid at presentation. Only 10% have marked elevations, but renal precipitation of uric acid and the nephropathy that may result is a serious but uncommon complication. The initiation of chemotherapy may aggravate hyperuricemia, and patients are usually started immediately on allopurinol and hydration at diagnosis. Rasburicase (recombinant uric oxidase) is also useful for treating uric acid nephropathy and often can normalize the serum uric acid level within hours with a single dose of treatment. The presence of high concentrations of lysozyme, a marker for monocytic differentiation, may be etiologic in renal tubular dysfunction, which could

worsen other renal problems that arise during the initial phases of therapy.

## PROGNOSTIC FACTORS

Many factors influence the likelihood of entering CR, the length of CR, and the curability of AML. CR is defined after examination of both blood and bone marrow. The blood neutrophil count must be  $\geq 1000/\mu\text{L}$  and the platelet count  $\geq 100,000/\mu\text{L}$ . Hemoglobin concentration is not considered in determining CR. Circulating blasts should be absent. Although rare blasts may be detected in the blood during marrow regeneration, they should disappear on successive studies. Bone marrow cellularity should be  $>20\%$  with trilineage maturation. The bone marrow should contain  $<5\%$  blasts, and Auer rods should be absent. Extramedullary leukemia should not be present. For patients in morphologic CR, reverse transcriptase polymerase chain reaction (RT-PCR) to detect AML-associated molecular abnormalities and either metaphase cytogenetics or interphase cytogenetics by fluorescence in situ hybridization (FISH) to detect AML-associated cytogenetic aberrations are currently used to detect residual disease. Such detection of minimal residual disease may become a reliable discriminator between patients in CR who do or do not require additional and/or alternative therapies.

Age at diagnosis is among the most important risk factors. Advancing age is associated with a poorer prognosis, in part because of its influence on the patient's ability to survive induction therapy. Age also influences outcome because AML in older patients differs biologically. The leukemic cells in elderly patients more commonly express CD34 and the multidrug resistance 1 (MDR1) efflux pump that conveys resistance to natural product-derived agents such as the anthracyclines (see later). With each successive decade of age, a greater proportion of patients have more resistant disease. Chronic and intercurrent diseases impair tolerance to rigorous therapy; acute medical problems at diagnosis reduce the likelihood of survival. Performance status, independent of age, also influences ability to survive induction therapy and thus respond to treatment.

Chromosome findings at diagnosis are important independent prognostic factors. Patients with  $t(15;17)$  have a very good prognosis ( $\sim 85\%$  cured), and those with  $t(8;21)$  and  $inv(16)$  a good prognosis ( $\sim 50\%$  cured); those with no cytogenetic abnormality have a moderately favorable outcome ( $\sim 40\%$  cured). Patients with a complex karyotype,  $t(6;9)$ ,  $inv(3)$ , or 7 have a very poor prognosis. This emphasizes the importance of cytogenetic as well as the previously discussed molecular assessment of the leukemia cells at diagnosis and relevance of storing samples for potential later use.

A prolonged symptomatic interval with cytopenias preceding diagnosis or a history of an antecedent hematologic

disorder is another pretreatment clinical feature associated with a lower CR rate and shorter survival time. The CR rate is lower in patients who have had anemia, leukopenia, and/or thrombocytopenia for  $>3$  months before the diagnosis of AML when compared to those without such a history. Responsiveness to chemotherapy declines as the duration of the antecedent disorder(s) increases. Secondary AML developing after treatment with cytotoxic agents for other malignancies is usually difficult to treat successfully.

A high presenting leukocyte count is an independent prognostic factor for attaining a CR. Among patients with hyperleukocytosis ( $>100,000/\mu\text{L}$ ), early central nervous system bleeding and pulmonary leukostasis contribute to poor outcome with initial therapy.

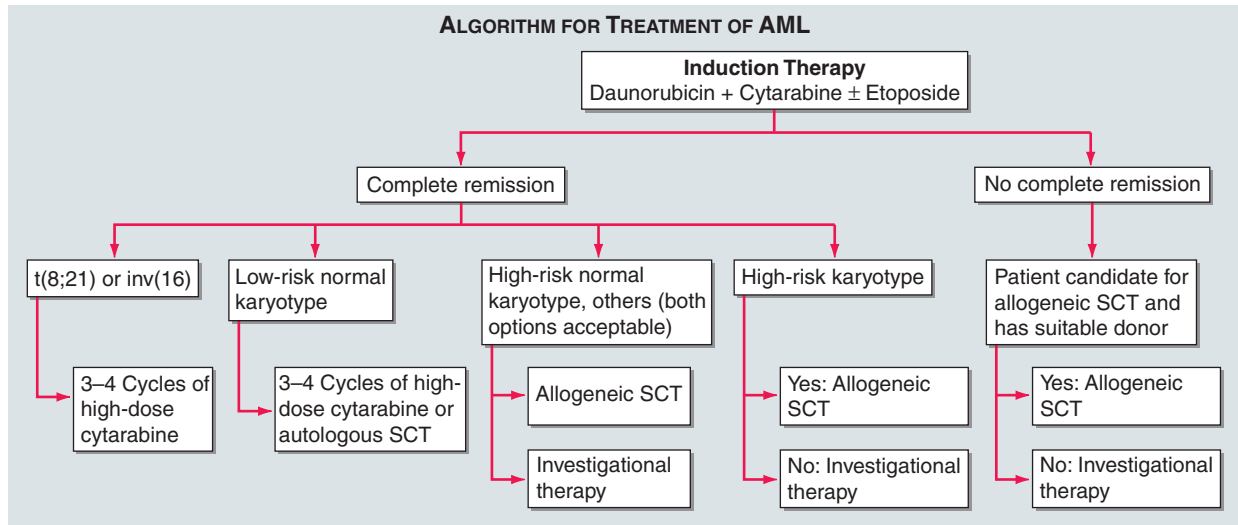
In addition to pretreatment variables such as age, cytogenetics, and leukocyte count, several treatment factors correlate with prognosis in AML, including, most importantly, achievement of CR. In addition, patients who achieve CR after one induction cycle have longer CR durations than those requiring multiple cycles.

### **Rx** Treatment: **ACUTE MYELOID LEUKEMIA**

Treatment of the newly diagnosed patient with AML is usually divided into two phases, induction and postremission management (Fig. 14-2). The initial goal is to induce CR quickly. Once CR is obtained, further therapy must be used to prolong survival and achieve cure. The initial induction treatment and subsequent postremission therapy are often chosen based on the patient's age. The influence of intensifying therapy with traditional chemotherapy agents such as cytarabine and anthracyclines in younger patients ( $<60$  years) appears to increase the cure rate of AML. In older patients the benefit of intensive therapy is controversial; novel therapies are being pursued.

**INDUCTION CHEMOTHERAPY** The most commonly used CR induction regimens (for patients other than those with APL) consist of combination chemotherapy with cytarabine and an anthracycline. Cytarabine is a cell cycle S-phase-specific antimetabolite that becomes phosphorylated intracellularly to an active triphosphate form that interferes with DNA synthesis. Anthracyclines are DNA intercalators. Their primary mode of action is thought to be inhibition of topoisomerase II, leading to DNA breaks. Cytarabine is usually administered as a continuous intravenous infusion for 7 days. Anthracycline therapy generally consists of daunorubicin intravenously on days 1, 2, and 3 (the 7 and 3 regimen). Treatment with idarubicin for 3 days in conjunction with cytarabine by 7-day continuous infusion is at least as effective and may be superior to daunorubicin in younger patients. The addition of etoposide may improve the CR duration.

After induction chemotherapy, the bone marrow is examined to determine if the leukemia has been

**FIGURE 14-2**

**Flow chart for the therapy of newly diagnosed acute myeloid leukemia.** For all forms of AML except acute promyelocytic leukemia (APL), standard therapy includes a 7-day continuous infusion of cytarabine (100–200 mg/m<sup>2</sup> per day) and a 3-day course of daunorubicin (45–60 mg/m<sup>2</sup> per day) or idarubicin (12–13 mg/m<sup>2</sup> per day) with or without 3 days of etoposide. Patients who achieve complete remission undergo postremission consolidation therapy, including sequential courses of high-dose cytarabine, autologous stem

cell transplant (SCT), high-dose combination chemotherapy with allogeneic SCT, or novel therapies, based on their predicted risk of relapse (i.e., risk-stratified therapy). Patients with APL usually receive tretinoin together with anthracycline chemotherapy for remission induction and then consolidation chemotherapy (daunorubicin) followed by maintenance tretinoin, with or without chemotherapy. The role of cytarabine in APL induction and consolidation is controversial.

eliminated. If  $\geq 5\%$  blasts exist with  $\geq 20\%$  cellularity, the patient is usually retreated with cytarabine and an anthracycline in doses similar to those given initially, but for 5 and 2 days, respectively. Our recommendation, however, is to change therapy in this setting. Patients who fail to attain CR after two induction courses should immediately proceed to an allogeneic stem cell transplant (SCT) if an appropriate donor exists. This approach is only applied to patients  $< 70$  years of age with acceptable end-organ function.

With the 7 and 3 cytarabine/daunorubicin regimen just outlined, 65–75% of adults with de novo AML  $< 60$  years of age achieve CR. Two-thirds achieve CR after a single course of therapy, and one-third require two courses. About 50% of patients who do not achieve CR have a drug-resistant leukemia, and 50% do not achieve CR because of fatal complications of bone marrow aplasia or impaired recovery of normal stem cells. Higher induction treatment-related mortality and frequency of resistant disease have been observed with increasing age and in patients with prior hematologic disorders (MDS or myeloproliferative syndromes) or chemotherapy treatment for another malignancy.

High-dose cytarabine-based regimens have very high CR rates after a single cycle of therapy. When given in high doses, more cytarabine may enter the cells, saturate the cytarabine-inactivating enzymes, and increase

the intracellular levels of 1- $\beta$ -D-arabinofuranylcytosine-triphosphate, the active metabolite incorporated into DNA. Thus higher doses of cytarabine may increase the inhibition of DNA synthesis and thereby overcome resistance to standard-dose cytarabine. In two randomized studies, high-dose cytarabine with an anthracycline produced CR rates similar to those achieved with standard 7 and 3 regimens. However, the CR duration was longer after high-dose cytarabine than after standard-dose cytarabine.

The hematologic toxicity of high-dose cytarabine-based induction regimens has typically been greater than that associated with 7 and 3 regimens. Toxicity with high-dose cytarabine includes myelosuppression, pulmonary toxicity, and significant and occasionally irreversible cerebellar toxicity. All patients treated with high-dose cytarabine must be closely monitored for cerebellar toxicity. Full cerebellar testing should be performed before each dose, and further high-dose cytarabine should be withheld if evidence of cerebellar toxicity develops. This toxicity occurs more commonly in patients with renal impairment and in those  $> 60$  years of age. The increased toxicity observed with high-dose cytarabine has limited the use of this therapy in elderly AML patients.

**SUPPORTIVE CARE** Measures geared to supporting patients through several weeks of granulocytopenia

and thrombocytopenia are critical to the success of AML therapy. Patients with AML should be treated in centers expert in providing supportive measures.

Recombinant hematopoietic growth factors have been incorporated into clinical trials in AML. These trials have been designed to lower the infection rate after chemotherapy. Both G-CSF and granulocyte-macrophage colony-stimulating factor (GM-CSF) have reduced the median time to neutrophil recovery by an average of 5–7 days. This accelerated rate of neutrophil recovery, however, has not generally translated into significant reductions in infection rates or shortened hospitalizations. In most randomized studies, both G-CSF and GM-CSF have failed to improve the CR rate, disease-free survival, or overall survival. Although receptors for both G-CSF and GM-CSF are present on AML blasts, therapeutic efficacy is neither enhanced nor inhibited by these agents. The use of growth factors as supportive care for AML patients is controversial. We favor their use in elderly patients with complicated courses, those receiving intensive postremission regimens, patients with uncontrolled infections, or those participating in clinical trials.

Multilumen right atrial catheters should be inserted as soon as patients with newly diagnosed AML have been stabilized. They should be used thereafter for administration of intravenous medications and transfusions, as well as for blood drawing. Antibiotic-impregnated catheters should be considered if the risk of line-related infection is high.

Adequate and prompt blood bank support is critical to therapy of AML. Platelet transfusions should be given as needed to maintain a platelet count  $>10,000$ – $20,000/\mu\text{L}$ . We believe that the platelet count should be kept at higher levels in febrile patients and during episodes of active bleeding or DIC. Patients with poor posttransfusion platelet count increments may benefit from administration of platelets from human leukocyte antigen (HLA)-matched donors. RBC transfusions should be administered to keep the hemoglobin level  $>80$  g/L (8 g/dL) in the absence of active bleeding, DIC, or congestive heart failure. Blood products leuko-depleted by filtration should be used to avert or delay alloimmunization as well as febrile reactions. Blood products should also be irradiated to prevent transfusion associated graft-versus-host disease (GVHD). Cytomegalovirus (CMV)-negative blood products should be used for CMV-seronegative patients who are potential candidates for allogeneic SCT. Leuko-depleted products are also effective for these patients if CMV-negative products are not available.

Infectious complications remain the major cause of morbidity and death during induction and postremission chemotherapy for AML. Prophylactic administration of antibiotics in the absence of fever is controversial. Oral nystatin or clotrimazole is recommended to prevent localized candidiasis. For patients who are herpes

simplex virus antibody titer-positive, acyclovir prophylaxis is effective in preventing reactivation of latent oral herpes infections.

Fever develops in most patients with AML, but infections are documented in only half of febrile patients. Early initiation of empirical broad-spectrum antibacterial and antifungal antibiotics has significantly reduced the number of patients dying of infectious complications (Chap. 28). An antibiotic regimen adequate to treat gram-negative organisms should be instituted at the onset of fever in a granulocytopenic patient after clinical evaluation, including a detailed physical examination with inspection of the indwelling catheter exit site and a perirectal examination, as well as procurement of cultures and radiographs aimed at documenting the source of fever. Specific antibiotic regimens should be based on antibiotic sensitivity data obtained from the institution at which the patient is being treated. Acceptable regimens include imipenem-cilastatin; an antipseudomonal semisynthetic penicillin (e.g., piperacillin) combined with an aminoglycoside; a third-generation cephalosporin with antipseudomonal activity (i.e., ceftazidime or cefepime); or double  $\beta$ -lactam combinations (ceftazidime and piperacillin). Aminoglycosides should be avoided if possible in patients with renal insufficiency. For patients with known immediate-type hypersensitivity reactions to penicillin, aztreonam may be substituted for  $\beta$ -lactams. Aztreonam should be combined with an aminoglycoside or a quinolone antibiotic rather than used alone.

Empirical vancomycin is not given initially in the absence of suspected gram-positive infection or mucositis but should be initiated in neutropenic patients who remain febrile for 3 days; empirical systemic antifungal therapy is added at 7 days if fever persists. Voriconazole has been shown to be equivalent in efficacy and less toxic than amphotericin-B. Caspofungin or liposomal amphotericin are also considered for fungal infections not responsive to first-line therapy or when such therapy is not tolerated. Antibacterial and antifungal antibiotics should be continued until patients are no longer neutropenic, regardless of whether a specific source has been found for the fever.

#### TREATMENT OF PROMYELOCYTIC LEUKEMIA

Tretinoin is an oral drug that induces the differentiation of leukemic cells bearing the  $t(15;17)$ . APL is responsive to cytarabine and daunorubicin, but  $\sim 10\%$  of patients treated with these drugs die from DIC induced by the release of granule components by dying tumor cells. Tretinoin does not produce DIC but produces another complication called the *retinoic acid syndrome*. Occurring within the first 3 weeks of treatment, it is characterized by fever, dyspnea, chest pain, pulmonary infiltrates, pleural and pericardial effusions, and hypoxia. The syndrome is related to adhesion of differentiated neoplastic cells to

the pulmonary vasculature endothelium. Glucocorticoids, chemotherapy, and/or supportive measures can be effective for management of the retinoic acid syndrome. The mortality of this syndrome is ~10%.

Tretinoin (45 mg/m<sup>2</sup> per day orally until remission is documented) plus concurrent anthracycline chemotherapy appears to be among the safest and most effective treatments for APL. Unlike patients with other types of AML, patients with this subtype benefit from maintenance therapy with either tretinoin or chemotherapy.

Arsenic trioxide produces meaningful responses in up to 85% of patients who are refractory to tretinoin. The use of arsenic trioxide is being explored as part of initial treatment in clinical trials of APL. Additionally, studies combining arsenic trioxide with tretinoin in the absence of chemotherapy are ongoing.

The detection of minimal residual disease by RT-PCR amplification of the t(15;17) chimeric gene product appears to predict relapse. Disappearance of the signal is associated with long-term disease-free survival; its persistence predicts relapse. With increases in the sensitivity of the assay, some patients with persistent abnormal gene product have been found who do not suffer a relapse. Studies are underway to determine whether a critical threshold level of transcripts uniformly predicts for leukemia relapse.

**POSTREMISSION THERAPY** Induction of a durable first CR is critical to long-term disease-free survival in AML. However, without further therapy virtually all patients experience relapse. Once relapse has occurred, AML is generally curable only by SCT.

Postremission therapy is designed to eradicate residual leukemic cells to prevent relapse and prolong survival. Postremission therapy in AML is often based on age (<55–65 years and >55–65 years). For younger patients, most studies include intensive chemotherapy and allogeneic or autologous SCT. High-dose cytarabine is more effective than standard-dose cytarabine. The Cancer and Leukemia Group B (CALGB), for example, compared the duration of CR in patients randomly assigned postremission to four cycles of high (3 g/m<sup>2</sup>, every 12 h on days 1, 3, and 5), intermediate (400 mg/m<sup>2</sup> for 5 days by continuous infusion), or standard (100 mg/m<sup>2</sup> per day for 5 days by continuous infusion) doses of cytarabine. A dose-response effect for cytarabine in patients with AML who were ≤60 years of age was demonstrated. High-dose cytarabine significantly prolonged CR and increased the fraction cured in patients with favorable [t(8;21) and inv(16)] and normal cytogenetics, but it had no significant effect on patients with other abnormal karyotypes. For older patients, exploration of attenuated intensive therapy that includes either chemotherapy or reduced intensity allogeneic SCT

has been pursued. Postremission therapy is a setting for introduction of new agents (Table 14-3).

Allogeneic SCT is used in patients <70 years of age with an HLA-compatible donor who have high-risk cytogenetics. In the subset with normal cytogenetics and high-risk molecular features such as *FLT3* ITD, allogeneic SCT is best applied in the context of clinical trials because the impact of aggressive therapy on outcome is unknown. Relapse following allogeneic SCT occurs in only a small fraction of patients, but toxicity is relatively high from treatment; complications include venoocclusive disease, GVHD, and infections. Autologous transplantation can be administered in young and older patients and uses the same preparative regimens. Patients subsequently receive their own stem cells collected while in remission. The toxicity is lower with autologous SCT (5% mortality rate), but the relapse rate is higher than with allogeneic SCT, and randomized studies have not demonstrated outcome superior to postremission conventional-dose chemotherapy. The increased relapse rate is due to the absence of the graft-versus-leukemia (GVL) effect seen with allogeneic SCT and possible contamination of the autologous stem cells with tumor cells. Purging tumor from the autologous stem cells has not lowered the relapse rate with autologous SCT.

**TABLE 14-3**

**SELECTED NEW AGENTS UNDER STUDY FOR TREATMENT OF ADULTS WITH AML**

CLASS OF DRUGS	EXAMPLE AGENT(S)
<i>MDR1</i> modulators	Cyclosporine, LY335979
Demethylating agents	Decitabine, 5-azacytidine, zebularine
Histone deacetylase inhibitors	Suberoylanilide hydroxamic acid (SAHA), MS275, LBH589, valproic acid
Heavy metals	Arsenic trioxide, antimony
Farnesyl transferase inhibitors	R115777, SCH66336
<i>FLT3</i> inhibitors	SU11248, PKC412, MLN518, CHIR-258
HSP-90 antagonists	17-allylaminogeldanamycin (17-AAG) or derivatives
BCR-ABL PDGFR/KIT inhibitors	Imatinib (ST1571, Gleevec), dasatinib, nilotinib
Telomerase inhibitor	GRN163L
Cell cycle inhibitors	Flavopiridol, CYC202 (R-Roscovitine), SNS-032
Nucleoside analogues	Clofarabine, troxacitabine
Humanized antibodies	Anti-CD33 (SGN33), anti-DR4, anti-DR5, anti-KiR
Toxin-conjugated antibodies	Gemtuzumab ozogamicin (Mylotarg)
Radiolabeled antibodies	Yttrium-90-labeled human M195

Randomized trials comparing intensive chemotherapy and autologous and allogeneic SCT have shown improved duration of remission with allogeneic SCT compared to autologous SCT or chemotherapy alone. However, overall survival is generally not different; the improved disease control with allogeneic SCT is erased by the increase in fatal toxicity. Whereas stem cells were previously harvested from the bone marrow, virtually all efforts currently collect these from the blood following mobilization regimens, including growth factors with or without chemotherapy. Prognostic factors may help select patients in first CR for whom transplant is most effective.

Our approach includes considering allogeneic SCT in first CR for patients with high-risk karyotypes. Patients with normal karyotypes who have other poor risk factors (e.g., an antecedent hematologic disorder, failure to attain remission with a single induction course, PTD of the *MLL* gene, ITD of the *FLT3* gene, overexpression of *BAALC*) are also potential candidates. If a suitable HLA donor does not exist, novel therapeutic approaches are considered. Other novel transplant strategies, including reduced-intensity SCT, are being explored for consolidation of high-risk AML patients. Patients with t(8;21) and inv(16) are treated with repetitive doses of high-dose cytarabine, which offers a high frequency of cure without the morbidity of transplant. In AML patients with t(8;21) and inv(16), those with *KIT* mutations may be considered for novel investigational studies.

Autologous SCT is generally applied to AML patients only in the context of a clinical trial or when the risk of repetitive intensive chemotherapy represents a higher risk than the autologous SCT (e.g., in patients with severe platelet alloimmunization).

**RELAPSE** Once relapse occurs, patients are rarely cured with further standard-dose chemotherapy. Patients eligible for allogeneic SCT should receive transplants expeditiously at the first sign of relapse. Long-term disease-free survival is approximately the same (30–50%) with allogeneic SCT in first relapse or in second remission. Autologous SCT rescues ~20% of relapsed patients with AML who have chemosensitive disease. The most important factors predicting response at relapse are the length of the previous CR, whether initial CR was achieved with one or two courses of chemotherapy, and the type of postremission therapy.

Because of the poor outcome of patients in early first relapse (<12 months), it is justified (for patients without HLA-compatible donors) to explore innovative approaches, such as new drugs or immunotherapies (Table 14-3). Patients with longer first CR (>12 months) generally relapse with drug-sensitive disease and have a higher chance of attaining a CR. However, cure is uncommon, and treatment with novel approaches

should be considered if SCT is not possible. One promising therapy is decitabine, a nucleoside analog that inhibits DNA methyltransferase and subsequently reverses aberrant methylation in AML cells. Interestingly, inhibiting DNA methyltransferase occurs at a much lower dose than previously used to produce a cytotoxic effect in AML. Low-dose decitabine yields CR in a small subset of patients with relapsed AML, including those with unfavorable karyotypes. New agents are needed.

For elderly patients (>60 years of age) for whom clinical trials are not available, gemtuzumab ozogamicin (Mylotarg) is another alternative. This therapy is an antibody-targeted chemotherapy consisting of the humanized anti-CD33 antibody linked to calicheamicin, a potent antitumor antibiotic. The CR rate is ~30%. Its effectiveness in early relapsing (<6 months) or refractory AML patients is limited, possibly due to calicheamicin being a potent MDR1 substrate. Toxicity, including myelosuppression, infusion toxicity, and venoocclusive disease, can be observed with gemtuzumab ozogamicin. Pretreatment with glucocorticoids can diminish many of the infusion reactions associated with gemtuzumab ozogamicin. Studies are examining this treatment in combination with chemotherapy for both young and older patients with previously untreated AML.

## CHRONIC MYELOGENOUS LEUKEMIA

### INCIDENCE

The incidence of chronic myelogenous leukemia (CML) is 1.5 per 100,000 people per year, and the age-adjusted incidence is higher in men than in women (2.0 versus 1.2). The incidence of CML increases slowly with age until the middle forties, when it starts to rise rapidly. CML incidence for males decreased slightly (4.4%) between 1997 and 2003 as compared to 1977–1997.

### DEFINITION

The diagnosis of CML is established by identifying a clonal expansion of a hematopoietic stem cell possessing a reciprocal translocation between chromosomes 9 and 22. This translocation results in the head-to-tail fusion of the breakpoint cluster region (*BCR*) gene on chromosome 22q11 with the *ABL* (named after the Abelson murine leukemia virus) gene located on chromosome 9q34. Untreated, the disease is characterized by the inevitable transition from a chronic phase to an accelerated phase and on to blast crisis in a median time of 4 years.

### ETIOLOGY

No clear correlation with exposure to cytotoxic drugs has been found, and no evidence suggests a viral etiology. In the pre-imatinib era, cigarette smoking accelerated the



176 progression to blast crisis and therefore adversely affected survival in CML. Atomic bomb survivors had an increased incidence; the development of a CML cell mass of 10,000/ $\mu$ L took 6.3 years. No increase in CML incidence was found in the survivors of the Chernobyl accident, suggesting that only large doses of radiation can induce CML.

## PATHOPHYSIOLOGY

The product of the fusion gene resulting from the t(9;22) plays a central role in the development of CML. This chimeric gene is transcribed into a hybrid *BCR/ABL* mRNA in which exon 1 of *ABL* is replaced by variable numbers of 5' *BCR* exons. Bcr/Abl fusion proteins, p210<sup>*BCR/ABL*</sup>, are produced that contain NH<sub>2</sub>-terminal domains of Bcr and the COOH-terminal domains of Abl. A rare breakpoint, occurring within the 3' region of the *BCR* gene, yields a fusion protein of 230 kDa, p230<sup>*BCR/ABL*</sup>. Bcr/Abl fusion proteins can transform hematopoietic progenitor cells in vitro. Furthermore, reconstituting lethally irradiated mice with bone marrow cells infected with retrovirus carrying the gene encoding the p210<sup>*BCR/ABL*</sup> leads to the development of a myeloproliferative syndrome resembling CML in 50% of the mice. Specific antisense oligomers to the *BCR/ABL* junction inhibit the growth of t(9;22)-positive leukemic cells without affecting normal colony formation.

The mechanism(s) by which p210<sup>*BCR/ABL*</sup> promotes the transition from the benign state to the fully malignant one is still unclear. Messenger RNA for *BCR/ABL* can occasionally be detected in normal individuals. However, attachment of the *BCR* sequences to *ABL* results in three critical functional changes: (1) the Abl protein becomes constitutively active as a tyrosine kinase (TK) enzyme, activating downstream kinases that prevent apoptosis; (2) the DNA-protein-binding activity of Abl is attenuated; and (3) the binding of Abl to cytoskeletal actin microfilaments is enhanced.

## Disease Progression

The events associated with transition to the acute phase, a common occurrence in the pre-imatinib era, were extensively studied. Chromosomal instability of the malignant clone, resulting, for example, in the acquisition of an additional t(9;22), trisomy 8, or 17p- (p53 loss), is a basic feature of CML. Acquisition of these additional genetic and/or molecular abnormalities is critical to the phenotypic transformation. Large deletions adjacent to the translocation breakpoint on the derivative 9 chromosome, detected by microsatellite polymerase chain reaction (PCR) or FISH, are associated with shorter survival times. Heterogeneous structural alterations of the p53 gene, as well as structural alterations and lack of protein production of the retinoblastoma gene and the catalytic component of

telomerase, have been associated with disease progression in a subset of patients. Rare patients show alterations in the rat sarcoma viral oncogene homolog (*RAS*). Sporadic reports also document the presence of an altered *MYC* (named after the myelocytomatosis virus) gene. Progressive de novo DNA methylation at the *BCR/ABL* locus and hypomethylation of the *LINE-1* retrotransposon promoter herald blastic transformation. Further, interleukin 1 $\beta$  may be involved in the progression of CML to the blastic phase. In addition, functional inactivation of the tumor suppressor protein phosphatase A2 may be required for blastic transformation. Finally, CML that develops resistance to imatinib is at an increased risk of progressing to accelerated/blast crisis. Multiple pathways to disease transformation exist, but the exact timing and relevance of each remain unclear.

## CLINICAL PRESENTATION

### Symptoms

The clinical onset of the chronic phase is generally insidious. Accordingly, some patients are diagnosed while still asymptomatic, during health-screening tests; other patients present with fatigue, malaise, and weight loss or have symptoms resulting from splenic enlargement, such as early satiety and left upper quadrant pain or mass. Less common are features related to granulocyte or platelet dysfunction, such as infections, thrombosis, or bleeding. Occasionally, patients present with leukostatic manifestations due to severe leukocytosis or thrombosis such as vasoocclusive disease, cerebrovascular accidents, myocardial infarction, venous thrombosis, priapism, visual disturbances, and pulmonary insufficiency. Patients with p230<sup>*BCR/ABL*</sup>-positive CML have a more indolent course.

Progression of CML is associated with worsening symptoms. Unexplained fever, significant weight loss, increasing dose requirement of the drugs controlling the disease, bone and joint pain, bleeding, thrombosis, and infections suggest transformation into accelerated or blastic phases. Fewer than 10–15% of newly diagnosed patients present with accelerated disease or with de novo blastic phase CML.

### Physical Findings

Minimal to moderate splenomegaly is the most common physical finding; mild hepatomegaly is found occasionally. Persistent splenomegaly despite continued therapy is a sign of disease acceleration. Lymphadenopathy and myeloid sarcomas are unusual except late in the course of the disease; when they are present, the prognosis is poor.

### Hematologic Findings

Elevated white blood cell counts (WBCs), with increases in both immature and mature granulocytes, are present

at diagnosis. Usually <5% circulating blasts and <10% blasts and promyelocytes are noted with most of the cells myelocytes, metamyelocytes, and band forms. Cycling of the counts may be observed in patients followed without treatment. Platelet counts are almost always elevated at diagnosis, and a mild degree of normocytic normochromic anemia is present. Leukocyte alkaline phosphatase is low in CML cells. Serum levels of vitamin B<sub>12</sub> and vitamin B<sub>12</sub>-binding proteins are elevated. Phagocytic functions are usually normal at diagnosis and remain normal during the chronic phase. Histamine production secondary to basophilia is increased in later stages, causing pruritus, diarrhea, and flushing.

At diagnosis, bone marrow cellularity is increased, with an increased myeloid to erythroid ratio. The marrow blast percentage is generally normal or slightly elevated. Marrow or blood basophilia, eosinophilia, and monocytosis may be present. Although collagen fibrosis in the marrow is unusual at presentation, significant degrees of reticulin stain-measured fibrosis are noted in about half of the patients.

*Disease acceleration* is defined by the development of increasing degrees of anemia unaccounted for by bleeding or therapy; cytogenetic clonal evolution; or blood or marrow blasts between 10% and 20%, blood or marrow basophils  $\geq 20\%$ , or platelet count  $< 100,000/\mu\text{L}$ . *Blast crisis* is defined as acute leukemia, with blood or marrow blasts  $\geq 20\%$ . Hyposegmented neutrophils may appear (Pelger-Huet anomaly). Blast cells can be classified as myeloid, lymphoid, erythroid, or undifferentiated, based on morphologic, cytochemical, and immunologic features. Occurrence of de novo blast crisis or following imatinib therapy is rare.

### Chromosomal Findings

The cytogenetic hallmark of CML, found in 90–95% of patients, is the  $t(9;22)(q34;q11.2)$ . Originally, this was recognized by the presence of a shortened chromosome 22 (22q-), designated as the *Philadelphia chromosome*, that arises from the reciprocal  $t(9;22)$ . Some patients may have complex translocations (designated as *variant translocations*) involving three, four, or five chromosomes (usually including chromosomes 9 and 22). However, the molecular consequences of these changes are similar to those resulting from the typical  $t(9;22)$ . All patients should have evidence of the translocation molecularly or by cytogenetics or FISH to make a diagnosis of CML.

### PROGNOSTIC FACTORS

The clinical outcome of patients with CML is variable. Before imatinib mesylate, death was expected in 10% of patients within 2 years and in ~20% yearly thereafter, and the median survival time was ~4 years. Therefore, several prognostic models that identify different risk

groups in CML were developed. The most commonly used staging systems have been derived from multivariate analyses of prognostic factors. The *Sokal index* identified percentage of circulating blasts, spleen size, platelet count, age, and cytogenetic clonal evolution as the most important prognostic indicators. This system was developed based on chemotherapy-treated patients. The *Hasford system* was developed on interferon (IFN)- $\alpha$ -treated patients. It identified percentage of circulating blasts, spleen size, platelet count, age, and percentage of eosinophils and basophils as the most important prognostic indicators. This system differs from the Sokal index by ignoring clonal evolution and incorporating percentage of eosinophils and basophils. When applied to a data set of 272 patients treated with IFN- $\alpha$ , the Hasford system was better than the Sokal score for predicting survival time; it identified more low-risk patients but left only a small number of cases in the high-risk group. Preliminary results suggest that both the Sokal and the Hasford systems are applicable to imatinib-treated patients.

#### **Rx Treatment:** **CHRONIC MYELOGENOUS LEUKEMIA**

The therapy of CML is changing rapidly because we have a proven curative treatment (allogeneic transplantation) that has significant toxicity and a new targeted treatment (imatinib) with excellent outcome based on 5-year follow-up data. Therefore, physician experience and patient preference must be factored into the treatment selection process. Discussion of both treatment options with a patient is indicated. The decision should focus on the outcomes, risks, and toxicities of the various approaches.

At present, the goal of therapy in CML is to achieve prolonged, durable, nonneoplastic, nonclonal hematopoiesis, which entails the eradication of any residual cells containing the *BCR/ABL* transcript. Hence the goal is complete molecular remission and cure. A proposed imatinib treatment algorithm for the newly diagnosed CML patient is presented in [Table 14-4](#).

**ALLOGENEIC SCT** Allogeneic SCT is complicated by early mortality owing to the transplant procedure. Outcome of SCT depends on multiple factors including (1) the patient (e.g., age and phase of disease); (2) the type of donor [e.g., syngeneic (monozygotic twins) or HLA-compatible allogeneic, related or unrelated]; (3) the preparative regimen (myeloablative or reduced intensity); (4) GVHD; and (5) posttransplantation treatment.

**The Patient** Patients should have acceptable end-organ function, be <70 years of age, and have a healthy, histocompatible donor. Furthermore, survival after SCT in the accelerated and blastic phases of the disease is

## IMATINIB TREATMENT MILESTONES FOR NEWLY DIAGNOSED CML PATIENTS

Proposed Course of Action <sup>a</sup>		
	Transplantation from an HLA-compatible (related or unrelated) donor, dasatinib, new drugs	Continue same <sup>b</sup> or increase dose <sup>c</sup>
Time, mo	Milestones	
3	No complete hematologic remission	Complete hematologic remission <sup>b,d</sup>
6	No cytogenetic remission	Any cytogenetic remission <sup>e</sup>
12	Minor <sup>e</sup> or no cytogenetic remission	Complete <sup>b,f</sup> or partial <sup>c,g</sup> cytogenetic remission
18	Partial, minor, or no cytogenetic remission	Complete cytogenetic remission <sup>b</sup>
Anytime	Loss of previously achieved hematologic, cytogenetic, or molecular remission	

<sup>a</sup>Nutritional Comprehensive Cancer Network, Chronic myelogenous leukemia.

<sup>b</sup>Denotes that at the indicated milestones, patients should stay on the same dose.

<sup>c</sup>Denotes that at the indicated milestones, for patients on 400 mg/d, one can either continue the same or increase the dose to a maximum of 600–800 mg, as tolerated.

<sup>d</sup>Complete hematologic remission, WBC <10,000/μL, normal blood morphology, hemoglobin and platelet counts, and disappearance of splenomegaly.

<sup>e</sup>Minor cytogenetic remission, 36–85% bone marrow metaphases with t(9;22).

<sup>f</sup>Complete cytogenetic remission, no bone marrow metaphases with t(9;22).

<sup>g</sup>Partial cytogenetic remission, 1–35% bone marrow metaphases with t(9;22).

**Note:** HLA, human leukocyte antigen; WBC, white blood cell count.

significantly diminished and is associated with high rates of relapse. Bone marrow transplantation (BMT) early in the chronic phase (1–2 years from diagnosis) is superior to later BMT. In the imatinib era, allogeneic transplantation should be used when possible for patients with accelerated/blastic phases of the disease or those whose disease fails to respond or progresses on imatinib.

**The Donor** Transplantation from a family donor, who is either fully matched or mismatched at only one HLA locus, should be considered for any patient with CML who is a candidate for an HLA-related sibling transplant. Syngeneic BMT in patients with chronic-phase CML results in 7-year disease-free survival in 55% of patients, with a 30% relapse rate. BMT with an HLA-identical sibling in the chronic phase achieves 5-year disease-free survival in 40–70% of patients, with a 25% relapse rate. BMT from an HLA-matched unrelated donor in chronic phase <1 year from diagnosis and <30 years of age results in 5-year disease-free survival similar to matched-sibling donor transplantation. For all other groups, patients receiving BMT from unrelated donors have higher rates of graft failure and acute and chronic GVHD and prolonged convalescence after treatment, compared to those who receive allogeneic transplants from related donors.

Sex mismatch has an adverse effect on transplantation, with worse outcome associated with a female donor and male recipient. This has been attributed to GVHD against the male histocompatibility Y antigen.

Peripheral blood is now being studied as a source of hematopoietic progenitor cells; it may offer rapid engraftment and less risk for the donor. With unrelated donors, some studies demonstrated no difference in GVHD and improved disease-free survival when comparing peripheral blood to bone marrow stem cells. Using matched sibling donors in chronic-phase CML, marrow stem cells led to a higher cumulative incidence of relapse at 3 years; peripheral blood stem cell recipients had a higher cumulative incidence of chronic GVHD. At the current time, some centers collect bone marrow and some peripheral blood from sibling donors for newly diagnosed chronic-phase CML patients. Patients with more advanced stages are offered peripheral blood SCT. Umbilical-cord blood may permit mismatched SCT with notably less GVHD; GVL effects do not appear to be impaired. A problem with cord blood is obtaining a sufficient number of progenitor cells to reconstitute hematopoiesis in an adult.

**Preparative Regimens** Several groups have studied myeloablative regimens. Cyclophosphamide plus total-body irradiation is comparable to busulphan plus cyclophosphamide in the 3-year probabilities of survival, relapse, event-free survival, speed of engraftment, and incidence of venoocclusive disease of the liver. Significantly more patients in the total-body irradiation arm experienced major elevations of creatinine, acute GVHD, longer periods of fever, positive blood cultures, hospital admissions, and longer inpatient hospital stays.

However, increased chronic GVHD, obstructive bronchiolitis, and alopecia were noted with busulphan. Measurement of busulphan levels revealed no significant association between busulphan levels and regimen-related toxicity, but low levels were associated with an increased risk of relapse. Intravenous busulphan allows better control of serum levels.

Numerous groups have reported reduced-intensity transplants in which the preparative regimen is aimed at eliminating host lymphocytes rather than bone marrow. No randomized trials comparing the two approaches have been published. Retrospective comparisons reveal that reduced-intensity conditioning regimens produce equivalent or acceptable results (in toxicity as well as outcome). Reduced toxicity with preserved antitumor efficacy is the goal, and therefore reduced-intensity transplantation is our recommendation.

**Development and Type of GVHD** Development of grade I GVHD (Chap. 29) decreases the risk of relapse compared to no GVHD. An even lower relapse rate was observed in patients with grade II GVHD but was accompanied by a substantially higher transplant-related mortality rate. The decreased relapse rate may be caused by a GVL effect. Depletion of T lymphocytes from donor marrow can prevent GVHD but results in an increased risk of relapse, which exceeds the relapse rate after syngeneic SCT. Thus T lymphocytes from the donor marrow mediate a significant antileukemic or GVL effect, and even syngeneic marrow may exhibit limited GVL activity in CML.

**Posttransplantation Treatment** *BCR/ABL* transcript levels have served as early predictors for hematologic relapse following transplantation. These should facilitate risk-adapted approaches with immunosuppression or TK inhibitor(s), or a combination of the two. Donor leukocyte infusions (without any preparative chemotherapy or GVHD prophylaxis) can induce hematologic and cytogenetic remissions in patients with CML who have relapsed after allogeneic SCT.

Imatinib can control CML that has recurred after allogeneic SCT but is sometimes associated with myelosuppression and recurrence of severe GVHD. Imatinib after allogeneic SCT is being studied for prevention of relapse in patients with advanced disease at the time of transplantation (i.e., patients at high risk for relapse), patients undergoing reduced-intensity transplants, or patients with slow reduction of *BCR/ABL* message following transplantation. Imatinib has also been combined with donor lymphocytes to induce rapid molecular remissions in CML patients with disease relapse after allogeneic SCT. Of interest are studies with newer TK inhibitors following transplantation for imatinib-resistant CML.

**IMATINIB MESYLATE** Imatinib mesylate (Gleevec) functions through competitive inhibition at the ATP

binding site of the Abl kinase in the inactive conformation, which leads to inhibition of tyrosine phosphorylation of proteins involved in Bcr/Abl signal transduction. It shows specificity for Bcr/Abl, the receptor for platelet-derived growth factor, and Kit tyrosine kinases. Imatinib induces apoptosis in cells expressing Bcr/Abl.

In newly diagnosed CML, imatinib (400 mg/d) is more effective than IFN- $\alpha$  and cytarabine. The complete hematologic remission rate, at 18 months, of patients treated with imatinib was 97% compared to 69% in patients treated with IFN- $\alpha$  and cytarabine. Similarly, the complete cytogenetic remission rate was 76% with imatinib compared to 14% with IFN- $\alpha$  and cytarabine.

All imatinib-treated patients who achieved major molecular remission (26%), defined as  $\geq 3$  log reduction in *BCR/ABL* transcript level at 18 months compared to pretreatment level, were progression-free at 5 years. The progression-free survival (PFS) at 5 years for patients achieving complete cytogenetic remission but less pronounced molecular remission is 98%. The 5-year PFS for patients not achieving complete cytogenetic remission at 18 months was 87%. These results have led to a consensus that molecular responses can be used as a treatment goal in CML. Specific milestones have been developed for chronic-phase CML patients (Table 14-4). For example, chronic-phase CML patients who do not achieve any cytogenetic remission following 6 months of imatinib are unlikely to achieve major molecular remission and should be offered other treatment approaches.

Progression to accelerated/blastic phases of the disease was noted in 3% of patients treated with imatinib as compared to 8.5% of patients treated with IFN- $\alpha$  and cytarabine during the first year. Over time, the annual incidence of disease progression on imatinib decreased gradually to <1% during the fourth and fifth years, and no patient who achieved complete cytogenetic remission during the first year of imatinib treatment progressed to the accelerated/blastic phases of the disease.

Imatinib is administered orally. The main side effects are fluid retention, nausea, muscle cramps, diarrhea, and skin rashes. The management of these side effects is usually supportive. Myelosuppression is the most common hematologic side effect. Myelosuppression, although rare, may require holding drug and/or growth factor support. Doses <300 mg/d seem ineffective and may lead to development of resistance.

Four mechanisms of resistance to imatinib have been described to date. These are (1) gene amplification, (2) mutations at the kinase site, (3) enhanced expression of multidrug exporter proteins, and (4) alternative signaling pathways functionally compensating for the imatinib-sensitive mechanisms. All four mechanisms are being targeted in clinical trials.

*BCR/ABL* gene amplification and decreased intracellular imatinib concentrations are addressed by intensifying

the therapy with higher (up to 800 mg/d) imatinib doses. Response in some patients has led to early intensification of imatinib dosage in newly diagnosed CML patients, resulting in improved major molecular remissions when retrospectively compared to controls treated with 400 mg/d. Randomized studies comparing 400 mg/d doses to 800 mg/d in newly diagnosed CML patients are ongoing.

Mutations at the kinase domain are being targeted by novel TK inhibitors that have a different conformation than imatinib, demonstrating activity against most imatinib-resistant mutations. Nilotinib (Tasigna), like imatinib, binds to the kinase domain in the inactive conformation. Dasatinib (Sprycel) binds to the kinase domain in the open conformation and also inhibits the SRC (sarcoma) family of kinases, addressing the last mechanism of resistance. CML with the T315I mutation is resistant to imatinib, nilotinib, and dasatinib.

Dasatinib is approved by the FDA for the treatment of all stages of CML with resistance or intolerance to prior therapy, including imatinib. Nilotinib will likely follow suit. Both are oral agents given twice daily, with toxicity profiles similar to imatinib with small but significant differences. Dasatinib was shown to cause pleural effusion in 22% of patients with 7% developing grade 3–4 toxicity. Nilotinib was associated with sudden death in 6 of ~550 CML patients. A suspected relationship to nilotinib was reported in two of these cases.

These new agents have changed the treatment algorithm of CML. For example, patients who do not achieve any cytogenetic remission at 6 months on imatinib will now be offered either dasatinib or SCT. IFN- $\alpha$ , though FDA-approved for CML, will only be offered if all other options have failed.

The encouraging results with imatinib have led clinicians to offer it as first-line therapy for newly diagnosed CML patients, including those who otherwise would have benefited from transplant (e.g., young patients with a matched sibling donor). Prior exposure to imatinib does not affect transplant outcome. However, delaying BMT for high-risk patients (Sokal/Hasford criteria) may result in disease progression. SCT after disease progression is associated with poorer outcome. Therefore, we recommend close monitoring of imatinib response, especially in these patients (Table 14-4).

**INTERFERON** Before imatinib, when allogeneic SCT was not feasible, IFN- $\alpha$  therapy was the treatment of choice. Only longer follow-up of patients treated with imatinib will prove whether IFN- $\alpha$  will still have a role in the treatment of CML. Its mode(s) of action in CML is still unknown.

**CHEMOTHERAPY** Initial management of patients with chemotherapy is currently reserved for rapid lowering of WBCs, reduction of symptoms, and reversal of

symptomatic splenomegaly. Hydroxyurea, a ribonucleotide reductase inhibitor, induces rapid disease control. The initial dose is 1–4 g/d; the dose should be halved with each 50% reduction of the leukocyte count. Unfortunately, cytogenetic remissions with hydroxyurea are uncommon. Busulphan, an alkylating agent that acts on early progenitor cells, has a more prolonged effect. However, we do not recommend its use because of its serious side effects, which include unexpected, and occasionally fatal, myelosuppression in 5–10% of patients; pulmonary, endocardial, and marrow fibrosis; and an Addison-like wasting syndrome.

**AUTOLOGOUS SCT** Autologous SCT could potentially cure CML if a means to select the residual normal progenitors, which coexist with their malignant counterparts, could be developed. As a source of autologous hematopoietic stem cells for transplantation, blood offers certain advantages over marrow (e.g., faster engraftment for the patient and no general anesthesia for the donor). Normal hematopoietic stem cells appear with increased frequency in the blood of patients with CML during the recovery phase after chemotherapy and G-CSF. A role for imatinib before stem cell collection to achieve minimal residual disease and following transplantation to maintain this status is currently being investigated. Specifically, several groups store peripheral blood stem cells from patients in major or complete molecular remissions. However, only a few cases have been transplanted following imatinib therapy. Therefore, such approaches should be performed only in clinical trials.

**LEUKAPHERESIS AND SPLENECTOMY** Intensive leukapheresis may control the blood counts in chronic-phase CML; however, it is expensive and cumbersome. It is useful in emergencies where leukostasis-related complications such as pulmonary failure or cerebrovascular accidents are likely. It may also have a role in the treatment of pregnant women in whom it is important to avoid potentially teratogenic drugs.

Splenectomy was used in CML in the past because of the suggestion that evolution to the acute phase might occur in the spleen. However, this does not appear to be the case, and splenectomy is now reserved for symptomatic relief of painful splenomegaly unresponsive to imatinib or chemotherapy, or for significant anemia or thrombocytopenia associated with hypersplenism. Splenic radiation is used rarely to reduce the size of the spleen.

**MINIMAL RESIDUAL DISEASE** The kinetics of *BCR/ABL* transcript elimination are currently replacing qualitative detection of the *BCR/ABL* message, in spite of a lack of standard acceptable methodology. A consensus panel has proposed ways to harmonize the different methods and to use a conversion factor so that individual

laboratories will be able to express *BCR/ABL* transcript levels on an agreed upon scale.

Slow reduction of *BCR/ABL* transcripts following SCT correlates with the possibility of hematologic relapse. However, the definition of "slow reduction" depends on the preparative regimen (reduced-intensity versus fully myeloablative) and the selection of time points to measure the transcript levels. Although persistent RT-PCR positivity at 6 months was regarded as an indication for additional therapy in the past, current studies utilize periods between engraftment and day 100 for evaluating the clearance rate of *BCR/ABL* transcripts and recommending additional therapies. Large trials with longer follow-up are needed to establish consensus guidelines.

The randomized trial of imatinib versus IFN- $\alpha$  and cytarabine was the first to establish the concept of  $\log_{10}$  reduction of *BCR/ABL* transcript from a standardized baseline for untreated patients. This measurement unit was developed instead of either the transcript numbers expressed per  $\mu\text{g}$  of leukocyte RNA or the ratio of *BCR/ABL* to a housekeeping gene on a log scale. In this randomized trial, patients who achieved  $\geq 3$  log reduction of *BCR/ABL* message had an extremely low probability of relapse, with a median follow-up of 60 months. It is unclear whether achieving complete molecular remission should still be the goal of treatment in this disease.

These studies also established the value and convenience of using peripheral blood instead of bone marrow testing as a means to assess disease status in patients who achieve complete cytogenetic responses. However, one still needs to consider following CML patients in complete cytogenetic remission and at least major molecular remission with annual cytogenetic bone marrow testing because these patients are at risk of developing cytogenetic aberrations in t(9;22)-negative cells and secondary MDS/AML. These aberrations in the t(9;22)-negative cells are frequently transient, and their clinical significance is unclear. Such aberrations may occur in 7–10% of imatinib-treated patients. Development of MDS/AML is rare.

**TREATMENT OF BLAST CRISIS** Treatments for primary blast crisis, including imatinib, are generally ineffective. Only 52% of patients treated with imatinib achieved hematologic remission (21% complete

hematologic remission), and the median overall survival was 6.6 months. Patients who achieve complete hematologic remission or whose disease returns to a second chronic phase should be considered for allogeneic SCT. Other approaches include induction chemotherapy tailored to the phenotype of the blast cell followed by imatinib, with or without additional chemotherapy and SCT. Blast crisis following initial therapy with imatinib carries a dismal prognosis even if treated with dasatinib or nilotinib.

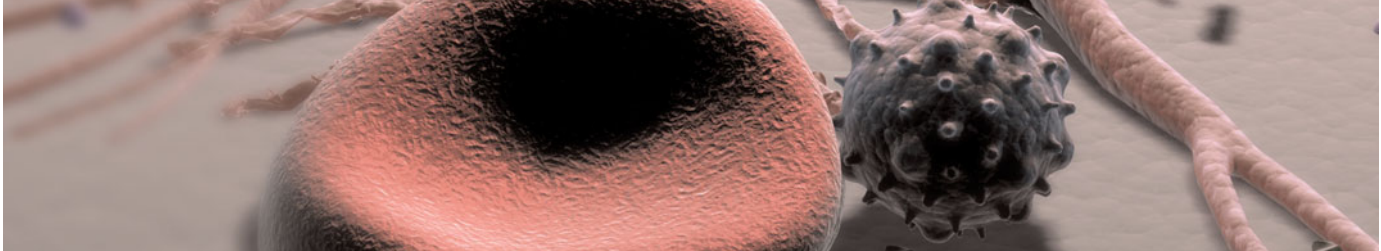
## FURTHER READINGS

### AML

- FROHLING S et al: Genetics of myeloid malignancies: Pathogenetic and clinical implications. *J Clin Oncol* 23:6285, 2005
- KORETH J et al: Allogeneic stem cell transplantation for acute myeloid leukemia in first complete remission: systematic review and meta-analysis of prospective clinical trials. *JAMA* 301:2349, 2009
- NATIONAL COMPREHENSIVE CANCER NETWORK: Acute myeloid leukemia. Clinical Practice Guidelines in Oncology, Version 1. 2006. URL: [http://www.nccn.org/professionals/physician\\_gls/PDF/aml.pdf](http://www.nccn.org/professionals/physician_gls/PDF/aml.pdf)
- SANZ MA et al: Tricks of the trade for the appropriate management of newly diagnosed acute promyelocytic leukemia. *Blood* 105:3019, 2005
- SHIPLEY JL, BUTERA JN: Acute myelogenous leukemia. *Exp Haematol* 37:649, 2009
- TALLMAN MS et al: Drug therapy for acute myeloid leukemia. *Blood* 106:1154, 2005

### CML

- CORTES J, KANTARJIAN H: New targeted approaches in chronic myeloid leukemia. *J Clin Oncol* 23:6316, 2005
- HUGHES TP et al: Monitoring CML patients responding to treatment with tyrosine kinase inhibitors. Review and recommendations for 'harmonizing' current methodology for detecting *BCR-ABL* transcripts and kinase domain mutations and for expressing results. *Blood* 108:28, 2006
- JABBOUR E et al: Treatment selection after imatinib resistance in chronic myeloid leukemia. *Target Oncol* 4:3, 2009
- NATIONAL COMPREHENSIVE CANCER NETWORK: Chronic myelogenous leukemia. Clinical Practice Guidelines in Oncology, Version 1. 2007. URL: [http://www.nccn.org/professionals/physician\\_gls/PDF/cml.pdf](http://www.nccn.org/professionals/physician_gls/PDF/cml.pdf)
- PAVLOVSKY C et al: First-line therapy for chronic myeloid leukemia: Past, present and future. *Am J Hematol* 84:287, 2009



## CHAPTER 15

# MALIGNANCIES OF LYMPHOID CELLS

Dan L. Longo

■ Biology of Lymphoid Malignancies: Concepts of the WHO Classification of Lymphoid Malignancies . . . . .	182	Precursor Cell B Cell Neoplasms . . . . .	191
■ General Aspects of Lymphoid Malignancies . . . . .	184	Mature (Peripheral) B Cell Neoplasms . . . . .	192
Etiology and Epidemiology . . . . .	184	Precursor Cell T Cell Malignancies . . . . .	199
Immunology . . . . .	186	Mature (Peripheral) T Cell Disorders . . . . .	200
■ Clinical Features, Treatment, and Prognosis of Specific Lymphoid Malignancies . . . . .	191	Hodgkin's Disease . . . . .	202
		■ Lymphoma-Like Disorders . . . . .	204
		■ Further Readings . . . . .	204

Malignancies of lymphoid cells range from the most indolent to the most aggressive human malignancies. These cancers arise from cells of the immune system at different stages of differentiation, resulting in a wide range of morphologic, immunologic, and clinical findings. Insights on the normal immune system have allowed a better understanding of these sometimes confusing disorders.

Some malignancies of lymphoid cells almost always present as leukemia (i.e., primary involvement of bone marrow and blood), whereas others almost always present as lymphomas (i.e., solid tumors of the immune system). However, other malignancies of lymphoid cells can present as either leukemia or lymphoma. In addition, the clinical pattern can change over the course of the illness. This change is more often seen in a patient who seems to have a lymphoma and then develops the manifestations of leukemia over the course of the illness.

### BIOLOGY OF LYMPHOID MALIGNANCIES: CONCEPTS OF THE WHO CLASSIFICATION OF LYMPHOID MALIGNANCIES

The classification of lymphoid cancers evolved steadily throughout the twentieth century. The distinction between leukemia and lymphoma was made early, and separate classification systems were developed for each. Leukemias were first divided into acute and chronic

subtypes based on average survival. Chronic leukemias were easily subdivided into those of lymphoid or myeloid origin based on morphologic characteristics. However, a spectrum of diseases that were formerly all called *chronic lymphoid leukemia* has become apparent (Table 15-1). The acute leukemias were usually malignancies of blast cells with few identifying characteristics. When cytochemical stains became available, it was possible to divide these objectively into myeloid malignancies and acute leukemias of lymphoid cells. Acute leukemias of lymphoid cells have been subdivided based on morphologic characteristics by the French-American-British (FAB) group (Table 15-2). Using this system, lymphoid malignancies of small uniform blasts (e.g., typical childhood acute lymphoblastic leukemia) were called L1, lymphoid malignancies with larger and more variable size

**TABLE 15-1**

#### LYMPHOID DISORDERS THAT CAN PRESENT AS “CHRONIC LEUKEMIA” AND BE CONFUSED WITH TYPICAL B CELL CHRONIC LYMPHOID LEUKEMIA

Follicular lymphoma	Polymorphocytic leukemia (B cell or T cell)
Splenic marginal zone lymphoma	Lymphoplasmacytic lymphoma
Nodal marginal zone lymphoma	Sézary syndrome
Mantle cell lymphoma	Smoldering adult T cell leukemia/lymphoma
Hairy cell leukemia	

TABLE 15-2

## CLASSIFICATION OF ACUTE LYMPHOID LEUKEMIA (ALL)

IMMUNOLOGIC SUBTYPE	% OF CASES	FAB SUBTYPE	CYTOGENETIC ABNORMALITIES
Pre-B ALL	75	L1, L2	t(9;22), t(4;11), t(1;19)
T cell ALL	20	L1, L2	14q11 or 7q34
B cell ALL	5	L3	t(8;14), t(8;22), t(2;8)

**Note:** FAB, French-American-British classification.

cells were called L2, and lymphoid malignancies of uniform cells with basophilic and sometimes vacuolated cytoplasm were called L3 (e.g., typical Burkitt's lymphoma cells). Acute leukemias of lymphoid cells have also been subdivided based on immunologic (i.e., T cell vs B cell) and cytogenetic abnormalities (Table 15-2). Major cytogenetic subgroups include the t(9;22) (e.g., Philadelphia chromosome-positive acute lymphoblastic leukemia) and the t(8;14) found in the L3 or Burkitt's leukemia.

Non-Hodgkin's lymphomas were separated from Hodgkin's disease by recognition of the Sternberg-Reed cells early in the twentieth century. The histologic classification for non-Hodgkin's lymphomas has been

one of the most contentious issues in oncology. Imperfect morphologic systems were supplanted by imperfect immunologic systems, and poor reproducibility of diagnosis has hampered progress. In 1999, the World Health Organization (WHO) classification of lymphoid malignancies was devised through a process of consensus development among international leaders in hematopathology and clinical oncology. The WHO classification takes into account morphologic, clinical, immunologic, and genetic information and attempts to divide non-Hodgkin's lymphomas and other lymphoid malignancies into clinical/pathologic entities that have clinical and therapeutic relevance. This system is presented in Table 15-3.

TABLE 15-3

## WHO CLASSIFICATION OF LYMPHOID MALIGNANCIES

B CELL	T CELL	HODGKIN'S DISEASE
Precursor B cell neoplasm <b>Precursor B lymphoblastic leukemia/lymphoma (precursor B cell acute lymphoblastic leukemia)</b>	Precursor T cell neoplasm <b>Precursor T lymphoblastic lymphoma/leukemia (precursor T cell acute lymphoblastic leukemia)</b>	Nodular lymphocyte-predominant Hodgkin's disease
Mature (peripheral) B cell neoplasms <b>B cell chronic lymphocytic leukemia/small lymphocytic lymphoma</b> B cell prolymphocytic leukemia	Mature (peripheral) T cell neoplasms T cell prolymphocytic leukemia	Classical Hodgkin's disease Nodular sclerosis Hodgkin's disease
Lymphoplasmacytic lymphoma	T cell granular lymphocytic leukemia	Lymphocyte-rich classic Hodgkin's disease
Splenic marginal zone B cell lymphoma (± villous lymphocytes) Hairy cell leukemia <b>Plasma cell myeloma/plasmacytoma</b> <b>Extranodal marginal zone B cell lymphoma of MALT type</b> <b>Mantle cell lymphoma</b>	Aggressive NK cell leukemia	Mixed-cellularity Hodgkin's disease
<b>Follicular lymphoma</b> Nodal marginal zone B cell lymphoma (± monocytoid B cells) <b>Diffuse large B cell lymphoma</b> <b>Burkitt's lymphoma/Burkitt cell leukemia</b>	Adult T cell lymphoma/leukemia (HTLV-I+) Extranodal NK/T cell lymphoma, nasal type Enteropathy-type T cell lymphoma Hepatosplenic γδ T cell lymphoma	Lymphocyte-depletion Hodgkin's disease
	Subcutaneous panniculitis-like T cell lymphoma <b>Mycosis fungoides/Sézary syndrome</b> Anaplastic large cell lymphoma, primary cutaneous type <b>Peripheral T cell lymphoma, not otherwise specified (NOS)</b> <b>Angioimmunoblastic T cell lymphoma</b> <b>Anaplastic large cell lymphoma, primary systemic type</b>	

**Note:** HTLV, human T cell lymphotropic virus; MALT, mucosa-associated lymphoid tissue; NK, natural killer; WHO, World Health Organization. Malignancies in bold occur in at least 1% of patients.

**Source:** Adapted from Harris et al.



This system is clinically relevant and has a higher degree of diagnostic accuracy than those used previously. The possibilities for subdividing lymphoid malignancies are extensive. However, Table 15-3 presents in bold those malignancies that occur in at least 1% of patients. Specific lymphoma subtypes are dealt with in more detail later.

## GENERAL ASPECTS OF LYMPHOID MALIGNANCIES

### ETIOLOGY AND EPIDEMIOLOGY

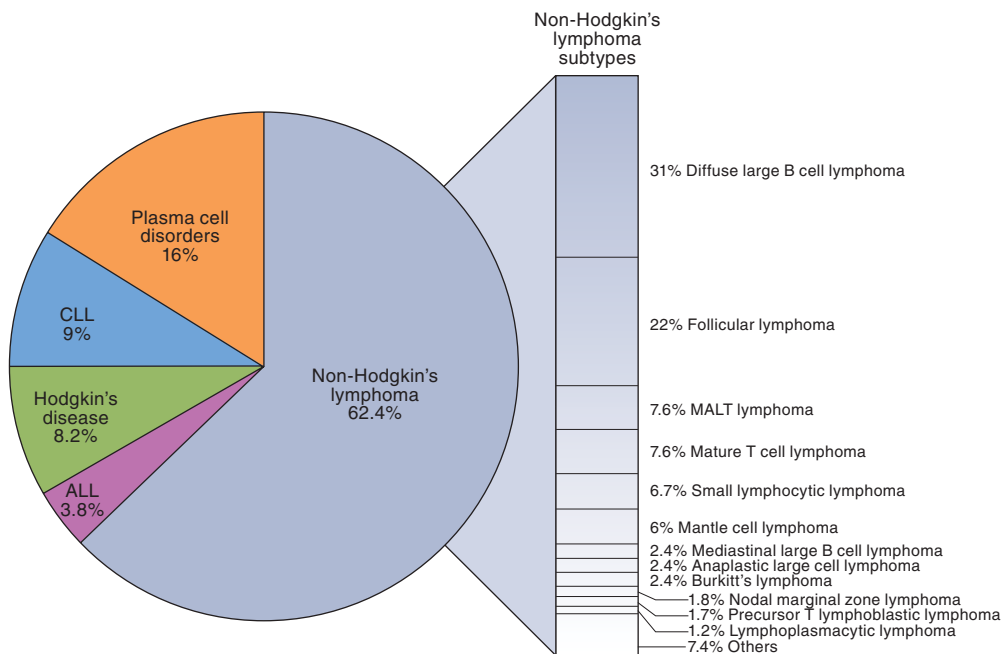
The relative frequency of the various lymphoid malignancies is shown in **Fig. 15-1**. Chronic lymphoid leukemia (CLL) is the most prevalent form of leukemia in Western countries. It occurs most frequently in older adults and is exceedingly rare in children. In 2007, 15,340 new cases were diagnosed in the United States, but because of the prolonged survival associated with this disorder, the total prevalence is many times higher. CLL is more common in men than in women and more common in whites than in blacks. This is an uncommon malignancy in Asia. The etiologic factors for typical CLL are unknown.

In contrast to CLL, acute lymphoid leukemias (ALLs) are predominantly cancers of children and young adults. The L3 or Burkitt's leukemia occurring in children in developing countries seems to be associated with infection by the Epstein-Barr virus (EBV) in infancy. However, the explanation for the etiology of more common subtypes of ALL is much less certain. Childhood ALL

occurs more often in higher socioeconomic subgroups. Children with trisomy 21 (Down's syndrome) have an increased risk for childhood acute lymphoblastic leukemia as well as acute myeloid leukemia. Exposure to high-energy radiation in early childhood increases the risk of developing T cell acute lymphoblastic leukemia.

The etiology of ALL in adults is also uncertain. ALL is unusual in middle-aged adults but increases in incidence in the elderly. However, acute myeloid leukemia is still much more common in older patients. Environmental exposures including certain industrial exposures, exposure to agricultural chemicals, and smoking might increase the risk of developing ALL as an adult. ALL was diagnosed in 5200 persons and AML in 13,410 persons in the United States in 2007.

The preponderance of evidence suggests that Hodgkin's disease is of B cell origin. The incidence of Hodgkin's disease appears fairly stable, with 8190 new cases diagnosed in 2007 in the United States. Hodgkin's disease is more common in whites than in blacks and more common in males than in females. A bimodal distribution of age at diagnosis has been observed, with one peak incidence occurring in patients in their twenties and the other in those in their eighties. Some of the late-age peak may be attributed to confusion among entities with similar appearance such as anaplastic large cell lymphoma and T cell-rich B cell lymphoma. Patients in the younger age groups diagnosed in the United States largely have the nodular sclerosing subtype of Hodgkin's disease. Elderly patients, patients infected with HIV, and patients in developing countries more commonly have mixed-cellularity



**FIGURE 15-1**  
Relative frequency of lymphoid malignancies.

Hodgkin's disease or lymphocyte-depleted Hodgkin's disease. Infection by HIV is a risk factor for developing Hodgkin's disease. In addition, an association between infection by EBV and Hodgkin's disease has been suggested. A monoclonal or oligoclonal proliferation of EBV-infected cells in 20–40% of the patients with Hodgkin's disease has led to proposals for this virus having an etiologic role in Hodgkin's disease. However, the matter is not settled definitively.

For unknown reasons, non-Hodgkin's lymphomas increased in frequency in the United States at the rate of 4% per year between 1950 and the late 1990s. The rate of increase in the past few years seems to be decreasing. About 63,190 new cases of non-Hodgkin's lymphoma were diagnosed in the United States in 2007. Non-Hodgkin's lymphomas are more frequent in the elderly and more frequent in men. Patients with both primary and secondary immunodeficiency states are predisposed to developing non-Hodgkin's lymphomas. These include patients with HIV infection; patients who have undergone organ transplantation; and patients with inherited immune deficiencies, the sicca syndrome, and rheumatoid arthritis.

The incidence of non-Hodgkin's lymphomas and the patterns of expression of the various subtypes differ geographically. T cell lymphomas are more common in Asia than in Western countries; certain subtypes of B cell lymphomas such as follicular lymphoma are more common in Western countries. A specific subtype of non-Hodgkin's lymphoma known as the angiocentric nasal T/natural killer (NK) cell lymphoma has a striking geographic occurrence, being most frequent in South Asia and parts of Latin America. Another subtype of non-Hodgkin's lymphoma associated with infection by human T cell lymphotropic virus (HTLV) I is seen particularly in southern Japan and the Caribbean.

A number of environmental factors have been implicated in the occurrence of non-Hodgkin's lymphoma, including infectious agents, chemical exposures, and medical treatments. Several studies have demonstrated an association between exposure to agricultural chemicals and an increased incidence in non-Hodgkin's lymphoma. Patients treated for Hodgkin's disease can develop non-Hodgkin's lymphoma; it is unclear whether this is a consequence of the Hodgkin's disease or its treatment. However, a number of non-Hodgkin's lymphomas are associated with infectious agents (Table 15-4). HTLV-I infects T cells and leads directly to the development of adult T cell lymphoma (ATL) in a small percentage of infected patients. The cumulative lifetime risk of developing lymphoma in an infected patient is 2.5%. The virus is transmitted by infected lymphocytes ingested by nursing babies of infected mothers, blood-borne transmission, or sexually. The median age of patients with ATL is ~56 years, emphasizing the long latency. HTLV-I is also the cause of tropical spastic paraparesis—a neurologic disorder that

TABLE 15-4

## INFECTIOUS AGENTS ASSOCIATED WITH THE DEVELOPMENT OF LYMPHOID MALIGNANCIES

INFECTIOUS AGENT	LYMPHOID MALIGNANCY
Epstein-Barr virus	Burkitt's lymphoma Post-organ transplant lymphoma Primary CNS diffuse large B cell lymphoma Hodgkin's disease Extranodal NK/T cell lymphoma, nasal type
HTLV-I	Adult T cell leukemia/lymphoma
HIV	Diffuse large B cell lymphoma Burkitt's lymphoma
Hepatitis C virus	Lymphoplasmacytic lymphoma
<i>Helicobacter pylori</i>	Gastric MALT lymphoma
Human herpesvirus 8	Primary effusion lymphoma Multicentric Castleman's disease

**Note:** CNS, central nervous system; HTLV, human T cell lymphotropic virus; MALT, mucosa-associated lymphoid tissue; NK, natural killer.

occurs somewhat more frequently than lymphoma and with shorter latency and usually from transfusion-transmitted virus.

EBV is associated with the development of Burkitt's lymphoma in Central Africa and the occurrence of aggressive non-Hodgkin's lymphomas in immunosuppressed patients in Western countries. Most primary central nervous system (CNS) lymphomas are associated with EBV. EBV infection is strongly associated with the occurrence of extranodal nasal T/NK cell lymphomas in Asia and South America. Infection with HIV predisposes to the development of aggressive, B cell non-Hodgkin's lymphoma. This may be through overexpression of interleukin 6 by infected macrophages. Infection of the stomach by the bacterium *Helicobacter pylori* induces the development of gastric MALT (mucosa-associated lymphoid tissue) lymphomas. This association is supported by evidence that patients treated with antibiotics to eradicate *H. pylori* have regression of their MALT lymphoma. The bacterium does not transform lymphocytes to produce the lymphoma; instead, a vigorous immune response is made to the bacterium, and the chronic antigenic stimulation leads to the neoplasia. MALT lymphomas of the skin may be related to *Borrelia* sp. infections, those of the eyes to *Chlamydomphila psittaci*, and those of the small intestine to *Campylobacter jejuni*.

Chronic hepatitis C virus infection has been associated with the development of lymphoplasmacytic lymphoma. Human herpesvirus 8 is associated with primary effusion lymphoma in HIV-infected persons and multicentric Castleman's disease, a diffuse lymphadenopathy associated with systemic symptoms of fever, malaise, and weight loss.

TABLE 15-5

## DISEASES OR EXPOSURES ASSOCIATED WITH INCREASED RISK OF DEVELOPMENT OF MALIGNANT LYMPHOMA

Inherited immunodeficiency disease	Autoimmune disease
Klinefelter's syndrome	Sjögren's syndrome
Chédiak-Higashi syndrome	Celiac sprue
Ataxia telangiectasia syndrome	Rheumatoid arthritis and systemic lupus erythematosus
Wiskott-Aldrich syndrome	Chemical or drug exposures
Common variable immunodeficiency disease	Phenytoin
Acquired immunodeficiency diseases	Dioxin, phenoxyherbicides
Iatrogenic immunosuppression	Radiation
HIV-1 infection	Prior chemotherapy and radiation therapy
Acquired hypogammaglobulinemia	

In addition to infectious agents, a number of other diseases or exposures may predispose to developing lymphoma (Table 15-5).

## IMMUNOLOGY

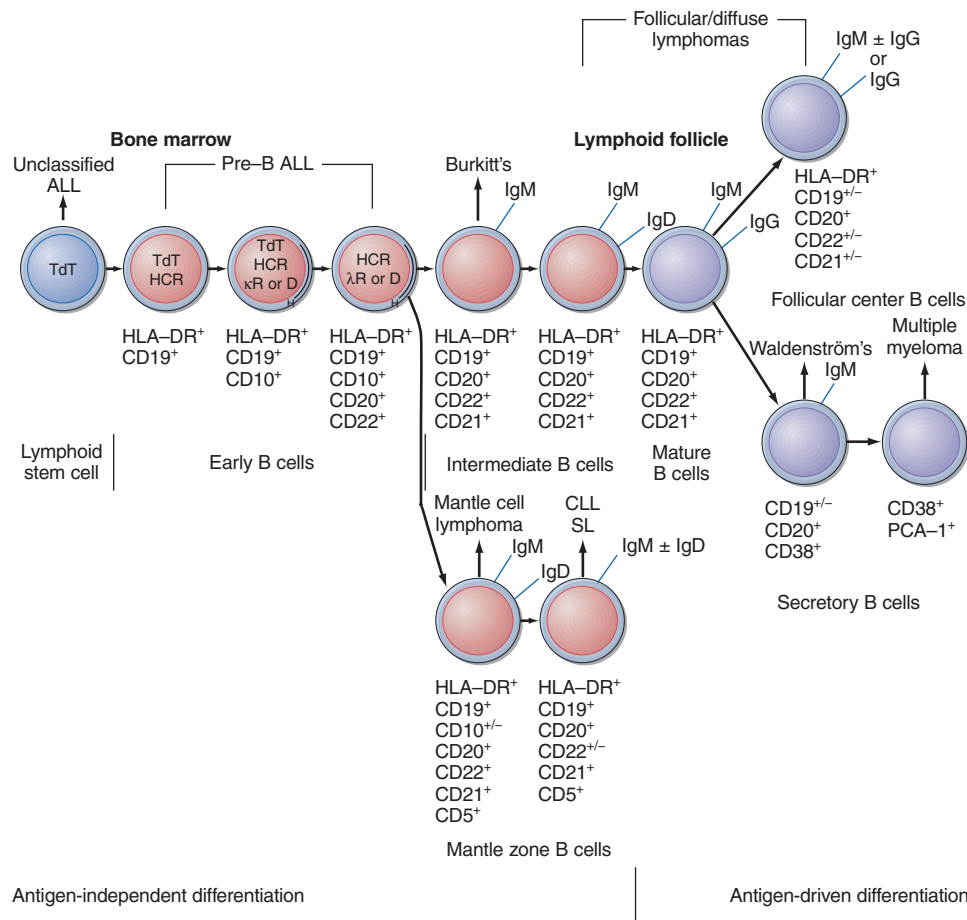
All lymphoid cells are derived from a common hematopoietic progenitor that gives rise to lymphoid, myeloid, erythroid, monocyte, and megakaryocyte lineages. Through the ordered and sequential activation of a series of transcription factors, the cell first becomes committed to the lymphoid lineage and then gives rise to B and T cells. About 75% of all lymphoid leukemias and 90% of all lymphomas are of B cell origin. A cell becomes committed to B cell development when it begins to rearrange its immunoglobulin genes. The sequence of cellular changes, including changes in cell-surface phenotype, that characterizes normal B cell development is shown in Fig. 15-2. A cell becomes committed to T cell differentiation upon migration to the thymus and rearrangement of T cell antigen receptor genes. The sequence of the events that characterize T cell development is depicted in Fig. 15-3.

Although lymphoid malignancies often retain the cell-surface phenotype of lymphoid cells at particular stages of differentiation, this information is of little consequence. The so-called stage of differentiation of a malignant lymphoma does not predict its natural history. For example, the clinically most aggressive lymphoid leukemia is Burkitt's leukemia, which has the phenotype of a mature follicle center IgM-bearing B cell. Leukemias bearing the immunologic cell-surface phenotype of more primitive cells (e.g., pre-B ALL, CD10+) are less aggressive and more amenable to curative therapy than the "more mature" appearing Burkitt's leukemia cells. Furthermore, the apparent stage of differentiation of the malignant cell does not reflect the stage at which the genetic lesions that gave rise to the malignancy developed. For example,

follicular lymphoma has the cell-surface phenotype of a follicle center cell, but its characteristic chromosomal translocation, the t(14;18), which involves juxtaposition of the antiapoptotic *bcl-2* gene next to the immunoglobulin heavy chain gene (see later), had to develop early in ontogeny as an error in the process of immunoglobulin gene rearrangement. Why the subsequent steps that led to transformation became manifest in a cell of follicle center differentiation is not clear.

The major value of cell-surface phenotyping is to aid in the differential diagnosis of lymphoid tumors that appear similar by light microscopy. For example, benign follicular hyperplasia may resemble follicular lymphoma; however, the demonstration that all the cells bear the same immunoglobulin light chain isotype strongly suggests the mass is a clonal proliferation rather than a polyclonal response to an exogenous stimulus.

Malignancies of lymphoid cells are associated with recurring genetic abnormalities. Although specific genetic abnormalities have not been identified for all subtypes of lymphoid malignancies, it is presumed that they exist. Genetic abnormalities can be identified at a variety of levels including gross chromosomal changes (i.e., translocations, additions, or deletions); rearrangement of specific genes that may or may not be apparent from cytogenetic studies; and overexpression, underexpression, or mutation of specific oncogenes. Altered expression or mutation of specific proteins is particularly important. Many lymphomas contain balanced chromosomal translocations involving the antigen receptor genes; immunoglobulin genes on chromosomes 2, 14, and 22 in B cells; and T cell antigen receptor genes on chromosomes 7 and 14 in T cells. The rearrangement of chromosome segments to generate mature antigen receptors must create a site of vulnerability to aberrant recombination. B cells are even more susceptible to acquiring mutations during their maturation in germinal centers; the generation of antibody of higher affinity requires the introduction of mutations into the variable region genes in the germinal centers.

**FIGURE 15-2**

**Pathway of normal B cell differentiation and relationship to B cell lymphomas.** HLA-DR, CD10, CD19, CD20, CD21, CD22, CD5, and CD38 are cell markers used to distinguish stages of development. Terminal transferase (TdT) is a cellular enzyme. Immunoglobulin heavy chain gene rearrangement

(HCR) and light chain gene rearrangement or deletion (κR or D, λR or D) occur early in B cell development. The approximate normal stage of differentiation associated with particular lymphomas is shown. ALL, acute lymphoid leukemia; CLL, chronic lymphoid leukemia; SL, small lymphocytic lymphoma.

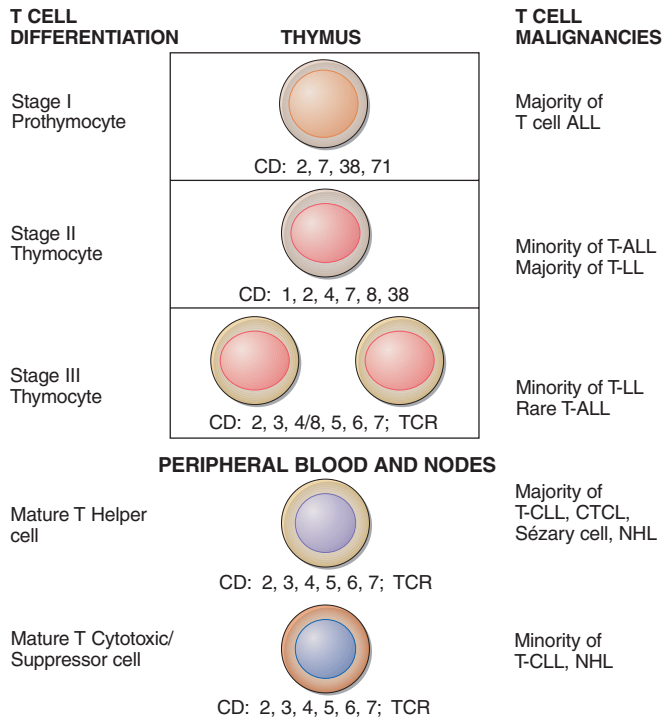
Other nonimmunoglobulin genes, e.g., *bcl-6*, may acquire mutations as well.

In the case of diffuse large B cell lymphoma, the translocation t(14;18) occurs in ~30% of patients and leads to overexpression of the *bcl-2* gene found on chromosome 18. Some other patients without the translocation also overexpress the BCL-2 protein. This protein is involved in suppressing apoptosis—i.e., the mechanism of cell death most often induced by cytotoxic chemotherapeutic agents. A higher relapse rate has been observed in patients whose tumors overexpress the BCL-2 protein, but not in those patients whose lymphoma cells show only the translocation. Thus particular genetic mechanisms have clinical ramifications.

**Table 15-6** presents the best documented translocations and associated oncogenes for various subtypes of lymphoid malignancies. In some cases, such as the association of the t(14;18) in follicular lymphoma, the t(2;5) in anaplastic large T/null cell lymphoma, the t(8;14) in Burkitt's lymphoma, and the t(11;14) in mantle cell

lymphoma, the great majority of tumors in patients with these diagnoses display these abnormalities. In other types of lymphoma where a minority of the patients have tumors expressing specific genetic abnormalities, the defects may have prognostic significance. No specific genetic abnormalities have been identified in Hodgkin's disease other than aneuploidy.

In typical B cell CLL, trisomy 12 conveys a poorer prognosis. In ALL in both adults and children, genetic abnormalities have important prognostic significance. Patients whose tumor cells display the t(9;22) have a much poorer outlook than patients who do not have this translocation. Other genetic abnormalities that occur frequently in adults with ALL include the t(4;11) and the t(8;14). The t(4;11) is associated with younger age, female predominance, high white cell counts, and L1 morphology. The t(8;14) is associated with older age, male predominance, frequent CNS involvement, and L3 morphology. Both are associated with a poor prognosis. In childhood ALL, hyperdiploidy has been shown to have a favorable prognosis.

**FIGURE 15-3**

**Pathway of normal T cell differentiation and relationship to T cell lymphomas.** CD1, CD2, CD3, CD4, CD5, CD6, CD7, CD8, CD38, and CD71 are cell markers used to distinguish stages of development. T cell antigen receptors (TCR) rearrange in the thymus, and mature T cells emigrate to nodes and peripheral blood. ALL, acute lymphoid leukemia; T-ALL, T cell ALL; T-LL, T cell lymphoblastic lymphoma; T-CLL, T cell chronic lymphoid leukemia; CTCL, cutaneous T cell lymphoma; NHL, non-Hodgkin's lymphoma.

Gene profiling using array technology allows the simultaneous assessment of the expression of thousands of genes. This technology provides the possibility to identify new genes with pathologic importance in lymphomas, the identification of patterns of gene expression with diagnostic and/or prognostic significance, and the identification of new therapeutic targets. Recognition of patterns of gene expression is complicated and requires sophisticated mathematical techniques. Early successes using this technology in lymphoma include the identification of previously unrecognized subtypes of diffuse large B cell lymphoma whose gene expression patterns resemble either those of follicular center B cells or activated peripheral blood B cells. Patients whose lymphomas have a germinal center B cell pattern of gene expression have a considerably better prognosis than those whose lymphomas have a pattern resembling activated peripheral blood B cells. This improved prognosis is independent of other known prognostic factors. Similar information is being generated in follicular lymphoma and mantle cell lymphoma. The challenge remains to provide information from such techniques in a clinically useful time frame.

#### Approach to the Patient: LYMPHOID CELL MALIGNANCIES

Regardless of the type of lymphoid malignancy, the initial evaluation of the patient should include performance of a careful history and physical examination. These will help confirm the diagnosis, identify those manifestations of the disease that might require prompt

**TABLE 15-6**

#### CYTOGENETIC TRANSLOCATION AND ASSOCIATED ONCOGENES OFTEN SEEN IN LYMPHOID MALIGNANCIES

DISEASE	CYTOGENETIC ABNORMALITY	ONCOGENE
CLL/small lymphocytic lymphoma	t(14;15)(q32;q13)	—
MALT lymphoma	t(11;18)(q21;q21)	API2/MALT, BCL-10
Precursor B cell acute lymphoid leukemia	t(9;22)(q34;q11) or variant	BCR/ABL
Precursor acute lymphoid leukemia	t(4;11)(q21;q23)	AF4, ALL1
	t(9;22)	BCR, ABL
	t(1;19)	E2A, PBX
	t(17;19)	HLF, E2A
	t(5;14)	HOX11L2, CTIP2
Mantle cell lymphoma	t(11;14)(q13;q32)	BCL-1, IgH
Follicular lymphoma	t(14;18)(q32;q21)	BCL-2, IgH
Diffuse large cell lymphoma	t(3;-(q27;-) <sup>a</sup>	BCL-6
	t(17;-(p13;-)	p53
Burkitt's lymphoma, Burkitt's leukemia	t(8;-(q24;-) <sup>a</sup>	C-MYC
CD30+ Anaplastic large cell lymphoma	t(2;5)(p23;q35)	ALK
Lymphoplasmacytoid lymphoma	t(9;14)(p13;q32)	PAX5, IgH

<sup>a</sup>Numerous sites of translocation may be involved with these genes.

**Note:** CLL, chronic lymphoid leukemia; MALT, mucosa-associated lymphoid tissue; IgH, immunoglobulin heavy chain.

attention, and aid in the selection of further studies to optimally characterize the patient's status and allow the best choice of therapy. It is difficult to overemphasize the importance of a carefully done history and physical examination. They might provide observations that lead to reconsidering the diagnosis, provide hints at etiology, clarify the stage, and allow the physician to establish rapport with the patient that will make it possible to develop and carry out a therapeutic plan.

For patients with ALL, evaluation is usually completed after a complete blood count, chemistry studies reflecting major organ function, a bone marrow biopsy with genetic and immunologic studies, and a lumbar puncture. The latter is necessary to rule out occult CNS involvement. At this point, most patients would be ready to begin therapy. In ALL, prognosis depends on the genetic characteristics of the tumor, the patient's age, the white cell count, and the patient's overall clinical status and major organ function.

In CLL, the patient evaluation should include a complete blood count, chemistry tests to measure major organ function, serum protein electrophoresis, and a bone marrow biopsy. However, some physicians believe that the diagnosis would not always require a bone marrow biopsy. Patients often have imaging studies of the chest and abdomen looking for pathologic lymphadenopathy. Patients with typical B cell CLL can be subdivided into three major prognostic groups. Those patients with only blood and bone marrow involvement by leukemia but no lymphadenopathy, organomegaly, or signs of bone marrow failure have the best prognosis. Those with lymphadenopathy and organomegaly have an intermediate prognosis,

and patients with bone marrow failure, defined as hemoglobin  $<100$  g/L (10 g/dL) or platelet count  $<100,000/\mu\text{L}$ , have the worst prognosis. The pathogenesis of the anemia or thrombocytopenia is important to discern. The prognosis is adversely affected when either or both of these abnormalities are due to progressive marrow infiltration and loss of productive marrow. However, either or both may be due to autoimmune phenomena or to hypersplenism that can develop during the course of the disease. These destructive mechanisms are usually completely reversible (glucocorticoids for autoimmune disease; splenectomy for hypersplenism) and do not influence disease prognosis.

Two popular staging systems have been developed to reflect these prognostic groupings (Table 15-7). Patients with typical B cell CLL can have their course complicated by immunologic abnormalities including autoimmune hemolytic anemia, autoimmune thrombocytopenia, and hypogammaglobulinemia. Patients with hypogammaglobulinemia benefit from regular (monthly  $\gamma$  globulin administration. Because of expense  $\gamma$  globulin is often withheld until the patient experiences a significant infection. These abnormalities do not have a clear prognostic significance and should not be used to assign a higher stage.

Two other features may be used to assess prognosis in B cell CLL, but neither has yet been incorporated into a staging classification. At least two subsets of CLL have been identified based on the cytoplasmic expression of ZAP-70; expression of this protein, which is usually expressed in T cells, identifies a subgroup with poorer prognosis. A less powerful subsetting tool is CD38 expression. CD38+ tumors tend to have a poorer prognosis than CD38- tumors.

TABLE 15-7

## STAGING OF TYPICAL B CELL LYMPHOID LEUKEMIA

STAGE	CLINICAL FEATURES	MEDIAN SURVIVAL, YEARS
<b>RAI System</b>		
0: Low risk	Lymphocytosis only in blood and marrow	$>10$
I: Intermediate risk	Lymphocytosis + lymphadenopathy + splenomegaly $\pm$ hepatomegaly	7
II		
III: High risk	Lymphocytosis + anemia	1.5
IV	Lymphocytosis + thrombocytopenia	
<b>Binet System</b>		
A	Fewer than three areas of clinical lymphadenopathy; no anemia or thrombocytopenia	$>10$
B	Three or more involved node areas; no anemia or thrombocytopenia	7
C	Hemoglobin $\leq 10$ g/dL and/or platelets $<100,000/\mu\text{L}$	2

**TABLE 15-8****THE ANN ARBOR STAGING SYSTEM FOR HODGKIN'S DISEASE**

STAGE	DEFINITION
I	Involvement of a single lymph node region or lymphoid structure (e.g., spleen, thymus, Waldeyer's ring)
II	Involvement of two or more lymph node regions on the same side of the diaphragm (the mediastinum is a single site; hilar lymph nodes should be considered "lateralized" and, when involved on both sides, constitute stage II disease)
III	Involvement of lymph node regions or lymphoid structures on both sides of the diaphragm
III <sub>1</sub>	Subdiaphragmatic involvement limited to spleen, splenic hilar nodes, celiac nodes, or portal nodes
III <sub>2</sub>	Subdiaphragmatic involvement includes paraaortic, iliac, or mesenteric nodes plus structures in III <sub>1</sub>
IV	Involvement of extranodal site(s) beyond that designated as "E" More than one extranodal deposit at any location Any involvement of liver or bone marrow
A	No symptoms
B	Unexplained weight loss of >10% of the body weight during the 6 months before staging investigation Unexplained, persistent, or recurrent fever with temperatures >38°C during the previous month Recurrent drenching night sweats during the previous month
E	Localized, solitary involvement of extralymphatic tissue, excluding liver and bone marrow

The initial evaluation of a patient with Hodgkin's disease or non-Hodgkin's lymphoma is similar. In both situations, the determination of an accurate anatomic stage is an important part of the evaluation. The staging system is the Ann Arbor staging system originally developed for Hodgkin's disease (**Table 15-8**).

Evaluation of patients with Hodgkin's disease typically includes a complete blood count; erythrocyte sedimentation rate; chemistry studies reflecting major organ function; CT scans of the chest, abdomen, and pelvis; and a bone marrow biopsy. Neither a positron emission tomography (PET) scan nor a gallium scan is absolutely necessary for primary staging, but one performed at the completion of therapy allows evaluation of persisting radiographic abnormalities, particularly the mediastinum. Knowing that the PET scan or gallium scan is abnormal before treatment can help in this assessment. In most cases, these studies allow assignment of anatomic stage and the development of a therapeutic plan.

In patients with non-Hodgkin's lymphoma, the same evaluation described for patients with Hodgkin's disease is usually carried out. In addition, serum levels of lactate dehydrogenase (LDH) and  $\beta_2$ -microglobulin and serum protein electrophoresis are often included in the evaluation. Anatomic stage is assigned in the same manner as used for Hodgkin's disease. However, the prognosis of patients with non-Hodgkin's lymphoma is best assigned using the International Prognostic Index (IPI) (**Table 15-9**). This is a powerful predictor of outcome in all subtypes of non-Hodgkin's lymphoma. Patients are assigned an IPI score based on the presence or absence of five adverse prognostic factors and may have none or all five of these adverse prognostic factors. **Figure 15-4** shows the prognostic significance of

**TABLE 15-9****INTERNATIONAL PROGNOSTIC INDEX FOR NHL**

Five clinical risk factors:

- Age  $\geq 60$  years
- Serum lactate dehydrogenase levels elevated
- Performance status  $\geq 2$  (ECOG) or  $\leq 70$  (Karnofsky)
- Ann Arbor stage III or IV
- >1 site of extranodal involvement

Patients are assigned a number for each risk factor they have

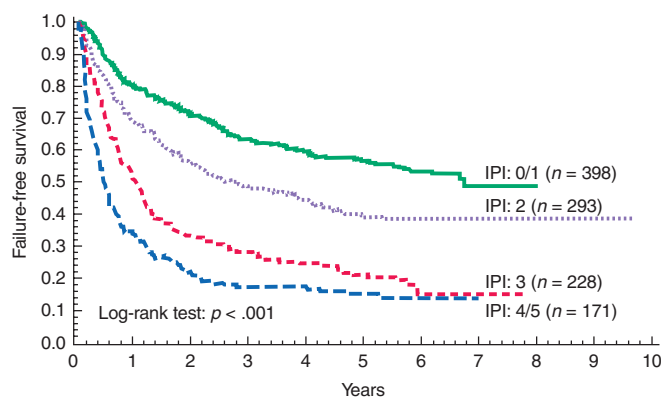
Patients are grouped differently based on the type of lymphoma

For diffuse large B cell lymphoma:

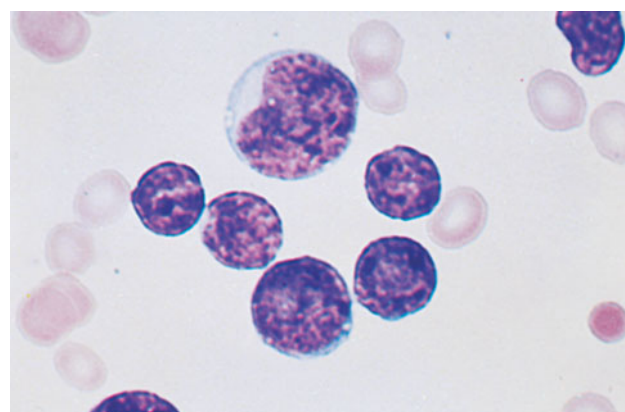
- |                                     |                                    |
|-------------------------------------|------------------------------------|
| 0, 1 factor = low risk:             | 35% of cases; 5-year survival, 73% |
| 2 factors = low-intermediate risk:  | 27% of cases; 5-year survival, 51% |
| 3 factors = high-intermediate risk: | 22% of cases; 5-year survival, 43% |
| 4, 5 factors = high risk:           | 16% of cases; 5-year survival, 26% |

For diffuse large B cell lymphoma treated with R-CHOP:

- |                         |                                    |
|-------------------------|------------------------------------|
| 0 factor = very good:   | 10% of cases; 5-year survival, 94% |
| 1, 2 factors = good:    | 45% of cases; 5-year survival, 79% |
| 3, 4, 5 factors = poor: | 45% of cases; 5-year survival, 55% |



**FIGURE 15-4**  
**Relationship of International Prognostic Index (IPI) to survival.** Kaplan-Meier survival curves for 1300 patients with various kinds of lymphoma stratified according to the IPI.



**FIGURE 15-5**  
**Acute lymphoblastic leukemia.** The cells are heterogeneous in size, have round or convoluted nuclei, high nuclear/cytoplasmic ratio, and absence of cytoplasmic granules.

this score in 1300 patients with all types of non-Hodgkin's lymphoma. With the addition of rituximab to CHOP (cyclophosphamide, doxorubicin, vincristine, and prednisone), treatment outcomes have improved and the original IPI has lost some of its discrimination power. A revised IPI has been proposed that better predicts outcome of rituximab plus chemotherapy-based programs (Table 15-9). CT scans are routinely used in the evaluation of patients with all subtypes of non-Hodgkin's lymphoma, but PET and gallium scans are much more useful in aggressive subtypes such as diffuse large B cell lymphoma than in more indolent subtypes such as follicular lymphoma or small lymphocytic lymphoma. Although the IPI does divide patients with follicular lymphoma into subsets with distinct prognoses, the distribution of such patients is skewed toward lower-risk categories. A follicular lymphoma-specific IPI (FLIPI) has been proposed that replaces performance status with hemoglobin level [ $<120$  g/L ( $<12$  g/dL)] and number of extranodal sites with number of nodal sites (more than four). Low risk (zero or one factor) was assigned to 36% of patients, intermediate risk (two factors) to 37%, and poor risk (more than two factors) to 27% of patients.

## CLINICAL FEATURES, TREATMENT, AND PROGNOSIS OF SPECIFIC LYMPHOID MALIGNANCIES

### PRECURSOR CELL B CELL NEOPLASMS

#### *Precursor B Cell Lymphoblastic Leukemia/Lymphoma*

The most common cancer in childhood is B cell ALL. Although this disorder can also present as a lymphoma in either adults or children, presentation as lymphoma is rare.

The malignant cells in patients with precursor B cell lymphoblastic leukemia are most commonly of pre-B cell origin. Patients typically present with signs of bone marrow failure such as pallor, fatigue, bleeding, fever, and infection related to peripheral blood cytopenias. Peripheral blood counts regularly show anemia and thrombocytopenia but might show leukopenia, a normal leukocyte count, or leukocytosis based largely on the number of circulating malignant cells (Fig. 15-5). Extranodal sites of disease are frequently involved in patients who present with leukemia, including lymphadenopathy, hepato- or splenomegaly, CNS disease, testicular enlargement, and/or cutaneous infiltration.

The diagnosis is usually made by bone marrow biopsy, which shows infiltration by malignant lymphoblasts. Demonstration of a pre-B cell immunophenotype (Fig. 15-2) and, often, characteristic cytogenetic abnormalities (Table 15-6) confirm the diagnosis. An adverse prognosis in patients with precursor B cell ALL is predicted by a very high white cell count, the presence of symptomatic CNS disease, and unfavorable cytogenetic abnormalities. For example,  $t(9;22)$ , frequently found in adults with B cell ALL, has been associated with a very poor outlook. The bcr/abl kinase inhibitors have improved the prognosis.

#### **Treatment:** **Rx PRECURSOR B CELL LYMPHOBLASTIC LEUKEMIA**

The treatment of patients with precursor B cell ALL involves remission induction with combination chemotherapy, a consolidation phase that includes administration of high-dose systemic therapy and treatment to eliminate disease in the CNS, and a period of continuing therapy to prevent relapse and effect cure. The overall cure rate in children is



90%; ~50% of adults are long-term disease-free survivors. This reflects the high proportion of adverse cytogenetic abnormalities seen in adults with precursor B cell ALL.

Precursor B cell lymphoblastic lymphoma is a rare presentation of precursor B cell lymphoblastic malignancy. These patients often have a rapid transformation to leukemia and should be treated as though they had presented with leukemia. The few patients who present with the disease confined to lymph nodes have a high cure rate.

## MATURE (PERIPHERAL) B CELL NEOPLASMS

### *B Cell Chronic Lymphoid Leukemia/Small Lymphocytic Lymphoma*

B cell CLL/small lymphocytic lymphoma represents the most common lymphoid leukemia, and when presenting as a lymphoma, it accounts for ~7% of non-Hodgkin's lymphomas. Presentation can be as either leukemia or lymphoma. The major clinical characteristics of B cell CLL/small lymphocytic lymphoma are presented in [Table 15-10](#).

The diagnosis of typical B cell CLL is made when an increased number of circulating lymphocytes (i.e.,  $>4 \times 10^9/L$  and usually  $>10 \times 10^9/L$ ) is found ([Fig. 15-6](#)) that are monoclonal B cells expressing the CD5 antigen. Finding bone marrow infiltration by the same cells confirms the diagnosis. The peripheral blood smear in such patients typically shows many “smudge” or “basket” cells, nuclear remnants of cells damaged by the physical shear stress of making the blood smear. If cytogenetic studies are performed, trisomy 12 is found in 25–30% of patients. Abnormalities in chromosome 13 are also seen.

If the primary presentation is lymphadenopathy and a lymph node biopsy is performed, pathologists usually have little difficulty in making the diagnosis of small lymphocytic lymphoma based on morphologic findings and immunophenotype. However, even in these patients, 70–75% are found to have bone marrow involvement, and circulating monoclonal B lymphocytes are often present.

The differential diagnosis of typical B cell CLL is extensive ([Table 15-1](#)). Immunophenotyping will eliminate the T cell disorders and can often help sort out other B cell malignancies. For example, only mantle cell lymphoma and typical B cell CLL are usually CD5 positive. Typical B cell small lymphocytic lymphoma can be confused with other B cell disorders including lymphoplasmacytic lymphoma (i.e., the tissue manifestation of Waldenström's macroglobulinemia), nodal marginal zone B cell lymphoma, and mantle cell lymphoma. In addition, some small lymphocytic lymphomas have areas of large cells that can lead to confusion with diffuse large B cell lymphoma. An expert hematopathologist is vital for making this distinction.

Typical B cell CLL is often found incidentally when a complete blood count is done for another reason. However, complaints that might lead to the diagnosis include fatigue, frequent infections, and new lymphadenopathy. The diagnosis of typical B cell CLL should be considered in a patient presenting with an autoimmune hemolytic anemia or autoimmune thrombocytopenia. B cell CLL has also been associated with red cell aplasia. When this disorder presents as lymphoma, the most common abnormality is asymptomatic lymphadenopathy, with or without splenomegaly. The staging systems predict prognosis in patients with typical B cell CLL ([Table 15-7](#)). The evaluation of a new patient with typical B cell CLL/small lymphocytic lymphoma will include many of the studies ([Table 15-11](#)) that are used in patients with other non-Hodgkin's lymphomas. In addition, particular attention needs to be given to detecting immune abnormalities such as autoimmune hemolytic anemia, autoimmune thrombocytopenia, hypogammaglobulinemia, and red cell aplasia. Molecular analysis of immunoglobulin gene sequences in CLL has demonstrated that about half the patients have tumors expressing mutated immunoglobulin genes and half have tumors expressing unmutated or germ-line immunoglobulin sequences. Patients with unmutated immunoglobulins tend to have a more aggressive clinical course and are less responsive to therapy. Unfortunately, immunoglobulin gene sequencing is not routinely available. CD38 expression is said to be low in the better-prognosis patients expressing mutated immunoglobulin and high in poorer-prognosis patients expressing unmutated immunoglobulin, but this test has not been confirmed as a reliable means of distinguishing the two groups. ZAP-70 expression correlates with the presence of unmutated immunoglobulin genes, but the assay is not yet standardized and widely available.

#### Treatment:

#### **Rx B CELL CHRONIC LYMPHOID LEUKEMIA/SMALL LYMPHOCYTIC LYMPHOMA**

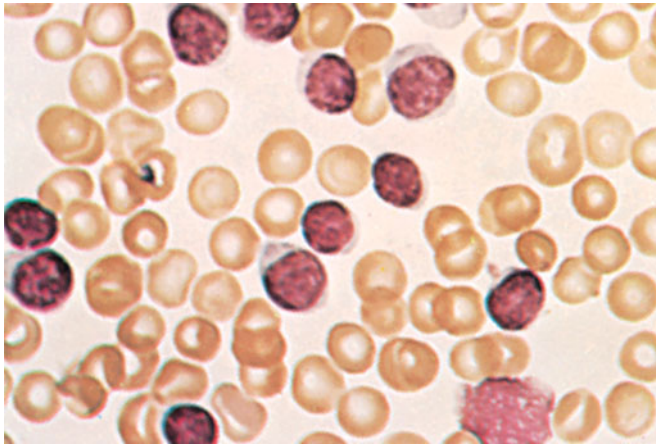
Patients whose presentation is typical B cell CLL with no manifestations of the disease other than bone marrow involvement and lymphocytosis (i.e., Rai stage O and Binet stage A; [Table 15-7](#)) can be followed without specific therapy for their malignancy. These patients have a median survival  $>10$  years, and some will never require therapy for this disorder. If the patient has an adequate number of circulating normal blood cells and is asymptomatic, many physicians would not initiate therapy for patients in the intermediate stage of the disease manifested by lymphadenopathy and/or hepatosplenomegaly. However, the median survival for these patients is ~7 years, and most will require treatment in the first few

**TABLE 15-10**

**CLINICAL CHARACTERISTICS OF PATIENTS WITH COMMON TYPES OF NON-HODGKIN'S LYMPHOMAS (NHL)**

DISEASE	MEDIAN AGE, YEARS	FREQUENCY IN CHILDREN	% MALE	STAGE I/II VS III/IV, %	B SYMPTOMS, %	BONE MARROW INVOLVEMENT, %	GASTROINTESTINAL TRACT INVOLVEMENT, %	% SURVIVING 5 YEARS
B cell chronic lymphocytic leukemia/small lymphocytic lymphoma	65	Rare	53	9 vs 91	33	72	3	51
Mantle cell lymphoma	63	Rare	74	20 vs 80	28	64	9	27
Extranodal marginal zone B cell lymphoma of MALT type	60	Rare	48	67 vs 33	19	14	50	74
Follicular lymphoma	59	Rare	42	33 vs 67	28	42	4	72
Diffuse large B cell lymphoma	64	~25% of childhood NHL	55	54 vs 46	33	16	18	46
Burkitt's lymphoma	31	~30% of childhood NHL	89	62 vs 38	22	33	11	45
Precursor T cell lymphoblastic lymphoma	28	~40% of childhood NHL	64	11 vs 89	21	50	4	26
Anaplastic large T/null cell lymphoma	34	Common	69	51 vs 49	53	13	9	77
Peripheral T cell non-Hodgkin's lymphoma	61	~5% of childhood NHL	55	20 vs 80	50	36	15	25

**Note:** MALT, mucosa-associated lymphoid tissue.

**FIGURE 15-6**

**Chronic lymphocytic leukemia.** The peripheral white blood cell count is high due to increased numbers of small, well-differentiated, normal-appearing lymphocytes. The leukemia lymphocytes are fragile, and substantial numbers of broken, smudged cells are usually also present on the blood smear.

years of follow-up. Patients who present with bone marrow failure (i.e., Rai stage III or IV or Binet stage C) will require initial therapy in almost all cases. These patients have a serious disorder with a median survival of only 1.5 years. It must be remembered that immune manifestations of typical B cell CLL should be managed independently of specific antileukemia therapy. For example, glucocorticoid therapy for autoimmune cytopenias and  $\gamma$  globulin replacement for patients with

**TABLE 15-11**

#### STAGING EVALUATION FOR NON-HODGKIN'S LYMPHOMA

Physical examination
Documentation of B symptoms
Laboratory evaluation
Complete blood counts
Liver function tests
Uric acid
Calcium
Serum protein electrophoresis
Serum $\beta_2$ -microglobulin
Chest radiograph
CT scan of abdomen, pelvis, and usually chest
Bone marrow biopsy
Lumbar puncture in lymphoblastic, Burkitt's, and diffuse large B cell lymphoma with positive marrow biopsy
Gallium scan (SPECT) or PET scan in large cell lymphoma

**Note:** SPECT, single-photon emission CT; PET, positron emission tomography.

hypogammaglobulinemia should be used whether or not antileukemia therapy is given.

Patients who present primarily with lymphoma and have a low IPI score have a 5-year survival of ~75%, but those with a high IPI score have a 5-year survival of <40% and are more likely to require early therapy.

The most common treatments for patients with typical B cell CLL/small lymphocytic lymphoma have been chlorambucil or fludarabine, alone or in combination. Chlorambucil can be administered orally with few immediate side effects; fludarabine is administered IV and associated with significant immune suppression. However, fludarabine is by far the more active agent and is the only drug associated with a significant incidence of complete remission. The combination of rituximab (375–500 mg/m<sup>2</sup> day 1), fludarabine (25 mg/m<sup>2</sup> days 2–4 on cycle 1 and 1–3 in subsequent cycles), and cyclophosphamide (250 mg/m<sup>2</sup> with fludarabine) achieves complete responses in 69% of patients, and those responses are associated with molecular remissions in half of the cases. Half the patients experience grade III or IV neutropenia. For young patients presenting with leukemia requiring therapy, regimens containing fludarabine are the treatment of choice. Because fludarabine is an effective second-line agent in patients with tumors unresponsive to chlorambucil, the latter agent is often chosen in elderly patients who require therapy. Many patients who present with lymphoma receive a combination chemotherapy regimen used in other lymphomas such as CVP (cyclophosphamide, vincristine, and prednisone) or CHOP, although fludarabine-containing regimens may be preferable. Alemtuzumab (anti-CD52) is an antibody with activity in the disease, but it kills both B and T cells and is associated with more immune compromise than rituximab. Young patients with this disease can be candidates for bone marrow transplantation. Allogeneic bone marrow transplantation can be curative but is associated with a significant treatment-related mortality. Mini-transplants using immunosuppressive rather than myeloablative doses of preparative drugs are being studied (Chap. 29). The use of autologous transplantation in patients with this disorder has been discouraging.

#### **Extranodal Marginal Zone B Cell Lymphoma of MALT Type**

Extranodal marginal zone B cell lymphoma of MALT type (MALT lymphoma) makes up ~8% of non-Hodgkin's lymphomas. This small cell lymphoma presents in extranodal sites. It was previously considered a small lymphocytic lymphoma or sometimes a pseudolymphoma. The recognition that the gastric presentation of this lymphoma was associated with *H. pylori* infection was an

important step in recognizing it as a separate entity. The clinical characteristics of MALT lymphoma are presented in Table 15-10.

The diagnosis of MALT lymphoma can be made accurately by an expert hematopathologist based on a characteristic pattern of infiltration of small lymphocytes that are monoclonal B cells and CD5 negative. In some cases, transformation to diffuse large B cell lymphoma occurs, and both diagnoses may be made in the same biopsy. The differential diagnosis includes benign lymphocytic infiltration of extranodal organs and other small cell B cell lymphomas.

MALT lymphoma may occur in the stomach, orbit, intestine, lung, thyroid, salivary gland, skin, soft tissues, bladder, kidney, and CNS. It may present as a new mass, be found on routine imaging studies, or be associated with local symptoms such as upper abdominal discomfort in gastric lymphoma. Most MALT lymphomas are gastric in origin. At least two genetic forms of gastric MALT exist: one (accounting for ~50% of cases) characterized by t(11;18)(q21;q21) that juxtaposes the amino terminal of the *API2* gene with the carboxy terminal of the *MALT1* gene creating an API2/MALT1 fusion product, and the other characterized by multiple sites of genetic instability including trisomies of chromosomes 3, 7, 12, and 18. About 95% of gastric MALT lymphomas are associated with *H. pylori* infection, and those that do not usually express t(11;18). The t(11;18) usually results in activation of NF- $\kappa$ B, which acts a survival factor for the cells. Lymphomas with t(11;18) translocations are genetically stable and do not evolve to diffuse large B cell lymphoma. By contrast, t(11;18)-negative MALT lymphomas often acquire *BCL6* mutations and progress to aggressive histology lymphoma. MALT lymphomas are localized to the organ of origin in ~40% of cases and to the organ and regional lymph nodes in ~30% of patients. However, distant metastasis can occur—particularly with transformation to diffuse large B cell lymphoma. Many patients who develop this lymphoma have an autoimmune or inflammatory process such as Sjögren's syndrome (salivary gland MALT), Hashimoto's thyroiditis (thyroid MALT), *Helicobacter* gastritis (gastric MALT), *C. psittaci* conjunctivitis (ocular MALT), or *Borrelia* skin infections (cutaneous MALT).

Evaluation of patients with MALT lymphoma follows the pattern (Table 15-11) for staging a patient with non-Hodgkin's lymphoma. In particular, patients with gastric lymphoma need to have studies performed to document the presence or absence of *H. pylori* infection. Endoscopic studies including ultrasound can help define the extent of gastric involvement. Most patients with MALT lymphoma have a good prognosis, with a 5-year survival of ~75%. In patients with a low IPI score, the 5-year survival is ~90%; it drops to ~40% in patients with a high IPI score.

### **Rx Treatment:** **MUCOSA-ASSOCIATED LYMPHOID TISSUE LYMPHOMA**

MALT lymphoma is often localized. Local therapy such as radiation or surgery can effect cure, and this is one of the few times where surgery might be a reasonable primary therapy for a patient with non-Hodgkin's lymphoma. Patients with gastric MALT lymphomas who are infected with *H. pylori* can achieve remission in most cases with eradication of the infection. These remissions can be durable, but molecular evidence of persisting neoplasia is frequent and the long-term outcome is uncertain. Patients who present with more extensive disease are most often treated with single-agent chemotherapy such as chlorambucil. Data on combination regimens that include rituximab are being generated, but its efficacy in other B cell tumors and low toxicity support its use. Co-existent diffuse large B cell lymphoma must be treated with combination chemotherapy (see later). The additional acquired mutations that mediate the histologic progression also convey *Helicobacter* independence to the growth.

### **Mantle Cell Lymphoma**

Mantle cell lymphoma makes up ~6% of all non-Hodgkin's lymphomas. This lymphoma was previously placed in a number of other subtypes. Its existence was confirmed by the recognition that these lymphomas have a characteristic chromosomal translocation, t(11;14), between the immunoglobulin heavy chain gene on chromosome 14 and the *bcl-1* gene on chromosome 11, and regularly overexpress the BCL-1 protein, also known as cyclin D1. Table 15-10 shows the clinical characteristics of mantle cell lymphoma.

The diagnosis of mantle cell lymphoma can be made accurately by an expert hematopathologist. As with all subtypes of lymphoma, an adequate biopsy is important. The differential diagnosis of mantle cell lymphoma includes other small cell B cell lymphomas. In particular, mantle cell lymphoma and small lymphocytic lymphoma share a characteristic expression of CD5. Mantle cell lymphoma usually has a slightly indented nucleus.

The most common presentation of mantle cell lymphoma is with palpable lymphadenopathy, frequently accompanied by systemic symptoms. Approximately 70% of patients are stage IV at the time of diagnosis, with frequent bone marrow and peripheral blood involvement. Of the extranodal organs that can be involved, gastrointestinal involvement is particularly important to recognize. Patients who present with lymphomatous polyposis in the large intestine usually have mantle cell lymphoma. Table 15-11 outlines the evaluation of patients with

mantle cell lymphoma. Patients who present with gastrointestinal tract involvement often have Waldeyer's ring involvement, and vice versa. The 5-year survival for all patients with mantle cell lymphoma is ~25%, with only occasional patients who present with a high IPI score surviving 5 years and ~50% of patients with a low IPI score surviving 5 years.

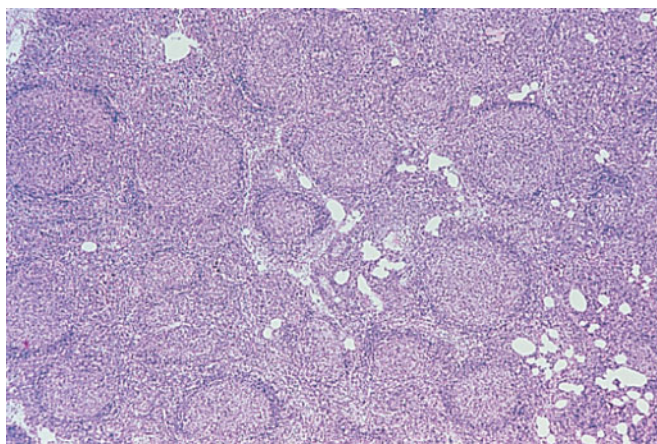
### **Rx Treatment:** **MANTLE CELL LYMPHOMA**

Current therapies for mantle cell lymphoma are unsatisfactory. Patients with localized disease might be treated with combination chemotherapy followed by radiotherapy; however, these patients are exceedingly rare. For the usual presentation with disseminated disease, treatments have been unsatisfactory, with the minority of patients achieving complete remission. Aggressive combination chemotherapy regimens followed by autologous or allogeneic bone marrow transplantation are frequently offered to younger patients. For the occasional elderly, asymptomatic patient, observation followed by single-agent chemotherapy might be the most practical approach. An intensive combination chemotherapy regimen originally used in the treatment of acute leukemia, HyperC-VAD (cyclophosphamide, vincristine, doxorubicin, dexamethasone, cytarabine, and methotrexate), in combination with rituximab seems to be associated with better response rates—particularly in younger patients. CHOP plus rituximab has shown better response rates than CHOP alone, but long-term follow-up is lacking. Bortezomib induces transient partial responses in a minority of patients.

### **Follicular Lymphoma**

Follicular lymphomas make up 22% of non-Hodgkin's lymphomas worldwide and at least 30% of non-Hodgkin's lymphomas diagnosed in the United States. This type of lymphoma can be diagnosed accurately on morphologic findings alone and has been the diagnosis in most patients in therapeutic trials for "low-grade" lymphoma in the past. The clinical characteristics of follicular lymphoma are presented in Table 15-10.

Evaluation of an adequate biopsy by an expert hematopathologist is sufficient to make a diagnosis of follicular lymphoma. The tumor is composed of small cleaved and large cells in varying proportions organized in a follicular pattern of growth (Fig. 15-7). Confirmation of B cell immunophenotype and the existence of the t(14;18) and abnormal expression of BCL-2 protein are confirmatory. The major differential diagnosis is between lymphoma and reactive follicular hyperplasia. The coexistence of diffuse large B cell lymphoma must



**FIGURE 15-7**

**Follicular lymphoma.** The normal nodal architecture is effaced by nodular expansions of tumor cells. Nodules vary in size and contain predominantly small lymphocytes with cleaved nuclei along with variable numbers of larger cells with vesicular chromatin and prominent nucleoli.

be considered. Patients with follicular lymphoma are often subclassified into those with predominantly small cells, those with a mixture of small and large cells, and those with predominantly large cells. Although this distinction cannot be made simply or very accurately, these subdivisions do have prognostic significance. Patients with follicular lymphoma with predominantly large cells have a higher proliferative fraction, progress more rapidly, and have a shorter overall survival with simple chemotherapy regimens.

The most common presentation for follicular lymphoma is with new, painless lymphadenopathy. Multiple sites of lymphoid involvement are typical, and unusual sites such as epitrochlear nodes are sometimes seen. However, essentially any organ can be involved, and extranodal presentations do occur. Most patients do not have fevers, sweats, or weight loss, and an IPI score of 0 or 1 is found in ~50% of patients. Fewer than 10% of patients have a high (i.e., 4 or 5) IPI score. The staging evaluation for patients with follicular lymphoma should include the studies included in Table 15-11.

### **Rx Treatment:** **FOLLICULAR LYMPHOMA**

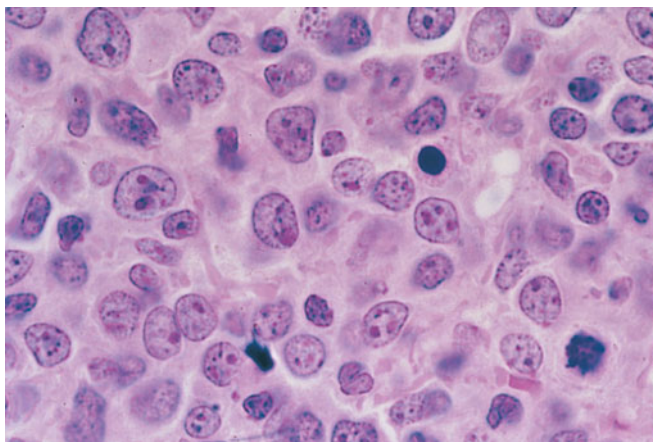
Follicular lymphoma is one of the malignancies most responsive to chemotherapy and radiotherapy. In addition, tumors in as many as 25% of the patients undergo spontaneous regression—usually transient—without therapy. In an asymptomatic patient, no initial treatment and watchful waiting can be an appropriate management strategy and is particularly likely to be adopted for older patients with advanced stage disease. For patients who do require treatment, single-agent chlorambucil or

cyclophosphamide or combination chemotherapy with CVP or CHOP are most frequently used. With adequate treatment, 50–75% of patients achieve a complete remission. Although most patients relapse (median response duration is ~2 years), at least 20% of complete responders remain in remission for >10 years. For the rare patient (15%) with localized follicular lymphoma, involved field radiotherapy produces long-term disease-free survival in the majority.

A number of therapies have been shown to be active in the treatment of patients with follicular lymphoma. These include cytotoxic agents such as fludarabine, and biologic agents such as interferon  $\alpha$ , monoclonal antibodies with or without radionuclides, and lymphoma vaccines. In patients treated with a doxorubicin-containing combination chemotherapy regimen, interferon  $\alpha$  given to patients in complete remission seems to prolong survival. The monoclonal antibody rituximab can cause objective responses in 35–50% of patients with relapsed follicular lymphoma, and radiolabeled antibodies appear to have response rates well in excess of 50%. The addition of rituximab to CHOP and other effective combination chemotherapy programs is beginning to show prolonged overall survival and a decreased risk of histologic progression. Trials with tumor vaccines have been encouraging. Both autologous and allogeneic hematopoietic stem cell transplantation yield high complete response rates in patients with relapsed follicular lymphoma, and long-term remissions can occur.

Patients with follicular lymphoma with a predominance of large cells have a shorter survival when treated with single-agent chemotherapy but seem to benefit from receiving an anthracycline-containing combination chemotherapy regimen plus rituximab. When their disease is treated aggressively, the overall survival for such patients is no lower than for patients with other follicular lymphomas, and the failure-free survival is superior.

Patients with follicular lymphoma have a high rate of histologic transformation to diffuse large B cell lymphoma (5–7% per year). This is recognized ~40% of the time during the course of the illness by repeat biopsy and is present in almost all patients at autopsy. This transformation is usually heralded by rapid growth of lymph nodes—often localized—and the development of systemic symptoms such as fevers, sweats, and weight loss. Although these patients have a poor prognosis, aggressive combination chemotherapy regimens can sometimes cause a complete remission in the diffuse large B cell lymphoma, at times leaving the patient with persisting follicular lymphoma.



**FIGURE 15-8**  
**Diffuse large B cell lymphoma.** The neoplastic cells are heterogeneous but predominantly large cells with vesicular chromatin and prominent nucleoli.

a third of all cases. This lymphoma makes up most cases in previous clinical trials of “aggressive” or “intermediate-grade” lymphoma. Table 15-10 shows the clinical characteristics of diffuse large B cell lymphoma.

The diagnosis of diffuse large B cell lymphoma can be made accurately by an expert hematopathologist (Fig. 15-8). Cytogenetic and molecular genetic studies are not necessary for diagnosis, but some evidence has accumulated that patients whose tumors overexpress the BCL-2 protein might be more likely to relapse than others. Patients with prominent mediastinal involvement are sometimes diagnosed as a separate subgroup having primary mediastinal diffuse large B cell lymphoma. This latter group of patients has a younger median age (i.e., 37 years) and a female predominance (66%). Subtypes of diffuse large B cell lymphoma, including those with an immunoblastic subtype and tumors with extensive fibrosis, are recognized by pathologists but do not appear to have important independent prognostic significance.

Diffuse large B cell lymphoma can present as either primary lymph node disease or at extranodal sites. More than 50% of patients have some site of extranodal involvement at diagnosis, with the most common sites the gastrointestinal tract and bone marrow, each being involved in 15–20% of patients. Essentially any organ can be involved, making a diagnostic biopsy imperative. For example, diffuse large B cell lymphoma of the pancreas has a much better prognosis than pancreatic carcinoma but would be missed without biopsy. Primary diffuse large B cell lymphoma of the brain is being diagnosed with increasing frequency. Other unusual subtypes of diffuse large B cell lymphoma such as pleural effusion lymphoma and intravascular lymphoma have been difficult to diagnose and associated with a very poor prognosis.

Table 15-11 shows the initial evaluation of patients with diffuse large B cell lymphoma. After a careful staging

### **Diffuse Large B Cell Lymphoma**

Diffuse large B cell lymphoma is the most common type of non-Hodgkin’s lymphoma, representing approximately

198 evaluation, ~50% of patients are found to have stage I or II disease and ~50% have widely disseminated lymphoma. Bone marrow biopsy shows involvement by lymphoma in ~15% of cases, with marrow involvement by small cells more frequent than by large cells.

**Rx Treatment:**  
**DIFFUSE LARGE B CELL LYMPHOMA**

The initial treatment of all patients with diffuse large B cell lymphoma should be with a combination chemotherapy regimen. The most popular regimen in the United States is CHOP plus rituximab, although a variety of other anthracycline-containing combination chemotherapy regimens appear to be equally efficacious. Patients with stage I or nonbulky stage II can be effectively treated with three to four cycles of combination chemotherapy followed by involved field radiotherapy. The need for radiation therapy is unclear. Cure rates of 70–80% in stage II disease and 85–90% in stage I disease can be expected.

For patients with bulky stage II, stage III, or stage IV disease, six to eight cycles of CHOP plus rituximab are usually administered. A large randomized trial showed the superiority of CHOP combined with rituximab over CHOP alone in elderly patients. A frequent approach would be to administer four cycles of therapy and then reevaluate. If the patient has achieved a complete remission after four cycles, two more cycles of treatment might be given and then therapy discontinued. Using this approach, 70–80% of patients can be expected to achieve a complete remission, and 50–70% of complete responders will be cured. The chances for a favorable response to treatment are predicted by the IPI. In fact, the IPI was developed based on the outcome of patients with diffuse large B cell lymphoma treated with CHOP-like regimens. For the 35% of patients with a low IPI score of 0–1, the 5-year survival is >70%; for the 20% of patients with a high IPI score of 4–5, the 5-year survival is ~20%. The addition of rituximab to CHOP has improved each of those numbers by ~15%. A number of other factors, including molecular features of the tumor, levels of circulating cytokines and soluble receptors, and other surrogate markers, have been shown to influence prognosis. However, they have not been validated as rigorously as the IPI and have not been uniformly applied clinically.

Because a number of patients with diffuse large B cell lymphoma are either initially refractory to therapy or relapse after apparently effective chemotherapy, 30–40% of patients are candidates for salvage treatment at some point. Alternative combination chemotherapy regimens can induce complete remission in as many as 50% of these patients, but long-term disease-free survival is seen

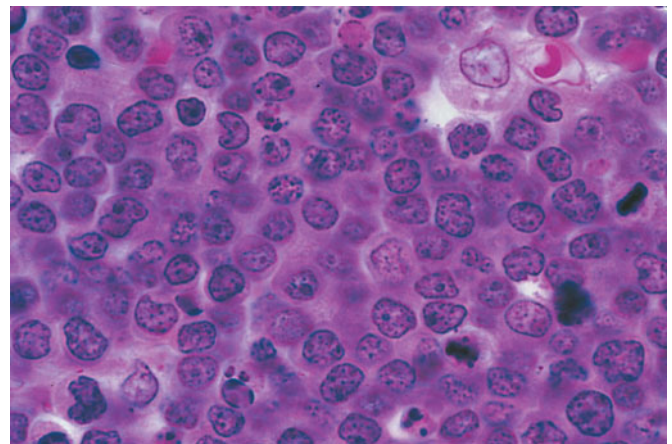
in ≤10%. Autologous bone marrow transplantation is superior to salvage chemotherapy at usual doses and leads to long-term disease-free survival in ~40% of patients whose lymphomas remain chemotherapy-sensitive after relapse.

### Burkitt's Lymphoma/Leukemia

Burkitt's lymphoma/leukemia is a rare disease in adults in the United States, making up <1% of non-Hodgkin's lymphomas, but it makes up ~30% of childhood non-Hodgkin's lymphoma. Burkitt's leukemia, or L3 ALL, makes up a small proportion of childhood and adult acute leukemias. Table 15-10 shows the clinical features of Burkitt's lymphoma.

Burkitt's lymphoma can be diagnosed morphologically by an expert hematopathologist with a high degree of accuracy. The cells are homogeneous in size and shape (Fig. 15-9). Demonstration of a very high proliferative fraction and the presence of the t(8;14) or one of its variants, t(2;8) (*c-myc* and the  $\lambda$  light chain gene) or t(8;22) (*c-myc* and the  $\kappa$  light chain gene), can be confirmatory. Burkitt's cell leukemia is recognized by the typical monotonous mass of medium-sized cells with round nuclei, multiple nucleoli, and basophilic cytoplasm with cytoplasmic vacuoles. Demonstration of surface expression of immunoglobulin and one of the previously noted cytogenetic abnormalities is confirmatory.

Three distinct clinical forms of Burkitt's lymphoma are recognized; endemic, sporadic, and immunodeficiency-associated. Endemic and sporadic Burkitt's lymphomas occur frequently in children in Africa, and the sporadic



**FIGURE 15-9**  
**Burkitt's lymphoma.** The neoplastic cells are homogenous, medium-sized B cells with frequent mitotic figures, a morphologic correlate of high growth fraction. Reactive macrophages are scattered through the tumor, and their pale cytoplasm in a background of blue-staining tumor cells give the tumor a so-called starry sky appearance.

form in Western countries. Immunodeficiency-associated Burkitt's lymphoma is seen in patients with HIV infection.

Pathologists sometimes have difficulty distinguishing between Burkitt's lymphoma and diffuse large B cell lymphoma. In the past, a separate subgroup of non-Hodgkin's lymphoma intermediate between the two was recognized. When tested, this subgroup could not be diagnosed accurately. Distinction between the two major types of B cell aggressive non-Hodgkin's lymphoma can sometimes be made based on the extremely high proliferative fraction seen in patients with Burkitt's lymphoma (i.e., essentially 100% of tumor cells are in cycle) caused by *c-myc* deregulation.

Most patients in the United States with Burkitt's lymphoma present with peripheral lymphadenopathy or an intraabdominal mass. The disease is rapidly progressive and has a propensity to metastasize to the CNS. Initial evaluation should always include an examination of cerebral spinal fluid to rule out metastasis in addition to the other staging evaluations noted in Table 15-11. Once the diagnosis of Burkitt's lymphoma is suspected, a diagnosis must be made promptly and staging evaluation must be accomplished expeditiously. This is the most rapidly progressive human tumor, and any delay in initiating therapy can adversely affect the patient's prognosis.

### **Rx** Treatment: **BURKITT'S LYMPHOMA**

Treatment of Burkitt's lymphoma in both children and adults should begin within 48 h of diagnosis and involves the use of intensive combination chemotherapy regimens incorporating high doses of cyclophosphamide. Prophylactic therapy to the CNS is mandatory. Burkitt's lymphoma was one of the first cancers shown to be curable by chemotherapy. Today, cure can be expected in 70–80% of both children and young adults when effective therapy is administered precisely. Salvage therapy has been generally ineffective in patients failing the initial treatment, emphasizing the importance of the initial treatment approach.

### **Other B Cell Lymphoid Malignancies**

*B cell prolymphocytic leukemia* involves blood and marrow infiltration by large lymphocytes with prominent nucleoli. Patients typically have a high white cell count, splenomegaly, and minimal lymphadenopathy. The chances for a complete response to therapy are poor.

*Hairy cell leukemia* is a rare disease that presents predominantly in older males. Typical presentation involves pancytopenia, although occasional patients have a leukemic presentation. Splenomegaly is usual. The malignant cells

appear to have “hairy” projections on light and electron microscopy and show a characteristic staining pattern with tartrate-resistant acid phosphatase. Bone marrow is typically not able to be aspirated, and biopsy shows a pattern of fibrosis with diffuse infiltration by the malignant cells. Patients with this disorder are prone to unusual infections, including infection by *Mycobacterium avium intracellulare*, and to vasculitic syndromes. Hairy cell leukemia is responsive to chemotherapy with interferon  $\gamma$ , pentostatin, or cladribine, with the latter being the usually preferred treatment. Clinical complete remissions with cladribine occur in most patients, and long-term disease-free survival is frequent.

*Splenic marginal zone lymphoma* involves infiltration of the splenic white pulp by small monoclonal B cells. This is a rare disorder that can present as leukemia as well as lymphoma. Definitive diagnosis is often made at splenectomy, which is also an effective therapy. This is an extremely indolent disorder, but when chemotherapy is required, the most usual treatment has been chlorambucil.

*Lymphoplasmacytic lymphoma* is the tissue manifestation of Waldenström's macroglobulinemia (Chap. 16). This type of lymphoma has been associated with chronic hepatitis C virus infection, and an etiologic association has been proposed. Patients typically present with lymphadenopathy, splenomegaly, bone marrow involvement, and occasionally peripheral blood involvement. The tumor cells do not express CD5. Patients often have a monoclonal IgM protein, high levels of which can dominate the clinical picture with the symptoms of hyperviscosity. Treatment of lymphoplasmacytic lymphoma can be aimed primarily at reducing the abnormal protein, if present, but usually also involve chemotherapy. Chlorambucil, fludarabine, and cladribine have been used. The median 5-year survival for patients with this disorder is ~60%.

*Nodal marginal zone lymphoma*, also known as *monocytoid B cell lymphoma*, represents ~1% of non-Hodgkin's lymphomas. This lymphoma has a slight female predominance and presents with disseminated disease (i.e., stage III or IV) in 75% of patients. Approximately a third of patients have bone marrow involvement, and a leukemic presentation occasionally occurs. The staging evaluation and therapy should use the same approach as used for patients with follicular lymphoma. Approximately 60% of the patients with nodal marginal zone lymphoma survive 5 years after diagnosis.

### **PRECURSOR CELL T CELL MALIGNANCIES**

#### **Precursor T Cell Lymphoblastic Leukemia/Lymphoma**

Precursor T cell malignancies can present either as ALL or as an aggressive lymphoma. These malignancies are more common in children and young adults, with males more frequently affected than females.



Precursor T cell ALL can present with bone marrow failure, although the severity of anemia, neutropenia, and thrombocytopenia is often less than in precursor B cell ALL. These patients sometimes have very high white cell counts, a mediastinal mass, lymphadenopathy, and hepatosplenomegaly. Precursor T cell lymphoblastic lymphoma is most often found in young men presenting with a large mediastinal mass and pleural effusions. Both presentations have a propensity to metastasize to the CNS, and CNS involvement is often present at diagnosis.

**Rx Treatment:**  
**PRECURSOR T CELL LYMPHOBLASTIC LEUKEMIA/LYMPHOMA**

Children with precursor T cell ALL seem to benefit from very intensive remission induction and consolidation regimens. Most patients treated in this manner can be cured. Older children and young adults with precursor T cell lymphoblastic lymphoma are also often treated with “leukemia-like” regimens. Patients who present with localized disease have an excellent prognosis. However, advanced age is an adverse prognostic factor. Adults with precursor T cell lymphoblastic lymphoma who present with high LDH levels or bone marrow or CNS involvement are often offered bone marrow transplantation as part of their primary therapy.

## MATURE (PERIPHERAL) T CELL DISORDERS

### *Mycosis Fungoides*

Mycosis fungoides is also known as *cutaneous T cell lymphoma*. This lymphoma is more often seen by dermatologists than internists. The median age of onset is in the mid-fifties, and the disease is more common in males and in blacks.

Mycosis fungoides is an indolent lymphoma with patients often having several years of eczematous or dermatitic skin lesions before the diagnosis is finally established. The skin lesions progress from patch stage to plaque stage to cutaneous tumors. Early in the disease, biopsies are often difficult to interpret, and the diagnosis may only become apparent by observing the patient over time. In advanced stages, the lymphoma can spread to lymph nodes and visceral organs. Patients with this lymphoma may develop generalized erythroderma and circulating tumor cells, called *Sézary’s syndrome*.

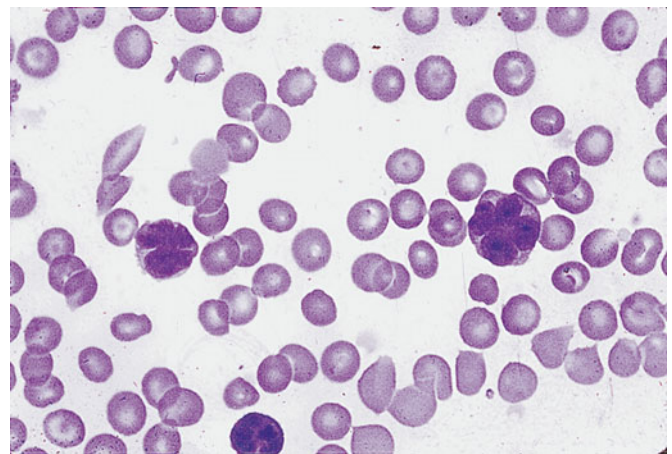
Rare patients with localized early stage mycosis fungoides can be cured with radiotherapy, often total-skin electron beam irradiation. More advanced disease has been treated with topical glucocorticoids, topical nitrogen mustard, phototherapy, psoralen with ultraviolet A (PUVA), electron beam radiation, interferon, antibodies, fusion toxins, and systemic cytotoxic therapy. Unfortunately, these treatments are only palliative.

## Adult T Cell Lymphoma/Leukemia

Adult T cell lymphoma/leukemia is one manifestation of infection by the HTLV-I retrovirus. Patients can be infected through transplacental transmission, mother’s milk, blood transfusion, and by sexual transmission of the virus. Patients who acquire the virus from their mother through breast milk are most likely to develop lymphoma, but the risk is still only 2.5% and the latency averages 55 years. Nationwide testing for HTLV-I antibodies and the aggressive implementation of public health measures could theoretically lead to the disappearance of adult T cell lymphoma/leukemia. Tropical spastic paraparesis, another manifestation of HTLV-I infection, occurs after a shorter latency (1–3 years) and is most common in individuals who acquire the virus during adulthood from transfusion or sex.

The diagnosis of adult T cell lymphoma/leukemia is made when an expert hematopathologist recognizes the typical morphologic picture, a T cell immunophenotype (i.e., CD4 positive), and the presence in serum of antibodies to HTLV-I. Examination of the peripheral blood usually reveals characteristic, pleomorphic abnormal CD4-positive cells with indented nuclei, which have been called “flower” cells (**Fig. 15-10**).

A subset of patients has a smoldering clinical course and long survival, but most patients present with an aggressive disease manifested by lymphadenopathy, hepatosplenomegaly, skin infiltration, pulmonary infiltrates, hypercalcemia, lytic bone lesions, and elevated LDH levels. The skin lesions can be papules, plaques, tumors, and ulcerations. Lung lesions can be either tumor or opportunistic infection in light of the underlying immunodeficiency in the disease. Bone marrow involvement is not usually extensive, and anemia and thrombocytopenia are not usually prominent. Although



**FIGURE 15-10**  
**Adult T cell leukemia/lymphoma.** Peripheral blood smear showing leukemia cells with typical “flower-shaped” nucleus.

treatment by combination chemotherapy regimens can result in objective responses, true complete remissions are unusual, and the median survival of patients is ~7 months.

### **Anaplastic Large T/Null Cell Lymphoma**

Anaplastic large T/null cell lymphoma was previously usually diagnosed as undifferentiated carcinoma or malignant histiocytosis. Discovery of the CD30 (Ki-1) antigen and the recognition that some patients with previously unclassified malignancies displayed this antigen led to the identification of a new type of lymphoma. Subsequently, discovery of the t(2;5) and the resultant frequent overexpression of the anaplastic lymphoma kinase (ALK) protein confirmed the existence of this entity. This lymphoma accounts for ~2% of all non-Hodgkin's lymphomas. Table 15-10 shows the clinical characteristics of patients with anaplastic large T/null cell lymphoma.

The diagnosis of anaplastic large T/null cell lymphoma is made when an expert hematopathologist recognizes the typical morphologic picture and a T cell or null cell immunophenotype with CD30 positivity. Documentation of the t(2;5) and/or overexpression of ALK protein confirm the diagnosis. Some diffuse large B cell lymphomas can also have an anaplastic appearance but have the same clinical course or response to therapy as other diffuse large B cell lymphomas.

Patients with anaplastic large T/cell null cell lymphoma are typically young (median age, 33 years) and male (~70%). Some 50% of patients present in stage I/II, and the remainder with more extensive disease. Systemic symptoms and elevated LDH levels are seen in about half of patients. Bone marrow and the gastrointestinal tract are rarely involved, but skin involvement is frequent. Some patients with disease confined to the skin have a different and more indolent disorder that has been termed *cutaneous anaplastic large T/null cell lymphoma* and might be related to lymphomatoid papulosis.

#### **Rx Treatment: ANAPLASTIC LARGE T/NULL CELL LYMPHOMA**

Treatment regimens appropriate for other aggressive lymphomas, such as diffuse large B cell lymphoma, should be used in patients with anaplastic large T/null cell lymphoma, with the exception that the B cell-specific antibody, rituximab, is omitted. Surprisingly, given the anaplastic appearance, this disorder has the best survival rate of any aggressive lymphoma. The 5-year survival is >75%. Although traditional prognostic factors such as the IPI predict treatment outcome, overexpression of the ALK protein is an important prognostic factor, with patients overexpressing this protein having a superior treatment outcome.

### **Peripheral T Cell Lymphoma**

The peripheral T cell lymphomas make up a heterogeneous morphologic group of aggressive neoplasms that share a mature T cell immunophenotype. They represent ~7% of all cases of non-Hodgkin's lymphoma. A number of distinct clinical syndromes are included in this group of disorders. Table 15-10 shows the clinical characteristics of patients with peripheral T cell lymphoma.

The diagnosis of peripheral T cell lymphoma, or any of its specific subtypes, requires an expert hematopathologist, an adequate biopsy, and immunophenotyping. Most peripheral T cell lymphomas are CD4+, but a few will be CD8+, both CD4+ and CD8+, or have an NK cell immunophenotype. No characteristic genetic abnormalities have yet been identified, but translocations involving the T cell antigen receptor genes on chromosomes 7 or 14 may be detected. The differential diagnosis of patients suspected of having peripheral T cell lymphoma includes reactive T cell infiltrative processes. In some cases, demonstration of a monoclonal T cell population using T cell receptor gene rearrangement studies is required to make a diagnosis.

The initial evaluation of a patient with a peripheral T cell lymphoma should include the studies in Table 15-11 for staging patients with non-Hodgkin's lymphoma. Unfortunately, patients with peripheral T cell lymphoma usually present with adverse prognostic factors, with >80% of patients having an IPI score  $\geq 2$  and >30% having an IPI score  $\geq 4$ . As this would predict, peripheral T cell lymphomas are associated with a poor outcome, and only 25% of the patients survive 5 years after diagnosis. Treatment regimens are the same as those used for diffuse large B cell lymphoma (omitting rituximab), but patients with peripheral T cell lymphoma have a poorer response to treatment. Because of this poor treatment outcome, hematopoietic stem cell transplantation is often considered early in the care of young patients.

A number of specific clinical syndromes are seen in the peripheral T cell lymphomas. *Angioimmunoblastic T cell lymphoma* is one of the more common subtypes, making up ~20% of T cell lymphomas. These patients typically present with generalized lymphadenopathy, fever, weight loss, skin rash, and polyclonal hypergammaglobulinemia. In some cases, it is difficult to separate patients with a reactive disorder from those with true lymphoma.

*Extranodal T/NK cell lymphoma of nasal type* has also been called *angiocentric lymphoma* and was previously termed *lethal midline granuloma*. This disorder is more frequent in Asia and South America than in the United States and Europe. EBV is thought to play an etiologic role. Although most frequent in the upper airway, it can involve other organs. The course is aggressive, and patients frequently have the hemophagocytic syndrome. When marrow and blood involvement occur, distinction between this disease and leukemia might be difficult. Some patients

202 respond to aggressive combination chemotherapy regimens, but the overall outlook is poor.

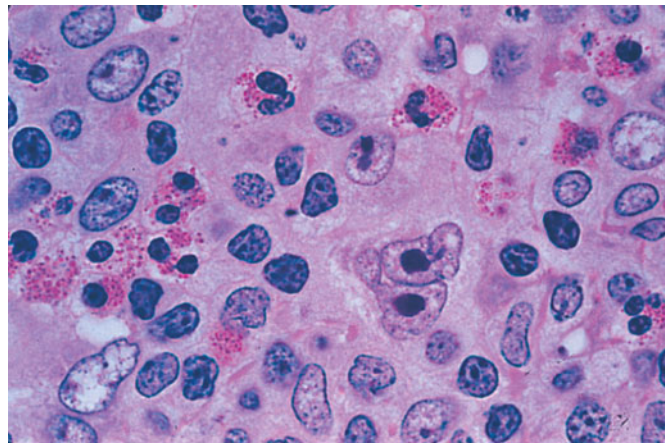
*Enteropathy-type intestinal T cell lymphoma* is a rare disorder that occurs in patients with untreated gluten-sensitive enteropathy. Patients are frequently wasted and sometimes present with intestinal perforation. The prognosis is poor. *Hepatosplenic  $\gamma\delta$  T cell lymphoma* is a systemic illness that presents with sinusoidal infiltration of the liver, spleen, and bone marrow by malignant T cells. Tumor masses generally do not occur. The disease is associated with systemic symptoms and is often difficult to diagnosis. Treatment outcome is poor. *Subcutaneous panniculitis-like T cell lymphoma* is a rare disorder that is often confused with panniculitis. Patients present with multiple subcutaneous nodules, which progress and can ulcerate. Hemophagocytic syndrome is common. Response to therapy is poor. The development of the hemophagocytic syndrome (profound anemia, ingestion of erythrocytes by monocytes and macrophages) in the course of any peripheral T cell lymphoma is generally associated with a fatal outcome.

## HODGKIN'S DISEASE

### Classical Hodgkin's Disease

Hodgkin's disease occurs in 8000 patients in the United States each year, and the disease does not appear to be increasing in frequency. Most patients present with palpable lymphadenopathy that is nontender; in most patients, these lymph nodes are in the neck, supraclavicular area, and axilla. More than half the patients have mediastinal adenopathy at diagnosis, and this is sometimes the initial manifestation. Subdiaphragmatic presentation of Hodgkin's disease is unusual and more common in older males. A third of patients present with fevers, night sweats, and/or weight loss—B symptoms in the Ann Arbor staging classification (Table 15-8). Occasionally, Hodgkin's disease can present as a fever of unknown origin. This is more common in older patients who are found to have mixed-cellularity Hodgkin's disease in an abdominal site. Rarely, the fevers persist for days to weeks, followed by afebrile intervals and then recurrence of the fever. This pattern is known as *Pel-Ebstein fever*. Hodgkin's disease can occasionally present with unusual manifestations. These include severe and unexplained itching, cutaneous disorders such as erythema nodosum and ichthyosiform atrophy, paraneoplastic cerebellar degeneration and other distant effects on the CNS, nephrotic syndrome, immune hemolytic anemia and thrombocytopenia, hypercalcemia, and pain in lymph nodes on alcohol ingestion.

The diagnosis of Hodgkin's disease is established by review of an adequate biopsy specimen by an expert hematopathologist. In the United States, most patients have nodular sclerosing Hodgkin's disease, with a minority



**FIGURE 15-11**

**Mixed cellularity Hodgkin's disease.** A Reed-Sternberg cell is present near the center of the field; a large cell with a bilobed nucleus and prominent nucleoli giving an "owl's eyes" appearance. Most of the cells are normal lymphocytes, neutrophils, and eosinophils that form a pleomorphic cellular infiltrate.

of patients having mixed-cellularity Hodgkin's disease. Lymphocyte-predominant and lymphocyte-depleted types of Hodgkin's disease are rare. Mixed-cellularity Hodgkin's disease or lymphocyte-depletion Hodgkin's disease are seen more frequently in patients infected by HIV (Fig. 15-11). The differential diagnosis of a lymph node biopsy suspicious for Hodgkin's disease includes inflammatory processes, mononucleosis, non-Hodgkin's lymphoma, phenytoin-induced adenopathy, and non-lymphomatous malignancies.

The staging evaluation for a patient with Hodgkin's disease would typically include a careful history and physical examination; complete blood count; erythrocyte sedimentation rate; serum chemistry studies including LDH; chest radiograph; CT scan of the chest, abdomen, and pelvis; and bone marrow biopsy. Many patients would also have a PET scan or a gallium scan. Although rarely used, a bipedal lymphangiogram can be helpful. PET and gallium scans are most useful to document remission. Staging laparotomies were once popular for most patients with Hodgkin's disease but are now done rarely because of an increased reliance on systemic rather than local therapy.



#### Treatment:

#### CLASSICAL HODGKIN'S DISEASE

Patients with localized Hodgkin's disease are cured >90% of the time. In patients with good prognostic factors, extended-field radiotherapy has a high cure rate. Increasingly, patients with all stages of Hodgkin's disease are treated initially with chemotherapy. Patients with localized

or good-prognosis disease receive a brief course of chemotherapy followed by radiotherapy to sites of node involvement. Patients with more extensive disease or those with B symptoms receive a complete course of chemotherapy. The most popular chemotherapy regimens used in Hodgkin's disease include doxorubicin, bleomycin, vinblastine, and dacarbazine (ABVD) and mechlorethamine, vincristine, procarbazine, and prednisone (MOPP), or combinations of the drugs in these two regimens. Today, most patients in the United States receive ABVD, but a weekly chemotherapy regimen administered for 12 weeks called *Stanford V* is becoming increasingly popular, but includes radiation therapy, which has been associated with life-threatening late toxicities such as premature coronary artery disease and second solid tumors. In Europe a high-dose regimen called *BEACOPP* incorporating alkylating agents has become popular and might have a better response rate in very high-risk patients. Long-term disease-free survival in patients with advanced disease can be achieved in >75% of patients who lack systemic symptoms and in 60–70% of patients with systemic symptoms.

Patients who relapse after primary therapy of Hodgkin's disease can frequently still be cured. Patients who relapse after initial treatment only with radiotherapy have an excellent outcome when treated with chemotherapy. Patients who relapse after an effective chemotherapy regimen are usually not curable with subsequent chemotherapy administered at standard doses. However, patients with a long initial remission can be an exception to this rule. Autologous bone marrow transplantation can cure half of patients who fail effective chemotherapy regimens.

Because of the very high cure rate in patients with Hodgkin's disease, long-term complications have become a major focus for clinical research. In fact, in some series of patients with early-stage disease, more patients died from late complications of therapy than from Hodgkin's disease itself. This is particularly true in patients with localized disease. The most serious late side effects include second malignancies and cardiac injury. Patients are at risk for the development of acute leukemia in the first 10 years after treatment with combination chemotherapy regimens that contain alkylating agents plus radiation therapy. The risk for development of acute leukemia appears to be greater after MOPP-like regimens than with ABVD. The risk of development of acute leukemia after treatment for Hodgkin's disease is also related to the number of exposures to potentially leukemogenic agents (i.e., multiple treatments after relapse) and the age of the patient being treated, with those >60 years at particularly high risk. The development of carcinomas as a complication of treatment for Hodgkin's disease has become a major problem. These tumors usually occur  $\geq 10$  years after treatment and are

associated with use of radiotherapy. For this reason, young women treated with thoracic radiotherapy for Hodgkin's disease should institute screening mammograms 5–10 years after treatment, and all patients who receive thoracic radiotherapy for Hodgkin's disease should be discouraged from smoking. Thoracic radiation also accelerates coronary artery disease, and patients should be encouraged to minimize risk factors for coronary artery disease such as smoking and elevated cholesterol levels.

A number of other late side effects from the treatment of Hodgkin's disease are well known. Patients who receive thoracic radiotherapy are at very high risk for the eventual development of hypothyroidism and should be observed for this complication; intermittent measurement of thyrotropin should be made to identify the condition before it becomes symptomatic. Lhermitte's syndrome occurs in ~15% of patients who receive thoracic radiotherapy. This syndrome is manifested by an "electric shock" sensation into the lower extremities on flexion of the neck. Infertility is a concern for all patients undergoing treatment for Hodgkin's disease. In both women and men, the risk of permanent infertility is age-related, with younger patients more likely to recover fertility. In addition, treatment with ABVD rather than MOPP increases the chances to retain fertility.

### **Nodular Lymphocyte-Predominant Hodgkin's Disease**

Nodular lymphocyte-predominant Hodgkin's disease is now recognized as an entity distinct from classical Hodgkin's disease. Previous classification systems recognized that biopsies from a subset of patients diagnosed as having Hodgkin's disease contained a predominance of small lymphocytes and rare Reed-Sternberg cells. A subset of these patients has tumors with nodular growth pattern and a clinical course that varied from that of patients with classical Hodgkin's disease. This is an unusual clinical entity and represents <5% of cases of Hodgkin's disease.

Nodular lymphocyte-predominant Hodgkin's disease has a number of characteristics that suggest its relationship to non-Hodgkin's lymphoma. These include a clonal proliferation of B cells and a distinctive immunophenotype; tumor cells express J chain and display CD45 and epithelial membrane antigen (ema) and do not express two markers normally found on Sternberg-Reed cells, CD30 and CD15. This lymphoma tends to have a chronic, relapsing course and sometimes transforms to diffuse large B cell lymphoma.

The treatment of patients with nodular lymphocyte-predominant Hodgkin's disease is controversial. Some clinicians favor no treatment and merely close follow-up.

In the United States, most physicians treat localized disease with radiotherapy and disseminated disease with regimens used for patients with classical Hodgkin's disease. Regardless of the therapy used, most series report a long-term survival of >80%.

## LYMPHOMA-LIKE DISORDERS

The most common condition that pathologists and clinicians might confuse with lymphoma is reactive, atypical lymphoid hyperplasia. Patients might have localized or disseminated lymphadenopathy and might have the systemic symptoms characteristic of lymphoma. Underlying causes include a drug reaction to phenytoin or carbamazepine. Immune disorders such as rheumatoid arthritis and lupus erythematosus, viral infections such as cytomegalovirus and EBV, and bacterial infections such as cat-scratch disease may cause adenopathy (Chap. 4). In the absence of a definitive diagnosis after initial biopsy, continued follow-up, further testing, and repeated biopsies, if necessary, are the appropriate approach rather than instituting therapy.

Specific conditions that can be confused with lymphoma include *Castleman's disease*, which can present with localized or disseminated lymphadenopathy; some patients have systemic symptoms. The disseminated form is often accompanied by anemia and polyclonal hypergammaglobulinemia, and the condition has been associated with overproduction of interleukin 6, possibly produced by human herpesvirus 8. Patients with localized disease can be treated effectively with local therapy; the initial treatment for patients with disseminated disease is usually with systemic glucocorticoids.

*Sinus histiocytosis with massive lymphadenopathy (Rosai-Dorfman's disease)* usually presents with bulky lymphadenopathy in children or young adults. The disease is usually nonprogressive and self-limited, but patients can manifest autoimmune hemolytic anemia.

*Lymphomatoid papulosis* is a cutaneous lymphoproliferative disorder that is often confused with anaplastic large cell lymphoma involving the skin. The cells of lymphomatoid papulosis are similar to those seen in lymphoma and

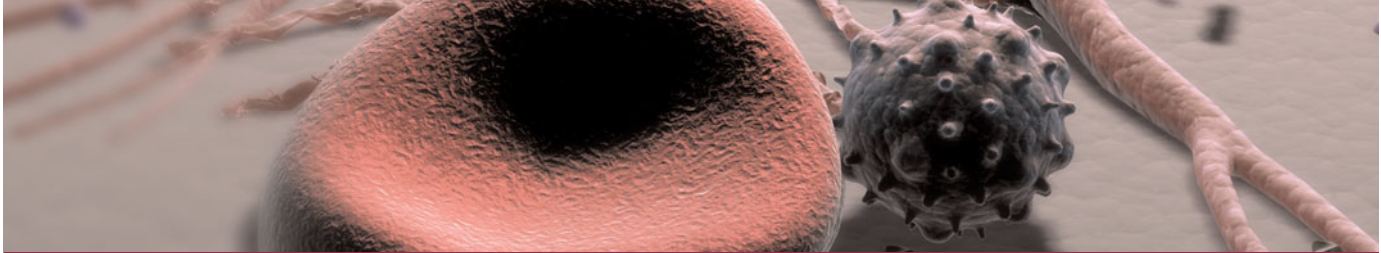
stain for CD30, and T cell receptor gene rearrangements are sometimes seen. However, the condition is characterized by waxing and waning skin lesions that usually heal, leaving small scars. In the absence of effective communication between the clinician and the pathologist regarding the clinical course in the patient, this disease will be misdiagnosed. Because the clinical picture is usually benign, misdiagnosis is a serious mistake.

### ACKNOWLEDGMENT

*James Armitage was a coauthor of this chapter in prior editions, and substantial material from those editions has been included here.*

### FURTHER READINGS

- ANSEL SM, ARMITAGE JO: Management of Hodgkin lymphoma. *Mayo Clin Proc* 81:419, 2006
- ARMITAGE JO et al: Lymphoma 2006: Classification and treatment. *Oncology* 20:231, 2006
- BREPOELS L et al: PET and PET/CT for response evaluation in lymphoma: Current practice and developments. *Leuk Lymphoma* 48:270, 2007
- DREYLING M, HIDDEMANN W: Dose-intense treatment of mantle cell lymphoma: Can durable remission be achieved? *Curr Opin Oncol* 20:487, 2008
- GRUBER F et al: Impact of tyrosine kinase inhibitors on patient outcomes in Philadelphia chromosome-positive acute lymphoblastic leukaemia. *Br J Haematol* 145:581, 2009
- HARRIS NL et al: World Health Organization classification of neoplastic diseases of the hematopoietic and lymphoid tissues: Report of the Clinical Advisory Committee Meeting, Airlie House, Virginia, November, 1997. *J Clin Oncol* 17:3835, 1999
- HERNANDEZ-ILIZALITURRI FJ, CZUCZMAN MS: Therapeutic options in relapsed or refractory diffuse large B-cell lymphoma. *Oncology* 23:546, 2009
- LONGO DL: Hodgkin's lymphoma: An overview. *Cancer J* 15:114, 2009
- QUINTAS-CARDAMA A, O'BRIEN S: Targeted therapy for chronic lymphocytic leukemia. *Target Oncol* 4:11, 2009
- SEHN LH et al: The revised International Prognostic Index (R-IPI) is a better predictor of outcome than the standard IPI for patients with diffuse large B-cell lymphoma treated with R-CHOP. *Blood* 109:1857, 2007
- URBA WJ, LONGO DL: Hodgkin's disease. *N Engl J Med* 326:678, 1992



## CHAPTER 16

# PLASMA CELL DISORDERS

Nikhil C. Munshi ■ Dan L. Longo ■ Kenneth C. Anderson

■ Multiple Myeloma . . . . .	206	■ POEMS Syndrome . . . . .	215
Definition . . . . .	206	■ Heavy Chain Diseases . . . . .	215
Etiology . . . . .	207	Gamma Heavy Chain Disease (Franklin's Disease) . . . . .	215
Incidence and Prevalence . . . . .	207	Alpha Heavy Chain Disease (Seligmann's Disease) . . . . .	215
Pathogenesis and Clinical Manifestations . . . . .	207	Mu Heavy Chain Disease . . . . .	216
Diagnosis and Staging . . . . .	210	■ Further Readings . . . . .	216
■ Waldenström's Macroglobulinemia . . . . .	214		

The *plasma cell disorders* are monoclonal neoplasms related to each other by virtue of their development from common progenitors in the B lymphocyte lineage. Multiple myeloma, Waldenström's macroglobulinemia, primary amyloidosis (Chap. 17), and the heavy chain diseases comprise this group and may be designated by a variety of synonyms such as *monoclonal gammopathies*, *paraproteinemias*, *plasma cell dyscrasias*, and *dysproteinemias*. Mature B lymphocytes destined to produce IgG bear surface immunoglobulin molecules of both M and G heavy chain isotypes with both isotypes having identical idiotypes (variable regions). Under normal circumstances, maturation to antibody-secreting plasma cells is stimulated by exposure to the antigen for which the surface immunoglobulin is specific; however, in the plasma cell disorders the control over this process is lost. The clinical manifestations of all the plasma cell disorders relate to the expansion of the neoplastic cells, to the secretion of cell products (immunoglobulin molecules or subunits, lymphokines), and to some extent to the host's response to the tumor.

Three categories of structural variation among immunoglobulin molecules form antigenic determinants, and these are used to classify immunoglobulins. *Isotypes* are those determinants that distinguish among the main classes of antibodies of a given species and are the same in all normal individuals of that species. Therefore, isotypic determinants are, by definition, recognized by antibodies from a distinct species (heterologous sera) but not by antibodies from the same species (homologous

sera). There are five heavy chain isotypes (M, G, A, D, E) and two light chain isotypes ( $\kappa$ ,  $\lambda$ ). *Allotypes* are distinct determinants that reflect regular small differences between individuals of the same species in the amino acid sequences of otherwise similar immunoglobulins. These differences are determined by allelic genes; by definition, they are detected by antibodies made in the same species. *Idiotypes* are the third category of antigenic determinants. They are unique to the molecules produced by a given clone of antibody-producing cells. Idiotypes are formed by the unique structure of the antigen-binding portion of the molecule.

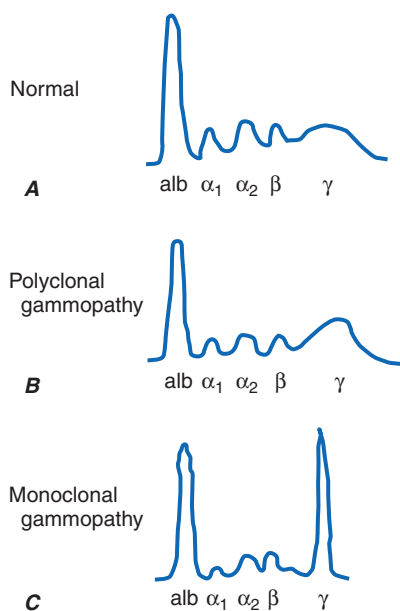
Antibody molecules are composed of two heavy chains (molecular weight ~50,000) and two light chains (molecular weight ~25,000). Each chain has a constant portion (limited amino acid sequence variability) and a variable region (extensive sequence variability). The light and heavy chains are linked by disulfide bonds and are aligned so that their variable regions are adjacent to one another. This variable region forms the antigen recognition site of the antibody molecule; its unique structural features form a particular set of determinants, or idiotypes, that are reliable markers for a particular clone of cells because each antibody is formed and secreted by a single clone. Each chain is specified by distinct genes, synthesized separately, and assembled into an intact antibody molecule after translation. Because of the mechanics of the gene rearrangements necessary to specify the immunoglobulin variable regions (VDJ joining for the heavy chain, VJ joining for the light chain), a

particular clone rearranges only one of the two chromosomes to produce an immunoglobulin molecule of only one light chain isotype and only one allotype (allelic exclusion). After exposure to antigen, the variable region may become associated with a new heavy chain isotype (class switch). Each clone of cells performs these sequential gene arrangements in a unique way. This results in each clone producing a unique immunoglobulin molecule. In most cells, light chains are synthesized in slight excess, are secreted as free light chains by plasma cells, and are cleared by the kidney, but <10 mg of such light chains is excreted per day.

Electrophoretic analysis of components of the serum proteins permits determination of the amount of immunoglobulin in the serum (Fig. 16-1). The immunoglobulins move heterogeneously in an electric field and form a broad peak in the gamma region. The  $\gamma$  globulin region of the electrophoretic pattern is usually increased in the sera of patients with plasma cell tumors. There is a sharp spike in this region called an *M component* (M for monoclonal). Less commonly, the M component may appear in the  $\beta_2$  or  $\alpha_2$  globulin region. The antibody must be present at a concentration of at least 5 g/L (0.5 g/dL) to be detectable by this method. This

corresponds to  $\sim 10^9$  cells producing the antibody. Confirmation that such an M component is truly monoclonal relies on the use of immunoelectrophoresis that shows a single light and heavy chain type. Hence immunoelectrophoresis and electrophoresis provide qualitative and quantitative assessment of the M component, respectively. Once the presence of an M component has been confirmed, electrophoresis provides the more practical information for managing patients with monoclonal gammopathies. In a given patient, the amount of M component in the serum is a reliable measure of the tumor burden. This makes the M component an excellent tumor marker, yet it is not specific enough to be used to screen asymptomatic patients. In addition to the plasma cell disorders, M components may be detected in other lymphoid neoplasms such as chronic lymphocytic leukemia and lymphomas of B or T cell origin; nonlymphoid neoplasms such as chronic myeloid leukemia, breast cancer, and colon cancer; a variety of nonneoplastic conditions such as cirrhosis, sarcoidosis, parasitic diseases, Gaucher's disease, and pyoderma gangrenosum; and a number of autoimmune conditions, including rheumatoid arthritis, myasthenia gravis, and cold agglutinin disease. At least two very rare skin diseases—lichen myxedematosus, or papular mucinosis, and necrobiotic xanthogranuloma—are associated with a monoclonal gammopathy. In papular mucinosis, highly cationic IgG is deposited in the dermis of patients. This organ specificity may reflect the specificity of the antibody for some antigenic component of the dermis. Necrobiotic xanthogranuloma is a histiocytic infiltration of the skin, usually of the face, that produces red or yellow nodules that can enlarge to plaques. Some 10% progress to myeloma.

The nature of the M component is variable in plasma cell disorders. It may be an intact antibody molecule of any heavy chain subclass, or it may be an altered antibody or fragment. Isolated light or heavy chains may be produced. In some plasma cell tumors such as extramedullary or solitary bone plasmacytomas, more than a third of patients have an M component. In  $\sim 20\%$  of myelomas, only light chains are produced and in most cases are secreted in the urine as Bence Jones proteins. The frequency of myelomas of a particular heavy chain class is roughly proportional to the serum concentration, and therefore IgG myelomas are more common than IgA and IgD myelomas.



**FIGURE 16-1**

**Representative patterns of serum electrophoresis.** Panel A illustrates the normal pattern of serum protein on electrophoresis. Because there are many different immunoglobulins in the serum, their differing mobilities in an electric field produce a broad peak. In conditions associated with increases in polyclonal immunoglobulin, the broad peak is more prominent (B). In monoclonal gammopathies, the predominance of a product of a single cell produces a “church spire” sharp peak, usually in the  $\gamma$  globulin region (C).

## MULTIPLE MYELOMA

### DEFINITION

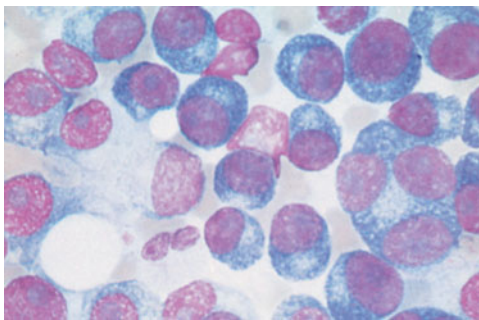
Multiple myeloma represents a malignant proliferation of plasma cells derived from a single clone. The terms *multiple myeloma* and *myeloma* may be used interchangeably. The tumor, its products, and the host response to it

result in a number of organ dysfunctions and symptoms of bone pain or fracture, renal failure, susceptibility to infection, anemia, hypercalcemia, and occasionally clotting abnormalities, neurologic symptoms, and manifestations of hyperviscosity.

## ETIOLOGY

The cause of myeloma is not known. Myeloma occurred with increased frequency in those exposed to the radiation of nuclear warheads in World War II after a 20-year latency. A variety of chromosomal alterations have been found in patients with myeloma; 13q14 deletions, 17p13 deletions, and 11q abnormalities predominate. The most common translocations are  $t(11;14)(q13;q32)$  and  $t(4;14)(p16;q32)$ , and evidence is strong that errors in switch recombination—the genetic mechanism to change antibody heavy chain isotype—participate in the transformation pathway. Overexpression of *myc* or *ras* genes has been noted in some cases. Mutations in p53 and Rb-1 have also been described, but no common molecular pathogenesis has yet emerged.

Myeloma has been seen more commonly than expected among farmers, woodworkers, leather workers, and those exposed to petroleum products. The neoplastic event in myeloma may involve cells earlier in B cell differentiation than the plasma cell. Circulating B cells bearing surface immunoglobulin that share the idiotype of the M component are present in myeloma patients. Interleukin (IL) 6 may play a role in driving myeloma cell proliferation; a large fraction of myeloma cells exposed to IL-6 *in vitro* respond by proliferating. The IL-6 dependency of myeloma is controversial. It remains difficult to distinguish benign from malignant plasma cells on the basis of morphologic criteria in all but a few cases (Fig. 16-2).



**FIGURE 16-2**

**Multiple myeloma (marrow).** The cells bear characteristic morphologic features of plasma cells, round or oval cells with an eccentric nucleus composed of coarsely clumped chromatin, a densely basophilic cytoplasm, and a perinuclear clear zone (hof) containing the Golgi apparatus. Binucleate and multinucleate malignant plasma cells can be seen.

## INCIDENCE AND PREVALENCE



About 19,900 cases of myeloma were diagnosed in 2007, and 10,790 people died from the disease in the United States. Myeloma increases in incidence with age. The median age at diagnosis is 68 years; it is uncommon in people younger than age 40. The yearly incidence is around 4 per 100,000 and remarkably similar throughout the world. Males are more commonly affected than females, and blacks have nearly twice the incidence of whites. Myeloma accounts for ~1% of all malignancies in whites and 2% in blacks; 13% of all hematologic cancers in whites and 33% in blacks.

The incidence of myeloma is highest in African American and Pacific islanders, intermediate in Europeans and North American whites, and lowest in developing countries including Asia. The higher incidence in more developed countries may result from the combination of a longer life expectancy and more frequent medical surveillance. Incidence of multiple myeloma in other ethnic groups including native Hawaiians, female Hispanics, American Indians from New Mexico, and Alaskan natives is higher relative to U.S. whites in the same geographic area. Chinese and Japanese populations have a lower incidence than whites. Immunoproliferative small intestinal disease with alpha heavy chain disease is most prevalent in the Mediterranean area. Despite these differences in prevalence, the characteristics, response to therapy, and prognosis of myeloma are similar worldwide.

## PATHOGENESIS AND CLINICAL MANIFESTATIONS

(Table 16-1) Multiple myeloma (MM) cells bind via cell-surface adhesion molecules to bone marrow stromal cells (BMSCs) and extracellular matrix (ECM), which triggers MM cell growth, survival, drug resistance, and migration in the bone marrow milieu (Fig. 16-3). These effects are due both to direct MM cell–BMSC binding and to induction of various cytokines including IL-6, insulin-like growth factor-1 (IGF-1), vascular endothelial growth factor (VEGF), and stromal cell–derived growth factor (SDF)-1 $\alpha$ . Growth, drug resistance, and migration are mediated via Ras/Raf/mitogen-activated protein kinase, PI3-K/Akt, and protein kinase C signaling cascades, respectively.

Bone pain is the most common symptom in myeloma, affecting nearly 70% of patients. The pain usually involves the back and ribs, and unlike the pain of metastatic carcinoma, which often is worse at night, the pain of myeloma is precipitated by movement. Persistent localized pain in a patient with myeloma usually signifies a pathologic fracture. The bone lesions of myeloma are caused by the proliferation of tumor cells, activation of osteoclasts that destroy bone, and suppression of osteoblasts that form new bone. The osteoclasts respond to osteoclast activating



## CLINICAL FEATURES OF MULTIPLE MYELOMA

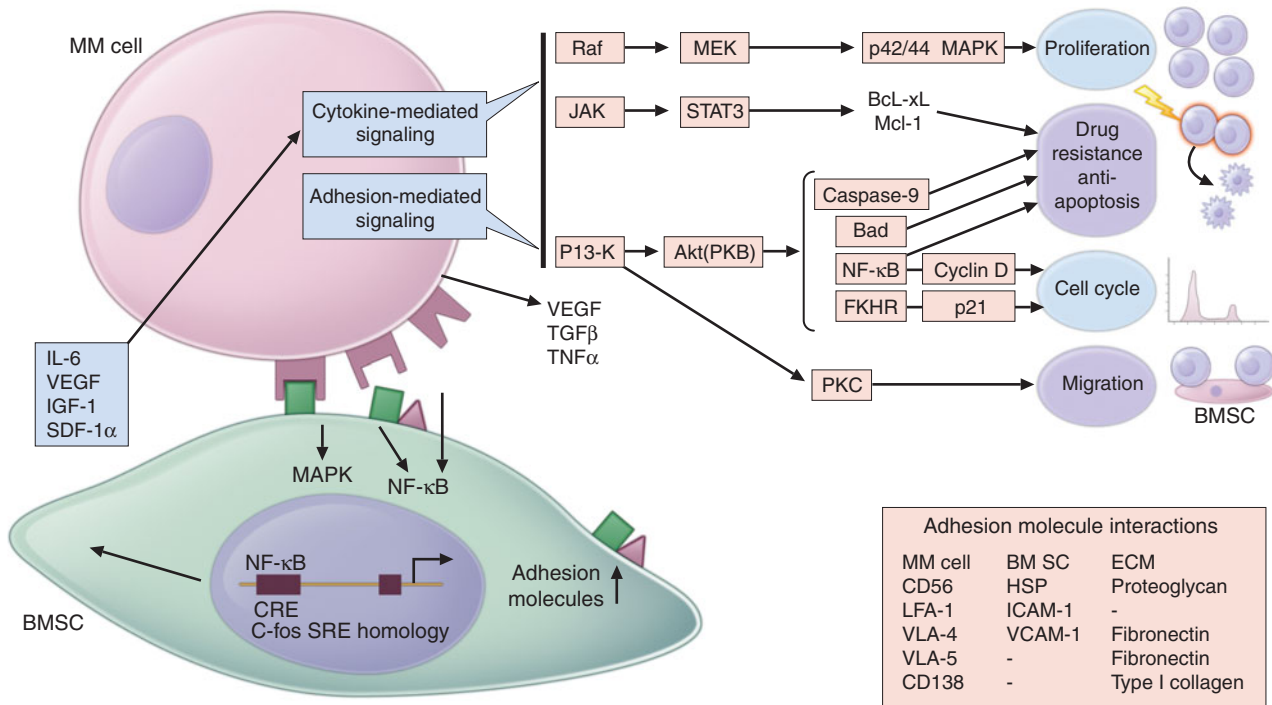
CLINICAL FINDING	UNDERLYING CAUSE AND PATHOGENETIC MECHANISM
Hypercalcemia, osteoporosis, pathologic fractures, lytic bone lesions, bone pain	Tumor expansion, production of osteoclast activating factor by tumor cells, osteoblast inhibitory factors
Renal failure	Hypercalcemia, light chain deposition, amyloidosis, urate nephropathy, drug toxicity (nonsteroidal anti-inflammatory agents, bisphosphonates), contrast dye
Easy fatigue—anemia	Bone marrow infiltration, production of inhibitory factors, hemolysis, decreased red cell production, decreased erythropoietin levels
Recurrent infections	Hypogammaglobulinemia, low CD4 count, decreased neutrophil migration
Neurologic symptoms	Hyperviscosity, cryoglobulinemia, amyloid deposits, hypercalcemia, nerve compression, anti-neuronal antibody, POEMS syndrome, therapy-related toxicity
Nausea and vomiting	Renal failure, hypercalcemia
Bleeding/clotting disorder	Interference with clotting factors, antibody to clotting factors, amyloid damage of endothelium, platelet dysfunction, antibody coating of platelet, therapy-related hypercoagulable defects

**Note:** POEMS, polyneuropathy, organomegaly, endocrinopathy, multiple myeloma, and skin changes.

factors (OAFs) made by the myeloma cells [OAF activity can be mediated by several cytokines, including IL-1, lymphotoxin, VEGF, receptor activator of NF- $\kappa$ B (RANK) ligand, macrophage inhibitory factor (MIP)-1 $\alpha$ , and tumor necrosis factor (TNF)]. However, production of these factors decreases following administration of glucocorticoids or interferon (IFN)  $\alpha$ . The bone lesions are lytic and rarely associated with osteoblastic new bone formation. Therefore radioisotopic bone scanning is less useful in diagnosis than is plain radiography. The bony lysis results in substantial mobilization of calcium from bone, and serious acute and chronic complications of hypercalcemia may dominate the clinical picture (see later). Localized bone lesions may expand to the point that mass lesions may be palpated, especially on the skull (Fig. 16-4), clavicles, and sternum, and the collapse of vertebrae may lead to spinal cord compression.

The next most common clinical problem in patients with myeloma is susceptibility to bacterial infections. The most common infections are pneumonias and pyelonephritis, and the most frequent pathogens are *Streptococcus pneumoniae*, *Staphylococcus aureus*, and *Klebsiella pneumoniae* in the lungs and *Escherichia coli* and other gram-negative organisms in the urinary tract. In ~25% of patients, recurrent infections are the presenting features, and >75% of patients have a serious infection at some time in their course. The susceptibility to infection has several contributing causes. First, patients with myeloma have diffuse hypogammaglobulinemia if the M component is excluded. The hypogammaglobulinemia is related to both decreased production and increased destruction of normal antibodies. Moreover, some patients generate a population of circulating regulatory cells in response to their myeloma that can suppress normal antibody synthesis. In the case of IgG myeloma, normal IgG antibodies are broken down more rapidly than normal because the catabolic rate for IgG antibodies varies directly with the serum concentration. The large M component results in fractional catabolic rates of 8–16% instead of the normal 2%. These patients have very poor antibody responses, especially to polysaccharide antigens such as those on bacterial cell walls. Most measures of T cell function in myeloma are normal, but a subset of CD4+ cells may be decreased. Granulocyte lysozyme content is low, and granulocyte migration is not as rapid as normal in patients with myeloma, probably the result of a tumor product. There are also a variety of abnormalities in complement functions in myeloma patients. All these factors contribute to the immune deficiency of these patients. Some commonly used therapeutic agents, e.g., dexamethasone, suppress immune responses and increase susceptibility to infection.

Renal failure occurs in nearly 25% of myeloma patients, and some renal pathology is noted in over half. Many factors contribute to this. Hypercalcemia is the most common cause of renal failure. Glomerular deposits of amyloid, hyperuricemia, recurrent infections, frequent use of nonsteroidal anti-inflammatory agents for pain control, use of iodinated contrast dye for imaging, bisphosphonate use, and occasional infiltration of the kidney by myeloma cells all may contribute to renal dysfunction. However, tubular damage associated with the excretion of light chains is almost always present. Normally, light chains are filtered, reabsorbed in the tubules, and catabolized. With the increase in the amount of light chains presented to the tubule, the tubular cells become overloaded with these proteins, and tubular damage results either directly from light chain toxic effects or indirectly from the release of intracellular lysosomal enzymes. The earliest manifestation of this tubular damage is the adult Fanconi's syndrome (a type 2 proximal renal tubular acidosis), with loss of glucose and amino acids, as well as defects in the ability of the

**FIGURE 16-3**

**Pathogenesis of multiple myeloma.** Multiple myeloma cells interact with bone marrow stromal cells and extracellular matrix proteins via adhesion molecules, triggering adhesion-mediated signaling as well as cytokine production. This triggers

cytokine-mediated signaling that provides growth, survival, and anti-apoptotic effects as well as development of drug resistance. HSP, heparin sulfate proteoglycan.

kidney to acidify and concentrate the urine. The proteinuria is not accompanied by hypertension, and the protein is nearly all light chains. Generally, very little albumin is in the urine because glomerular function is

**FIGURE 16-4**

**Bony lesions in multiple myeloma.** The skull demonstrates the typical “punched-out” lesions characteristic of multiple myeloma. The lesion represents a purely osteolytic lesion with little or no osteoblastic activity. (Courtesy of Dr. Geraldine Schechter; with permission.)

usually normal. When the glomeruli are involved, nonselective proteinuria is also observed. Patients with myeloma also have a decreased anion gap [i.e.,  $\text{Na}^+ - (\text{Cl}^- + \text{HCO}_3^-)$ ] because the M component is cationic, resulting in retention of chloride. This is often accompanied by hyponatremia that is felt to be artificial (pseudohyponatremia) because each volume of serum has less water as a result of the increased protein. Renal dysfunction due to light chain deposition disease, light chain cast nephropathy, and amyloidosis is partially reversible with effective therapy. Myeloma patients are susceptible to developing acute renal failure if they become dehydrated.

Anemia occurs in ~80% of myeloma patients. It is usually normocytic and normochromic and related both to the replacement of normal marrow by expanding tumor cells and to the inhibition of hematopoiesis by factors made by the tumor. In addition, mild hemolysis may contribute to the anemia. A larger than expected fraction of patients may have megaloblastic anemia due to either folate or vitamin B<sub>12</sub> deficiency. Granulocytopenia and thrombocytopenia are very rare. Clotting abnormalities may be seen due to the failure of antibody-coated platelets to function properly or to the interaction of the M component with clotting factors I, II, V, VII, or VIII. Deep vein thrombosis is also observed with use of thalidomide or lenalidomide in combination

with dexamethasone. Raynaud's phenomenon and impaired circulation may result if the M component forms cryoglobulins, and hyperviscosity syndromes may develop depending on the physical properties of the M component (most common with IgM, IgG3, and IgA paraproteins). Hyperviscosity is defined on the basis of the relative viscosity of serum as compared with water. Normal relative serum viscosity is 1.8 (i.e., serum is normally almost twice as viscous as water). Symptoms of hyperviscosity occur at a level of 5–6, a level usually reached at paraprotein concentrations of ~40 g/L (4 g/dL) for IgM, 50 g/L (5 g/dL) for IgG3, and 70 g/L (7 g/dL) for IgA.

Although neurologic symptoms occur in a minority of patients, they may have many causes. Hypercalcemia may produce lethargy, weakness, depression, and confusion. Hyperviscosity may lead to headache, fatigue, visual disturbances, and retinopathy. Bony damage and collapse may lead to cord compression, radicular pain, and loss of bowel and bladder control. Infiltration of peripheral nerves by amyloid can be a cause of carpal tunnel syndrome and other sensorimotor mono- and polyneuropathies. Sensory neuropathy is also a side effect of thalidomide and bortezomib therapy.

Many of the clinical features of myeloma, e.g., cord compression, pathologic fractures, hyperviscosity, sepsis, and hypercalcemia, can present as medical emergencies. Despite the widespread distribution of plasma cells in the body, tumor expansion is dominantly within bone and bone marrow and, for reasons unknown, rarely causes enlargement of spleen, lymph nodes, or gut-associated lymphatic tissue.

## DIAGNOSIS AND STAGING

The classic triad of myeloma is marrow plasmacytosis (>10%), lytic bone lesions, and a serum and/or urine M component. Bone marrow plasma cells are CD138+ and monoclonal. The most important differential diagnosis in patients with myeloma involves their separation from individuals with monoclonal gammopathies of uncertain significance (MGUS). MGUS are vastly more common than myeloma, occurring in 1% of the population >50 years of age and in up to 10% individuals >75 years. The diagnostic criteria for MGUS, smoldering myeloma, and myeloma are described in [Table 16-2](#). When bone marrow cells are exposed to radioactive thymidine to quantitate dividing cells, patients with MGUS always have a labeling index <1%; patients with myeloma always have a labeling index >1%. With long-term follow-up, ~1% per year of patients with MGUS go on to develop myeloma. Non-IgG subtype, abnormal kappa/lambda free light chain ratio, and serum M protein >15 g/L (1.5 g/dL) are associated with higher incidence of progression of MGUS to myeloma. Typically, patients with MGUS require no therapy. Their survival is ~2 years shorter than age-matched controls without MGUS. There are

**TABLE 16-2**

### DIAGNOSTIC CRITERIA FOR MULTIPLE MYELOMA, MYELOMA VARIANTS, AND MONOCLONAL GAMMOPATHY OF UNKNOWN SIGNIFICANCE

#### Monoclonal gammopathy of undetermined significance (MGUS)

- M protein in serum <30 g/L
- Bone marrow clonal plasma cells <10%
- No evidence of other B cell proliferative disorders
- No myeloma-related organ or tissue impairment (no end organ damage, including bone lesions)<sup>a</sup>

#### Asymptomatic myeloma (smoldering myeloma)

- M protein in serum ≥30 g/L and/or
- Bone marrow clonal plasma cells ≥10%
- No myeloma-related organ or tissue impairment (no end organ damage, including bone lesions)<sup>a</sup> or symptoms

#### Symptomatic multiple myeloma

- M protein in serum and/or urine
- Bone marrow (clonal) plasma cells<sup>b</sup> or plasmacytoma
- Myeloma-related organ or tissue impairment (end organ damage, including bone lesions)

#### Nonsecretory myeloma

- No M protein in serum and/or urine with immunofixation
- Bone marrow clonal plasmacytosis ≥10% or plasmacytoma
- Myeloma-related organ or tissue impairment (end organ damage, including bone lesions)<sup>a</sup>

#### Solitary plasmacytoma of bone

- No M protein in serum and/or urine<sup>c</sup>
- Single area of bone destruction due to clonal plasma cells
- Bone marrow not consistent with multiple myeloma
- Normal skeletal survey (and MRI of spine and pelvis if done)
- No related organ or tissue impairment (no end organ damage other than solitary bone lesion)<sup>a</sup>

<sup>a</sup>Myeloma-related organ or tissue impairment (end organ damage) (ROTI): Calcium levels increased: serum calcium >0.25 mmol/L above the upper limit of normal or >2.75 mmol/L; renal insufficiency: creatinine >173 mmol/L; anemia: hemoglobin 2 g/dL below the lower limit of normal or hemoglobin <10 g/dL; bone lesions: lytic lesions or osteoporosis with compression fractures (MRI or CT may clarify); other: symptomatic hyperviscosity, amyloidosis, recurrent bacterial infections (>2 episodes in 12 months).

<sup>b</sup>If flow cytometry is performed, most plasma cells (>90%) show a "neoplastic" phenotype.

<sup>c</sup>A small M component may sometimes be present.

two important variants of myeloma: solitary bone plasmacytoma and extramedullary plasmacytoma. These lesions are associated with an M component in <30% of the cases, they may affect younger individuals, and both are associated with median survivals of ≥10 years. Solitary bone plasmacytoma is a single lytic bone lesion without marrow plasmacytosis. Extramedullary plasmacytomas usually involve the submucosal lymphoid tissue of the nasopharynx or paranasal sinuses without marrow plasmacytosis. Both tumors are highly responsive to local

radiation therapy. If an M component is present, it should disappear after treatment. Solitary bone plasmacytomas may recur in other bony sites or evolve into myeloma. Extramedullary plasmacytomas rarely recur or progress.

The clinical evaluation of patients with myeloma includes a careful physical examination searching for tender bones and masses. Only a small minority of patients has an enlargement of the spleen and lymph nodes, the physiologic sites of antibody production. Chest and bone radiographs may reveal lytic lesions or diffuse osteopenia. MRI offers a sensitive means to document extent of bone marrow infiltration and cord or root compression in patients with pain syndromes. A complete blood count with differential may reveal anemia. Erythrocyte sedimentation rate is elevated. Rare patients (~2%) may have plasma cell leukemia with >2000 plasma cells/ $\mu$ L. This may be seen in disproportionate frequency in IgD (12%) and IgE (25%) myelomas. Serum calcium, urea nitrogen, creatinine, and uric acid levels may be elevated. Protein electrophoresis and measurement of serum immunoglobulins and free light chains are useful for detecting and characterizing M spikes, supplemented by immunoelectrophoresis, which is especially sensitive for identifying low concentrations of M components not detectable by protein electrophoresis. A 24-h urine specimen is necessary to quantitate protein excretion, and a concentrated aliquot is used for electrophoresis and immunologic typing of any M component. Serum alkaline phosphatase is usually normal even with extensive bone involvement because of the absence of osteoblastic activity. It is also important to quantitate serum  $\beta_2$ -microglobulin (see later). Serum soluble IL-6 receptor levels and C-reactive protein may reflect physiologic IL-6 levels in the patient.

The serum M component will be IgG in 53% of patients, IgA in 25%, and IgD in 1%; 20% of patients have only light chains in serum and urine. Dipsticks for detecting proteinuria are not reliable at identifying light chains, and the heat test for detecting Bence Jones protein is falsely negative in ~50% of patients with light chain myeloma. Fewer than 1% of patients have no identifiable M component; these patients usually have light chain myeloma in which renal catabolism has made the light chains undetectable in the urine. IgD myeloma may also present as light chain myeloma. About two-thirds of patients with serum M components also have urinary light chains. The light chain isotype may have an impact on survival. Patients secreting lambda light chains have a significantly shorter overall survival than those secreting kappa light chains. It is not clear whether this is due to some genetically important determinant of cell proliferation or because lambda light chains are more likely to cause renal damage and form amyloid than are kappa light chains. The heavy chain isotype may have an impact on

patient management as well. About half of patients with IgM paraproteins develop hyperviscosity compared with only 2–4% of patients with IgA and IgG M components. Among IgG myelomas, it is the IgG3 subclass that has the highest tendency to form both concentration- and temperature-dependent aggregates, leading to hyperviscosity and cold agglutination at lower serum concentrations.

The various staging systems for patients with myeloma (Table 16-3) are functional systems for predicting survival and are based on a variety of clinical and laboratory tests, unlike the anatomic staging systems for solid tumors. The Durie-Salmon staging system is based on the hemoglobin, calcium, M component, and degree of skeletal involvement; the total-body tumor burden is estimated to be low (stage I), intermediate (stage II), or high (stage III), and the stages are further subdivided on the basis of renal function [A if serum creatinine <177 mol/L (<2 mg/dL), B if >177 (>2)]. Patients in stage IA have a median survival of >5 years and those in stage IIIB ~15 months. This staging system has been found not to predict prognosis after treatment with high-dose therapy or the novel targeted therapies that have emerged.

Serum  $\beta_2$ -microglobulin is a protein of 11,000 mol wt with homologies with the constant region of immunoglobulins that is the light chain of the class I major histocompatibility antigens (HLA-A, -B, -C) on the surface of every cell. Serum  $\beta_2$ -microglobulin is the single most powerful predictor of survival and can substitute for staging. Patients with  $\beta_2$ -microglobulin levels <0.004 g/L have a median survival of 43 months and those with levels >0.004 g/L only 12 months. Serum  $\beta_2$ -microglobulin and albumin levels are the basis for a three-stage International Staging System (ISS). It is also believed that once the diagnosis of myeloma is firm, histologic features of atypia may also exert an influence on prognosis. IL-6 may be an autocrine and/or paracrine growth factor for myeloma cells; elevated levels are associated with more aggressive disease. High labeling index and high levels of lactate dehydrogenase are also associated with poor prognosis.

Other factors that may influence prognosis are the number of cytogenetic abnormalities including hyperploidy, chromosome 13q and 17p deletion, t(4;14) and t(11;14); % plasma cells in the marrow; circulating plasma cells; performance status; as well as serum levels of soluble IL-6 receptor, C-reactive protein, hepatocyte growth factor, C-terminal cross-linked telopeptide of collagen I, transforming growth factor (TGF)  $\beta$ , and syndecan-1. Microarray profiling and comparative genomic hybridization have formed the basis for RNA- and DNA-based prognostic staging systems, respectively. The ISS system is the most widely used method of assessing prognosis (Table 16-3).

TABLE 16-3

## MYELOMA STAGING SYSTEMS

## DURIE-SALMON STAGING SYSTEM

Stage	Criteria	Estimated Tumor Burden, $\times 10^{12}$ cells/m <sup>2</sup>
I	All of the following: 1. Hemoglobin >100 g/L (>10 g/dL) 2. Serum calcium <3 mmol/L (<12 mg/dL) 3. Normal bone x-ray or solitary lesion 4. Low M-component production a. IgG level <50 g/L (<5 g/dL) b. IgA level <30 g/L (<3 g/dL) c. Urine light chain <4 g/24 h	<0.6 (low)
II	Fitting neither I nor III	0.6–1.20 (intermediate)
III	One or more of the following: 1. Hemoglobin <85 g/L (<8.5 g/dL) 2. Serum calcium >3 mmol/L (>12 mg/dL) 3. Advanced lytic bone lesions 4. High M-component production a. IgG level >70 g/L (>7 g/dL) b. IgA level >50 g/L (>5 g/dL) c. Urine light chains >12 g/24 h	>1.20 (high)
Level	Stage	Median Survival, Months
<b>Subclassification Based on Serum Creatinine Levels</b>		
A < 177 $\mu$ mol/L (<2 mg/dL)	IA	61
B >177 $\mu$ mol/L (>2 mg/dL)	IIA, B	55
	IIIA	30
	IIIB	15
<b>International Staging System</b>		
$\beta_2$ M < 3.5, alb $\geq$ 3.5	I (28%)	62
$\beta_2$ M < 3.5, alb < 3.5 or $\beta_2$ M = 3.5–5.5	II (39%)	44
$\beta_2$ M >5.5	III (33%)	29

**Note:**  $\beta_2$ M, serum  $\beta_2$ -microglobulin in mg/L; alb, serum albumin in g/dL; (#), % patients presenting at each stage.

### Rx Treatment: MULTIPLE MYELOMA

About 10% of patients with myeloma have an indolent course demonstrating only very slow progression of disease over many years. Such patients only require anti-tumor therapy when the disease becomes symptomatic with development of anemia, hypercalcemia, progressive lytic bone lesions (including vertebral compression fractures), progressive rise in serum myeloma protein levels and/or Bence Jones proteinuria, or recurrent infections. Patients with solitary bone plasmacytomas and extramedullary plasmacytomas may be expected to enjoy prolonged disease-free survival after local radiation therapy to a dose of ~40 Gy. There is a low incidence of

occult marrow involvement in patients with solitary bone plasmacytoma. Such patients are usually detected because their serum M component falls slowly or disappears initially only to return after a few months. These patients respond well to systemic chemotherapy.

Patients with symptomatic and/or progressive myeloma require therapeutic intervention. In general such therapy is of two sorts: systemic therapy to control the progression of myeloma, and symptomatic supportive care to prevent serious morbidity from the complications of the disease. Therapy can significantly prolong survival and improve the quality of life for myeloma patients.

The initial standard treatment for newly diagnosed myeloma depends on whether or not the patient is a

candidate for high-dose chemotherapy with autologous stem cell transplant.

In patients who are transplant candidates, alkylating agents such as melphalan should be avoided because they damage stem cells, leading to decreased ability to collect stem cells for autologous transplant. High-dose pulsed glucocorticoids have been used either alone (dexamethasone, 40 mg for 4 days every 2 weeks) or in combination VAD chemotherapy (vincristine, 0.4 mg/d in a 4-day continuous infusion; doxorubicin, 9 mg/m<sup>2</sup> per day in a 4-day continuous infusion; dexamethasone, 40 mg/d for 4 days per week for 3 weeks) for initial cytoreduction. However, two studies have combined thalidomide with dexamethasone as initial therapy for newly diagnosed multiple myeloma in transplant candidates and reported rapid responses in two-thirds of patients while allowing for successful harvesting of peripheral blood stem cells for transplantation. A randomized phase III trial showed statistically significantly higher response rates for thalidomide (200 mg PO qhs) plus dexamethasone (40 mg for 4 days every 2 weeks) compared to dexamethasone alone, setting the stage for use of this combination as standard therapy in newly diagnosed patients. Initial therapy is continued until maximal cytoreduction. Importantly, novel agents bortezomib, a proteasome inhibitor, and lenalidomide, an immunomodulatory derivative of thalidomide, have similarly been combined with dexamethasone and obtained high response rates without compromising collection of stem cells for transplantation.

In patients who are not transplant candidates, therapy has consisted of intermittent pulses of an alkylating agent, L-phenylalanine mustard (L-PAM, melphalan) and prednisone administered for 4–7 days every 4–6 weeks. The usual doses of melphalan/prednisone (MP) are melphalan, 8 mg/m<sup>2</sup> per day, and prednisone, 25–60 mg/m<sup>2</sup> per day for 4 days. Doses may need adjustment due to unpredictable absorption and based on marrow tolerance. Patients responding to therapy generally have a prompt and gratifying reduction in bone pain, hypercalcemia, and anemia, and often have fewer infections. The serum M component lags substantially behind the symptomatic improvement, often taking 4–6 weeks to fall. This fall depends on the rate of tumor kill and the fractional catabolic rate of immunoglobulin, which in turn depends on the serum concentration (for IgG). Light chain excretion, with a functional half-life of ~6 h, may fall within the first week of treatment. However, because urine light chain levels may relate to renal tubular function, they are not a reliable measure of tumor cell kill. Calculations of tumor cell kill are made by extrapolation of the serum M component level and rely heavily on the assumption that every tumor cell produces immunoglobulin at a constant rate. About 60% of patients achieve at least a 75% reduction in serum M component level and tumor cell mass in

response to melphalan and prednisone. Although this is a tumor reduction of <1 log, clinical responses may last many months. The important feature of the level of the M protein is not how far or how fast it falls, but the rate of its increase after therapy. Efforts to improve the fraction of patients responding and the degree of response have involved adding other active agents to the treatment program. In patients >65 years of age, combining thalidomide with MP (MPT) obtains higher response rates and overall survival than MP alone, and MPT is the standard therapy for patients who are not transplant candidates.

Randomized studies comparing standard-dose therapy to high-dose melphalan therapy (HDT) with hematopoietic stem cell support have shown that HDT can achieve high overall response rates and prolonged progression-free and overall survival; however, few, if any, patients are cured. Although complete responses are rare (<5%) with standard-dose chemotherapy, HDT achieves 25–40% complete responses. In randomized studies, HDT produced better median event-free survival in four of five studies, higher complete response rate in four of five trials, and better overall survival in three of five studies. Two successive HDTs (tandem transplants) are more effective than single HDT in the subset of patients who do not achieve a complete or very good partial response to the first transplant. Allogeneic transplants may also produce high response rates, but treatment-related mortality may be as high as 40%. Nonmyeloablative allogeneic transplantation is now under evaluation to reduce toxicity while permitting an immune graft-versus-myeloma effect.

There is no standard maintenance therapy to prolong time to progression. IFN- $\gamma$  has allowed modest benefit but has significant side effects. Oral prednisone maintenance therapy was effective in a single trial. Ongoing studies are evaluating maintenance thalidomide and lenalidomide to prolong progression-free survival posttransplant.

Relapsed myeloma can be treated with novel agents including lenalidomide and/or bortezomib. These agents target not only the tumor cell but also the tumor cell–bone marrow interaction and the bone marrow milieu. These agents in combination with dexamethasone can achieve up to 60% partial responses and 10–15% complete responses in patients with relapsed disease. The combination of bortezomib and liposomal doxorubicin is active in relapsed myeloma. Thalidomide, if not used as initial therapy, can achieve responses in refractory cases. High-dose melphalan and stem cell transplant, if not used earlier, also have activity in patients with refractory disease.

The median overall survival of patients with myeloma is 5–6 years, with subsets of patients surviving >10 years. The major causes of death are progressive myeloma, renal failure, sepsis, or therapy-related acute

leukemia or myelodysplasia. Nearly a quarter of patients die of myocardial infarction, chronic lung disease, diabetes, or stroke, all intercurrent illnesses related more to the age of the patient group than to the tumor.

Supportive care directed at the anticipated complications of the disease may be as important as primary antitumor therapy. The hypercalcemia generally responds well to bisphosphonates, glucocorticoid therapy, hydration, and natriuresis. Calcitonin may add to the inhibitory effects of glucocorticoids on bone resorption. Bisphosphonates (e.g., pamidronate, 90 mg, or zoledronate, 4 mg once a month) reduce osteoclastic bone resorption and preserve performance status and quality of life, decrease bone-related complications, and may also have antitumor effects. Treatments aimed at strengthening the skeleton, such as fluorides, calcium, and vitamin D, with or without androgens, have been suggested but are not of proven efficacy. Iatrogenic worsening of renal function may be prevented by maintaining a high fluid intake to prevent dehydration and to help excrete light chains and calcium. In the event of acute renal failure, plasmapheresis is ~10 times more effective at clearing light chains than peritoneal dialysis; however, its role in reversing renal failure remains controversial. Importantly, reducing the protein load by effective antitumor therapy with agents such as bortezomib may result in functional improvement. Urinary tract infections should be watched for and treated early. Plasmapheresis may be the treatment of choice for hyperviscosity syndromes. Although the pneumococcus is a dreaded pathogen in myeloma patients, pneumococcal polysaccharide vaccines may not elicit an antibody response. Prophylactic administration of IV  $\gamma$  globulin preparations is used in the setting of recurrent serious infections. Chronic oral antibiotic prophylaxis is probably not warranted. Patients developing neurologic symptoms in the lower extremities, severe localized back pain, or problems with bowel and bladder control may need emergency MRI and radiation therapy for palliation. Most bone lesions respond to analgesics and chemotherapy, but certain painful lesions may respond most promptly to localized radiation. The anemia associated with myeloma may respond to erythropoietin along with hematinics (iron, folate, cobalamin). The pathogenesis of the anemia should be established and specific therapy instituted, where possible.

### WALDENSTRÖM'S MACROGLOBULINEMIA

In 1948, Waldenström described a malignancy of lymphoplasmacytoid cells that secreted IgM. In contrast to myeloma, the disease was associated with lymphadenopathy and hepatosplenomegaly, but the major

clinical manifestation was the hyperviscosity syndrome. The disease resembles the related diseases chronic lymphocytic leukemia, myeloma, and lymphocytic lymphoma. It originates from a post-germinal center B cell that has undergone somatic mutations and antigenic selection in the lymphoid follicle and has the characteristics of an IgM-bearing memory B cell. Waldenström's macroglobulinemia and IgM myeloma follow a similar clinical course, but therapeutic options are different. The diagnosis of IgM myeloma is usually reserved for patients with lytic bone lesions and predominant infiltration with CD138+ plasma cells in the bone marrow. Such patients are at greater risk of pathologic fractures than patients with Waldenström's macroglobulinemia.

The cause of macroglobulinemia is unknown. The disease is similar to myeloma in being slightly more common in men and occurring with increased incidence with age (median: 64 years). There have been reports that the IgM in some patients with macroglobulinemia may have specificity for myelin-associated glycoprotein (MAG), a protein that has been associated with demyelinating disease of the peripheral nervous system and may be lost earlier and to a greater extent than the better known myelin basic protein in patients with multiple sclerosis. Sometimes patients with macroglobulinemia develop a peripheral neuropathy before the appearance of the neoplasm. There is speculation that the whole process begins with a viral infection that may elicit an antibody response that cross-reacts with a normal tissue component.

Like myeloma, the disease involves the bone marrow, but unlike myeloma, it does not cause bone lesions or hypercalcemia. Like myeloma, a serum M component is present in the serum in excess of 30 g/L (3 g/dL), but unlike myeloma, the size of the IgM paraprotein results in little renal excretion, and only ~20% of patients excrete light chains. Therefore, renal disease is not common. The light chain isotype is kappa in 80% of the cases. Patients present with weakness, fatigue, and recurrent infections, similar to myeloma patients, but epistaxis, visual disturbances, and neurologic symptoms such as peripheral neuropathy, dizziness, headache, and transient paresis are much more common in macroglobulinemia. Physical examination reveals adenopathy and hepatosplenomegaly, and ophthalmoscopic examination may reveal vascular segmentation and dilatation of the retinal veins characteristic of hyperviscosity states. Patients may have a normocytic, normochromic anemia, but rouleaux formation and a positive Coombs test are much more common than in myeloma. Malignant lymphocytes are usually present in the peripheral blood. About 10% of macroglobulins are cryoglobulins. These are pure M components and are not the mixed cryoglobulins seen in rheumatoid arthritis and other autoimmune diseases. Mixed cryoglobulins are composed of IgM or IgA complexed with IgG, for which they are specific. In both cases, Raynaud's phenomenon

and serious vascular symptoms precipitated by the cold may occur, but mixed cryoglobulins are not commonly associated with malignancy. Patients suspected of having a cryoglobulin based on history and physical examination should have their blood drawn into a warm syringe and delivered to the laboratory in a container of warm water to avoid errors in quantitating the cryoglobulin.

### **Rx Treatment:** **WALDENSTRÖM'S** **MACROGLOBULINEMIA**

Control of serious hyperviscosity symptoms such as an altered state of consciousness or paresis can be achieved acutely by plasmapheresis because 80% of the IgM paraprotein is intravascular. The median survival is ~50 months, similar to that of multiple myeloma. However, many individuals with Waldenström's macroglobulinemia have indolent disease that does not require therapy. Pretreatment parameters including older age, male sex, general symptoms, and cytopenias define a high-risk population. Fludarabine (25 mg/m<sup>2</sup> per day for 5 days every 4 weeks) or cladribine (0.1 mg/kg per day for 7 days every 4 weeks) are highly effective single agents. About 80% of patients respond to chemotherapy, and their median survival is >3 years. Rituximab (anti-CD20) can produce responses alone or combined with chemotherapy. As in multiple myeloma, bortezomib and lenalidomide also have activity.

### **POEMS SYNDROME**

The features of this syndrome are *poly*neuropathy, *organomegaly*, *endocrinopathy*, *multiple* myeloma, and *skin changes* (POEMS). Patients usually have a severe, progressive sensorimotor polyneuropathy associated with sclerotic bone lesions from myeloma. Polyneuropathy occurs in ~1.4% of myelomas, but the POEMS syndrome is only a rare subset of that group. Unlike typical myeloma, hepatomegaly and lymphadenopathy occur in about two-thirds of patients, and splenomegaly is seen in one-third. The lymphadenopathy frequently resembles Castleman's disease histologically, a condition that has been linked to IL-6 overproduction. The endocrine manifestations include amenorrhea in women and impotence and gynecomastia in men. Hyperprolactinemia due to loss of normal inhibitory control by the hypothalamus may be associated with other central nervous system manifestations such as papilledema and elevated cerebrospinal fluid pressure and protein. Type 2 diabetes mellitus occurs in about a third of patients. Hypothyroidism and adrenal insufficiency are occasionally noted. Skin changes are diverse: hyperpigmentation, hypertrichosis, skin thickening, and digital clubbing. Other manifestations include

peripheral edema, ascites, pleural effusions, fever, and thrombocytosis.

The pathogenesis of the disease is unclear, but high circulating levels of the proinflammatory cytokines IL-1, IL-6, VEGF, and TNF have been documented, and levels of the inhibitory cytokine TGF- $\beta$  are lower than expected. Treatment of the myeloma may result in an improvement in the other disease manifestations.

Patients are often treated similarly to those with myeloma. Plasmapheresis does not appear to be of benefit in POEMS syndrome. Patients presenting with isolated sclerotic lesions may have resolution of neuropathic symptoms after local therapy for plasmacytoma with radiotherapy. Similar to multiple myeloma, novel agents as well as high-dose therapy with autologous stem cell transplant have been pursued in selected patients and have been associated with prolonged progression-free survival.

### **HEAVY CHAIN DISEASES**

The heavy chain diseases are rare lymphoplasmacytic malignancies. Their clinical manifestations vary with the heavy chain isotype. Patients secrete a defective heavy chain that usually has an intact Fc fragment and a deletion in the Fd region. Gamma, alpha, and mu heavy chain diseases have been described, but no reports of delta or epsilon heavy chain diseases have appeared. Molecular biologic analysis of these tumors has revealed structural genetic defects that may account for the aberrant chain secreted.

#### **GAMMA HEAVY CHAIN DISEASE** **(FRANKLIN'S DISEASE)**

This disease affects individuals of widely different age groups and countries of origin. It is characterized by lymphadenopathy, fever, anemia, malaise, hepatosplenomegaly, and weakness. Its most distinctive symptom is palatal edema, resulting from involvement of nodes in Waldeyer's ring, and this may progress to produce respiratory compromise. The diagnosis depends on the demonstration of an anomalous serum M component [often <20 g/L (<2 g/dL)] that reacts with anti-IgG but not anti-light chain reagents. *The M component is typically present in both serum and urine.* Most of the paraproteins have been of the gamma<sub>1</sub> subclass, but other subclasses have been seen. The patients may have thrombocytopenia, eosinophilia, and nondiagnostic bone marrow. Patients usually have a rapid downhill course and die of infection; however, some patients have survived 5 years with chemotherapy.

#### **ALPHA HEAVY CHAIN DISEASE** **(SELIGMANN'S DISEASE)**

This is the most common of the heavy chain diseases. It is closely related to a malignancy known as *Mediterranean*



216 *lymphoma*, a disease that affects young persons in parts of the world where intestinal parasites are common, such as the Mediterranean, Asia, and South America. The disease is characterized by an infiltration of the lamina propria of the small intestine with lymphoplasmacytoid cells that secrete truncated alpha chains. Demonstrating alpha heavy chains is difficult because the alpha chains tend to polymerize and appear as a smear instead of a sharp peak on electrophoretic profiles. Despite the polymerization, hyperviscosity is not a common problem in alpha heavy chain disease. Without J chain–facilitated dimerization, viscosity does not increase dramatically. Light chains are absent from serum and urine. The patients present with chronic diarrhea, weight loss, and malabsorption and have extensive mesenteric and paraaortic adenopathy. Respiratory tract involvement occurs rarely. Patients may vary widely in their clinical course. Some may develop diffuse aggressive histologies of malignant lymphoma. Chemotherapy may produce long-term remissions. Rare patients appear to have responded to antibiotic therapy, raising the question of the etiologic role of antigenic stimulation, perhaps by some chronic intestinal infection. Chemotherapy plus antibiotics may be more effective than chemotherapy alone. Immunoproliferative small intestinal disease (IPSID) is recognized as an infectious pathogen–associated human lymphoma that has association with *Campylobacter jejuni*. It involves mainly the proximal small intestine resulting in malabsorption, diarrhea, and abdominal pain. IPSID is associated with excessive plasma cell differentiation and produces truncated alpha heavy chain proteins lacking the light chains as well as the first constant domain. Early-stage IPSID responds to antibiotics (30–70% complete remission). Most untreated IPSID patients progress to lymphoplasmacytic and immunoblastic lymphoma.

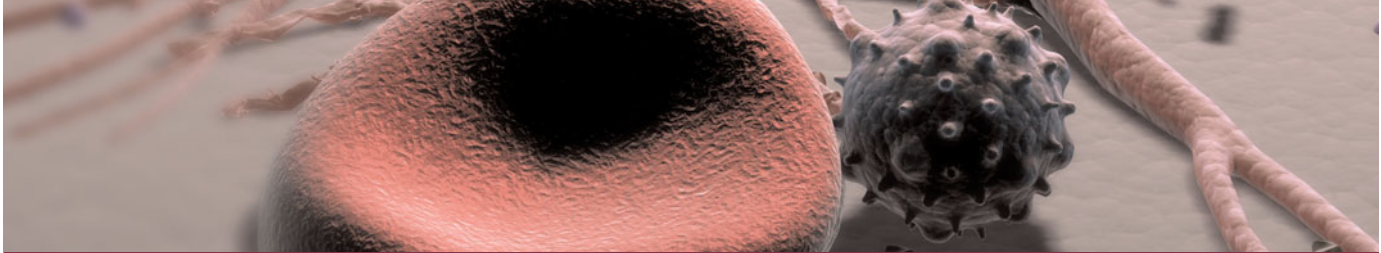
## MU HEAVY CHAIN DISEASE

The secretion of isolated mu heavy chains into the serum appears to occur in a very rare subset of patients with chronic lymphocytic leukemia. The only features that may distinguish patients with mu heavy chain disease are the presence of vacuoles in the malignant lymphocytes and the excretion of kappa light chains in the

urine. The diagnosis requires ultracentrifugation or gel filtration to confirm the nonreactivity of the paraprotein with the light chain reagents because some intact macroglobulins fail to interact with these serums. The tumor cells seem to have a defect in the assembly of light and heavy chains because they appear to contain both in their cytoplasm. There is no evidence that such patients should be treated differently from other patients with chronic lymphocytic leukemia (Chap. 15).

## FURTHER READINGS

- GHOBRIAL IM et al: Waldenström macroglobulinaemia. *Lancet Oncol* 4:679, 2003
- HAROUSSEAU JL, MOREAU P: Evolving role of stem cell transplantation in multiple myeloma. *Clin Lymphoma Myeloma* 6:89, 2005
- : Autologous hematopoietic stem-cell transplantation for multiple myeloma. *N Engl J Med* 360:2645, 2009
- HIDESHIMA T et al: Understanding multiple myeloma pathogenesis in the bone marrow to identify new therapeutic targets. *Nature Rev Cancer* 7:585, 2007
- THE INTERNATIONAL MYELOMA WORKING GROUP: Criteria for the classification of monoclonal gammopathies, multiple myeloma and related disorders: A report of the International Myeloma Working Group. *Br J Haematol* 121:749, 2003
- KUEHL WM, BERGSAGEL PL: Multiple myeloma: Evolving genetic events and host interactions. *Nature Rev Cancer* 2:175, 2002
- KYLE RA, RAJKUMAR SV: Multiple myeloma. *N Engl J Med* 351:1860, 2004
- KYLE RA, THERNEAU TM, et al: Prevalence of monoclonal gammopathy of undetermined significance. *N Engl J Med* 354:1362, 2006
- KYLE RA, YEE GC, et al: American Society of Clinical Oncology 2007 clinical practice guideline update on the role of bisphosphonates in multiple myeloma. *J Clin Oncol* 25:2464, 2007
- LAUBACH J et al: Maximizing the clinical benefit of novel therapy in multiple myeloma. *Oncology* 23:415, 2009
- MITSIADES CS et al: Focus on multiple myeloma. *Cancer Cell* 6:439, 2005
- MUNSHI NC, ANDERSON KC: Plasma cell neoplasm, in *Principles and Practice of Oncology*, 7th ed, V DeVita, S Rosenberg, S Hellman (eds). Philadelphia, Lippincott–Raven, 2005
- RAAB MS et al: Multiple myeloma. *Lancet* 374:324, 2009
- TREON SP: How I treat Waldenström's macroglobulinemia. *Blood* 114:2375, 2009
- TREON SP et al: Update on treatment recommendations from the Third International Workshop on Waldenström's macroglobulinemia. *Blood* 107:3442, 2006
- WAHNER-ROEDLER DL et al: Gamma-heavy chain disease: Review of 23 cases. *Medicine* 82:236, 2003



## CHAPTER 17

# AMYLOIDOSIS

David C. Seldin ■ Martha Skinner

■ General Principles	217
■ AL Amyloidosis	219
Etiology and Incidence	219
Diagnosis	219
Pathology and Clinical Features	220
■ Further Readings	222

### GENERAL PRINCIPLES

*Amyloidosis* is a term for diseases that are due to the extracellular deposition of insoluble polymeric protein fibrils in tissues and organs. These diseases are a subset of a growing group of disorders caused by misfolding of proteins. Among these are Alzheimer's disease and other neurodegenerative diseases, transmissible prion diseases, and some genetic diseases caused by mutations that lead to misfolding and protein loss of function, such as certain of the cystic fibrosis mutations. Amyloid fibrils share a common  $\beta$ -pleated sheet structural conformation that confers unique staining properties. The name *amyloid* is attributed to the pathologist Virchow, who in 1854 thought such deposits were cellulose-like.

Amyloid diseases are defined by the biochemical nature of the protein in the fibril deposits and are classified according to whether they are systemic or localized, acquired or inherited, and by their clinical patterns (Table 17-1). The accepted nomenclature is *AX*, where *A* indicates amyloidosis and *X* represents the protein in the fibril. *AL* is amyloid composed of immunoglobulin (Ig) light chains (LCs), and is called *primary systemic amyloidosis*; it arises from a clonal B cell disorder, usually myeloma. *AF* groups the familial amyloidoses, most commonly due to transthyretin, the transport protein for thyroid hormone and retinol binding protein. *AA* amyloid is composed of the acute-phase reactant serum amyloid *A* protein and occurs in the setting of chronic inflammatory or infectious diseases. The disease associated with *AA*

amyloid is called *secondary amyloidosis*. *A $\beta$ <sub>2M</sub>* is amyloid composed of  $\beta$ <sub>2</sub>-microglobulin and occurs in individuals with end-stage renal disease (ESRD) of long duration. *A $\beta$*  is the most common form of localized amyloidosis. *A $\beta$*  is in the brain in Alzheimer's disease and is derived from abnormal proteolytic processing of the amyloid precursor protein (APP).

Diagnosis and treatment of the amyloidoses rests on the pathologic diagnosis of amyloid deposits and immunohistochemical or biochemical identification of amyloid type (Fig. 17-1). In the systemic amyloidoses, the involved organs can be biopsied, but amyloid deposits may be found in any tissue of the body. Historically, blood vessels of the gingiva or rectal mucosa were examined, but the most easily accessible tissue, positive in >80% of patients with systemic amyloid, is fat. After local anesthesia, needle aspiration of fat from the abdominal wall can be expelled onto a slide and stained, avoiding even a minor surgical procedure. If this material is negative, kidney biopsy, endomyocardial biopsy, liver biopsy, or an endoscopic biopsy can be considered. The regular  $\beta$  sheet structure of amyloid deposits exhibit a unique green birefringence by polarized light microscopy when stained with Congo red dye; the 10-nm diameter fibrils can be seen by electron microscopy. Once amyloid is found, the protein type must be determined, usually by immunohistochemistry or immunoelectron microscopy. Careful evaluation of the patient profile and clinical presentation, including age and ethnic origin, organ system involvement, underlying diseases, and family history should provide a clue to the type of amyloid.

TABLE 17-1

## AMYLOID FIBRIL PROTEINS AND THEIR PRECURSORS

AMYLOID PROTEIN	PRECURSOR	SYSTEMIC (S) OR LOCALIZED (L)	SYNDROME OR INVOLVED TISSUES
AL	Immunoglobulin light chain	S, L	Primary Myeloma-associated
AH	Immunoglobulin heavy chain	S, L	Primary Myeloma-associated
ATTR	Transthyretin	S	Familial Senile systemic
A $\beta$ <sub>2</sub> M	$\beta$ <sub>2</sub> -microglobulin	L?	Tenosynovium
		S	Hemodialysis
AA	(Apo)serum AA	L?	Joints
		S	Secondary, reactive
AApoAI	Apolipoprotein AI	S	Familial
AApoAII	Apolipoprotein AII	L	Aortic
		S	Familial
AGel	Gelsolin	S	Familial
ALys	Lysozyme	S	Familial
AFib	Fibrinogen $\alpha$ -chain	S	Familial
ACys	Cystatin C	S	Familial
ABri <sup>a</sup>	ABriPP	L, S?	Familial dementia, British
ADan <sup>a</sup>	ADanPP	L	<i>Familial dementia, Danish</i>
A $\beta$	A $\beta$ protein precursor (A $\beta$ PP)	L	Alzheimer's disease, aging
APrP	Prion protein	L	Spongiform encephalopathies
ACal	(Pro)calcitonin	L	C-cell thyroid tumors
AIAPP	Islet amyloid polypeptide	L	Islets of Langerhans Insulinomas
AANF	Atrial natriuretic factor	L	Cardiac atria
APro	Prolactin	L	Aging pituitary Prolactinomas
AIns	Insulin	L	Iatrogenic
AMed	Lactadherin	L	Senile aortic, media
AKer	Kerato-epithelin	L	Cornea; familial
A( <i>tbn</i> ) <sup>b</sup>	<i>tbn</i> <sup>b</sup>	L	<i>Pindborg tumors</i>
ALac	<i>Lactoferrin</i>	L	<i>Cornea; familial</i>

<sup>a</sup>ADan is coming from the same gene as ABri and has identical N-terminal sequence. It will be a matter of further discussion whether ADan should be included in the nomenclature as a separate protein (see text).

<sup>b</sup>To be named.

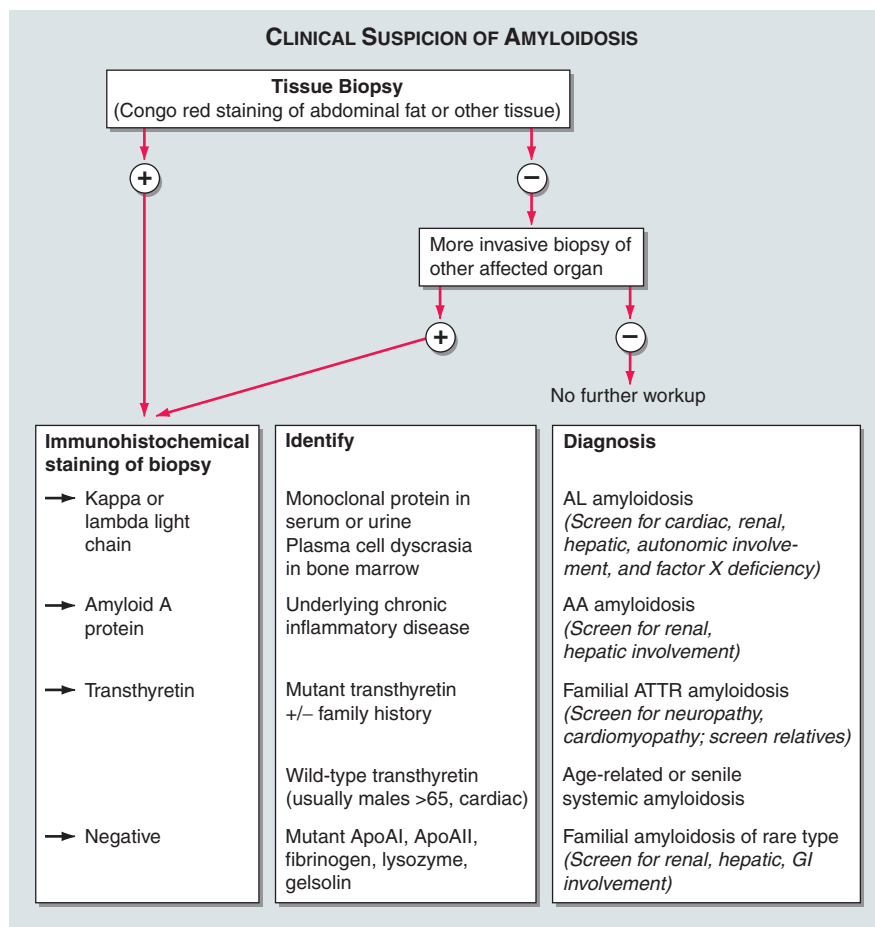
**Note:** Proteins in italics are preliminary.

**Source:** Reprinted from P Westermark et al: A primer of amyloid nomenclature. *Amyloid* 14(3):179–183, 2007. With permission from Taylor & Francis Ltd. (<http://www.tandf.co.uk/journals>).

The mechanisms of fibril formation and tissue toxicity remain controversial. A common underlying mechanism involves formation of intermolecular dimers by trans  $\beta$  sheet interactions of partially unfolded APP, leading to the formation of multimers and higher-order polymers. Factors that contribute to fibrillogenesis include variant or unstable protein structure; extensive  $\beta$ -sheet conformation of the precursor protein; proteolytic processing of the precursor protein; association with components of the serum or extracellular matrix (e.g., amyloid P-component, “amyloid enhancing factor” in spleen extracts, apolipoprotein E, or glycosaminoglycans); and local physical properties, including pH of the tissue. Once the fibrils reach a critical size, they become insoluble and deposit in

extracellular tissue sites. These macromolecular deposits interfere with organ function, at least in part due to cellular uptake of oligomeric amyloid precursors producing toxicity to target cells.

The clinical syndromes of the amyloidoses are associated with relatively nonspecific alterations in routine laboratory tests. Blood counts are usually normal, although the erythrocyte sedimentation rate is frequently elevated. Patients with renal involvement usually have proteinuria, which can be as much as 30 g/d, producing hypoalbuminemia <1 g/dL. Patients with cardiac involvement often have elevation of brain natriuretic peptide (BNP), pro-BNP, and troponin. These can be useful for monitoring disease activity and have been proposed as prognostic

**FIGURE 17-1**

**Algorithm for the diagnosis of amyloidosis and determination of type.** Clinical suspicion: unexplained nephropathy, cardiomyopathy, neuropathy, enteropathy, arthropathy, and

macroglossia. ApoAI, apolipoprotein AI; ApoAII, apolipoprotein AII; GI, gastrointestinal.

factors; they can be falsely elevated in the presence of renal insufficiency. Patients with liver involvement, even when it is advanced, usually develop cholestasis with an elevated alkaline phosphatase but minimal elevation of the transaminases and preservation of synthetic function. In AL amyloidosis, endocrinopathies can occur, with laboratory testing demonstrating hypothyroidism, hypoadrenalism, or even hypopituitarism. These findings are not specific for amyloidosis. Diagnosis of amyloidosis rests on two pillars: the identification of fibrillar deposits in tissues and the typing of the amyloid.

## AL AMYLOIDOSIS

### ETIOLOGY AND INCIDENCE

AL amyloidosis is most frequently caused by a clonal expansion of plasma cells in the bone marrow that secrete a clonal Ig LC that deposits as amyloid fibrils in tissues. It may be purely serendipitous whether the clonal plasma cells produce an LC that misfolds and produces AL

amyloidosis, or folds properly allowing the cells to inexorably expand over time and develop into multiple myeloma (Chap. 16). It is also possible that the two processes have differing molecular etiologies. AL amyloidosis can occur in multiple myeloma and other B lymphoproliferative diseases, including non-Hodgkin's lymphoma (Chap. 15) and Waldenström's macroglobulinemia (Chap. 16). AL amyloidosis is the most common type of systemic amyloidosis in North America. Its incidence has been estimated at 4.5 per 100,000; however, ascertainment continues to be inadequate, and the true incidence may be much higher. AL amyloidosis, like other plasma cell diseases, usually occurs after age 40 and is often rapidly progressive and fatal if untreated. It occurs in ~15% of myelomas. About 20% of all patients with AL amyloidosis have myeloma; the rest have other B cell disorders.

### DIAGNOSIS

Identification of a clonal plasma cell dyscrasia distinguishes AL from other types of amyloidosis. More than

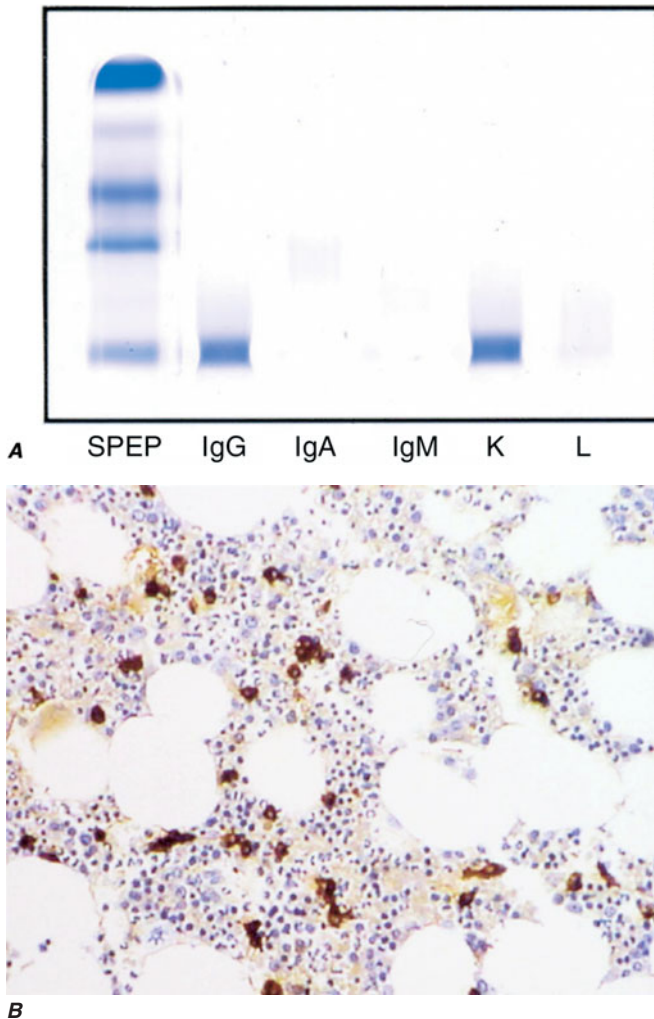
220 90% of patients have a serum or urine monoclonal Ig protein that can be detected by immunofixation electrophoresis (Fig. 17-2A) or free light chain assay. The standard serum protein electrophoresis (SPEP) and urine protein electrophoresis (UPEP) are not useful screening tests because the clonal Ig in AL amyloidosis, unlike in multiple myeloma, is often not present in sufficient quantity in the serum to produce a monoclonal “M-spike” by these tests. A commercially available nephelometric assay accurately quantifies abnormal LCs that circulate free of heavy chains in both multiple myeloma and AL amyloidosis. In AL, elevated levels of free LCs with a shift in the normal ratio of free kappa to lambda is seen

in 75% of patients. Lambda LCs are more common than kappa LCs in AL amyloidosis. Examining the ratio is essential because in renal failure free light chain clearance is reduced, and both types of LCs will be elevated. In addition, an increased percentage of plasma cells in the bone marrow is noted in ~90% of patients; those cells are monoclonal by immunohistochemical staining for kappa and lambda (Fig. 17-2B) or by fluorescence-activated cell sorter. However, a monoclonal serum protein by itself is not diagnostic of amyloidosis because monoclonal gammopathy of uncertain significance (MGUS) is common in older patients (Chap. 16). However, when MGUS is present in a patient with biopsy-proven amyloidosis, the AL type is strongly suspected. Immunohistochemical staining of the amyloid deposits is useful if they bind one light chain antibody in preference to the other; some AL deposits bind many antisera nonspecifically. Immunoelectron microscopy can be more reliable but is not widely available. Mass spectrometry-based microsequencing of small amounts of protein extracted from fibril deposits may ultimately be the most reliable way to identify the components of the fibrils. In ambiguous cases, other forms of amyloidosis should be thoroughly excluded.

## PATHOLOGY AND CLINICAL FEATURES

Amyloid deposits are usually widespread in AL amyloidosis and can be present in the interstitium of any organ except the central nervous system. The amyloid fibril deposits are composed of intact 23-kDa monoclonal Ig LCs or smaller fragments, 11–18 kDa in size, representing the variable (V) region alone, or the V region and a portion of the constant (C) region. Although all kappa and lambda LC subtypes have been identified in AL amyloid fibrils, lambda subtypes predominate, and the lambda VI subtype appears to have unique structural properties that predispose it to fibril formation, often in the kidney.

AL amyloidosis is usually a rapidly progressive disease that presents with characteristic clinical syndromes, recognition of which is key to making the diagnosis. Initial symptoms of fatigue and weight loss are common, but the diagnosis is rarely made until symptoms referable to a specific organ appear. The kidneys are the most frequently affected organ (80%). Renal amyloidosis is usually manifested by proteinuria, which is often in the nephrotic range and associated with significant hypoalbuminemia and edema or anasarca; rarely, tubular rather than glomerular deposition of amyloid can produce azotemia without significant proteinuria. Cardiac symptoms are the second most common presentation (40%), but cardiac dysfunction is associated with death in 75% of patients. The electrocardiogram may show low voltage with a pseudo-infarct pattern. With significant cardiac



**FIGURE 17-2**  
**Laboratory features of AL amyloidosis.** **A.** Serum immunofixation electrophoresis reveals an IgG $\kappa$  monoclonal protein; the serum protein electrophoresis is often normal. **B.** Bone marrow biopsy specimen in another patient, stained with antibody to  $\lambda$  light chain and developed with horseradish peroxidase, exhibits clonotypic  $\lambda$ -positive plasma cells (400 $\times$ ); antibody staining for  $\kappa$  would reveal few or no  $\kappa$ -positive cells. (Photomicrograph courtesy of C. O'Hara; with permission.)

involvement, the echocardiogram displays concentrically thickened ventricles (the interventricular septal thickness is a useful parameter to monitor) and diastolic dysfunction; however, systolic function is preserved until late in the disease. Nervous system features include a peripheral sensory neuropathy (18%), carpal tunnel syndrome (25%), and/or autonomic dysfunction with gastrointestinal motility disturbances (early satiety, diarrhea, constipation) and orthostatic hypotension (16%). Macroglossia, with an enlarged, indented, or immobile tongue, is pathognomonic of AL amyloidosis and is seen in 10% of patients. Hepatomegaly, seen in 34% of patients, may be massive with cholestatic liver function abnormalities, although liver failure is uncommon. The spleen is frequently involved, and there may be functional hyposplenism in the absence of significant splenomegaly. Many patients report “easy bruising” due to amyloid deposits in capillaries and deficiency of clotting factor X; cutaneous ecchymoses appear, particularly around the eyes, giving the “raccoon-eyes” sign. Other findings include nail dystrophy, alopecia, and amyloid arthropathy with thickening of synovial membranes (**Fig. 17-3**).

### Rx Treatment: AL AMYLOIDOSIS

Extensive multisystem involvement typifies AL amyloidosis, and median survival with no treatment is usually ~1 year from the time of diagnosis. Current therapies target the clonal bone marrow plasma cells using approaches employed for multiple myeloma. Treatment with cyclic oral melphalan and prednisone can decrease the plasma cell burden but produces complete hematologic remission in only a few percent of patients and minimal organ responses and improvement in survival (median: 2 years). The substitution of pulses of high-dose dexamethasone for prednisone produces a higher response rate and more durable remissions, although dexamethasone is not always well tolerated by patients with significant edema or cardiac disease. High-dose intravenous melphalan followed by autologous stem cell transplantation is far more effective than oral melphalan and prednisone. Complete hematologic response rates are ~40%, as measured by complete loss of clonal plasma cells in the bone marrow and disappearance of the monoclonal LC by immunofixation



A



C



B

**FIGURE 17-3**

**Clinical signs of AL amyloidosis. A.** Macroglossia. **B.** Periorbital ecchymoses. **C.** Fingernail dystrophy.

electrophoresis. In patients without a complete hematologic response, a significant improvement is often seen in hematologic parameters. Similar rates of improvement are seen in organ function and quality of life, with an extended survival exceeding that previously seen in this disease. The complete hematologic responses appear to be more durable than those seen in multiple myeloma and may even signal cure; remissions of >10 years are documented. Unfortunately, only about half of AL amyloidosis patients are eligible for such aggressive treatment, and even at specialized treatment centers, peri-transplant mortality is higher than for other hematologic diseases because of impaired organ function. Amyloid cardiomyopathy, poor nutritional status, impaired performance status, and multiple-organ disease contribute to excess morbidity and mortality. The bleeding diathesis due to adsorption of clotting factor X to amyloid fibrils also confers high mortality during myelosuppressive therapy; however, this syndrome occurs in only a few percent of patients. Age alone, or renal insufficiency, does not have a major impact on morbidity or outcome, and these factors alone should not exclude patients from such treatment. In selected patients, tandem transplantation may offer an even higher rate of hematologic response.

For patients with impaired cardiac function or arrhythmias due to amyloid involvement of the myocardium, median survival is only ~6 months without treatment, and stem cell mobilization and high-dose chemotherapy are dangerous. In these patients, cardiac transplantation can be performed, followed by treatment with high-dose melphalan and stem cell rescue to prevent amyloid deposition in the transplanted heart or other organs. Thalidomide and lenalidomide have activity; lenalidomide is reasonably well-tolerated and, particularly in combination with dexamethasone, produces complete hematologic remissions and improvement in organ function. Novel agents such as the proteasome inhibitor bortezomib are also under investigation for AL amyloidosis.

Supportive care is important for patients with any type of amyloidosis. For nephrotic syndrome, diuretics and supportive stockings can ameliorate edema; angiotensin-converting enzyme inhibitors should be used with caution and have not been shown to slow renal disease progression. Congestive heart failure due to amyloid cardiomyopathy is also best treated with diuretics; it is important to note that digitalis, calcium channel blockers, and beta blockers are relatively

contraindicated because they can interact with amyloid fibrils and produce heart block and worsening heart failure. Amiodarone has been used for atrial and ventricular arrhythmias. Automatic implantable defibrillators have reduced effectiveness due to the thickened myocardium. Atrial ablation is another effective approach for atrial fibrillation. For conduction abnormalities, ventricular pacing may be indicated. Atrial contractile dysfunction is common in amyloid cardiomyopathy and an indication for anticoagulation. Autonomic neuropathy can be treated with  $\alpha$  agonists such as midodrine to support the blood pressure; gastrointestinal dysfunction may respond to motility or bulk agents. Nutritional supplementation, either orally or parenterally, is also important.

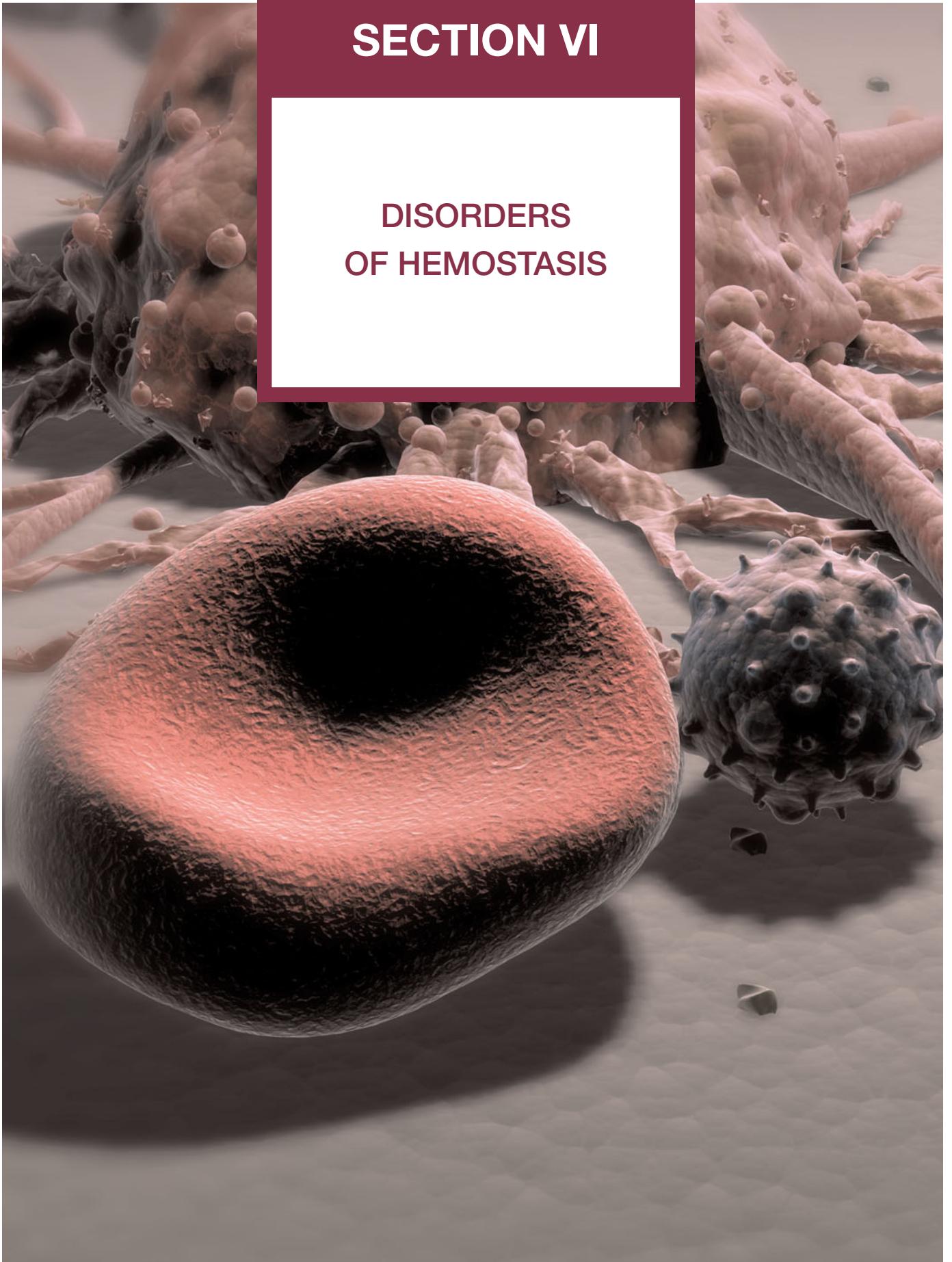
In localized AL, amyloid deposits can be produced by clonal plasma cells infiltrating local sites in the airways, bladder, skin, or lymph nodes (Table 17-1). Deposits may respond to surgical intervention or radiation therapy; systemic treatment is generally not appropriate. Patients should be referred to a center familiar with management of these rare manifestations of amyloidosis.

## FURTHER READINGS

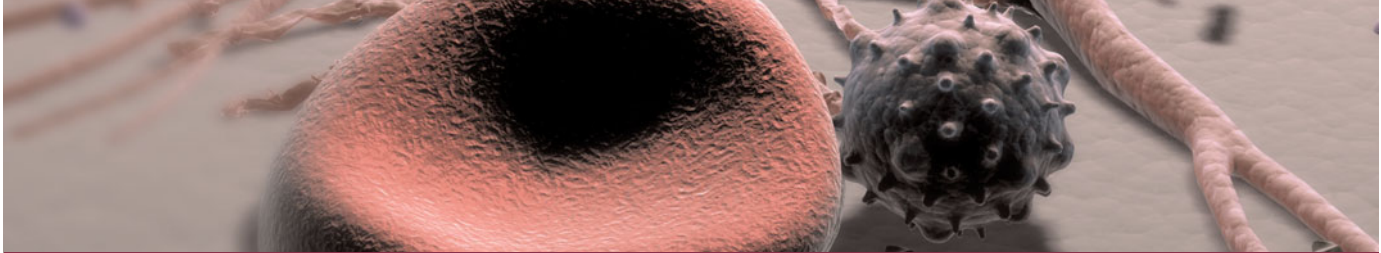
- AKAR H et al: Quantitative serum free light-chain assay in the diagnostic evaluation of AL amyloidosis. *Amyloid J Protein Folding Disorders* 12:210, 2005
- BENSON M: Amyloidosis, in *The Metabolic and Molecular Bases of Inherited Disease*, 8th ed, CR Scriver et al (eds). New York, McGraw-Hill, 2001, pp 5345–5378
- COMENZO RL: How I treat amyloidosis. *Blood* 114:3147, 2009
- DEMBER LM et al: Effect of intravenous melphalan and autologous blood stem cell transplant on AL amyloidosis–associated renal disease. *Ann Intern Med* 134:746, 2001
- MERLINI G, BELLOTTI V: Molecular mechanisms of amyloidosis. *N Engl J Med* 349:583, 2003
- PALLADINI G, MERLINI G: Current treatment of AL amyloidosis. *Haematologica* 94:1044, 2009
- RAJKUMAR SV, GERTZ MA: Advances in the treatment of amyloidosis. *N Engl J Med* 356:2413, 2007
- SELDIN DC et al: Improvement in quality of life of patients with AL amyloidosis treated with high-dose melphalan and autologous stem cell transplantation. *Blood* 104:1888, 2004
- et al: Successful treatment of AL amyloidosis with high-dose melphalan and autologous stem cell transplantation in patients over age 65. *Blood* 108:3945, 2006
- SIDERIS K, GERTZ MA: Amyloidosis. *Adv Clin Chem* 47:1, 2009
- SKINNER M et al: High-dose melphalan and autologous stem-cell transplantation in patients with AL amyloidosis: An 8-year study. *Ann Intern Med* 140:85, 2004

# SECTION VI

## DISORDERS OF HEMOSTASIS







## CHAPTER 18

# DISORDERS OF PLATELETS AND VESSEL WALL

Barbara A. Konkle

The Platelet .....	224
The Vessel Wall .....	225
■ Disorders of Platelets .....	225
Thrombocytopenia .....	225
Thrombotic Thrombocytopenic Purpura and Hemolytic Uremic Syndrome .....	229
Thrombocytosis .....	231
Qualitative Disorders of Platelet Function .....	231
Von Willebrand's Disease .....	231
■ Disorders of the Vessel Wall .....	233
Metabolic and Inflammatory Disorders .....	233
Inherited Disorders of the Vessel Wall .....	234
■ Further Readings .....	234

Hemostasis is a dynamic process in which the platelet and the blood vessel wall play key roles. Platelets become activated upon adhesion to von Willebrand's factor (vWF) and collagen in the exposed subendothelium after injury. Platelet activation is also mediated through shear forces imposed by blood flow itself, particularly in areas where the vessel wall is diseased, and is also affected by the inflammatory state of the endothelium. The activated platelet surface provides the major physiologic site for coagulation factor activation, which results in further platelet activation and fibrin formation. Genetic and acquired influences on the platelet and vessel wall, as well as on the coagulation and fibrinolytic systems, determine whether normal hemostasis, or bleeding or clotting symptoms, will result.

### THE PLATELET

Platelets are released from the megakaryocyte, likely under the influence of flow in the capillary sinuses. The normal blood platelet count is 150,000–450,000/ $\mu\text{L}$ . The major

regulator of platelet production is the hormone thrombopoietin (TPO), which is synthesized in the liver. Synthesis is increased with inflammation and specifically by interleukin 6. TPO binds to its receptor on platelets and megakaryocytes, by which it is removed from the circulation. Thus a reduction in platelet and megakaryocyte mass increases the level of TPO, which then stimulates platelet production. Platelets circulate with an average life span of 7–10 days. Approximately a third of the platelets reside in the spleen, and this number increases in proportion to splenic size, although the platelet count rarely decreases to  $<40,000/\mu\text{L}$  as the spleen enlarges. Platelets are physiologically very active but are anucleate, and thus they have limited capacity to synthesize new proteins.

Normal vascular endothelium contributes to preventing thrombosis by inhibiting platelet function (Chap. 3). When vascular endothelium is injured, these inhibitory effects are overcome, and platelets adhere to the exposed intimal surface primarily through vWF, a large multimeric protein present in both plasma and in the extracellular matrix of the subendothelial vessel wall. Platelet adhesion

results in the generation of intracellular signals that lead to activation of the platelet glycoprotein (Gp) IIb/IIIa ( $\alpha_{IIb}\beta_3$ ) receptor and resultant platelet aggregation.

Activated platelets undergo release of their granule contents, including nucleotides, adhesive proteins, growth factors, and procoagulants that serve to promote platelet aggregation and blood clot formation, and influence the environment of the forming clot. During platelet aggregation, additional platelets are recruited to the site of injury, leading to the formation of an occlusive platelet thrombus. The platelet plug is stabilized by the fibrin mesh that develops simultaneously as the product of the coagulation cascade.

## THE VESSEL WALL

Endothelial cells line the surface of the entire circulatory tree, totaling  $1-6 \times 10^{13}$  cells, enough to cover a surface area equivalent to about six tennis courts. The endothelium is physiologically active, controlling vascular permeability, flow of biologically active molecules and nutrients, blood cell interactions with the vessel wall, the inflammatory response, and angiogenesis.

The endothelium normally presents an antithrombotic surface (Chap. 3) but rapidly becomes prothrombotic when stimulated, which promotes coagulation, inhibits fibrinolysis, and activates platelets. In many cases, endothelium-derived vasodilators are also platelet inhibitors (e.g., nitric oxide) and, conversely, endothelium-derived vasoconstrictors (e.g., endothelin) can also be platelet activators. The net effect of vasodilation and inhibition of platelet function is to promote blood fluidity, whereas the net effect of vasoconstriction and platelet activation is to promote hemostasis. Thus blood fluidity and hemostasis are regulated by the balance of antithrombotic/prothrombotic and vasodilatory/vasoconstrictor properties of endothelial cells.

## DISORDERS OF PLATELETS

### THROMBOCYTOPENIA

Thrombocytopenia results from one or more of three processes: (1) decreased bone marrow production; (2) sequestration, usually in an enlarged spleen; and/or (3) increased platelet destruction. Disorders of production may be either inherited or acquired. In evaluating a patient with thrombocytopenia, a key step is to review the peripheral blood smear and to first rule out “pseudothrombocytopenia,” particularly in a patient without an apparent cause for the thrombocytopenia. Pseudothrombocytopenia (Fig. 18-1B) is an *in vitro* artifact resulting from platelet agglutination via antibodies (usually IgG, but also IgM and IgA) when the calcium content is decreased by blood collection in ethylenediamine tetraacetic (EDTA), the anticoagulant present in tubes (purple top, often) used to collect

blood for complete blood counts (CBCs). If a low platelet count is obtained in EDTA-anticoagulated blood, a blood smear can be evaluated and a platelet count determined in blood collected into sodium citrate (blue-top tube) or heparin (green-top tube), or ideally a smear of freshly obtained unanticoagulated blood, such as from a fingerstick, can be examined.

### Approach to the Patient: THROMBOCYTOPENIA

The history and physical examination, results of the CBC, and review of the peripheral blood smear are all critical components in the initial evaluation of the thrombocytopenic patients (Fig. 18-2). The overall health of the patient and whether he or she is receiving drug treatment will influence the differential diagnosis. A healthy young adult with thrombocytopenia will have a much more limited differential diagnosis than an ill hospitalized patient who is receiving multiple medications. Except in unusual inherited disorders, decreased platelet production usually results from bone marrow disorders that also affect red blood cell (RBC) and/or white blood cell (WBC) production. Because myelodysplasia can present with isolated thrombocytopenia, the bone marrow should be examined in patients presenting with isolated thrombocytopenia who are >60 years of age. Although inherited thrombocytopenia is rare, any prior platelet counts should be retrieved and a family history regarding thrombocytopenia obtained. A careful history of drug ingestion should be obtained, including nonprescription and herbal remedies, because drugs are the most common cause of thrombocytopenia.

The physical examination can document an enlarged spleen, evidence of chronic liver disease, and other underlying disorders. Mild to moderate splenomegaly may be difficult to appreciate in many individuals due to body habitus and/or obesity but can be easily assess by abdominal ultrasound. A platelet count of ~5000–10,000 is required to maintain vascular integrity in the microcirculation. When the platelet count is markedly decreased, petechiae first appear in areas of increased venous pressure, the ankles and feet in an ambulatory patient. Petechiae are pinpoint, non-blanching hemorrhages and are usually a sign of a decreased platelet number and not platelet dysfunction. Wet purpura, blood blisters that form on the oral mucosa, are thought to denote an increased risk of life-threatening hemorrhage in the thrombocytopenic patient. Excessive bruising is seen in disorders of both platelet number and function.

### Infection-Induced Thrombocytopenia

Many viral and bacterial infections result in thrombocytopenia and are the most common noniatrogenic cause

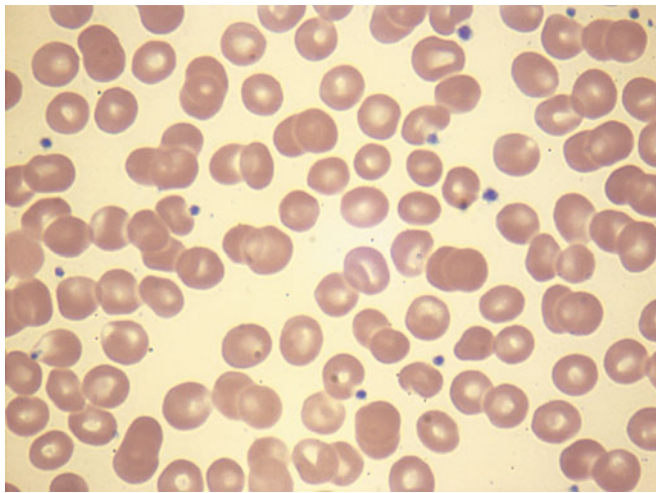
226 of thrombocytopenia. This may or may not be associated with laboratory evidence of disseminated intravascular coagulation (DIC), which is most commonly seen in patients with systemic infections with gram-negative bacteria. Infections can affect both platelet production and platelet survival. In addition, immune mechanisms can be at work, as in infectious mononucleosis and early HIV infection. Late in HIV infection, pancytopenia and decreased and dysplastic platelet production is more common. Immune-mediated thrombocytopenia (ITP2) in children usually follows a viral infection and almost always resolves spontaneously. This association of infection with ITP is less clear in adults.

Bone marrow examination is often requested for evaluation of occult infections. A study evaluating the role of bone marrow examination in fever of unknown origin in HIV-infected patients found that for 86% of patients, the same diagnosis was established by less invasive techniques, notably blood culture. In some instances, however, the

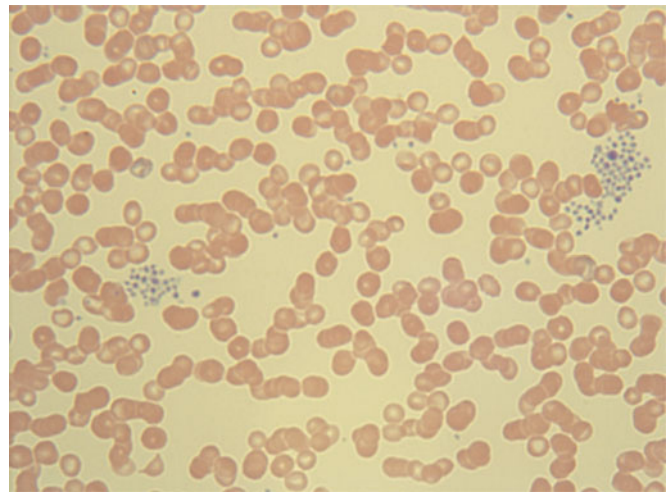
diagnosis can be made earlier; thus a bone marrow examination and culture is recommended when the diagnosis is needed urgently or when other, less invasive methods have been unsuccessful.

### Drug-Induced Thrombocytopenia

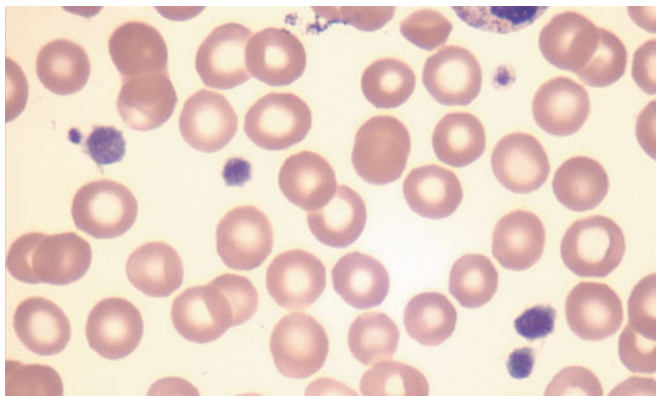
Many drugs have been associated with thrombocytopenia. A predictable decrease in platelet count occurs after treatment with many chemotherapeutic drugs due to bone marrow suppression (Chap. 27). Other commonly used drugs that cause isolated thrombocytopenia are listed in **Table 18-1**, but all drugs should be suspect in a patient with thrombocytopenia without an apparent cause and should be stopped, or substituted, if possible. A helpful website, Platelets on the Internet (<http://moon.ouhsc.edu/jgeorge>), lists drugs reported to have caused thrombocytopenia and the level of evidence supporting the association. Although not well studied, herbal and



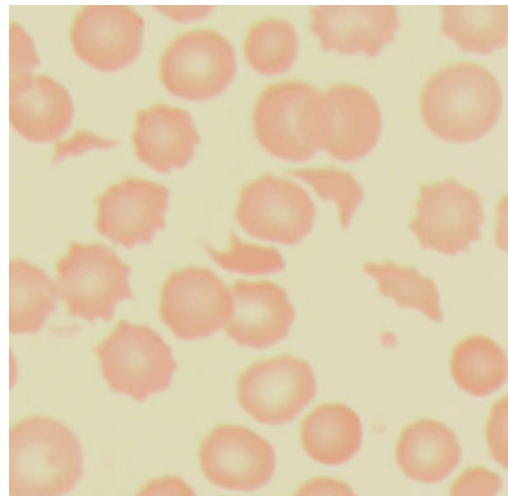
A



B



C

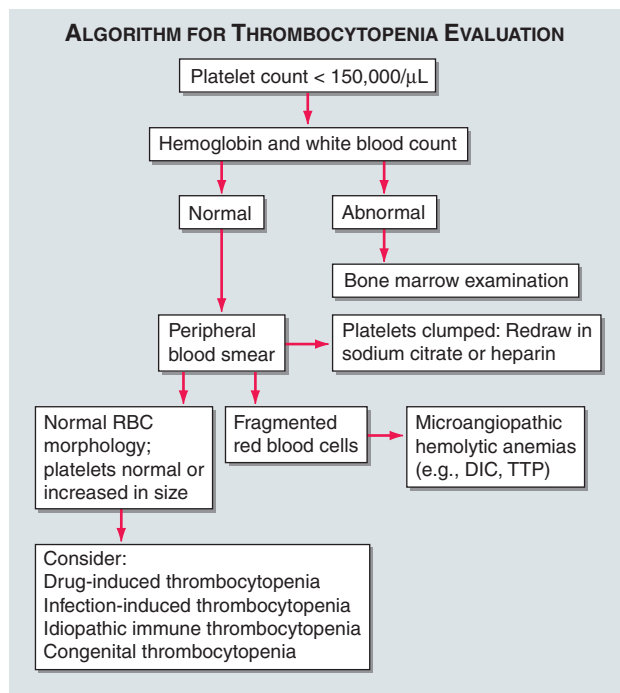


D

**FIGURE 18-1**

**Photomicrographs of peripheral blood smears.** **A.** Normal peripheral blood. **B.** Platelet clumping in pseudothrombocytopenia. **C.** Abnormal large platelet in autosomal dominant

macrothrombocytopenia. **D.** Schistocytes and decreased platelets in microangiopathic hemolytic anemia.



**FIGURE 18-2**  
Algorithm for evaluating the thrombocytopenic patient.

over-the-counter preparations may also result in thrombocytopenia and should be discontinued in patients who are thrombocytopenic.

Classic drug-dependent antibodies are antibodies that react with specific platelet surface antigens and result in thrombocytopenia only when the drug is present. Many drugs are capable of inducing these antibodies, but for some reason they are more common with quinine and sulfonamides. Drug-dependent antibody binding can be

**TABLE 18-1**  
**DRUGS DEFINITELY REPORTED TO CAUSE ISOLATED THROMBOCYTOPENIA<sup>a</sup>**

Abciximab	Digoxin
Acetaminophen	Eptifibatid
Acyclovir	Hydrochlorothiazide
Aminosalicylic acid	Ibuprofen
Amiodarone	Levamisole
Amphotericin B	Octreotide
Ampicillin	Phenytoin
Carbamazepine	Quinine
Chlorpropamide	Rifampin
Danazol	Tamoxifen
Diatrizoate meglumine (Hypaque Meglumine)	Tirofiban
Diclofenac	Trimethoprim/sulfamethoxazole
	Vancomycin

<sup>a</sup>Drugs that preceded thrombocytopenia and full recovery occurred after drug discontinuation, but recurred with reintroduction of the drug, and other causes, including other drugs were excluded.

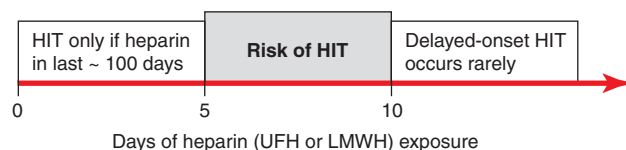
**Source:** Data from George and colleagues, <http://moon.ouhsc.edu/jgeorge>.

demonstrated by laboratory assays, showing antibody binding in the presence of, but not without, the drug present in the assay. The thrombocytopenia typically occurs after a period of initial exposure (median length: 21 days), or upon reexposure, and usually resolves in 7–10 days after drug withdrawal. The thrombocytopenia caused by the platelet GpIIb/IIIa inhibitory drugs, such as abciximab, differs in that it may occur within 24 h of initial exposure. This appears to be due to the presence of naturally occurring antibodies that cross-react with the drug bound to the platelet.

### Heparin-Induced Thrombocytopenia

Drug-induced thrombocytopenia due to heparin differs from that seen with other drugs in two major ways. (1) The thrombocytopenia is not usually severe, with nadir counts rarely  $<20,000/\mu\text{L}$ . (2) Heparin-induced thrombocytopenia (HIT) is not associated with bleeding and, in fact, markedly increases the risk of thrombosis. HIT results from antibody formation to a complex of the platelet-specific protein platelet factor 4 (PF4) and heparin. The antiheparin/PF4 antibody can activate platelets through the Fc $\gamma$ RIIa receptor and also likely activates endothelial cells. Many patients exposed to heparin develop antibodies to heparin/PF4 but do not appear to have adverse consequences. A fraction of those who develop antibodies develop thrombocytopenia, and a portion of those (up to 50%) develop HIT and thrombosis (HITT).

HIT can occur after exposure to low-molecular-weight heparin (LMWH), as well as unfractionated heparin (UFH), although it is  $\sim 10$  times more common with the latter. Most patients develop HIT after exposure to heparin for 5–10 days (Fig. 18-3). It occurs before 5 days only in those who were exposed to heparin in the prior few weeks or months ( $< \sim 100$  days) and have circulating antiheparin/PF4 antibodies. Rarely, thrombocytopenia and thrombosis begin several days after all heparin has been stopped (termed *delayed-onset HIT*). The “4 T’s” have been recommended as a diagnostic algorithm for HIT:



**FIGURE 18-3**  
**Time course of heparin-induced thrombocytopenia (HIT) development after heparin exposure.** The timing of development after heparin exposure is a critical factor in determining the likelihood of HIT in a patient. HIT occurs early in heparin exposure only in the presence of preexisting heparin/platelet factor 4 (PF4) antibodies, which disappear from circulation by  $\sim 100$  days following a prior exposure. Rarely, HIT may occur later after heparin exposure (termed *delayed-onset HIT*). In this setting, heparin/PF4 antibody testing is markedly positive. HIT can occur after exposure to either unfractionated heparin (UFH) or low-molecular-weight heparin (LMWH).

228 thrombocytopenia, timing of platelet count drop, thrombosis and other sequelae such as localized skin reactions, and other cause of thrombocytopenia not evident.

### Laboratory Testing for HIT

HIT (antiheparin/PF4) antibodies can be detected using two types of assays. The most widely available is an enzyme-linked immunosorbent assay (ELISA) with PF4/polyanion complex as the antigen. Because many patients develop antibodies but do not develop clinical HIT, the test has a low specificity for the diagnosis of HIT. This is especially true in patients who have undergone cardiopulmonary bypass surgery, where ~50% of patients develop these antibodies postoperatively. The other assay is a platelet activation assay that measures the ability of the patients' serum to activate platelets in the presence of heparin in a concentration-dependent manner. This test has lower sensitivity but higher specificity than the ELISA. However, HIT remains a clinical diagnosis. The main value in testing is in excluding the diagnosis with negative tests, particularly ELISA.

### **Rx** Treatment: HEPARIN-INDUCED THROMBOCYTOPENIA

Early recognition is key in treatment of HIT, with prompt discontinuation of heparin and use of alternative anticoagulants. Thrombosis is a common complication of HIT, even after heparin discontinuation, and it can occur in both the venous and arterial systems. In patients diagnosed with HIT, imaging studies to evaluate the presence of thrombosis (at least lower-extremity duplex Dopplers) are recommended. Patients requiring anticoagulation should be switched from heparin to an alternative anticoagulant. The direct thrombin inhibitors (DTIs) argatroban and lepirudin are effective in HIT. The DTI bivalirudin and the antithrombin-binding pentasaccharide fondaparinux appear to be effective but are not yet approved by the U.S. Food and Drug Administration (FDA) for this indication. Danaparoid, a mixture of glycosaminoglycans with anti-Xa activity, has been used extensively for the treatment of HIT; it is no longer available in the United States but is in other countries. HIT antibodies cross-react with LMWH, and these preparations should not be used in the treatment of HIT.

Because of the high rate of thrombosis in patients with HIT, anticoagulation should be strongly considered, even in the absence of thrombosis. In patients with thrombosis, patients can be transitioned to warfarin, with treatment usually for 3–6 months. In patients without thrombosis, the duration of anticoagulation needed is undefined. An increased risk of thrombosis is present for at least 1 month after diagnosis; however, most thromboses occur early, and whether thrombosis occurs later if

the patient is initially anticoagulated is unknown. Options include continuing anticoagulation until a few days after platelet recovery or for 1 month. Introduction of warfarin alone in the setting of HIT or HITT may precipitate thrombosis, particularly venous gangrene, presumably due to clotting activation and severely reduced levels of proteins C and S. Warfarin should only be started after alternative anticoagulation has been given for several days and the prothrombotic state has lessened.

### Immune Thrombocytopenic Purpura (ITP)

Immune thrombocytopenic purpura (ITP; also termed *idiopathic thrombocytopenic purpura*) is an acquired disorder leading to immune-mediated destruction of platelets and possibly inhibition of platelet release from the megakaryocyte. In children it is usually an acute disease, most commonly following an infection, and with a self-limited course. In adults it usually runs a more chronic course. The exact nature of the immune dysfunction is generally not known. ITP is termed *secondary* if it is associated with an underlying disorder; autoimmune disorders, particularly systemic lupus erythematosus (SLE), and infections, such as HIV and hepatitis C, are common causes. The association of ITP with *Helicobacter pylori* infection is unclear.

ITP is characterized by mucocutaneous bleeding and a low, often very low, platelet count, with otherwise normal peripheral blood cells and smear. Patients usually present either with ecchymoses and petechiae, or with thrombocytopenia incidentally found on a routine CBC. Mucocutaneous bleeding, such as oral mucosa, gastrointestinal, or heavy menstrual bleeding, may be present. Rarely, life-threatening bleeding, including in the central nervous system, can occur. Wet purpura (blood blisters in the mouth) and retinal hemorrhages may herald life-threatening bleeding.

### Laboratory Testing in ITP

Laboratory testing for antibodies (serologic testing) is usually not helpful due to the low sensitivity and specificity of the tests. Bone marrow examination can be reserved for older adults (usually >60 years) or those who have other signs or laboratory abnormalities not explained by ITP, or in patients who do not respond to initial therapy. The peripheral blood smear may show large platelets, with otherwise normal morphology. Depending on the bleeding history, iron-deficiency anemia may be present.

Laboratory testing is performed to evaluate for secondary causes of ITP and should include testing for HIV infection and hepatitis C (and other infections if indicated); serologic testing for SLE; serum protein electrophoresis and immunoglobulin levels to potentially detect hypogammaglobulinemia, IgA deficiency, or monoclonal gammopathies; and, if anemia is present, direct antiglobulin testing (Coombs test) to rule out

combined autoimmune hemolytic anemia with ITP (Evans's syndrome).

## **R<sub>x</sub>** **Treatment:** **IMMUNE THROMBOCYTOPENIC PURPURA**

The treatment of ITP uses drugs that decrease reticuloendothelial uptake of the antibody-bound platelet and/or decrease antibody production. However, the diagnosis of ITP does not necessarily mean that treatment must be instituted. Patients with platelet counts  $>30,000/\mu\text{L}$  appear not to have increased mortality related to the thrombocytopenia.

Initial treatment in patients without significant bleeding symptoms, severe thrombocytopenia ( $<5000/\text{mL}$ ), or signs of impending bleeding (such as retinal hemorrhage or large oral mucosal hemorrhages) can be instituted as an outpatient using single agents. Traditionally this has been prednisone at 1 mg/kg, although Rh<sub>0</sub>(D) immune globulin therapy (WinRho SDF) at 50–75  $\mu\text{g}/\text{kg}$  is also being used in this setting. Rh<sub>0</sub>(D) immune globulin must be used only in Rh+ patients because the mechanism of action is production of limited hemolysis, with antibody-coated cells "saturating" the Fc receptors, inhibiting Fc receptor function. Hemoglobin levels usually decrease (mean: 1.7 g/dL), although severe intravascular hemolysis is a rare complication. Doses are reduced if given to anemic patients. Intravenous gamma globulin (IVIgG), which is pooled, primarily IgG antibodies, also blocks the Fc receptor system but appears to work primarily through different mechanism(s). IVIgG has more efficacy than anti-Rh<sub>0</sub>(D) in post-splenectomized patients. IVIgG is dosed at 2 g/kg total, given in divided doses over 2–5 days. Side effects are usually related to the volume of infusion and infrequently include aseptic meningitis and renal failure. All immunoglobulin preparations are derived from human plasma and undergo treatment for viral inactivation.

For patients with severe ITP and/or symptoms of bleeding, hospital admission and combined modality therapy are given using high-dose glucocorticoids with IVIgG or anti-Rh<sub>0</sub>D therapy, and, as needed, additional immunosuppressive agents. Rituximab, an anti-CD20 (B cell) antibody, has shown efficacy in the treatment of refractory ITP.

Splenectomy has been used for treatment of patients who relapse after glucocorticoids are tapered. Splenectomy remains an important treatment option; however, more patients than previously thought will go into a remission over time. Observation, if the platelet count is high enough, or intermittent treatment with anti-Rh<sub>0</sub>(D) or IVIgG may be a reasonable approach to see if the ITP will resolve. Vaccination against encapsulated organisms (especially pneumococcus, but also meningococcus and *Haemophilus influenzae*, depending on patient age and

potential exposure) is recommended before splenectomy. Accessory spleen(s) are a very rare cause of relapse.

New drugs for ITP include TPO receptor agonists. This approach to treatment of ITP stems from the finding that many patients with ITP do not have increased TPO levels, as previously hypothesized, nor do they all have increased platelet destruction. Two agents, one administered subcutaneously and another orally, have shown response in many patients with refractory ITP. Roles for these agents in ITP treatment are not fully defined.

### **Inherited Thrombocytopenia**

Thrombocytopenia is rarely inherited, either as an isolated finding or as part of a syndrome, and may be inherited in an autosomal dominant, autosomal recessive, or X-linked pattern. Many forms of autosomal dominant thrombocytopenia are now known to be associated with mutations in the nonmuscle myosin heavy chain *MYH9* gene. Interestingly, these include the May-Hegglin anomaly and Sebastian's, Epstein's, and Fechner's syndromes, all of which have distinct distinguishing features. A common feature of these disorders is large platelets (Fig. 18-1C). Autosomal recessive disorders include congenital amegakaryocytic thrombocytopenia, thrombocytopenia with absent radii, and Bernard-Soulier syndrome. The latter is primarily a functional platelet disorder due to absence of GPIb-IX-V, the vWF adhesion receptor. X-linked disorders include Wiskott-Aldrich syndrome and a dyshematopoietic syndrome resulting from a mutation in *GATA-1*, an important transcriptional regulator of hematopoiesis.

### **THROMBOTIC THROMBOCYTOPENIC PURPURA AND HEMOLYTIC UREMIC SYNDROME**

Thrombotic thrombocytopenic microangiopathies are a group of disorders characterized by thrombocytopenia, a microangiopathic hemolytic anemia evident by fragmented RBCs (Fig. 18-1D) and laboratory evidence of hemolysis, and microvascular thrombosis. This includes thrombotic thrombocytopenic purpura (TTP) and hemolytic uremic syndrome (HUS), as well as syndromes complicating bone marrow transplantation, certain medications and infections, pregnancy, and vasculitis. In DIC, although thrombocytopenia and microangiopathy are seen, a coagulopathy predominates, with consumption of clotting factors and fibrinogen resulting in an elevated prothrombin time (PT) and often activated partial thromboplastin time (aPTT). The PT and aPTT are characteristically normal in TTP or HUS.

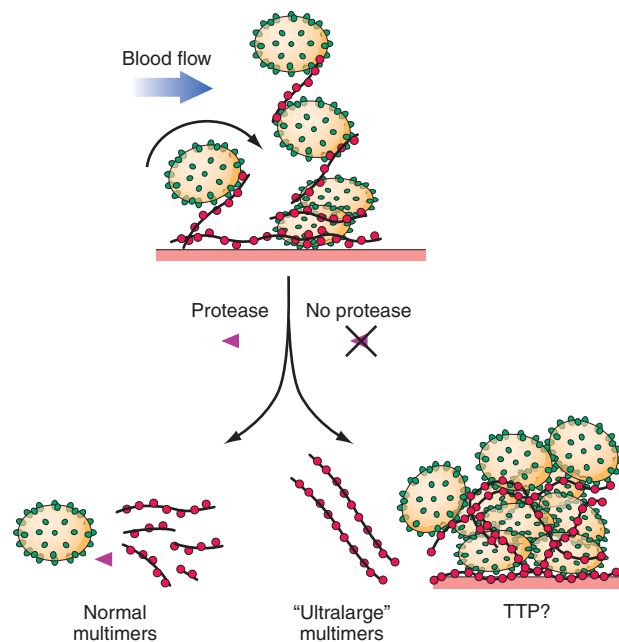
#### **Thrombotic Thrombocytopenic Purpura**

TTP and HUS were previously considered overlap syndromes. However, in the past few years the pathophysiology

230 of inherited and idiopathic TTP has become better understood and clearly differs from HUS. TTP was first described in 1924 by Eli Moschowitz and characterized by a pentad of findings that include microangiopathic hemolytic anemia, thrombocytopenia, renal failure, neurologic findings, and fever. The full-blown syndrome is less commonly seen now, probably due to earlier diagnosis. The introduction of treatment with plasma exchange markedly improved the prognosis in patients, with a decrease in mortality from 85–100% to 10–30%.

The pathogenesis of inherited (Upshaw-Schulman syndrome) and idiopathic TTP is related to a deficiency of, or antibodies to, a metalloprotease that cleaves vWF and ADAMTS13, respectively. vWF is normally secreted as ultra-large multimers, which are then cleaved by ADAMTS13. The persistence of ultra-large vWF molecules are thought to contribute to pathogenic platelet adhesion and aggregation (Fig. 18-4). This defect alone, however, is not sufficient to result in TTP because individuals with a congenital absence of ADAMTS13 develop TTP only episodically. Additional provocative factors have not been defined. The level of ADAMTS13 activity, as well as antibodies, can now be detected by laboratory assays. However, assays with sufficient sensitivity and specificity to direct clinical management have yet to be defined.

**vWF and Platelet Adhesion**



**FIGURE 18-4**  
**Pathogenesis of thrombotic thrombocytopenic purpura (TTP).** Normally the ultra-high molecular-weight multimers of von Willebrand’s factor (vWF) produced by the endothelial cells are processed into smaller multimers by a plasma metalloproteinase called ADAMTS13. In TTP the activity of the protease is inhibited, and the ultra-high molecular-weight multimers of vWF initiate platelet aggregation and thrombosis. (From Vesely et al., Copyright American Society of Hematology.)

Idiopathic TTP appears to be more common in women than in men. No geographic or racial distribution has been defined. TTP is more common in patients with HIV infection and in pregnant women. Medication-related TTP may be secondary to antibody formation (ticlopidine and possibly clopidogrel) or direct endothelial toxicity (cyclosporine, mitomycin C, tacrolimus, quinine), although this is not always so clear, and fear of withholding treatment, as well as lack of other treatment alternatives, results in broad application of plasma exchange. However, withdrawal, or reduction in dose, of endothelial toxic agents may decrease the microangiopathy.

**Treatment:**  
**Rx THROMBOTIC THROMBOCYTOPENIC PURPURA**

TTP is a devastating disease if not diagnosed and treated promptly. In patients presenting with new thrombocytopenia, with or without evidence of renal insufficiency and other elements of classic TTP, laboratory data should be obtained to rule out DIC and to evaluate for evidence of microangiopathic hemolytic anemia. Findings to support the TTP diagnosis include an increased lactate dehydrogenase and indirect bilirubin, decreased haptoglobin, and increased reticulocyte count, with a negative direct antiglobulin test. The peripheral smear should be examined for evidence of schistocytes (Fig. 18-1D). Polychromasia is usually also present due to the increased number of young red blood cells, and nucleated RBCs are often present, which is thought to be due to infarction in the microcirculatory system of the bone marrow.

Plasma exchange remains the mainstay of treatment of TTP. ADAMTS13 antibody-mediated TTP (idiopathic TTP) appears to respond best to plasma exchange. Plasma exchange is continued until the platelet count is normal and signs of hemolysis are resolved for at least 2 days. Although never evaluated in clinical trial, the use of glucocorticoids seems a reasonable approach, but they should only be used as an adjunct to plasma exchange. Additionally, other immunomodulatory therapies have been reported to be successful in refractory or relapsing TTP, including rituximab, vincristine, cyclophosphamide, and splenectomy. The role of rituximab in the treatment of this disorder needs to be defined. A significant relapse rate is noted: 25–45% within 30 days of initial “remission” and 12–40% with late relapses. Relapses may be more frequent in patients with severe ADAMTS13 deficiency at presentation.

**Hemolytic Uremic Syndrome**

HUS is a syndrome characterized by acute renal failure, microangiopathic hemolytic anemia, and thrombocytopenia. It is seen predominantly in children and in most cases

is preceded by an episode of diarrhea, often hemorrhagic. *Escherichia coli* O157:H7 is the most frequent, although not the only etiologic serotype. HUS not associated with diarrhea (termed *DHUS*) is more heterogeneous in presentation and course. Some children who develop *DHUS* have been found to have mutations in genes encoding factor H, a soluble complement regulator, and membrane cofactor protein that is mainly expressed in the kidney.

### **R<sub>x</sub>** Treatment: **HEMOLYTIC UREMIC SYNDROME**

Treatment of HUS is primarily supportive. In D+HUS, many (~40%) children require at least some period of support with dialysis; however, the overall mortality is <5%. In D-HUS the mortality is higher, ~26%. Plasma infusion or plasma exchange has not been shown to alter the overall course. ADAMTS13 levels are generally reported to be normal in HUS, although occasionally they have been reported to be decreased. As ADAMTS13 assays improve, they may help in defining a subset that better fits a TTP diagnosis and may respond to plasma exchange.

## THROMBOCYTOSIS

Thrombocytosis is almost always due to (1) iron deficiency; (2) inflammation, cancer, or infection (reactive thrombocytosis); or (3) an underlying myeloproliferative process [essential thrombocythemia or polycythemia vera (Chap. 13)] or, rarely, the 5q-myelodysplastic process (Chap. 11). Patients presenting with an elevated platelet count should be evaluated for underlying inflammation or malignancy, and iron deficiency should be ruled out. Thrombocytosis in response to acute or chronic inflammation has not been associated with an increased thrombotic risk. In fact, patients with markedly elevated platelet counts (>1.5 million), usually seen in the setting of a myeloproliferative disorder, have an increased risk of bleeding. This appears to be due, at least in part, to acquired von Willebrand's disease (vWD) due to platelet-vWF adhesion and removal.

## QUALITATIVE DISORDERS OF PLATELET FUNCTION

### *Inherited Disorders of Platelet Function*

Inherited platelet function disorders are thought to be relatively rare, although the prevalence of mild disorders of platelet function is unclear, in part because our testing for such disorders is suboptimal. Rare qualitative disorders include the autosomal recessive disorders Glanzmann's thrombasthenia (absence of the platelet GpIIb/IIIa receptor) and Bernard-Soulier syndrome (absence of the platelet GpIb-IX-V receptor). Both are inherited in an

autosomal recessive fashion and present with bleeding symptoms in childhood.

Platelet storage pool disorder (SPD) is the classic autosomal dominant qualitative platelet disorder. This results from abnormalities of platelet granule formation. It is also seen as a part of inherited disorders of granule formation, such as Hermansky-Pudlak syndrome. Bleeding symptoms in SPD are variable but often mild. The most common inherited disorders of platelet function are disorders that prevent normal secretion of granule content. Few of the abnormalities have been dissected at the molecular level, but these are likely due to multiple abnormalities. They are usually described as *secretion defects*. Bleeding symptoms are usually mild.

### **R<sub>x</sub>** Treatment: **INHERITED DISORDERS OF PLATELET DYSFUNCTION**

Bleeding symptoms or prevention of bleeding in patients with severe dysfunction frequently requires platelet transfusion. Care is taken to limit the risk of alloimmunization by limiting exposure and using prestorage leukodepleted platelets for transfusion. Platelet disorders associated with milder bleeding symptoms frequently respond to desmopressin [1-deamino-8-D-arginine vasopressin (DDAVP)]. DDAVP increases plasma vWF and FVIII levels; whether it also has a direct effect on platelet function is unknown. Particularly for mucosal bleeding symptoms, antifibrinolytic therapy (epsilon-aminocaproic acid or tranexamic acid) is used alone or in conjunction with DDAVP or platelet therapy.

### *Acquired Disorders of Platelet Function*

Acquired platelet dysfunction is common, usually due to medications, either intentionally, as with antiplatelet therapy, or unintentionally, as with high-dose penicillins. Acquired platelet dysfunction occurs in uremia. This is likely multifactorial, but the resultant effect is defective adhesion and activation. The platelet defect is improved most by dialysis but may also be improved by increasing the hematocrit to 27–32%, giving DDAVP (0.3 µg/kg), or use of conjugated estrogens. Platelet dysfunction also occurs with cardiopulmonary bypass due to the effect of the artificial circuit on platelets, and bleeding symptoms respond to platelet transfusion. Platelet dysfunction seen with underlying hematologic disorders can result from nonspecific interference by circulating paraproteins or intrinsic platelet defects in myeloproliferative and myelodysplastic syndromes.

## VON WILLEBRAND'S DISEASE

vWD is the most common inherited bleeding disorder. Estimates from laboratory data suggest a prevalence of



TABLE 18-2

## LABORATORY DIAGNOSIS OF VON WILLEBRAND'S DISEASE

TYPE	aPTT	vWF ANTIGEN	vWF ACTIVITY	FVIII ACTIVITY	MULTIMER
1	NI or ↑	↓	↓	↓	Normal distribution, decreased in quantity
2A	NI or ↑	↓	↓↓	↓	Loss of high and intermediate MW multimers
2B <sup>a</sup>	NI or ↑	↓	↓↓	↓	Loss of high MW multimers
2M	NI or ↑	↓	↓↓	↓	Normal distribution, decreased in quantity
2N	↑↑	NI or ↓ <sup>b</sup>	NI or ↓ <sup>b</sup>	↓↓	Normal distribution
3	↑↑	↓↓	↓↓	↓↓	Absent

<sup>a</sup>Usually also decreased platelet count.

<sup>b</sup>For type 2N, in the homozygous state, FVIII is very low; in the heterozygous state, only seen in conjunction with type 1 vWD.

**Note:** aPTT, activated partial thromboplastin time; vWF, von Willebrand factor; F, factor; NI, normal; MW, molecular weight.

~1%, but data based on symptomatic individuals suggest it is closer to 0.1% of the population. vWF serves two roles: (1) as the major adhesion molecule that tethers the platelet to the exposed subendothelium; and (2) as the binding protein for FVIII, resulting in significant prolongation of the FVIII half-life in circulation. The platelet-adhesive function of vWF critically depends on the presence of large vWF multimers, whereas FVIII binding is not. Most of the symptoms of vWD are “platelet-like” except in more severe vWD when the FVIII is low enough to produce symptoms similar to those found in factor VIII deficiency (hemophilia A).

vWD has been classified into three major types, with four subtypes of type 2 (Table 18-2). By far the most common type of vWD is type 1 disease, with a parallel decrease in vWF protein, vWF function, and FVIII levels, accounting for at least 80% of cases. Patients have predominantly mucosal bleeding symptoms, although postoperative bleeding can also be seen. Bleeding symptoms are very uncommon in infancy and usually manifest later in childhood with excessive bruising and epistaxis. Because these symptoms occur commonly in childhood, the clinician should particularly note bruising at sites unlikely to be traumatized and/or prolonged epistaxis requiring medical attention. Menorrhagia is a common manifestation of vWD. Menstrual bleeding resulting in anemia should warrant an evaluation for vWD and, if negative, functional platelet disorders. Frequently, mild type 1 vWD first manifests with dental extractions, particularly wisdom tooth extraction, or tonsillectomy.

Not all patients with low vWF levels have bleeding symptoms. Whether patients bleed or not depends on the overall hemostatic balance they have inherited, along with environmental influences and the type of hemostatic challenges they experience. Although the inheritance of vWD is autosomal, many factors influence both vWF

levels and bleeding symptoms. These have not all been defined but include blood type, thyroid hormone status, race, stress, exercise, and hormonal (both endogenous and exogenous) influences. Patients with type O blood have vWF protein levels about half those of patients with AB blood type; in fact, the normal range for patients with type O blood overlaps that usually considered diagnostic for vWD. A mildly decreased vWF level should perhaps be viewed more as a risk factor for bleeding than as an actual disease.

Patients with type 2 vWD have functional defects; thus the vWF antigen measurement is significantly higher than the test of function. For types 2A, 2B, and 2M, vWF activity is decreased, measured as ristocetin cofactor or collagen binding activity. In type 2A vWD, the impaired function is due either to increased susceptibility to cleavage by ADAMTS13, resulting in loss of intermediate- and high-molecular weight (MW) multimers, or to decreased secretion of these multimers by the cell. Type 2B vWD results from gain of function mutations that result in increased spontaneous binding of vWF to platelets in circulation, with subsequent clearance of this complex by the reticuloendothelial system. The resulting vWF in the patients' plasma lacks the highest MW multimers, and the platelet count is usually modestly reduced. Type 2M results from a group of mutations that cause dysfunction of the molecule but do not affect multimer structure.

Type 2N vWD reflects mutations in vWF that preclude binding of FVIII. Because FVIII is stabilized by binding to vWF, the FVIII in patients with type 2N vWD has a very short half-life, and the FVIII level is markedly decreased. This is sometimes termed *autosomal hemophilia*. Type 3 vWD, or severe vWD, describes patients with virtually no vWF antigen (usually <10%). Patients experience mucosal and joint postoperative

symptoms as well as other bleeding symptoms. Some patients with type 3 vWD, particularly those with large vWF gene deletions, are at risk of developing antibodies to infused vWF.

Acquired vWD is a rare disorder, most commonly seen in patients with underlying lymphoproliferative disorders, including monoclonal gammopathies of undetermined significance (MGUS), multiple myeloma, and Waldenström's macroglobulinemia. It is seen most commonly in the setting of MGUS and should be suspected in patients, particularly elderly patients, with a new onset of severe mucosal bleeding symptoms.

Heyde's syndrome (aortic stenosis with gastrointestinal bleeding) is attributed to the presence of angiodysplasia of the gastrointestinal tract in patients with aortic stenosis. However, the shear stress on blood passing through the stenotic aortic valve appears to produce a change in vWF, making it susceptible to serum proteases. Consequently, large multimer forms are lost, leading to an acquired type 2 vWD, but return when the stenotic valve is replaced.

### **Rx Treatment:** **VON WILLEBRAND'S DISEASE**

The mainstay of treatment for type 1 vWD is 1-deamino-8-D-arginine vasopressin (DDAVP, or desmopressin), which results in release of vWF and FVIII from endothelial stores. DDAVP can be given intravenously or by an intranasal spray (1.5 mg/mL). The peak activity when given intravenously is ~30 min; it is 2 h when given intranasally. The usual dose is 0.3 µg/kg intravenously or 2 squirts (1 in each nostril) for patients >50 kg (1 squirt for those <50 kg). It is recommended that patients with vWD be tested with DDAVP to assess their response before using it. In patients who respond well (increase in values of two- to fourfold), it can be used for procedures with minor-to-moderate risk of bleeding. Depending on the procedure, additional doses may be needed; it is usually given every 12–24 h. Less frequent dosing may result in less tachyphylaxis, which occurs when synthesis cannot compensate for the released stores. The major side effect of DDAVP is hyponatremia due to decreased free water clearance. This occurs most commonly in the very young and the very old, but fluid restriction should be advised for all patients for the 24 h following each dose.

Some patients with types 2A and 2M vWD respond to DDAVP such that it can be used for minor procedures. For the other subtypes, for type 3 disease, and for major procedures requiring longer periods of normal hemostasis, vWF replacement can be given. Virally inactivated vWF-containing factor concentrates are thought to be safer than cryoprecipitate as the replacement product. Humate-P is the only FDA-approved product for this indication in the United States. Other concen-

trates have been studied in vWD, and a vWF concentrate is available in some countries in Europe.

Antifibrinolytic therapy, using either epsilon-aminocaproic acid or tranexamic acid, is an important therapy, either alone or in an adjunctive capacity, particularly for the prevention or treatment of mucosal bleeding. These agents are particularly useful in prophylaxis for dental procedures, with DDAVP for dental extractions and tonsillectomy, menorrhagia, and prostate procedures. It is contraindicated in the setting of upper urinary tract bleeding, due to the risk of ureteral obstruction.

## **DISORDERS OF THE VESSEL WALL**

The vessel wall is an integral part of hemostasis, and separation of a fluid phase is artificial, particularly in disorders such as TTP or HIT that clearly involve the endothelium as well. Inflammation localized to the vessel wall, such as vasculitis, or inherited connective tissue disorders are abnormalities inherent to the vessel wall.

### **METABOLIC AND INFLAMMATORY DISORDERS**

Acute febrile illnesses may result in vascular damage. This can result from immune complexes containing viral antigens or the viruses themselves. Certain pathogens, such as the rickettsiae causing Rocky Mountain spotted fever, replicate in endothelial cells and damage them. Vascular purpura may occur in patients with polyclonal gammopathies but more commonly in those with monoclonal gammopathies, including Waldenström's macroglobulinemia, multiple myeloma, and cryoglobulinemia. Patients with mixed cryoglobulinemia develop a more extensive maculopapular rash due to immune complex-mediated damage to the vessel wall.

Patients with scurvy (vitamin C deficiency) develop painful episodes of perifollicular skin bleeding as well as more systemic bleeding symptoms. Vitamin C is needed to synthesize hydroxyproline, an essential constituent of collagen. Patients with Cushing's syndrome or on chronic glucocorticoid therapy develop skin bleeding and easy bruising due to atrophy of supporting connective tissue. A similar phenomenon is seen with aging, where, following minor trauma, blood spreads superficially under the epidermis. This has been termed *senile purpura*, and it is most common on skin that has been previously damaged by sun exposure.

Henoch-Schönlein, or anaphylactoid, purpura is a distinct, self-limited type of vasculitis that occurs in children and young adults. Patients have an acute inflammatory reaction with IgA and complement components in capillaries, mesangial tissues, and small arterioles, leading to increased vascular permeability and localized hemorrhage.

234 The syndrome is often preceded by an upper respiratory infection, commonly with streptococcal pharyngitis, or is triggered by drug or food allergies. Patients develop a purpuric rash on the extensor surfaces of the arms and legs, usually accompanied by polyarthralgias or arthritis, abdominal pain, and hematuria from focal glomerulonephritis. All coagulation tests are normal, but renal impairment may occur. Glucocorticoids can provide symptomatic relief but do not alter the course of the illness.

## INHERITED DISORDERS OF THE VESSEL WALL

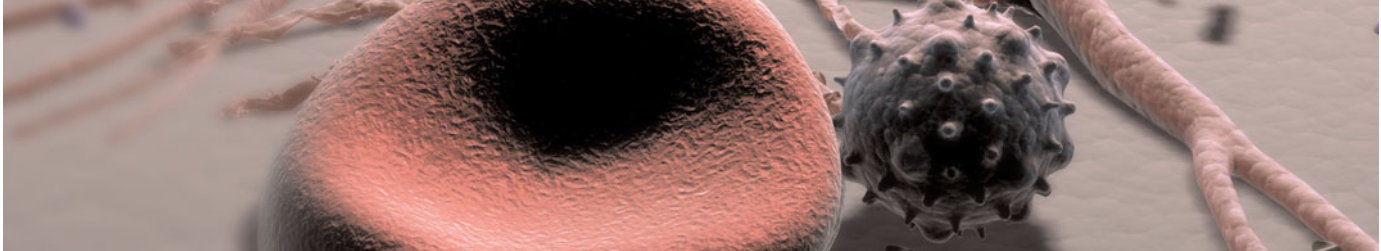
Patients with inherited disorders of the connective tissue matrix, such as Marfan's syndrome, Ehlers-Danlos syndrome, and pseudoxanthoma elasticum, frequently report easy bruising. Inherited vascular abnormalities can result in increased bleeding. This is notably seen in hereditary hemorrhagic telangiectasia (HHT, or Osler-Weber-Rendu disease), a disorder where abnormal telangiectatic capillaries result in frequent bleeding episodes, primarily from the nose and gastrointestinal tract. Arteriovenous malformation (AVM) in the lung, brain, and liver may also occur in HHT. The telangiectasia can often be visualized on the oral and nasal mucosa. Two genes involved in the pathogenesis are *eng* (endoglin) on chromosome 9q33-34 (so-called HHT type 1), associated with pulmonary AVM in 40% of cases; and *alk1* (activin-receptor-like kinase 1) on chromosome 12q13, associated with a much lower risk of pulmonary AVM.

## ACKNOWLEDGMENT

Robert Handin, MD, contributed this chapter in *Harrison's Principles of Internal Medicine, 16e*, and some materials from his chapter are included here.

## FURTHER READINGS

- AREPALLY GM, ORTEL TL: Clinical practice. Heparin-induced thrombocytopenia. *N Engl J Med* 355:809, 2006
- ARMSTRONG E, KONKLE BA: Von Willebrand disease, in *Clinical Hematology*, 1st ed, NS Young et al (eds). Philadelphia, Mosby Elsevier, 2006, pp 830-841
- CINES DB, MCMILLAN R: Management of adult idiopathic thrombocytopenic purpura. *Annu Rev Med* 56:425, 2005
- FEYS HB ET AL: ADAMTS13 in health and disease. *Acta Haematol* 121:183, 2009
- GADISSEUR A et al: Laboratory diagnosis and molecular classification of von Willebrand disease. *Acta Haematol* 121:71, 2009
- GEORGE JN: Clinical practice. Thrombotic thrombocytopenic purpura. *N Engl J Med* 354:1927, 2006
- IPEMA HJ et al: Romiplostim management of immune thrombocytopenic purpura. *Ann Pharmacother* 43:914, 2009
- MICHELIS JJ et al: Managing patients with von Willebrand disease type 1, 2, and 3 with desmopressin and von Willebrand factor-factor VIII concentrate in surgical settings. *Acta Haematol* 121:167, 2009
- RAO AK et al: Inherited defects in platelet signaling mechanisms. *Semin Thromb Hemost* 30:525, 2004
- RAUOVA L et al: Platelet and monocyte antigenic complexes in the pathogenesis of heparin-induced thrombocytopenia (HIT). *J Thromb Haemost* 7 (suppl 1):249, 2009
- SADLER JE: New concepts in von Willebrand disease. *Annu Rev Med* 56:173, 2005
- WARKENTIN TE: Heparin-induced thrombocytopenia. *Disease-A-Month* 51:141, 2005



## CHAPTER 19

# COAGULATION DISORDERS

Valder Arruda ■ Katherine A. High

■ Hemophilia . . . . .	236
Pathogenesis and Clinical Manifestations . . . . .	236
Factor XI Deficiency . . . . .	239
■ Other Rare Bleeding Disorders . . . . .	239
Familial Multiple Coagulation Deficiencies . . . . .	240
Disseminated Intravascular Coagulation . . . . .	240
Vitamin K Deficiency . . . . .	243
Coagulation Disorders Associated with Liver Failure . . . . .	243
Acquired Inhibitors of Coagulation Factors . . . . .	244
■ Further Readings . . . . .	244

Deficiencies of coagulation factors have been recognized for centuries. Patients with genetic deficiencies of plasma coagulation factors exhibit lifelong recurrent bleeding episodes into joints, muscles, and closed spaces, either spontaneously or following an injury. The most common inherited factor deficiencies are the hemophilias, X-linked diseases caused by deficiency of factor (F) VIII (hemophilia A) or factor IX (FIX, hemophilia B). Rare congenital bleeding disorders due to deficiencies of other factors, including FII (prothrombin), FV, FVII, FX, FXI, FXIII, and fibrinogen are usually inherited in an autosomal recessive manner (Table 19-1). Advances in characterization of the molecular bases of clotting factor deficiencies have contributed to a better understanding of the disease phenotypes and may allow more targeted therapeutic approaches through the development of small molecules, recombinant proteins, or cell- and gene-based therapies.

Commonly used tests of hemostasis provide the initial screening for clotting factor activity (Fig. 19-1), and disease phenotype often correlates with the level of clotting activity. An isolated abnormal prothrombin time (PT) suggests FVII deficiency, whereas a prolonged activated partial thromboplastin time (aPTT) indicates most commonly hemophilia or FXI deficiency (Fig. 19-1).

The prolongation of both PT and aPTT suggests deficiency of FV, FX, FII, or fibrinogen abnormalities. The addition of the missing factor to the subject's plasma at a range of doses corrects the abnormal clotting times; the result is expressed as a percentage of the activity observed in normal subjects.

Acquired deficiencies of plasma coagulation are more frequent than congenital disorders; the most common disorders include hemorrhagic diathesis of liver disease, disseminated intravascular coagulation (DIC), and vitamin K deficiency. In these disorders, blood coagulation is hampered by the deficiency of more than one clotting factor, and the bleeding episodes result from perturbation of both primary (e.g., platelet and vessel wall interactions) and secondary (coagulation) hemostasis.

The development of antibodies to coagulation plasma proteins, clinically termed *inhibitors*, is a relatively rare problem that most often affects hemophilia A or B and FXI-deficient patients who receive repeated doses of the missing protein to control bleeding episodes. Inhibitors also occur among subjects without genetic deficiency of clotting factors—e.g., in the postpartum setting, as a manifestation of underlying autoimmune or neoplastic disease, or idiopathically. Rare cases of inhibitors to thrombin or FV have been reported in patients receiving

## GENETIC AND LABORATORY CHARACTERISTICS OF INHERITED COAGULATION DISORDERS

CLOTTING FACTOR DEFICIENCY	INHERITANCE	PREVALENCE IN GENERAL POPULATION	LABORATORY ABNORMALITY <sup>a</sup>			MINIMUM HEMOSTATIC LEVELS	TREATMENT	PLASMA HALF-LIFE
			aPTT	PT	TT			
Fibrinogen	AR	1 in 1,000,000	+	+	+	100 mg/dL	Cryoprecipitate	2–4 d
Prothrombin	AR	1 in 2,000,000	+	+	–	20–30%	FFP/PCCs	3–4 d
Factor V	AR	1 in 1,000,000	+/-	+/-	–	15–20%	FFP	36 h
Factor VII	AR	1 in 500,000	–	+	–	15–20%	FFP/PCCs	4–6 h
Factor VIII	X-linked	1 in 5,000	+	–	–	30%	FVIII concentrates	8–12 h
Factor IX	X-linked	1 in 30,000	+	–	–	30%	FIX concentrates	18–24 h
Factor X	AR	1 in 1,000,000	+/-	+/-	–	15–20%	FFP/PCCs	40–60 h
Factor XI	AR	1 in 1,000,000	+	–	–	15–20%	FFP	40–70 h
Factor XII	AR	ND	+	–	–	<sup>b</sup>	<sup>b</sup>	60 h
HK	AR	ND	+	–	–	<sup>b</sup>	<sup>b</sup>	150 h
Prekallikrein	AR	ND	+	–	–	<sup>b</sup>	<sup>b</sup>	35 h
Factor XIII	AR	1 in 2,000,000	–	–	+/-	2–5%	Cryoprecipitate	11–14 d

<sup>a</sup>Values within normal range (–) or prolonged (+).

<sup>b</sup>No risk for bleeding; treatment is not indicated.

**Note:** HK, high-molecular-weight kininogen; AR, autosomal recessive; aPTT, activated partial thromboplastin time; PT, prothrombin time; TT, thrombin time; ND, not determined; FFP, fresh-frozen plasma; PCCs, prothrombin complex concentrates.

topical bovine thrombin preparation as a local hemostatic agent in complex surgeries. The diagnosis of inhibitors is based on the same tests as those used to diagnose inherited plasma coagulation factor deficiencies. However, the addition of the missing protein to the plasma of a subject with an inhibitor does not correct the abnormal aPTT and/or PT tests. This is the major laboratory difference between deficiencies and inhibitors. Additional tests are required to measure the specificity of the inhibitor and its titer.

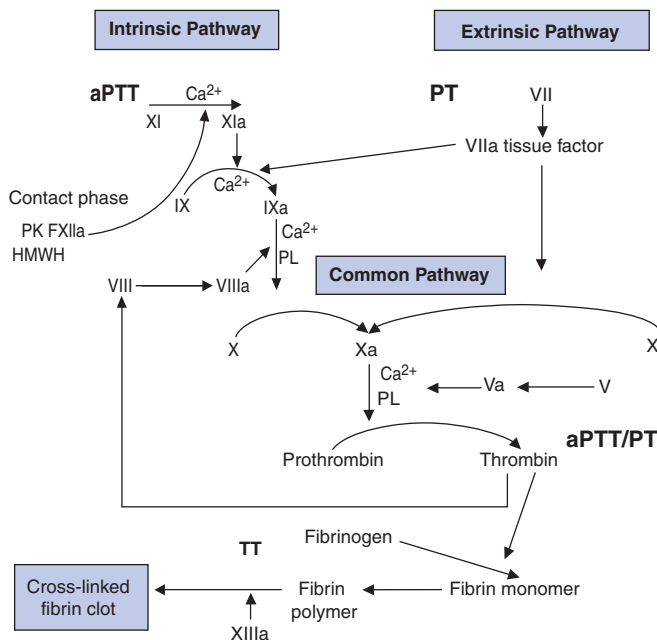
The treatment of these bleeding disorders often requires replacement of the deficient protein using recombinant or purified plasma-derived products or fresh-frozen plasma. Therefore, it is imperative to arrive at a proper diagnosis to optimize patient care without unnecessary exposure to the risks of bloodborne disease.

## HEMOPHILIA

### PATHOGENESIS AND CLINICAL MANIFESTATIONS

Hemophilia is an X-linked recessive hemorrhagic disease due to mutations in the *F8* gene (hemophilia A or classic hemophilia) or *F9* gene (hemophilia B). The disease affects 1 in 10,000 males worldwide, in all ethnic groups; hemophilia A represents 80% of all cases. Male subjects are clinically affected; women, who carry a single mutated gene, are generally asymptomatic. Family history of the disease is absent in ~30% of cases. In these cases, 80% of the mothers are carriers of the de novo mutated allele. More than 500 different mutations have been identified in the *F8* or *F9* genes. One of the most common hemophilia A mutations results from an inversion of the intron 22 sequence, which is present in 40% of cases of severe hemophilia A. Advances in molecular diagnosis now permit precise identification of mutations, allowing accurate diagnosis of women carriers of the hemophilia gene in affected families.

Clinically, hemophilia A and hemophilia B are indistinguishable. The disease phenotype correlates with the residual activity of FVIII or FIX and can be classified as severe (<1%), moderate (1–5%), or mild (6–30%). In the severe and moderate forms, the disease is characterized



**FIGURE 19-1**

**Coagulation cascade and laboratory assessment of clotting factor deficiency** by activated partial prothrombin time (aPTT), prothrombin time (PT), and thrombin time (TT).

by bleeding episodes into the joints (hemarthroses), soft tissues, and muscles after minor trauma or even spontaneously. Patients with mild disease experience infrequent bleeding that is usually secondary to trauma. Among those with residual FVIII or FIX activity >25% of normal, the disease is discovered only by bleeding after major trauma or during routine presurgery laboratory tests. Typically, the global tests of coagulation show only an isolated prolongation of the aPTT assay. Patients with hemophilia have normal bleeding times and platelet counts. The diagnosis is made after specific determination of FVIII or FIX clotting activity.

Early in life, bleeding may present after circumcision or rarely as intracranial hemorrhages. The disease is more evident when children begin to walk or crawl. In the severe form, the most common bleeding manifestations are the recurrent hemarthroses, which can affect every joint but mainly affect knees, elbows, ankles, shoulders, and hips. Acute hemarthroses are painful, and clinical signs are local swelling and erythema. To avoid pain, the patient may adopt a fixed position, which leads eventually to muscle contractures. Very young children unable to communicate verbally show irritability and a lack of movement of the affected joint. Chronic hemarthroses are debilitating, with synovial thickening and synovitis in response to the intraarticular blood. After a joint has been damaged, recurrent bleeding episodes result in the clinically recognized “target joint,” which then establishes a vicious cycle of bleeding, resulting in progressive joint deformity that in critical cases requires surgery as the only therapeutic option. Hematomas into the muscle of distal parts of the limbs may lead to external compression of arteries, veins, or nerves, which can evolve to a compartment syndrome.

Bleeding into the oropharyngeal spaces, central nervous system, or the retroperitoneum is life-threatening and requires immediate therapy. Retroperitoneal hemorrhages can accumulate large quantities of blood along with formation of masses with calcification and inflammatory tissue reaction (pseudotumor syndrome), and they can also result in damage to the femoral nerve. Pseudotumors can also form in bones, especially long bones of the lower limbs. Hematuria is frequent among hemophilia patients, even in the absence of genitourinary pathology. It is often self-limited and may not require specific therapy.

### **Rx Treatment: HEMOPHILIA**

Without treatment, patients with severe hemophilia have a limited life expectancy. Advances in the blood fractionation industry during World War II resulted in the realization that plasma could be used to treat hemophilia, but the volumes required to achieve even modest elevation of circulating factor levels limits the utility of plasma infusion as an approach to disease management. The

discovery in the 1960s that cryoprecipitate fraction of plasma was enriched for FVIII, in addition to the eventual purification of FVIII and FIX from plasma, led to the introduction of home infusion therapy with factor concentrates in the 1970s. The availability of factor concentrates resulted in a dramatic improvement in life expectancy and in quality of life for people with severe hemophilia. However, the contamination of the blood supply with hepatitis viruses and, subsequently, HIV resulted in widespread transmission of these blood-borne infections within the hemophilia population; complications of HIV and of hepatitis C are now the leading causes of death among U.S. adults with severe hemophilia. The introduction of viral inactivation steps in the preparation of plasma-derived products in the mid-1980s greatly reduced the risk of HIV and hepatitis, and the risks were further reduced by the successful production of recombinant FVIII and FIX proteins, both licensed in the 1990s. It is uncommon for hemophilic patients born after 1985 to have contracted either hepatitis or HIV, and for these individuals, life expectancy is in the range of 65 years of age.

Factor replacement therapy for hemophilia can be provided either in response to a bleeding episode or as a prophylactic treatment. Primary prophylaxis is defined as a strategy for maintaining the missing clotting factor at levels ~1% or higher on a regular basis to prevent bleeds, especially the onset of hemarthroses. Hemophilic boys receiving regular infusions of FVIII (3 days/week) or FIX (2 days/week) can reach puberty without detectable joint abnormalities. Although highly recommended, this regimen is performed for <30% of patients because of the high cost, difficulties in accessing peripheral veins in young patients, and the potential infectious and thrombotic risks of long-term central vein catheters.

General considerations regarding the treatment of bleeds in hemophilia include (1) the need to begin the treatment as soon as possible because symptoms often precede objective evidence of bleeding; because of the superior efficacy of early therapeutic intervention, classic symptoms of bleeding into the joint in a reliable patient, headaches, or automobile or other accidents, require prompt replacement and further laboratory investigation; and (2) the need to avoid drugs that hamper platelet function such as aspirin or aspirin-containing drugs; to control pain, drugs such as ibuprofen or propoxyphene are preferred.

Factor VIII and factor IX are dosed in units. One unit is by definition the amount of FVIII (100 ng/mL) or FIX (5 µg/mL) in 1 mL of normal plasma. One unit of FVIII per kilogram of body weight increases the plasma FVIII level by 2%. One can calculate the dose needed to increase FVIII levels to 100% in a 70-kg severe hemophilia patient (<1%) using the simple formula below. Thus 3500 units of FVIII will raise the circulating level to 100%.

$$\text{FVIII dose (IU)} = \text{Target FVIII levels} - \text{FVIII baseline levels} \times \text{body weight (kg)} \times 0.5 \text{ unit/kg}$$

The doses for FIX replacement are different from those for FVIII because FIX recovery postinfusion is usually only 50% of the predicted value. Therefore, the formula for FIX replacement is

$$\text{FIX dose (IU)} = \text{Target FIX levels} - \text{FIX baseline levels} \times \text{body weight (kg)} \times 1.0 \text{ unit/kg}$$

The FVIII half-life of 8–12 h requires injections twice a day to maintain therapeutic levels, whereas the FIX half-life is longer, ~24 h, so that once-a-day injection is sufficient. In specific situations such as postsurgery, continuous infusion of factor may be desirable because of its safety in achieving sustained factor levels at a lower total cost.

Cryoprecipitate is enriched with FVIII protein (each bag contains ~80 IU of FVIII) and was commonly used for the treatment of hemophilia A decades ago; it is still in use in some developing countries, but because of the risk of bloodborne diseases, this product should be avoided in hemophilia patients when factor concentrates are available.

Mild bleeds such as uncomplicated hemarthroses or superficial hematomas require initial therapy with factor levels of 30–50%. Additional doses to maintain levels of 15–25% for 2 or 3 days are indicated for severe hemarthroses, especially when these episodes affect the “target joint.” Large hematomas, or bleeds into deep muscles, require factor levels of 50% or even higher if the clinical symptoms do not improve, and factor replacement may be required for a period of  $\geq 1$  week. The control of serious bleeds, including those that affect the oropharyngeal spaces, central nervous system, and the retroperitoneum, require sustained protein levels of 50–100% for 7–10 days. Prophylactic replacement for surgery is aimed at achieving normal factor levels (100%) for a period of 7–10 days; replacement can then be tapered depending on the extent of the surgical wounds. Oral surgery is associated with extensive tissue damage, which usually requires factor replacement for 1–3 days coupled with oral antifibrinolytic drugs.

## NONTRANSFUSION THERAPY IN HEMOPHILIA

**DDAVP (1-deamino-8-D-arginine vasopressin)** DDAVP is a synthetic vasopressin analogue that causes a transient rise in FVIII and von Willebrand’s factor (vWF), but not FIX, through a mechanism involving release from endothelial cells. Patients with moderate or mild hemophilia A should be tested to determine if they respond to DDAVP before a therapeutic application. DDAVP at doses of 0.3  $\mu\text{g/kg}$  body weight infused over a 20-min period is expected to raise FVIII levels by two- to threefold over baseline, peaking between 30–60 min postinfusion. DDAVP does not improve FVIII levels in severe

hemophilia A patients because there are no stores to release. Repeated dosing of DDAVP results in tachyphylaxis because the mechanism is an increase in release rather than de novo synthesis of FVIII and vWF. More than three consecutive doses become ineffective and if further therapy is indicated, FVIII replacement is required to achieve hemostasis.

**Antifibrinolytic Drugs** Bleeding in the gums, in the gastrointestinal tract, and during oral surgery requires the use of oral antifibrinolytic drugs such as  $\epsilon$ -aminocaproic acid (EACA) or tranexamic acid to control local hemostasis. The duration of the treatment depending on the clinical indication is  $\geq 1$  week. Tranexamic acid is given at doses of 25 mg/kg three to four times a day. EACA treatment requires a loading dose of 200 mg/kg (maximum of 10 g) followed by 100 mg/kg (maximum 30 g/d) every 6 h. These drugs are not indicated to control hematuria because of the risk of formation of an occlusive clot in the lumen of genitourinary tract structures.

## COMPLICATIONS

**Inhibitor Formation** The formation of alloantibodies to FVIII or FIX is currently the major complication of hemophilia treatment. The prevalence of inhibitors to FVIII is estimated at 5–10% of all cases and ~20% of severe hemophilia A patients. Inhibitors to FIX are detected in only 3–5% of all hemophilia B patients. The high-risk group for inhibitor formation includes severe deficiency (>80% of all cases of inhibitors), familial history of inhibitors, African descent, mutations in the FVIII or FIX gene resulting in deletion of large coding regions, or gross gene rearrangements. Inhibitors usually appear early in life, at a median of 2 years of age, and after 10 cumulative days of exposure.

The clinical diagnosis of inhibitor is suspected when patients do not respond to factor replacement at therapeutic doses. Inhibitors increase both morbidity and mortality in hemophilia. Because early detection of an inhibitor is critical to a successful correction of the bleeding or to eradication of the antibody, most hemophilia centers perform annual screening for inhibitors. The laboratory test required to confirm the presence of an inhibitor is an aPTT mixed with normal plasma. In most hemophilia patients, a 1:1 mix with normal plasma completely corrects the aPTT. In inhibitor patients, the aPTT on a 1:1 mix is abnormally prolonged because the inhibitor neutralizes the FVIII clotting activity of the normal plasma. The Bethesda assay uses a similar principle and defines the specificity of the inhibitor and its titer. The results are expressed in Bethesda units (BU), in which 1 BU is the amount of antibody that neutralizes 50% of the FVIII or FIX present in normal plasma after 2 h of incubation at 37°C. Clinically, inhibitor patients are classified as low responders or high responders, which provides guidelines for optimal therapy. Therapy for inhibitor

patients has two goals: the control of acute bleeding episodes and the eradication of the inhibitor. For the control of bleeding episodes, low responders, those with titers <5 BU, respond well to high doses of human or porcine FVIII (50–100 U/kg) with minimal or no increase in the inhibitor titers. However, high-responder patients—those with initial inhibitor titer >10 BU or an anamnestic response in the antibody titer to >10 BU even if low titer initially—do not respond to FVIII or FIX concentrates. The control of bleeding episodes in high-responder patients can be achieved by using concentrates enriched for prothrombin, FVII, FIX, FX [prothrombin complex concentrates (PCCs) or activated PCCs], and more recently by recombinant activated Factor VII (FVIIa) (Fig. 19-1). The rates of therapeutic success have been higher for FVIIa than for PCC or aPCC. For eradication of the inhibitory antibody, immunosuppression is not effective. The most effective strategy is immune tolerance induction (ITI) based on daily infusion of the missing protein until the inhibitor disappears, typically requiring periods >1 year, with success rates in the range of 60%. Promising results have been obtained by adding anti-CD20 monoclonal antibody (rituximab) as a coadjuvant for the eradication of high levels of antibody in patients undergoing ITI.

**Infectious Diseases** Hepatitis C virus (HCV) infection is the major cause of morbidity and the second leading cause of death in hemophilia patients exposed to older clotting factor concentrates. The vast majority of young patients treated with plasma-derived products from 1970 to 1985 became infected with HCV. It has been estimated that >80% of patients >20 years of age were HCV antibody positive as of 2006. The comorbidity of the underlying liver disease in hemophilia patients is clear when these individuals require invasive procedures; correction of both genetic and acquired (secondary to liver disease) deficiencies may be needed. Infection with HIV also swept the population of patients treated with plasma-derived concentrates two decades ago. Coinfection of HCV and HIV, present in almost 50% of hemophilia patients, is an aggravating factor for the evolution of liver disease. The response to HCV antiviral therapy in hemophilia is restricted to <30% of patients and is even poorer among those with both HCV and HIV infection. End-stage liver disease requiring organ transplantation may be curative for both the liver disease and for hemophilia.

## FACTOR XI DEFICIENCY

Factor XI is a zymogen of an active serine protease (FXIa) in the intrinsic pathway of blood coagulation that activates FIX (Fig. 19-1). There are two pathways for the formation of FXIa. In an aPTT-based assay, the protease is the result of activation by FXIIa in conjunction with high-molecular-weight kininogen and kallikrein. Thrombin appears to be

the physiologic activator of FXI. The generation of thrombin by the tissue-factor/factor VIIa pathway activates FXI on the platelet surface, which contributes to additional thrombin generation after the clot has formed and thus augments resistance to fibrinolysis through a thrombin-activated fibrinolytic inhibitor (TAFI).

Factor XI deficiency is a rare bleeding disorder that occurs in the general population at a frequency of one in a million. However, the disease is highly prevalent among Ashkenazi and Iraqi Jewish populations, reaching a frequency of 6% as heterozygotes and 0.1–0.3% as homozygotes. More than 65 mutations in the *FXI* gene have been reported, whereas two to three mutations are found among affected Jewish populations.

Normal FXI clotting activity levels range from 70 to 150 U/dL. In heterozygous patients with moderate deficiency, FXI ranges from 20 to 70 U/dL, whereas in homozygous or double heterozygote patients, FXI levels are <1–20 U/dL. Patients with FXI levels <10% of normal have a high risk of bleeding, but the disease phenotype does not always correlate with residual FXI clotting activity. A family history is indicative of the risk of bleeding in the propositus. Clinically, the presence of mucocutaneous hemorrhages such as bruises, gum bleeding, epistaxis, hematuria, and menorrhagia are common, especially following trauma. This hemorrhagic phenotype suggests that tissues rich in fibrinolytic activity are more susceptible to FXI deficiency. Postoperative bleeding is common but not always present, even among patients with very low FXI levels.

### **Rx** Treatment: FACTOR XI DEFICIENCY

The treatment of FXI deficiency is based on the infusion of FFP at doses of 15–20 mL/kg to maintain trough levels ranging from 10–20%. Because FXI has a half-life of 40–70 h, the replacement therapy can be given on alternate days. The use of antifibrinolytic drugs is beneficial to control bleeds, with the exception of hematuria or bleeds in the bladder. The development of a FXI inhibitor was observed in 10% of severely FXI-deficient patients who received replacement therapy.

## OTHER RARE BLEEDING DISORDERS

Collectively, the inherited disorders resulting from deficiencies of clotting factors other than FVIII, FIX, and FXI (Table 19-1) represent a group of rare bleeding diseases. The bleeding symptoms in these patients vary from asymptomatic (dysfibrinogenemia or FVII deficiency) to life-threatening (FX or FXIII deficiency). There is no pathognomonic clinical manifestation that suggests one specific disease, but overall, in contrast to



240 hemophilia, hemarthrosis is a rare event, and bleeding in the mucosal tract or after umbilical cord clamping is common. Individuals heterozygous for plasma coagulation deficiencies are often asymptomatic. The laboratory assessment for the specific deficient factor following screening with general coagulation tests (Table 19-1) will establish the diagnosis.

Replacement therapy using fresh-frozen plasma (FFP) or PCCs (containing prothrombin, FVII, FIX, and FX) provides adequate hemostasis in response to bleeds or as prophylactic treatment. The use of PCCs should be carefully monitored and avoided in patients with underlying liver disease or those at high risk for thrombosis because of the risk of DIC.

## FAMILIAL MULTIPLE COAGULATION DEFICIENCIES

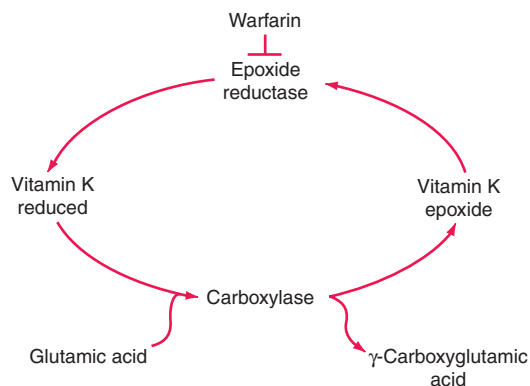
Several bleeding disorders are characterized by the inherited deficiency of more than one plasma coagulation factor. To date, the genetic defects in two of these diseases have been characterized, and they provide new insights into the regulation of hemostasis by genes encoding proteins outside blood coagulation.

### Combined Deficiency of FV and FVIII

Patients with combined FV and FVIII deficiency exhibit ~5% of residual clotting activity of each factor. Interestingly, the disease phenotype is a mild bleeding tendency, often following trauma. An underlying mutation has been identified in the endoplasmic reticulum/Golgi intermediate compartment (ERGIC-53) gene, a mannose-binding protein localized in the Golgi apparatus that functions as a chaperone for both FV and FVIII. In other families, mutations in the multiple coagulation factor deficiency 2 (MCFD2) gene have been defined; this gene encodes a protein that forms a  $\text{Ca}^{2+}$ -dependent complex with ERGIC-53 and provides cofactor activity in the intracellular mobilization of both FV and FVIII.

### Multiple Deficiencies of Vitamin K-Dependent Coagulation Factors

Two enzymes involved in vitamin K metabolism have been associated with combined deficiency of all vitamin K-dependent proteins, including the procoagulant proteins prothrombin, VII, IX, and X and the anticoagulants protein C and protein S. Vitamin K is a fat-soluble vitamin that is a cofactor for carboxylation of the gamma carbon of the glutamic acid residues in the vitamin K-dependent factors, a critical step for calcium and phospholipid binding of these proteins (Fig. 19-2). The enzymes  $\gamma$ -glutamylcarboxylase and epoxide reductase are critical for the metabolism and regeneration of vitamin K. Mutations in the genes encoding the gamma-carboxylase



**FIGURE 19-2**

**The vitamin K cycle.** Vitamin K is a cofactor for the formation of  $\gamma$ -carboxyglutamic acid residues on coagulation proteins. Vitamin K-dependent  $\gamma$ -glutamylcarboxylase, the enzyme that catalyzes the vitamin K epoxide reductase, regenerates reduced vitamin K. Warfarin blocks the action of the reductase and competitively inhibits the effects of vitamin K.

(GGCX) or vitamin K epoxide reductase complex 1 (VKORC1) result in defective enzymes and thus in vitamin K-dependent factors with reduced activity, varying from 1–30% of normal. The disease phenotype is characterized by mild to severe bleeding episodes present from birth. Some patients respond to high doses of vitamin K. For severe bleeding, replacement therapy with FFP or PCCs may be necessary for achieving full hemostatic control.

## DISSEMINATED INTRAVASCULAR COAGULATION

DIC is a clinicopathologic syndrome characterized by widespread intravascular fibrin formation in response to excessive blood protease activity that overcomes the natural anticoagulant mechanisms. DIC is associated with several underlying pathologies (Table 19-2). The most common causes are bacterial sepsis, malignant disorders such as solid tumors or acute promyelocytic leukemia (APL), and obstetric causes. DIC is diagnosed in almost half of pregnant women with abruptio placentae or with amniotic fluid embolism. Trauma, particularly to the brain, can also result in DIC. The exposure of blood to phospholipids from damaged tissue, hemolysis, and endothelial damage are all contributing factors to the development of DIC in this setting. Purpura fulminans is a severe form of DIC resulting from thrombosis of extensive areas of the skin; it affects predominantly young children following viral or bacterial infection, particularly those with inherited or acquired hypercoagulability due to deficiencies of the components of the protein C pathway. Neonates homozygous for protein C deficiency also present high risk for purpura fulminans, with or without thrombosis of large vessels.

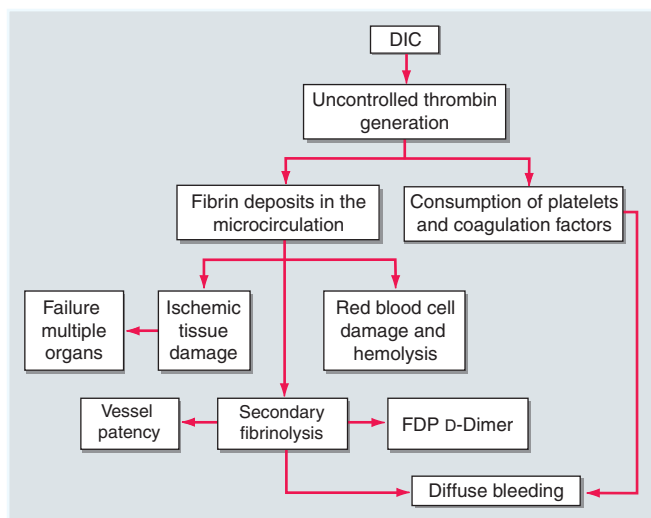
TABLE 19-2

COMMON CLINICAL CAUSES OF DISSEMINATED INTRAVASCULAR COAGULATION	
<b>Sepsis</b> Bacterial Staphylococci, streptococci, pneumococci, meningococci, gram-negative bacilli Viral Mycotic Parasitic Rickettsial	<b>Immunologic disorders</b> Acute hemolytic transfusion reaction Organ or tissue transplant rejection Graft-versus-host disease
<b>Trauma and tissue injury</b> Brain injury (gunshot) Extensive burns Fat embolism Rhabdomyolysis	<b>Drugs</b> Fibrinolytic agents Aprotinin Warfarin (especially in neonates with protein C deficiency) Prothrombin complex concentrates Recreational drugs (amphetamines)
<b>Vascular disorders</b> Giant hemangiomas (Kasabach-Merritt syndrome) Large vessel aneurysms (e.g., aorta)	<b>Envenomation</b> Snake Insects
<b>Obstetric complications</b> Abruptio placentae Amniotic fluid embolism Dead fetus syndrome Septic abortion	<b>Liver disease</b> Fulminant hepatic failure Cirrhosis Fatty liver of pregnancy
<b>Cancer</b> Adenocarcinoma (prostate, pancreas, etc) Hematologic malignancies (acute promyelocytic leukemia)	<b>Miscellaneous</b> Shock Respiratory distress syndrome Massive transfusion

The central mechanism of DIC is the uncontrolled generation of thrombin by exposure of the blood to pathologic levels of tissue factor (Fig. 19-3). Simultaneous suppression of physiologic anticoagulant mechanisms and abnormal fibrinolysis further accelerate the process. Together these abnormalities contribute to systemic fibrin deposition in small and mid-sized vessels. The duration and intensity of the fibrin deposition can compromise the blood supply of many organs, especially the lung, kidney, liver, and brain, with consequent organ failure. The sustained activation of coagulation results in consumption of clotting factors and platelets, which in turn leads to systemic bleeding. This is further aggravated by secondary hyperfibrinolysis. Studies in animals demonstrate that the fibrinolytic system is indeed suppressed at the time of maximal activation of coagulation. Interestingly, in patients with APL, a severe hyperfibrinolytic state often occurs in addition to the coagulation activation. The release of several proinflammatory cytokines such as interleukin 6 and tumor necrosis factor  $\alpha$  play central roles in mediating the coagulation defects in DIC and symptoms associated with systemic inflammatory response syndrome.

Clinical manifestations of DIC are related to the magnitude of the imbalance of hemostasis, to the underlying disease, or to both. The most common findings are bleeding

ranging from oozing from venipuncture sites, petechiae, and ecchymoses to severe hemorrhage from the gastrointestinal tract or lung or into the central nervous system. In chronic DIC the bleeding symptoms are discreet and



**FIGURE 19-3** The pathophysiology of disseminated intravascular coagulation (DIC). Interactions between coagulation and fibrinolytic pathways result in bleeding and thrombosis in the microcirculation in patients with DIC.

242 restricted to skin or mucosal surfaces. The hypercoagulability of DIC manifests as the occlusion of vessels in the microcirculation and resulting organ failure. Thrombosis of large vessels and cerebral embolism can also occur. Hemodynamic complications and shock are common among patients with acute DIC. The mortality ranges from 30 to >80% depending on the underlying disease, the severity of the DIC, and the age of the patient.

The diagnosis of clinically significant DIC is based on the presence of clinical and/or laboratory abnormalities of coagulation or thrombocytopenia. The laboratory diagnosis of DIC should prompt a search for the underlying disease if it is not already apparent. No single test establishes the diagnosis of DIC. The laboratory investigation should include coagulation tests [aPTT, PT, thrombin time (TT)] and markers of fibrin degradation products (FDP), in addition to platelet and red cell count and analysis of the blood smear. These tests should be repeated over a period of 6–8 h because an initially mild abnormality can change dramatically in patients with severe DIC.

Common findings include the prolongation of PT and/or aPTT; platelet counts  $\leq 100,000/\text{mm}^3$ , or a rapid decline in platelet numbers; the presence of schistocytes (fragmented red cells) in the blood smear; and elevated levels of FDP. The most sensitive test for DIC is the FDP level. DIC is an unlikely diagnosis in the presence of normal levels of FDP. The D-dimer test is more specific for detection of fibrin (but not fibrinogen) degradation products and indicates that the cross-linked fibrin has been digested by plasmin. Because fibrinogen has a prolonged half-life, plasma levels diminish acutely only in severe cases of DIC. High-grade DIC is also associated with levels of antithrombin III or plasminogen activity <60% of normal.

### Chronic DIC

Low-grade, compensated DIC can occur in certain clinical situations, including giant hemangioma, metastatic carcinoma, or the dead fetus syndrome. Plasma levels of FDP or D-dimers are elevated. aPTT, PT, and fibrinogen values are within the normal range or high. Mild thrombocytopenia or normal platelet counts are also common findings. Red cell fragmentation is often detected but at a lower degree than in acute DIC.

### Differential Diagnosis

The differential diagnosis between DIC and severe liver disease is challenging and requires serial measurements of the laboratory parameters of DIC. Patients with severe liver disease are at risk for bleeding and manifest laboratory features including thrombocytopenia (due to platelet sequestration, portal hypertension, or hypersplenism), decreased synthesis of coagulation factors and natural

anticoagulants, and elevated levels of FDP due to reduced hepatic clearance. However, in contrast to DIC, these laboratory parameters in liver disease do not change rapidly. Other important differential findings include the presence of portal hypertension or other clinical or laboratory evidence of underlying liver disease.

Microangiopathic disorders such as thrombotic thrombocytopenic purpura present an acute clinical onset of illness accompanied by thrombocytopenia, red cell fragmentation, and multiorgan failure. There is, however, no consumption of clotting factors or hyperfibrinolysis.

### **Rx** Treatment: **DISSEMINATED INTRAVASCULAR COAGULATION**

The morbidity and mortality associated with DIC are primarily related to the underlying disease rather than the complications of the DIC. The control or elimination of the underlying cause should therefore be the primary concern. Patients with severe DIC require control of hemodynamic parameters, respiratory support, and sometimes invasive surgical procedures. Attempts to treat DIC without accompanying treatment of the causative disease are likely to fail.

### **MANAGEMENT OF HEMORRHAGIC SYMPTOMS**

The control of bleeding in DIC patients with marked thrombocytopenia (platelet counts  $<10,000\text{--}20,000/\text{mm}^3$ ) and low levels of coagulation factors require replacement therapy. The PT ( $>1.5 \times$  normal) provides a good indicator of the severity of the clotting factor consumption. Replacement with FFP is indicated (1 unit of FFP increases most coagulation factors by 3% in an adult without DIC). Low levels of fibrinogen ( $<100$  mg/dL) or brisk hyperfibrinolysis require infusion of cryoprecipitate (plasma fraction enriched for fibrinogen, FVIII, and vWF). The replacement of 10 U of cryoprecipitate for every 2–3 U of FFP is sufficient to correct the hemostasis. The transfusion scheme must be adjusted according to the patient's clinical and laboratory evolution. Platelet concentrates at a dose of 1–2 U/10 kg body weight are sufficient for most DIC patients with severe thrombocytopenia.

Clotting factor concentrates are not recommended for control of bleeding in DIC because of the limited efficacy afforded by replacement of single factors (factor VIII or IX concentrates) and the high risk of products containing traces of activated blood proteases (PCCs), which further aggravates the disease.

### **REPLACEMENT OF COAGULATION OR FIBRINOLYSIS INHIBITORS**

Drugs to control coagulation such as heparin, antithrombin III (ATIII) concentrates, or antifibrinolytic drugs have all been tried in

the treatment of DIC. Low doses of continuous infusion heparin (5–10 U/kg per hour) may be effective in patients with low-grade DIC associated with solid tumor or APL or in a setting with recognized thrombosis. Heparin is also indicated for the treatment of purpura fulminans, during the surgical resection of giant hemangiomas, and during removal of a dead fetus. In acute DIC, the use of heparin is likely to aggravate bleeding. To date, the use of heparin in severe DIC patients is of no proven survival benefit.

The use of antifibrinolytic drugs, EACA, or tranexamic acid to prevent fibrin degradation by plasmin may reduce bleeding episodes in patients with DIC and confirmed hyperfibrinolysis. However, these drugs can increase the risk of thrombosis, and concomitant use of heparin is indicated. Patients with APL or those with chronic DIC associated with giant hemangiomas are among the few patients who may benefit from this therapy.

The use of protein C concentrates to treat purpura fulminans associated with acquired protein C deficiency or meningococemia has been proved effective. The results from the replacement of ATIII in early phase studies are promising but require further study.

## VITAMIN K DEFICIENCY

Vitamin K–dependent proteins are a heterogeneous group, including clotting factor proteins and also proteins found in bone, lung, kidney, and placenta. Vitamin K mediates posttranslational modification of glutamate residues to  $\gamma$ -carboxyglutamate, a critical step for the activity of vitamin K–dependent proteins for calcium binding and proper assembly to phospholipid membranes (Fig. 19-2). Inherited deficiency of the functional activity of the enzymes involved in vitamin K metabolism, notably the GGCX or VKOR-1 (see earlier), results in bleeding disorders. The amount of vitamin K in the diet is often limiting for the carboxylation reaction, and thus recycling of the vitamin K is essential to maintain normal levels of vitamin K–dependent proteins. In adults, low dietary intake alone is seldom reason for severe vitamin K deficiency but may become common in association with the use of broad-spectrum antibiotics. Disease or surgical interventions that affect the ability of the intestinal tract to absorb vitamin K, either through anatomic alterations or by changing the fat content of bile salts and pancreatic juices in the proximal small bowel, can result in significant reduction of vitamin K levels. Chronic liver diseases such as primary biliary cirrhosis also deplete vitamin K stores. Neonatal vitamin K deficiency and the resulting hemorrhagic disease of the newborn have been almost entirely eliminated by routine administration of vitamin K to all neonates. Prolongation of PT values is the most common and earliest

finding in vitamin K–deficient patients due to reduction in prothrombin, FVII, FIX, and FX levels. FVII has the shortest half-life among these factors, which can prolong the PT before changes in the aPTT. Parenteral administration of vitamin K at a total dose of 10 mg is sufficient to restore normal levels of clotting factor within 8–10 h. In the presence of ongoing bleeding or a need for immediate correction before an invasive procedure, replacement with FFP or PCC is required. PCC should be avoided in patients with severe underlying liver disorders due to high risk of thrombosis. The reversal of excessive anticoagulant therapy with warfarin or warfarin-like drugs can be achieved by minimal doses of vitamin K (1 mg orally or by intravenous injection) for asymptomatic patients. This strategy can diminish the risk of bleeding while maintaining therapeutic anticoagulation for an underlying prothrombotic state.

## COAGULATION DISORDERS ASSOCIATED WITH LIVER FAILURE

The liver is central to hemostasis because it is the site of synthesis and clearance of most procoagulant and natural anticoagulant proteins and of essential components of the fibrinolytic system. Liver failure is associated with a high risk of bleeding due to deficient synthesis of procoagulant factors and enhanced fibrinolysis. Thrombocytopenia is common in patients with liver disease and may be due to congestive splenomegaly (hypersplenism), or immune-mediated shortened platelet life span (primary biliary cirrhosis). In addition, several anatomic abnormalities secondary to underlying liver disease further promote the occurrence of hemorrhage (Table 19-3). Dysfibrinogenemia is a relatively common finding in patients with liver disease due to impaired fibrin polymerization. The development of DIC concomitant to chronic liver disease is not uncommon and may enhance the risk for bleeding. Laboratory evaluation is mandatory for an optimal therapeutic strategy, either to control ongoing bleeding or to prepare the patients with liver disease for invasive procedures. Typically these patients present with prolonged PT, aPTT, and TT, depending on the degree of liver damage, thrombocytopenia, and normal or slight increase of FDP. Fibrinogen levels are diminished only in fulminant hepatitis, decompensated cirrhosis, or advanced liver disease, or in the presence of DIC. The presence of prolonged TT, normal fibrinogen, and FDP levels suggests dysfibrinogenemia. FVIII levels are often normal or elevated in patients with liver failure, and decreased levels suggest superimposing DIC. Because FV is only synthesized in the hepatocyte and is not a vitamin K–dependent protein, reduced levels of FV may be an indicator of hepatocyte failure. Normal levels of FV and low levels of FVII suggest vitamin K deficiency. Vitamin K levels may be reduced in patients with liver failure due to compromised storage in hepatocellular disease, changes in bile

**COAGULATION DISORDERS AND HEMOSTASIS  
IN LIVER DISEASE****Bleeding**

Portal hypertension  
 Esophageal varices  
 Thrombocytopenia  
 Splenomegaly  
 Chronic or acute DIC  
 Decreased synthesis of clotting factors  
 Hepatocyte failure  
 Vitamin K deficiency  
 Systemic fibrinolysis  
 DIC  
 Dysfibrinogenemia

**Thrombosis**

Decreased synthesis of coagulation inhibitors:  
 protein C, protein S, antithrombin  
 Hepatocyte failure  
 Vitamin K deficiency (protein C, protein S)  
 Failure to clear activated coagulation proteins (DIC)  
 Dysfibrinogenemia  
 Iatrogenic: Transfusion of prothrombin complex  
 concentrates  
 Antifibrinolytic agents:  $\epsilon$ -aminocaproic acid (EACA),  
 tranexamic acid

**Note:** DIC, disseminated intravascular coagulation.

acids, or cholestasis that can diminish the absorption of vitamin K. Replacement of vitamin K may be desirable (10 mg given by slow intravenous injection) to improve hemostasis.

Treatment with FFP is the most effective way to correct hemostasis in patients with liver failure. Infusion of FFP (5–10 mL/kg; each bag contains ~200 mL) is sufficient to ensure 10–20% of normal levels of clotting factors but not correction of PT or aPTT. Even high doses of FFP (20 mL/kg) do not correct the clotting times in all patients. Monitoring for clinical symptoms and clotting times will determine if repeated doses are required 8–12 h after the first infusion. Platelet concentrates are indicated when platelet counts are  $<10,000\text{--}20,000/\text{mm}^3$  to control an ongoing bleed or immediately before an invasive procedure if counts are  $<50,000/\text{mm}^3$ . Cryoprecipitate is indicated only when fibrinogen levels are  $<100\text{ mg/mL}$ ; dosing is six bags for a 70-kg patient daily. As noted earlier, PCC infusion in patients with liver failure should be avoided due to the high risk of thrombotic complications. The safety of antifibrinolytic drugs to control bleeding in patients with liver failure is not yet well defined and should be avoided.

**ACQUIRED INHIBITORS OF COAGULATION FACTORS**

An *acquired inhibitor* is an immune-mediated disease characterized by the presence of an autoantibody against a

specific clotting factor. FVIII is the most common target of antibody formation, but inhibitors to prothrombin, FV, FIX, FX, and FXI are also reported. The disease occurs predominantly in older adults (median age: 60 years) but occasionally in pregnant or postpartum women with no previous history of bleeding. In 50% of patients with inhibitors, no underlying disease is identified at the time of diagnosis. In the remaining half, the causes are autoimmune diseases, malignancies (lymphomas, prostate cancer), dermatologic diseases, and pregnancy. Previous history of open surgery in which topical thrombin is used, especially preparations containing bovine FV, is sometimes associated. Bleeding episodes occur commonly into soft tissues and in the gastrointestinal or urinary tracts and skin. In contrast to hemophilia, hemarthrosis is rare. Retroperitoneal hemorrhages and other life-threatening bleeding may appear suddenly. The overall mortality in untreated patients ranges from 8–22%, and most deaths occur within the first few weeks after presentation. The diagnosis is based on the prolonged aPTT with normal PT and TT. The aPTT remains prolonged after mixture of the test plasma with equal amounts of pooled normal plasma for 2 h at 37°C. The Bethesda assay using FVIII-deficient plasma as performed for inhibitor detection in hemophilia will confirm the diagnosis. Major bleeding is treated with high doses of human or porcine FVIII, PCC/PCCa, or recombinant FVIIa. High-dose IV  $\gamma$  globulin and anti-CD20 monoclonal antibody (rituximab) have been reported to be effective in patients with autoantibodies to FVIII. In contrast to hemophilia, inhibitors in nonhemophilia patients are sometimes responsive to prednisone alone or in association with cytotoxic therapy (e.g., cyclophosphamide).

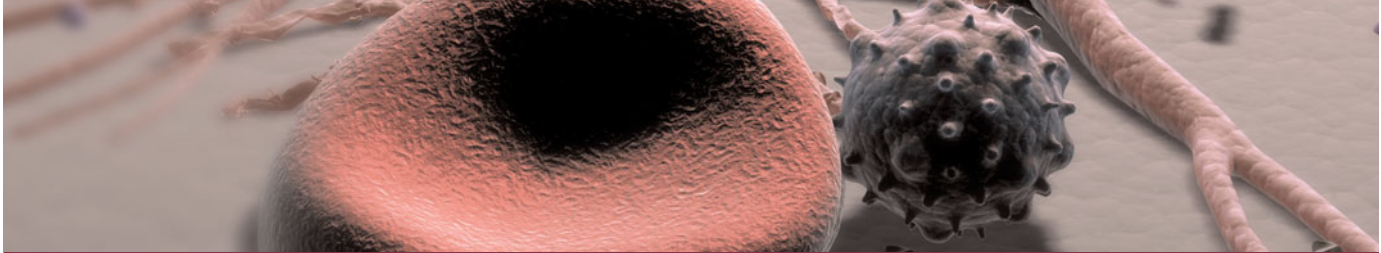
The presence of lupus anticoagulant can be associated with venous or arterial thrombotic disease. However, bleeding has also been reported in lupus anticoagulant; it is due to the presence of antibodies to prothrombin, which results in hypoprothrombinemia. Both disorders show a prolonged PTT that does not correct on mixing. To distinguish acquired inhibitors from lupus anticoagulants, the dilute Russell's viper venom test and the hexagonal-phase phospholipids test will be negative in patients with an acquired inhibitor and positive in patients with lupus anticoagulants. Moreover, lupus anticoagulant interferes with the clotting activity of many factors (FVIII, FIX, FXII, FXI), whereas acquired inhibitors are specific to a single factor.

**FURTHER READINGS**

- ANG AL et al: Acquired factor V inhibitor. A problem-based systematic review. *Thromb Haemost* 101:852, 2009
- CALDWELL SH et al: Coagulation disorders and hemostasis in liver disease: Pathophysiology and critical assessment of current management. *Hepatology* 44:1039, 2006
- FRANCHINI M et al: Interpatient phenotypic inconsistency in severe congenital hemophilia: A systematic review of the role of inherited thrombophilia. *Semin Thromb Hemost* 35:307, 2009

HOYER LW: Hemophilia A. *N Engl J Med* 330:39, 1994  
KEY NS, NEGRIER C: Coagulation factor concentrates: Past, present, and future. *Lancet* 370:439, 2007  
LEVI M, OPAL SM: Coagulation abnormalities in critically ill patients. *Critical Care* 10:222, 2006  
MANNUCCI PM et al: Recessively inherited coagulation disorders. *Blood* 104:1243, 2004

STAFFORD DW: The vitamin K cycle. *J Thromb Haemost* 3:1873, 2005  
TAGARIELLO G et al: Comparison of the rates of joint arthroplasty in patients with severe factor VIII and IX deficiency: An index of different clinical severity of the two coagulation disorders. *Blood* 114:779, 2009  
VIHALA NO et al: Gene therapy for hemophilia: Clinical trials and technical tribulations. *Semin Thromb Hemost* 35:81, 2009



## CHAPTER 20

# VENOUS THROMBOSIS

Frits R. Rosendaal ■ Harry R. Büller

Epidemiology	246
Etiology	246
Prognosis	247
Prevention	248
Hereditary Thrombophilia	248
Thrombosis at Rare Sites	249
Superficial Thrombophlebitis	249
Global Data	249
Diagnosis	249
■ Further Readings	252

Venous thrombosis is the result of occlusive clot formation in the veins. It occurs mainly in the deep veins of the leg (deep vein thrombosis, or DVT), from which parts of the clot frequently embolize to the lungs (pulmonary embolism, or PE). Fewer than 5% of all venous thromboses occur at other sites (see “Thrombosis at Rare Sites,” and “Superficial Thrombophlebitis” later). Venous thrombosis is common and often occurs spontaneously, but it also frequently accompanies medical and surgical conditions, both in the community and the hospital.

The symptoms of venous thrombosis are nonspecific, and therefore the clinical diagnosis is difficult and requires objective testing by imaging. Major complications of thrombosis include a disabling postthrombotic syndrome and death due to fatal PE. Treatment with anticoagulants should be prompt and adequate.

Many risk factors for thrombosis are known, all of them related either to immobilization or to hypercoagulability. Although it has no utility to assess the risk factor status after thrombosis has occurred, several acquired risk factors are so strong that they warrant prophylactic anticoagulation, in both those with and without a history of thrombosis. Detailed guidelines for primary prevention are available.

Venous thrombosis tends to recur. The risk factors for a first venous thrombosis are not the same as for recurrent

venous thrombosis and to a large extent are unknown. Individuals from families with inherited thrombophilia tend to develop thrombosis at a young age and to have frequent recurrences.

### EPIDEMIOLOGY



The incidence of a first venous thrombosis is 1–3 per 1000 persons per year. Around two-thirds manifest as DVT of the leg, and one-third as PE. Up to half of patients with PE have no signs of DVT. From 1–10% of venous thromboses prove fatal, with deaths predominantly, but not exclusively, among the elderly or in patients with severe underlying disease, notably cancer. The incidence of venous thrombosis is exponentially related to age, where a rule of 10 applies: in children the incidence is 1 per 100,000 per year; in young adults, 1 in 10,000 per year; in the middle-aged, 1 per 1000 per year; in the elderly the incidence is 1% per year, up to nearly 10% per year in the very oldest. The recurrence rate of venous thrombosis is 3–10% per year.

### ETIOLOGY

The causes of thrombosis can be divided into those associated with immobilization, which are usually acquired, and those associated with hypercoagulability,

TABLE 20-1

## RISK FACTORS FOR VENOUS THROMBOSIS

ACQUIRED	INHERITED	MIXED/UNKNOWN
Orthopedic surgery	Antithrombin deficiency	High levels of factor VIII
Neurosurgery	Protein C deficiency	High levels of factor IX
Major abdominal surgery	Protein S deficiency	High levels of factor XI
Major trauma	Factor V Leiden (FVL)	High levels of fibrinogen
Central venous catheters	Prothrombin 20210A	High levels of TAFI
Malignancy	Non-O blood group	Low levels of TFPI
Antiphospholipid syndrome	Dysfibrinogenemia	APC resistance in the absence of FVL
Puerperium	Factor XIII 34val	Hyperhomocysteinemia
Prolonged bed rest		High levels of PCI (PAI-3)
Pregnancy		
Obesity		
Plaster cast		
Oral contraceptives		
Hormonal replacement therapy		
Myeloproliferative disorders		
Polycythemia vera		
Long-haul travel		
Age		

**Note:** TAFI, thrombin activatable fibrinolysis inhibitor; TFPI, tissue factor pathway inhibitor; PCI, protein C inhibitor; PAI-3, plasminogen activator inhibitor-3; APC, activated protein C.

which can be either genetic or acquired (Table 20-1). Venous thrombosis is a multicausal disease that occurs when several risk factors are present simultaneously in a particular combination. Often, long-term risk factors, e.g., genetic defects, are joined by short-term acquired factors (Fig. 20-1). Although many factors simply add to the risk, contributing to an individual's "thrombosis potential," some factors may interact synergistically, when the combination adds more to the risk than the sum of the separate contributions of the risk factors (e.g., factor V Leiden and oral contraceptive use).

Several acquired risk factors are very strong, causing thrombosis in several percent of those afflicted, which implies a relative risk of  $\geq 50$ . These are orthopedic, neurosurgical, and major abdominal interventions; major trauma with multiple fractures; central venous catheters; and metastasized cancer, particularly adenocarcinomas. Moderate risk factors are antiphospholipid antibody syndrome, puerperium, prolonged bedrest, and nonmetastasized cancers; pregnancy, oral contraceptive use, hormone replacement therapy, obesity, and long-distance travel are mild risk factors, with a two- to fivefold increased risk.

Homozygous protein C or protein S deficiency leads to potentially fatal purpura fulminans directly after birth; homozygous antithrombin deficiency is not compatible with life. These are exceedingly rare, except in communities with a high frequency of consanguinity. Heterozygous antithrombin deficiency and homozygous factor V Leiden are the strongest genetic risk factors, increasing the risk of thrombosis twenty- to fiftyfold. Heterozygous protein C and protein S deficiencies are moderate contributors to

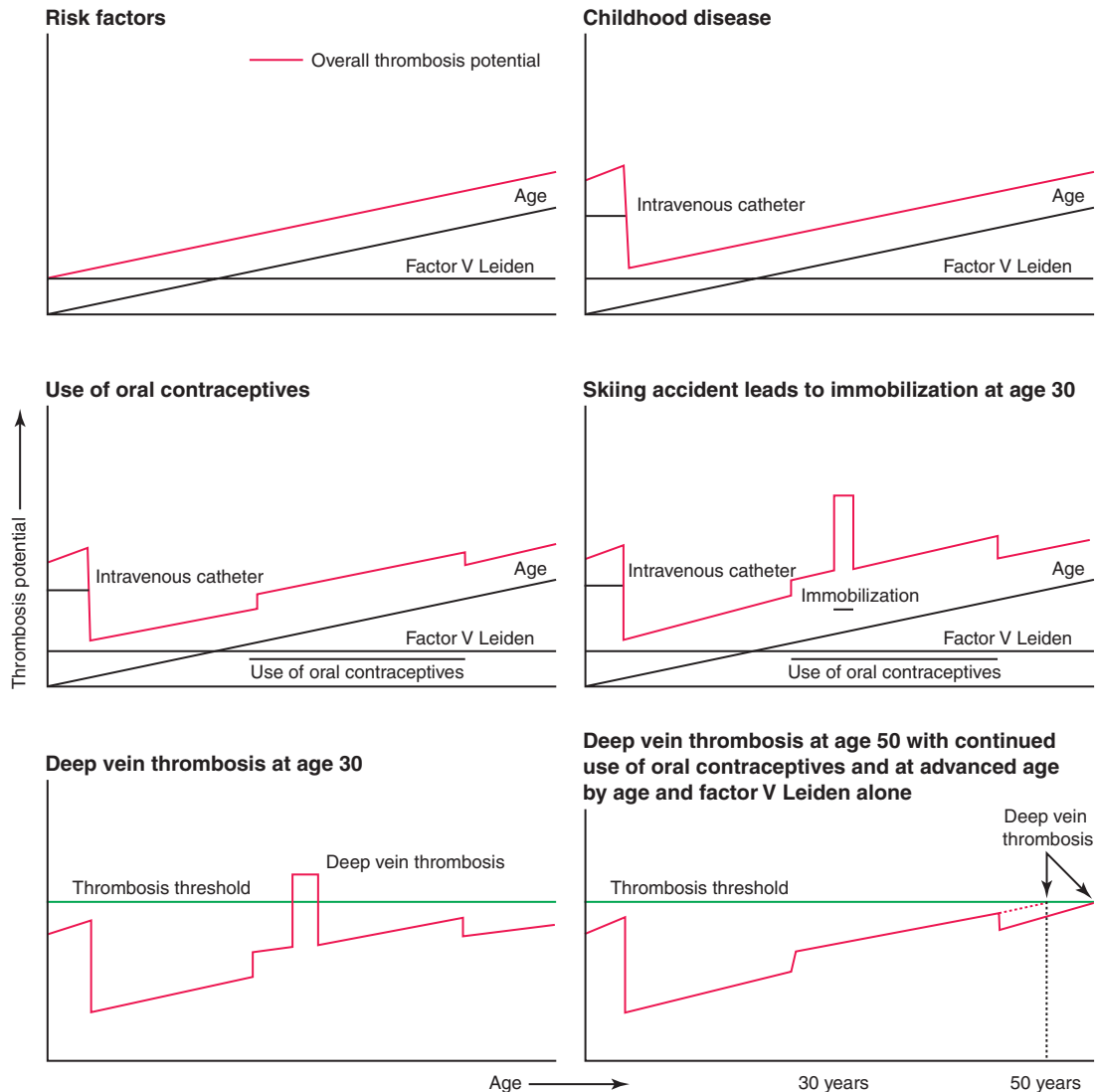
risk, with a relative risk of 10. Other genetic factors that are associated with venous thrombosis are either mild and increase the risk two- to fivefold (as is the case for factor V Leiden, prothrombin 20210A, and non-O blood groups) or have negligible effects on risk that are only of academic interest (MTHFR 677T, factor V HR2, FXIII val34leu, PAI-1 4G/5G).

Mildly increased risks are also present for abnormalities in the coagulation system of which the origin is unclear, such as elevated levels of procoagulant factors (fibrinogen, II, von Willebrand's factor, VIII, IX, X, and XI) and antifibrinolytic factors (TAFI), and low levels of anticoagulant factors (TFPI) (Table 20-1).

## PROGNOSIS

Patients who have had a venous thrombosis have a high risk (3–10% per year) of another. Up to half of the recurrences after a first thrombosis in one leg occur in the other, indicating that systemic changes rather than residual local damage are associated with rethrombosis. Nevertheless, few of the established risk factors associated with a hypercoagulable state (such as factor V Leiden, prothrombin 20210A, and elevated levels of clotting factors VIII, IX, and XI) are associated with recurrence risk. Even the strongest prothrombotic abnormalities—antithrombin, protein C, and protein S deficiencies—increase the risk of recurrent thrombosis by 50% at most. The only two clear risk factors for recurrence are male sex (increasing risk three- to fourfold) and the absence of a clear precipitating factor at the first event (doubling recurrence risk); in



**FIGURE 20-1**

**Models of thrombosis risk.** In each panel, the figure shows the thrombosis (black) potential of each risk factor present during an individual's life and the resultant thrombosis

potential (red). (From FR Rosendaal: *Venous thrombosis: A multicausal disease. Lancet* 353:1167, 1999; with permission.)

other words, a first thrombosis following surgery or plaster cast is unlikely to recur.

Acquired risk factors, such as surgery, immobilization, and cancer, increase the risk of recurrent thrombosis—as they increase the risk of a first event.

## PREVENTION

The presence of prothrombotic defects or a history of thrombosis does not usually lead to different preventative strategies, with the exception of the postpartum period, where anticoagulation seems indicated, particularly for antithrombin deficiency. Similarly, the decision for long-term or lifelong anticoagulation, i.e., beyond the period of increased risk, depends on the clinical presentation rather than on the presence of prothrombotic abnormalities. Before prescribing long-term anticoagulation, clinicians should be aware of the cumulative annual risk of major hemorrhage of 1–2%.

Patients with a history of thrombosis should not use estrogen-containing drugs, i.e., hormone replacement therapy is contraindicated and for contraception, mechanical methods are preferred.

## Thrombophilia Testing

Testing for prothrombotic abnormalities outside the setting of abundant familial thrombophilia serves no purpose. A positive test does not help in the diagnosis of thrombosis, nor does it predict the risk of recurrent thrombosis, nor, therefore, does it affect long-term preventative strategies.

## HEREDITARY THROMBOPHILIA

Individuals from families with a hereditary tendency for venous thrombosis generally have a more severe thrombotic tendency than individuals not from such families. Even when the genetic defect is the same in the two

groups, those with hereditary thrombophilia from affected families have their first thrombosis at a young age (20–35 years), few fail to develop thrombosis in their lifetime, and many have recurrent disease. Early studies on thrombotic risk associated with prothrombotic defects were based on such families and overestimated risks for all patients with thrombophilic defects. Generally, individuals from such families need not be treated differently than others, except (1) oral contraceptives containing estrogens should be discouraged in all, and (2) postpartum anticoagulant prophylaxis should be considered in those with prothrombotic defects. Long-term treatment can be considered after a first episode of thrombosis, but only in high-risk families, particularly those with antithrombin deficiency.

## THROMBOSIS AT RARE SITES

One in 25 venous thromboses occurs in the arm; other, even more rare locations are the brain (cerebral vein thrombosis), the digestive system (mesenteric vein thrombosis), and the liver (portal vein thrombosis, and hepatic vein thrombosis, also known as *Budd-Chiari syndrome*). Thrombosis of the arm is almost invariably associated with central venous catheters. Deteriorating liver function and portal hypertension may point to thrombosis in the hepatic or portal veins, neurologic defects to cerebral vein thrombosis, and severe abdominal complaints to mesenteric vein thrombosis. In rare cases, DVT may be associated with embolic stroke, when a patent foramen ovale is present (paradoxical stroke). Although local abnormalities often play a role, a procoagulant state due to cancer or hereditary abnormalities increases the incidence of thrombosis in rare locations. In all these cases diagnosis is based on imaging, and treatment should consist of anticoagulation similar to that of more common forms of thrombosis, as well as treatment of local causes and consequences.

## SUPERFICIAL THROMBOPHLEBITIS

A painful red string is a clear sign of superficial thrombophlebitis. This is the only type of venous thrombosis that can reliably be diagnosed without imaging techniques. Although research is limited, the causes of superficial thrombophlebitis appear similar to those of other forms of venous thrombosis, and extension to the deep vein occurs. Treatment options are a matter of debate and vary from anticoagulants to an expectant approach.

## GLOBAL DATA



Venous thrombosis occurs in all ethnic groups, with possibly a somewhat higher incidence in Africans than in whites and Asians. Whereas acquired risk factors are largely identical in these large ethnic groups, the two most common genetic risk factors

(factor V Leiden and prothrombin 20210A) are found only in whites. These are unique gain-of-function mutations with a very low mutation rate (i.e., they occurred only once). Loss-of-function mutations leading to deficiencies of antithrombin, protein C, and protein S do not differ much by ethnic group. Due to founder effects, prevalences of factor V Leiden and prothrombin 20210A may vary widely in ethnic subpopulations, i.e., in various European populations the prevalence of factor V Leiden varies between 1% (Italy) and 15% (southern Sweden). Acquired risk factors may vary by local circumstances, e.g., hyperhomocysteinemia due to differences in diet, reproductive factors due to number of pregnancies, and use of oral contraceptives. The literature on Africans and Asians is sparse.

## DIAGNOSIS

The true prevalence of thrombosis in patients presenting with either clinically suspected DVT of the leg or PE is ~15–25%. Therefore, the diagnostic workup for both these diseases has two objectives: (1) to exclude the disease quickly and safely in as many patients as possible, preferably with noninvasive and easy-to-use and cost-effective methods; and (2) to confirm the presence of thrombosis in the remaining patients with an accurate imaging technique. The purpose of the first step is to withhold both unnecessary further diagnostic testing and anticoagulant treatment. Although the diagnostic workup of DVT and PE have much in common, they are discussed separately.

### Deep Vein Thrombosis

The signs and symptoms of DVT, such as swelling, pain, redness, superficial venous dilatation, and Homan's sign (pain in the calf or behind the knee on dorsiflexion of the ankle), are nonspecific and consequently insufficient for ruling the disease in or out. The classic “gold standard” is contrast venography. Although very accurate, this method requires radiologic facilities and expertise and is invasive and sometimes uncomfortable for the patient. Ultrasonography, with noncompressibility of the vein as the sole criterion, has largely replaced contrast venography. The investigation is limited to the femoral vein in the groin and the popliteal vein in the popliteal fossa. This method has a very high sensitivity and specificity (95–100%) in symptomatic patients for proximal DVT. For isolated DVT in the calf veins, the method is less accurate. This latter characteristic of compression ultrasonography explains the necessity of repeating the test after ~1 week in those patients with an initial normal test result in order to detect extending calf thrombi. However, the first objective of the diagnostic workup was to rule out DVT quickly and safely. For this purpose the combination of the assessment of clinical probability and the measurement of the D-dimer blood concentration has been shown to be very useful. The clinical

### CLINICAL DECISION RULE FOR DIAGNOSING THROMBOSIS

#### Decision Rule for Clinically Suspected Deep Vein Thrombosis (DVT)

	Points
Active cancer (patient receiving treatment for cancer within the previous 6 months or currently receiving palliative treatment)	1
Paralysis, paresis, or recent plaster immobilization of the lower extremities	1
Recently bedridden for $\geq 3$ days or major surgery within the previous 12 weeks requiring general or regional anesthesia	1
Localized tenderness along the distribution of the deep venous system	1
Entire leg swollen	1
Calf swelling at least 3 cm larger than that on the asymptomatic side (measured 10 cm below tibial tuberosity)	1
Pitting edema confined to the symptomatic leg	1
Collateral superficial veins (nonvaricose)	1
Previously documented deep vein thrombosis	1
Alternative diagnosis at least as likely as deep vein thrombosis	-2
Score $< 2$ : DVT unlikely	
Score $\geq 2$ : DVT likely	

#### Decision Rule for Clinically Suspected Pulmonary Embolism (PE)

	Points
Clinical signs and symptoms of deep vein thrombosis (minimum of leg swelling and pain with palpation of the deep veins)	3
Alternative diagnosis less likely than pulmonary embolism	3
Heart rate $> 100$ /min	1.5
Immobilization ( $> 3$ days) or surgery in the previous 4 weeks	1.5
Previous pulmonary embolism or deep vein thrombosis	1.5
Hemoptysis	1
Malignancy (receiving treatment, treated in the last 6 months or palliative)	1
Score $\leq 4$ : PE unlikely	
Score $> 4$ : PE likely	

probability can be best assessed by the rule shown in [Table 20-2](#), which results in a classification of either DVT likely or DVT unlikely. D-Dimer is a degradation product of cross-linked fibrin, and therefore concentrations of D-dimer below a certain cutoff level are considered to indicate the absence of thrombosis. Elevations of D-dimer in patients  $> 70$  years of age who do not have thrombosis make the test less useful in this population.

Withholding further diagnostic testing and anticoagulant treatment in those patients with an unlikely clinical

probability and a normal D-dimer level, which constitutes 30–50% of all referred patients, is safe. The remaining patients need to undergo (repeated) compression ultrasonography. An alternative approach is to perform a whole-leg imaging test on the day of referral. The advantage of this approach is that it eliminates the need for a repeat test (and may even obviate the probability assessment and D-dimer testing). The major disadvantage is the detection and likely treatment of a substantial number of isolated calf DVTs that may otherwise have lysed spontaneously.

### Pulmonary Embolism

The signs and symptoms of PE, such as dyspnea, pleuritic chest pain, cough, and hemoptysis, are nonspecific and, as for DVT, insufficiently accurate to confirm or refute the diagnosis of PE. The classic gold standard is pulmonary angiography, which is an invasive method requiring expertise. Hence, very similar to the developments in the diagnosis of DVT, two (complementary) strategies have evolved. The first is the combination of the assessment of clinical probability and the measurement of the D-dimer blood level; the second is the introduction of spiral CT of the chest. The clinical probability can be categorized accurately using the rule developed for suspected PE ([Table 20-2](#)). In those with an unlikely probability, a D-dimer test should be performed and, if normal, the disease can be safely ruled out and no anticoagulant therapy is indicated. Depending on the referral pattern of patients, this combination rules out PE in 30–60% of all referred patients. Those with either a likely clinical probability at presentation or an abnormal D-dimer (and unlikely probability) need to undergo an imaging test.

At present the most attractive method is the multi-slice spiral CT of the chest. This technique accurately detects PE and, if normal, has been shown to also safely rule out the presence of emboli. Another advantage is the possibility of detecting an alternative disease in the thorax in those in whom PE is excluded, which may provide an explanation for the presenting symptoms. Alternative diagnostic methods in the workup of suspected PE are perfusion-ventilation scintigraphy, ultrasonography of the legs, and pulmonary angiography. Although a normal perfusion scan adequately rules out PE and a high probability perfusion-ventilation scan adequately rules in PE, the major disadvantages are the high proportion of nondiagnostic test results ( $\sim 50\%$ ) and therefore the need for additional (costly) testing, usually with pulmonary angiography.

The role of compression ultrasonography of the legs before angiography or spiral CT is limited because only a small fraction of patients have abnormal results and it further complicates the workup.

## **R<sub>x</sub>** **Treatment:** **DEEP VEIN THROMBOSIS AND PULMONARY EMBOLISM**

The objectives of anticoagulant treatment for DVT and PE are to minimize local extension of the disease in the acute phase and to reduce the risk of recurrence of the disease in the months to years after the initial episode. In addition, in DVT, treatment lowers the risk of the development of the postthrombotic syndrome (swelling, stasis dermatitis, ulceration, venous claudication); in PE, treatment reduces the risk of pulmonary hypertension.

A spectrum of treatment options is available. At one end an expectant approach is indicated with no treatment in the setting of minimal disease without a tendency to extend or recur (as is the case, for example, with small calf thrombi). At the other end is the DVT or PE that is massive, either with serious compromise of lung perfusion or with impending gangrene of the leg. In these circumstances, aggressive treatment with either thrombolysis or even surgical intervention may be required. However, the vast majority of patients with DVT or PE require treatment in the middle part of the spectrum, which consists of the use of anticoagulants, usually low-molecular-weight heparin (LMWH) and a vitamin K antagonist (VKA) such as warfarin. Although the treatments of DVT and PE have much in common, they are discussed separately.

**DEEP VEIN THROMBOSIS** The standard treatment for DVT consists of an initial course of LMWH, given once or twice daily via SC injection at a dose of 100 U/kg, followed by a VKA. Unfractionated heparin given IV is an alternative for LMWH but is less and less used these days. LMWH does not require laboratory monitoring and is given in a fixed dose, usually adapted for body weight (categories). An alternative for the initial LMWH therapy is the short-acting synthetic pentasaccharide fondaparinux, which can be given as a once-a-day SC injection

of 2.5 mg, without laboratory monitoring. Therapy with LMWH or fondaparinux should be started as soon as the diagnosis is confirmed or during the diagnostic workup if the clinical suspicion is high. VKA (warfarin) can be safely started at the same day, and the dose is titrated according to the international normalized ratio (INR) with a target of 2.5 (range: 2–3). LMWH therapy should be continued for at least 5 days and can be discontinued if the INR is >2 on two consecutive measurements at least 24 h apart. The recommendations for the duration of VKA treatment for a first episode of DVT are summarized in **Table 20-3**. For a first DVT secondary to a transient (reversible) risk factor, such as following surgery, after immobilization, or associated with oral contraceptive use, a treatment duration of 3 months with a VKA is recommended. For patients with a first episode of idiopathic DVT, the recommendation is to treat for 6–12 months. At present, evidence is insufficient to treat patients with a first episode of DVT and a documented thrombophilic abnormality differently from those with idiopathic thrombosis. Hence the recommendation is also 6–12 months of VKA. A duration of 12 months is recommended for patients with a first episode of DVT with documented antiphospholipid antibodies or two or more thrombophilic abnormalities. The decision to continue VKA treatment after 6–12 months requires the balancing of the risks of recurrence and bleeding and should take the patient's preference into account. No strong recommendations exist about the treatment duration for a second episode of DVT, but minimally 12 months are usually given and often treatment is continued longer. Again, this decision requires the balancing of risk and benefit.

The preferred intensity of VKA treatment for DVT is an INR between 2 and 3. Higher intensities are not more effective, whereas lower intensities are less effective with a similar bleeding risk. Although VKAs are generally used for long-term treatment, LMWH is preferred in

**TABLE 20-3**

### **LONG-TERM TREATMENT WITH VITAMIN K ANTAGONISTS FOR DEEP VEIN THROMBOSIS (DVT) AND PULMONARY EMBOLISM (PE)**

<b>PATIENT CATEGORIES</b>	<b>DURATION, MONTHS</b>	<b>COMMENTS</b>
First episode of DVT or PE secondary to a transient (reversible) risk factor	3	Recommendation applies to both proximal and calf vein thrombosis
First episode of idiopathic DVT or PE	6–12	Continuation of anticoagulant therapy after 6–12 months may be considered
First episode of DVT or PE with a documented thrombophilic abnormality	6–12	Continuation of anticoagulant therapy after 6–12 months may be considered
First episode of DVT or PE with documented antiphospholipid or two or more thrombophilic abnormalities	12	Continuation of anticoagulant therapy after 12 months may be considered

patients with DVT and concomitant cancer. This treatment is associated with a lower risk of recurrent thrombosis than VKA and a similar risk of bleeding.

The role of thrombolytic therapy as well as surgical removal of the thrombus in the initial treatment of DVT is controversial; the current recommendations are to refrain from their use with the single exception of patients with massive, recent iliofemoral DVT at risk of limb gangrene.

Patients with DVT are at risk of developing the post-thrombotic syndrome in the first years after the initial episode. This syndrome can range from mild, with some swelling and pain at the end of the day, to severe, with massive swelling and skin ulceration. Graduated elastic compression stockings to the knee with an ankle pressure of 30–40 mm Hg fitted in the first weeks after the initial thrombosis and worn for 2 years reduce the risk of the postthrombotic syndrome by ~50%.

As a result of the introduction of LMWH for the initial treatment of DVT, most patients with DVT can be treated at home either entirely or after a short hospital stay. The LMWH can be self-injected or given by family members or visiting nurses.

**PULMONARY EMBOLISM** The initial treatment with LMWH followed by a VKA for patients with PE is identical to that for patients with DVT. The intensity and duration of VKA treatment is also no different (Table 20-3). An alternative for LMWH is unfractionated heparin, which is still often used. The main disadvantage of unfractionated heparin is the need for continuous IV infusion and the requirement of frequent laboratory monitoring and dose adjustments. In contrast, LMWH can be given in fixed doses adjusted only for body weight. Another alternative for the initial LMWH therapy is fondaparinux, which can be given as a 2.5-mg once-a-day SC injection, without laboratory monitoring.

The treatment with LMWH or fondaparinux followed by VKA is indicated for PE patients who are hemodynamically stable—the great majority of patients. However, for those patients with PE who are hemodynamically unstable (usually defined as a systolic blood pressure <90–100 mmHg), a course of thrombolytic therapy should be considered. When no contraindications for thrombolysis (such as recent surgery or a

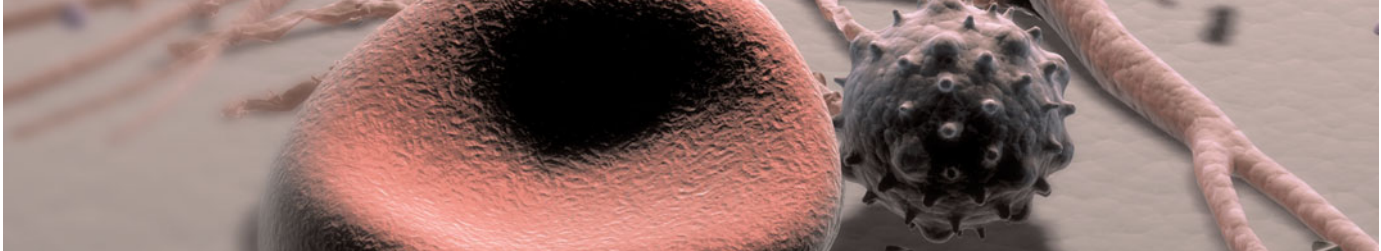
bleeding diathesis) exist, this therapy reduces the short-term risk of recurrent PE or death by ~50% as compared to heparin. Although streptokinase and urokinase have been used in patients with PE, the most widely applied regimen is recombinant tissue plasminogen activator (tPA) (bolus of 10 mg IV, followed by 90 mg in 2 h).

A controversial area is the best therapy for PE patients who are hemodynamically stable but who have echocardiographic evidence of right ventricular dysfunction (usually defined as paradoxical interventricular septal motion and right ventricular dilatation and impaired systolic function). Although these patients have a higher mortality risk compared to patients without right ventricular dysfunction, it is unclear whether more aggressive therapy (with thrombolytic therapy or catheter removal of thrombus) is beneficial in terms of mortality, recurrent PE, and major hemorrhage.

Another area of controversy is vena caval interruption, usually with caval filters. The current recommendation is that a filter, preferably removable, should be considered only for patients with a contraindication for anticoagulant therapy, as well as in those with recurrent PE despite adequate treatment.

## FURTHER READINGS

- BASKIN JL et al: Management of occlusion and thrombosis associated with long-term indwelling central venous catheters. *Lancet* 374:159, 2009
- BERTINA RM: The role of procoagulants and anticoagulants in the development of venous thromboembolism. *Thromb Res* 123 (suppl 4):S41, 2009
- COLMAN RW et al (eds): *Hemostasis and Thrombosis: Basic Principles and Clinical Practice*, 5th ed. Philadelphia, Lippincott Williams & Wilkins, 2006
- HENKE PK, WAKEFIELD T: Thrombus resolution and vein wall injury: Dependence on chemokines and leukocytes. *Thromb Res* 123 (suppl 4):S72, 2009
- PRANDONI P: Links between arterial and venous disease. *J Intern Med* 262:341, 2007
- ROSENDAAL FR: Venous thrombosis, a multicausal disease. *Lancet* 353:1167, 1999
- SEGAL JB et al: Predictive value of factor V Leiden and prothrombin G20210A in adults with venous thromboembolism and in family members of those with a mutation: A systematic review. *JAMA* 301:2472, 2009
- THE SEVENTH ACCP CONFERENCE ON ANTITHROMBOTIC AND THROMBOLYTIC THERAPY: *Chest* 126(3 Suppl):167S, 2004



## CHAPTER 21

# PULMONARY THROMBOEMBOLISM

Samuel Z. Goldhaber

Epidemiology .....	253
Pathophysiology .....	254
Diagnosis .....	254
Prevention of VTE .....	262
■ Further Readings .....	263

### EPIDEMIOLOGY

A quiet revolution has occurred in the field of venous thromboembolism (VTE), which encompasses deep venous thrombosis (DVT) and pulmonary embolism (PE). VTE is no longer an orphan disease. Its adverse public health impact has been acknowledged in the United States by the National Quality Forum, the Joint Commission for Accreditation of Hospitals, the National Comprehensive Cancer Network, and the Surgeon General's Office. Public service announcements have educated laypersons on the definition and medical consequences of DVT and PE, along with risk factors and warning signs. VTE-related deaths in the United States are estimated at 300,000 annually: 7% diagnosed with VTE and treated, 34% sudden fatal PE, and 59% as undetected PE. Approximately two-thirds of symptomatic VTE events are hospital acquired, and the remainder are community acquired. Residents of skilled nursing facilities are especially vulnerable. The most recent estimates of hospitalized patients at risk for VTE in the United States total 13.4 million patients annually: 5.8 million surgical patients at moderate to high risk and 7.6 million medical patients with comorbidities such as heart failure, cancer, and stroke. These new data provide the rationale for changing the prophylaxis paradigm from voluntary to mandatory compliance with guidelines to prevent VTE among hospitalized patients.

VTE is also a major European health problem, with an estimated 370,000 per year PE-related deaths when data in France, Germany, Spain, Italy, Sweden, and the United Kingdom are combined. The estimated direct

cost for VTE-associated care in Europe exceeds 3 billion euros per year.

Although DVT and PE encompass one disease entity, VTE, there are important differences. DVT occurs about three times more often than PE. The major adverse outcome of DVT alone, without PE, is the development of *postphlebotic syndrome*, which occurs in more than half of patients with DVT. Postphlebotic syndrome is a late adverse effect of DVT that is caused by permanent damage to the venous valves of the leg, which become incompetent and permit abnormal exudation of interstitial fluid from the venous system. It may not become clinically manifest until several years after the initial DVT. There is no effective medical therapy for this condition, which impairs quality of life and disables. Most patients describe chronic ankle swelling and calf swelling and aching, especially after prolonged standing. In its most severe form, postphlebotic syndrome causes skin ulceration, especially in the medial malleolus of the leg. PE can be fatal or can cause chronic thromboembolic pulmonary hypertension, with breathlessness at rest or with mild exertion. Patients with PE are more likely to suffer recurrent VTE than patients with DVT alone.

Genetic and acquired factors contribute to the likelihood of VTE. The two most common autosomal dominant genetic mutations are the factor V Leiden and the prothrombin gene mutations (Chap. 3). However, only a minority of patients with VTE have identifiable predisposing genetic factors. Most patients with predisposing genetic factors will not develop clinical evidence of clotting. Acquired predispositions include long-haul air

254 travel, obesity, cigarette smoking, oral contraceptives, pregnancy, postmenopausal hormone replacement, surgery, trauma, and medical conditions such as antiphospholipid antibody syndrome, cancer, systemic arterial hypertension, and chronic obstructive pulmonary disease. Thrombophilia contributes to the risk of venous thrombosis, often due to an inherited risk factor in combination with an acquired predisposition.

## PATHOPHYSIOLOGY

### Embolization

When venous thrombi dislodge from their site of formation, they embolize to the pulmonary arterial circulation or, paradoxically, to the arterial circulation through a patent foramen ovale or atrial septal defect. About half of patients with pelvic vein thrombosis or proximal leg DVT develop PE, which is usually asymptomatic. Isolated calf vein thrombi pose a much lower risk of PE, but they are the most common source of paradoxical embolism. These tiny thrombi can cross a small patent foramen ovale or atrial septal defect, unlike larger, more proximal leg thrombi. With increased use of chronic indwelling central venous catheters for hyperalimentation and chemotherapy, as well as more frequent insertion of permanent pacemakers and internal cardiac defibrillators, upper extremity venous thrombosis is becoming a more common problem. These thrombi rarely embolize and cause PE.

### Physiology

The most common gas exchange abnormalities are hypoxemia (decreased arterial  $PO_2$ ) and an increased alveolar-arterial  $O_2$  tension gradient, which represents the inefficiency of  $O_2$  transfer across the lungs. Anatomic dead space increases because breathed gas does not enter gas exchange units of the lung. Physiologic dead space increases because ventilation to gas exchange units exceeds venous blood flow through the pulmonary capillaries.

Other pathophysiological abnormalities include the following:

1. *Increased pulmonary vascular resistance* due to vascular obstruction or platelet secretion of vasoconstricting neurohumoral agents such as serotonin. Release of vasoactive mediators can produce ventilation-perfusion mismatching at sites remote from the embolus, thereby accounting for a potential discordance between a small PE and a large alveolar-arterial  $O_2$  gradient.
2. *Impaired gas exchange* due to increased alveolar dead space from vascular obstruction, hypoxemia from alveolar hypoventilation relative to perfusion in the nonobstructed lung, right-to-left shunting, and impaired carbon monoxide transfer due to loss of gas exchange surface.

3. *Alveolar hyperventilation* due to reflex stimulation of irritant receptors.
4. *Increased airway resistance* due to constriction of airways distal to the bronchi.
5. *Decreased pulmonary compliance* due to lung edema, lung hemorrhage, or loss of surfactant.

### Right Ventricular (RV) Dysfunction

Progressive right heart failure is the usual cause of death from PE. In the International Cooperative Pulmonary Embolism Registry (ICOPER), the presence of RV dysfunction on baseline echocardiography of PE patients who presented with a systolic blood pressure  $>90$  mm Hg was associated with a doubling of the 3-month mortality rate. As pulmonary vascular resistance increases, RV wall tension rises and causes further RV dilatation and dysfunction. RV contraction continues even after the left ventricle (LV) starts relaxing at end-systole. Consequently, the interventricular septum bulges into and compresses an intrinsically normal left ventricle. Diastolic LV impairment develops, attributable to septal displacement, and results in reduced LV distensibility and impaired LV filling during diastole. Increased RV wall tension also compresses the right coronary artery, diminishes subendocardial perfusion, limits myocardial oxygen supply, and may precipitate myocardial ischemia and RV infarction. Underfilling of the LV may lead to a fall in left ventricular cardiac output and systemic arterial pressure, thereby provoking myocardial ischemia due to compromised coronary artery perfusion. Eventually, circulatory collapse and death may ensue.

## DIAGNOSIS

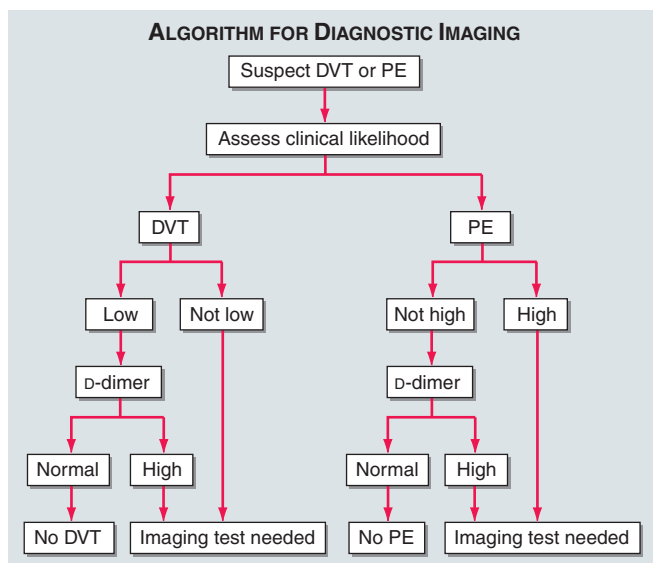
### Clinical Evaluation

The diagnosis is challenging because symptoms and signs are nonspecific. VTE mimics other illnesses, and PE is known as “The Great Masquerader.”

For patients who have DVT, the most frequent history is a cramp in the lower calf that persists for several days and that becomes more uncomfortable as time progresses. For patients who have PE, the most frequent history is unexplained breathlessness.

When evaluating patients with possible DVT, the initial task is to decide whether the clinical likelihood for DVT is low. When evaluating possible PE, the initial task is to decide whether the clinical likelihood is high. Patients with low likelihood of DVT or non-high (i.e., low/moderate) likelihood of PE can undergo initial diagnostic evaluation with D-dimer testing alone (see later) without obligatory imaging tests (Fig. 21-1).

Point score methods are useful for estimating the clinical likelihood of DVT and PE (Table 21-1).



**FIGURE 21-1**  
How to decide whether diagnostic imaging is needed. For assessment of clinical likelihood, see Table 21-1.

### Clinical Syndromes

The differential diagnosis is critical because not all leg pain is due to DVT and not all dyspnea is due to PE (Table 21-2). Sudden, severe calf discomfort suggests a ruptured Baker's cyst. Fever and chills usually herald cellulitis rather than DVT, although DVT may be present concomitantly. Physical findings, if present at all, may

**TABLE 21-1**

#### CLINICAL DECISION RULES

##### LOW CLINICAL LIKELIHOOD OF DVT IF THE POINT SCORE IS ZERO OR LESS

Clinical Variable	Score
Active cancer	1
Paralysis, paresis, or recent cast	1
Bedridden for >3 days; major surgery <12 weeks	1
Tenderness along distribution of deep veins	1
Entire leg swelling	1
Unilateral calf swelling >3 cm	1
Pitting edema	1
Collateral superficial nonvaricose veins	1
Alternative diagnosis at least as likely as DVT	-2

##### HIGH CLINICAL LIKELIHOOD OF PE IF THE POINT SCORE >4

Clinical Variable	Score
Signs and symptoms of DVT	3.0
Alternative diagnosis less likely than PE	3.0
Heart rate >100/min	1.5
Immobilization >3 days; surgery within 4 weeks	1.5
Prior PE or DVT	1.5
Hemoptysis	1.0
Cancer	1.0

**TABLE 21-2**

#### DIFFERENTIAL DIAGNOSIS

DVT
Ruptured Baker's cyst
Cellulitis
Postphlebotic syndrome/venous insufficiency
PE
Pneumonia, asthma, chronic obstructive pulmonary disease
Congestive heart failure
Pericarditis
Pleurisy: "viral syndrome," costochondritis, musculoskeletal discomfort
Rib fracture, pneumothorax
Acute coronary syndrome
Anxiety

simply consist of mild palpation discomfort in the lower calf. Massive DVT is much easier to recognize. The patient presents with severe thigh swelling and marked tenderness when palpating the inguinal area and common femoral vein. In extreme cases, patients are unable to walk or may require a cane, crutches, or a walker.

If the leg is diffusely edematous, DVT is unlikely. Much more common is an acute exacerbation of venous insufficiency due to postphlebotic syndrome. Upper extremity venous thrombosis may present with asymmetry in the supraclavicular fossa or in the circumference of the upper arms. A prominent superficial venous pattern may be evident on the anterior chest wall.

Patients with *massive PE* present with systemic arterial hypotension and usually have anatomically widespread thromboembolism. Those with *moderate to large PE* have RV hypokinesis on echocardiography but normal systemic arterial pressure. Patients with *small to moderate PE* have both normal right heart function and normal systemic arterial pressure. They have an excellent prognosis with adequate anticoagulation.

The presence of *pulmonary infarction* usually indicates a small PE, but one that is exquisitely painful, because it lodges peripherally, near the innervation of pleural nerves. Pleuritic chest pain is more common with small peripheral emboli. However, larger, more central PEs can occur concomitantly with peripheral pulmonary infarction.

*Nonthrombotic PE* may be easily overlooked. Possible etiologies include fat embolism after blunt trauma and long bone fractures, tumor embolism, bone marrow, or air embolism. Cement embolism and bony fragment embolism can occur after total hip or knee replacement. Intravenous drug users may inject themselves with a wide array of substances, such as hair, talc, or cotton. *Amniotic fluid embolism* occurs when fetal membranes leak or tear at the placental margin. Pulmonary edema in this syndrome is probably due to alveolar capillary leakage.



Dyspnea is the most frequent symptom of PE, and tachypnea is its most frequent sign. Whereas dyspnea, syncope, hypotension, or cyanosis indicates a massive PE, pleuritic pain, cough, or hemoptysis often suggests a small embolism located distally near the pleura. On physical examination, young and previously healthy individuals may appear anxious but otherwise seem deceptively well, even with an anatomically large PE. They may only have dyspnea with moderate exertion. They often lack “classic” signs such as tachycardia, low-grade fever, neck vein distension, or an accentuated pulmonary component of the second heart sound. Sometimes paradoxical bradycardia occurs.

Some patients have occult PE and an overt coexisting illness such as pneumonia or heart failure. In such circumstances, clinical improvement often fails to occur despite standard medical treatment of the concomitant illness. This situation can serve as a clinical clue to the possible coexistence of PE.

### Nonimaging Diagnostic Modalities

Nonimaging tests are best utilized in combination with clinical likelihood of DVT or PE (Fig. 21-1).

#### Blood Tests

The quantitative *plasma D-dimer enzyme-linked immunosorbent assay (ELISA)* rises in the presence of DVT or PE because of plasmin’s breakdown of fibrin. Elevation of D-dimer indicates endogenous although often clinically ineffective thrombolysis. The sensitivity of the D-dimer is >80% for DVT (including isolated calf DVT) and >95% for PE. The D-dimer is less sensitive for DVT than PE because the DVT thrombus size is smaller. The D-dimer is a useful “rule-out” test. It is normal (<500 ng/mL) in >95% of patients without PE. In patients with low clinical suspicion of DVT, it is normal in >90% without DVT.

The D-dimer assay is not specific. Levels increase in patients with myocardial infarction, pneumonia, sepsis, cancer, the postoperative state, and second or third trimester of pregnancy. Therefore, it rarely has a useful role among hospitalized patients because their D-dimers are frequently elevated due to some systemic illness.

Contrary to classic teaching, *arterial blood gases* lack diagnostic utility for PE, even though both the PO<sub>2</sub> and PCO<sub>2</sub> often decrease. Among patients suspected of PE, neither the room air arterial PO<sub>2</sub> nor calculation of the alveolar-arterial O<sub>2</sub> gradient can reliably differentiate or triage patients who actually have PE at angiography.

#### Elevated Cardiac Biomarkers

Serum troponin levels increase in RV microinfarction. Myocardial stretch often results in elevation of brain natriuretic peptide or NT-pro-brain natriuretic peptide. Elevated cardiac biomarkers predict an increase in major complications and mortality from PE.

**TABLE 21-3**

### ULTRASONOGRAPHY OF THE DEEP LEG VEINS

#### Criteria for Establishing the Diagnosis of Acute DVT

Lack of vein compressibility (the principal criterion)  
Vein does not “wink” when gently compressed in cross section  
Failure to appose the walls of the vein due to passive distension

#### Direct Visualization of Thrombus

Homogenous  
Low echogenicity

#### Abnormal Doppler Flow Dynamics

Normal response: calf compression augments Doppler flow signal and confirms vein patency proximal and distal to Doppler  
Abnormal response: flow blunted rather than augmented with calf compression

#### Electrocardiogram

The most cited abnormality, in addition to sinus tachycardia, is the S1Q3T3 sign: an S wave in lead I, Q wave in lead III, and inverted T wave in lead III. This finding is relatively specific but insensitive. Perhaps the most frequent abnormality is T-wave inversion in leads V<sub>1</sub> to V<sub>4</sub>.

### Noninvasive Imaging Modalities

#### Venous Ultrasonography

Ultrasonography of the deep venous system (Table 21-3) relies on loss of vein compressibility as the primary criterion for DVT. When a normal vein is imaged in cross section, it readily collapses with gentle manual pressure from the ultrasound transducer. This creates the illusion of a “wink.” With acute DVT, the vein loses its compressibility because of passive distension by acute thrombus. The diagnosis of acute DVT is even more secure when thrombus is directly visualized. It appears homogeneous and has low echogenicity (Fig. 21-2). The vein itself often appears mildly dilated, and collateral channels may be absent.

Venous flow dynamics can be examined with Doppler imaging. Normally, manual calf compression causes augmentation of the Doppler flow pattern. Loss of normal respiratory variation is caused by obstructing DVT or by any obstructive process within the pelvis. Because DVT and PE are so closely related and are both treated with anticoagulation (see later), confirmed DVT is usually an adequate surrogate for PE. In contrast, a normal venous ultrasound does not exclude PE. Most patients with PE have no imaging evidence of DVT, probably because the clot has already embolized to the lung or is in the pelvic veins, where ultrasonography is usually inadequate. In patients without DVT, the ultrasound examination may identify other reasons for leg discomfort such as a

**FIGURE 21-2**

**Acute DVT on venous ultrasound examination.** The vein is not compressible and thrombus (*far left arrow*) is visualized directly in the deep venous system. SFV, superficial femoral vein (which is a deep vein, despite the terminology “superficial”); DFV, deep femoral vein (synonymous with profunda femoral vein). (*From the personal collection of Samuel Z. Goldhaber, MD; with permission.*)

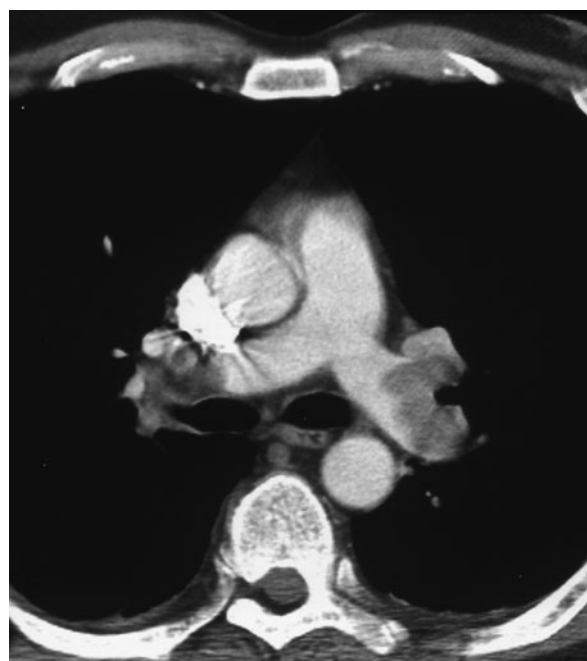
Baker’s cyst (also known as a popliteal or synovial cyst) or a hematoma. For patients with a technically poor or nondiagnostic venous ultrasound, consider alternative imaging modalities for DVT such as CT or magnetic resonance imaging.

### Chest Roentgenography

A normal or near-normal chest x-ray in a dyspneic patient often occurs in PE. Well-established abnormalities include focal oligemia (Westermark’s sign), a peripheral wedged-shaped density above the diaphragm (Hampton’s hump), or an enlarged right descending pulmonary artery (Palla’s sign).

### Chest CT

Computed tomography (CT) of the chest with intravenous contrast is the principal imaging test for the diagnosis of PE (**Fig. 21-3**). Multidetector-row spiral CT acquires all chest images with  $\leq 1$  mm resolution during a short breath hold. This generation of CT scanners can image small peripheral emboli. Sixth-order branches can be visualized with resolution superior to conventional invasive contrast pulmonary angiography. The CT scan also obtains excellent images of the RV and LV and can be used for a risk stratification as well as a diagnostic tool. In patients with PE, RV enlargement on chest CT indicates a fivefold increased likelihood of

**FIGURE 21-3**

**Large bilateral proximal PE** on chest CT following radical prostatectomy.

death within the next 30 days compared with PE patients with normal RV size on chest CT. When imaging is continued below the chest to the knee, pelvic and proximal leg DVT can also be diagnosed by CT scanning. In patients without PE, the lung parenchymal images may establish alternative diagnoses not apparent on chest x-ray that explain the presenting symptoms and signs, such as pneumonia, emphysema, pulmonary fibrosis, pulmonary mass, or aortic pathology. Sometimes asymptomatic early stage lung cancer is diagnosed incidentally.

### Lung Scanning

Lung scanning is now a second-line diagnostic test for PE. It is mostly used for patients who cannot tolerate IV contrast. Small particulate aggregates of albumin labeled with a gamma-emitting radionuclide are injected intravenously and are trapped in the pulmonary capillary bed. The perfusion scan defect indicates absent or decreased blood flow, possibly due to PE. Ventilation scans, obtained with radiolabeled inhaled gases such as xenon or krypton, improve the specificity of the perfusion scan. Abnormal ventilation scans indicate abnormal nonventilated lung, thereby providing possible explanations for perfusion defects other than acute PE, such as asthma or chronic obstructive pulmonary disease. A high probability scan for PE is defined as having two or more segmental perfusion defects in the presence of normal ventilation.

The diagnosis of PE is very unlikely in patients with normal and near-normal scans but is  $\sim 90\%$  certain in

258 patients with high-probability scans. Unfortunately, most patients have nondiagnostic scans, and fewer than half of patients with angiographically confirmed PE have a high-probability scan. As many as 40% of patients with high clinical suspicion for PE and “low-probability” scans do, in fact, have PE at angiography.

### Magnetic Resonance (MR) (Contrast-Enhanced)

When ultrasound is equivocal, MR venography is an excellent imaging modality to diagnose DVT. MR uses gadolinium contrast agent, which, unlike iodinated contrast agents used in venography or CT angiography, is not nephrotoxic. MR imaging should be considered for suspected DVT or PE patients with renal insufficiency or contrast dye allergy. MR pulmonary angiography detects large proximal PE but is not reliable for smaller segmental and subsegmental PE.

### Echocardiography

Echocardiography is *not* a reliable diagnostic imaging tool for acute PE because most patients with PE have normal echocardiograms. However, echocardiography is a very useful diagnostic tool for detecting conditions that might mimic PE, such as acute myocardial infarction, pericardial tamponade, or aortic dissection.

Transthoracic echocardiography rarely images thrombus directly. The best known indirect sign of PE on transthoracic echocardiography is McConnell’s sign, hypokinesis of the RV free wall with normal motion of the RV apex.

Transesophageal echocardiography should be considered when CT scanning facilities are not available or when a patient has renal failure or severe contrast allergy that precludes administration of contrast despite premedication with high-dose steroids. This imaging modality can directly visualize large proximal PE.

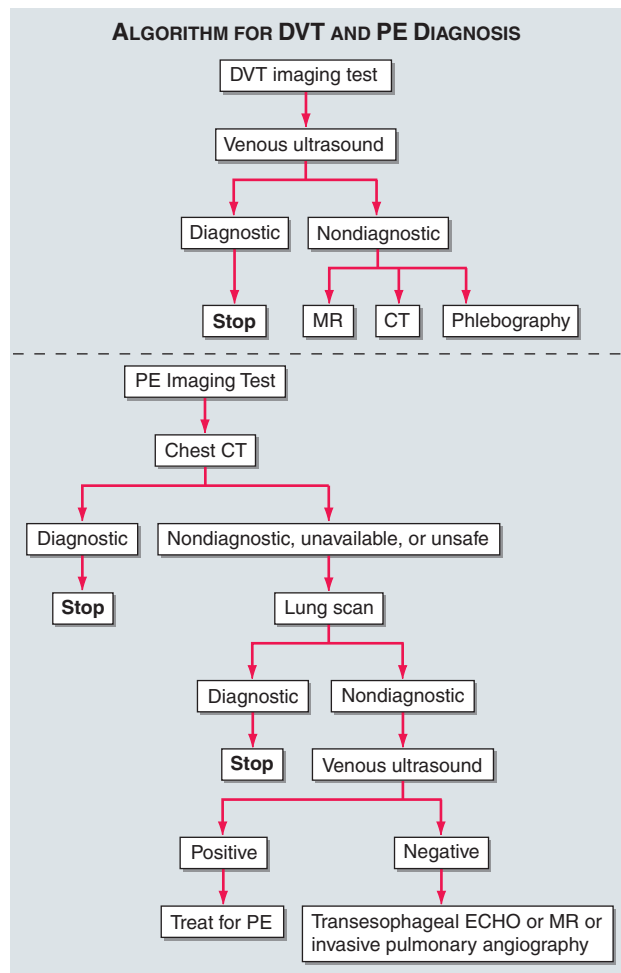
### Invasive Diagnostic Modalities

#### Pulmonary Angiography

Chest CT with contrast (see earlier) has virtually replaced invasive pulmonary angiography as a diagnostic test. Invasive catheter-based diagnostic testing is reserved for patients with technically unsatisfactory chest CTs or for those in whom an interventional procedure such as catheter-directed thrombolysis or embolectomy is planned. A definitive diagnosis of PE depends on visualization of an intraluminal filling defect in more than one projection. Secondary signs of PE include abrupt occlusion (“cutoff”) of vessels, segmental oligemia or avascularity, a prolonged arterial phase with slow filling, or tortuous, tapering peripheral vessels.

#### Contrast Phlebography

Venous ultrasonography has virtually replaced contrast phlebography as the diagnostic test for suspected DVT.



**FIGURE 21-4**  
Imaging tests to diagnose DVT and PE.

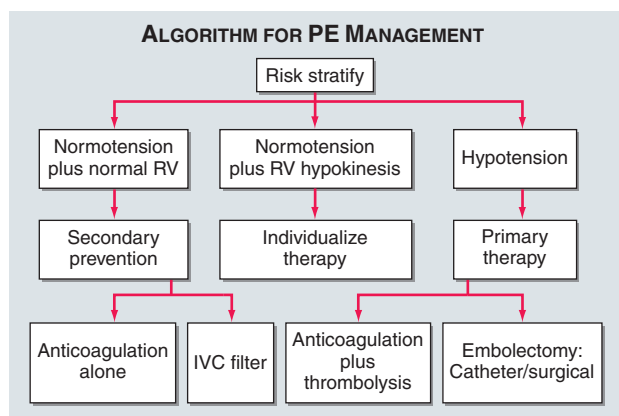
### Integrated Diagnostic Approach

An integrated diagnostic approach (Fig. 21-1) streamlines the workup of suspected DVT and PE (Fig. 21-4).

### Rx Treatment: DEEP VEIN THROMBOSIS

**PRIMARY THERAPY VERSUS SECONDARY PREVENTION** *Primary therapy* consists of clot dissolution with thrombolysis or removal of PE by embolectomy. Anticoagulation with heparin and warfarin or placement of an inferior vena caval filter constitutes *secondary prevention* of recurrent PE rather than primary therapy.

**RISK STRATIFICATION** Rapid and accurate risk stratification is critical in determining optimal treatment strategy. The presence of hemodynamic instability, RV dysfunction, or elevation of the troponin level due to RV microinfarction can identify high-risk patients. Detection of RV hypokinesis on echocardiography is the most widely used approach to risk stratification. However, RV

**FIGURE 21-5**

**Acute management of pulmonary thromboembolism.** RV, right ventricular; IVC, inferior vena cava.

enlargement on chest CT also predicts an increased mortality rate from PE. The combination of RV dysfunction plus elevated biomarkers such as troponin portends an especially ominous prognosis.

Primary therapy should be reserved for patients at high risk of an adverse clinical outcome. When RV function remains normal in a hemodynamically stable patient, a good clinical outcome is highly likely with anticoagulation alone (Fig. 21-5).

## **Rx Treatment:** **MASSIVE PULMONARY EMBOLISM**

**ANTICOAGULATION** Anticoagulation is the foundation for successful treatment of DVT and PE (Table 21-4). Immediately effective anticoagulation is initiated with a parenteral drug: unfractionated heparin (UFH), low-molecular-weight heparin (LMWH), or fondaparinux. These parenteral drugs (see later) are continued as a transition or “bridge” to stable, long-term anticoagulation with a vitamin K antagonist (exclusively warfarin in the United States). The first dose of warfarin may be given as soon as several hours after the bridging anticoagulant if LMWH or fondaparinux are used. Otherwise, with UFH a therapeutic aPTT must first be documented. Warfarin requires 5–7 days to achieve a therapeutic effect. During that period, the parenteral and oral agents are overlapped. After 5–7 days of anticoagulation, residual thrombus begins to become endothelialized in the vein or pulmonary artery. However, anticoagulants do not directly dissolve thrombus that already exists.

**Unfractionated Heparin** Unfractionated heparin (UFH) anticoagulates by binding to and accelerating the activity of antithrombin III, thus preventing additional thrombus formation and permitting endogenous fibrinolytic mechanisms to lyse clot that has already formed.

**TABLE 21-4**

### ANTICOAGULATION OF VTE

#### Immediate Parenteral Anticoagulation

Unfractionated heparin, bolus and continuous infusion, to achieve aPTT 2–3 times the upper limit of the laboratory normal, or  
 Enoxaparin, 1 mg/kg twice daily, with normal renal function, or  
 Tinzaparin, 175 U/kg once daily, with normal renal function, or  
 Fondaparinux, weight based once daily; adjust for impaired renal function

#### Warfarin Anticoagulation

Usual start dose is 5–10 mg.  
 Titrate to INR, target 2.0–3.0.  
 Continue parenteral anticoagulation for a minimum of 5 days and until two sequential INR values, at least 1 day apart, return in the target range.

UFH is dosed to achieve a target activated partial thromboplastin time (aPTT) that is two to three times the upper limit of the laboratory normal. This is usually equivalent to an aPTT of 60–80 s. For UFH, a typical intravenous bolus is 5000–10,000 U followed by a continuous infusion of 1000–1500 U/h. Nomograms based on a patient’s weight may assist in adjusting the dose of heparin. The most popular nomogram uses an initial bolus of 80 U/kg, followed by an initial infusion rate of 18 U/kg per hour.

The major advantage of UFH is that it has a short half-life. Its anticoagulant effect abates after several hours. This is especially useful if the patient will undergo an invasive procedure such as surgical embolectomy.

The major disadvantage of UFH is that achieving the target aPTT can be difficult and may require repeated blood sampling and heparin dose adjustment every 4–6 h. Furthermore, by using UFH, patients are at risk of developing heparin-induced thrombocytopenia.

**Low-Molecular-Weight Heparins** These fragments of UFH exhibit less binding to plasma proteins and endothelial cells and consequently have greater bioavailability, a more predictable dose response, and a longer half-life than UFH. No monitoring or dose adjustment is needed unless the patient is markedly obese or has renal insufficiency.

*Enoxaparin*, 1 mg/kg twice daily, and *tinzaparin*, 175 U/kg once daily, have received U.S. Food and Drug Administration (FDA) approval for treatment of patients who present with DVT. The weight-adjusted doses must be adjusted downward in renal insufficiency because the kidneys excrete LMWH.

**Fondaparinux** Fondaparinux, an anti-Xa pentasaccharide, is administered by once-daily subcutaneous

injection and has been approved by the FDA to treat DVT and PE. No laboratory monitoring is required. Patients weighing <50 kg receive 5 mg, 50–100 kg patients receive 7.5 mg, and patients weighing >100 kg receive 10 mg. The dose must be adjusted downward for patients with renal dysfunction because the drug is excreted by the kidneys.

**Warfarin** This vitamin K antagonist prevents carboxylation activation of coagulation factors II, VII, IX, and X. The full effect of warfarin requires at least 5 days, even if the prothrombin time, used for monitoring, becomes elevated more rapidly. If warfarin is initiated as monotherapy during an acute thrombotic illness, a paradoxical exacerbation of hypercoagulability can increase the likelihood of thrombosis rather than prevent it. Overlapping UFH, LMWH, or fondaparinux with warfarin for at least 5 days can counteract the early procoagulant effect of unopposed warfarin.

**Dosing** In an average-sized adult, warfarin is usually initiated in a dose of 5 mg. Doses of 7.5 or 10 mg can be used in obese or large-framed young patients who are otherwise healthy. Patients who are malnourished or who have received prolonged courses of antibiotics are probably deficient in vitamin K and should receive smaller initial doses of warfarin, such as 2.5 mg. The prothrombin time is standardized with the INR, which assesses the anticoagulant effect of warfarin (Chap. 3). The target INR is usually 2.5, with a range of 2.0–3.0.

The warfarin dose is titrated to achieve the target INR. Proper dosing is difficult because hundreds of drug-drug and drug-food interactions affect warfarin metabolism. Furthermore, variables such as increasing age and comorbidities such as systemic illness, malabsorption, and diarrhea reduce the warfarin-dosing requirement.

No reliable nomogram has been established to predict how individual patients will respond to warfarin. Therefore, dosing is adjusted according to an “educated guess.” Centralized anticoagulation clinics have improved the efficacy and safety of warfarin dosing. Based on a meta-analysis of trials comparing anticoagulation clinic care versus self-monitoring, patients benefit if they can self-monitor their INR with a home point-of-care fingerstick machine. The subgroup with the best results also learns to self-adjust warfarin doses.

Pharmacogenomics may provide the gateway to rational dosing of warfarin. A recent discovery is that five polymorphisms of the vitamin K receptor gene explain 25% of the variance in warfarin dosing. These polymorphisms can stratify patients into low-, intermediate-, and high-dose warfarin groups. An additional 10% of dosing variance can be explained by allelic variants of the cytochrome P-450 enzyme 2C9. These mutations decrease warfarin dosing because they impair the metabolism of the S-enantiomer of warfarin. In the

future, if rapid turnaround of genetic testing becomes possible, warfarin could be dosed according to specific pharmacogenomic profiles.

**Complications of Anticoagulants** The most important adverse effect of anticoagulation is hemorrhage. For life-threatening or intracranial hemorrhage due to heparin or LMWH, protamine sulfate can be administered. There is no specific antidote for bleeding from fondaparinux.

Major bleeding from warfarin is traditionally managed with cryoprecipitate or fresh-frozen plasma (usually 2–4 U) to achieve rapid hemostasis. Recombinant human coagulation factor VIIa (rFVIIa), FDA-approved for bleeding in hemophiliacs, is widely used off-label to manage catastrophic bleeding from warfarin. The optimal dose appears to be 40 µg/kg. The greatest risk of this therapy is rebound thromboembolism. For minor bleeding, or to manage an excessively high INR in the absence of bleeding, a small 2.5 mg dose of oral vitamin K may be administered.

Heparin-induced thrombocytopenia (HIT) and osteopenia are far less common with LMWH than with UFH. Thrombosis due to HIT should be managed with a direct thrombin inhibitor: argatroban for patients with renal insufficiency or lepirudin for patients with hepatic failure. In the setting of percutaneous coronary intervention, administer bivalirudin.

The most common nonbleeding side effect of warfarin is alopecia. A rare complication is warfarin-induced skin necrosis, which may be related to warfarin-induced reduction of protein C.

During pregnancy, warfarin should be avoided if possible because of warfarin embryopathy, which is most common with exposure during the 6th through 12th week of gestation. However, women can take warfarin postpartum and breast-feed safely. Warfarin can also be administered safely during the second trimester.

**Duration of Hospital Stay** Acute DVT patients with good family and social support, permanent residence, telephone, and no hearing or language impairment can often be managed as outpatients. They or a family member or a visiting nurse can administer a parenteral anticoagulant. Warfarin dosing can be titrated to the INR and adjusted on an outpatient basis.

Acute PE patients, who traditionally have required 5- to 7-day hospital stays for intravenous heparin as a “bridge” to warfarin, can be considered for abbreviated hospitalization if they have an excellent prognosis. The latter are characterized by clinical stability, absence of chest pain or shortness of breath, normal right ventricular size and function, and normal levels of cardiac biomarkers.

**Duration of Anticoagulation** Patients with PE following surgery or trauma ordinarily have a low rate of

recurrence after 3–6 months of anticoagulation. For DVT isolated to an upper extremity or calf that has been provoked by surgery or trauma, 3 months of anticoagulation suffices. For provoked proximal leg DVT or PE, 6 months of anticoagulation is sufficient.

However, among patients with “idiopathic,” unprovoked DVT or PE, the recurrence rate is surprisingly high after cessation of anticoagulation. VTE that occurs during long-haul air travel is considered unprovoked.

Current American College of Chest Physicians (ACCP) guidelines recommend anticoagulation for an indefinite duration with a target INR between 2.0 and 3.0 for patients with idiopathic VTE. However, I recommend that the intensity of anticoagulation be tailored to the patient’s risk of recurrent VTE versus risk of bleeding. For a patient at high risk of recurrent VTE (e.g., someone with multiple thrombophilic disorders) and a low risk of bleeding (e.g., young age and no comorbidities), I recommend standard intensity anticoagulation. However, for a patient with a high bleeding risk (e.g., older age and a prior history of gastrointestinal bleeding), I advise low-intensity anticoagulation (INR 1.5–2.0) after 6 months.

Several years ago, the presence of genetic mutations such as factor V Leiden or prothrombin gene mutation was thought to markedly increase the risk of recurrent VTE. Now, however, the clinical circumstances in which the DVT or PE occurs rather than underlying thrombophilia are considered much more important in deciding the risk of recurrence and the optimal duration of anticoagulation. However, patients with moderate or high levels of anticardiolipin antibodies probably warrant indefinite duration anticoagulation, even if the initial VTE was provoked by trauma or surgery.

**INFERIOR VENA CAVAL (IVC) FILTERS** The two principal indications for insertion of an IVC filter are (1) active bleeding that precludes anticoagulation, and (2) recurrent venous thrombosis despite intensive anticoagulation. Prevention of recurrent PE in patients with right heart failure who are not candidates for fibrinolysis or prophylaxis of extremely high-risk patients are “softer” indications for filter placement. The filter itself may fail by permitting the passage of small to medium-sized clots. Large thrombi may embolize to the pulmonary arteries via collateral veins that develop. A more common complication is caval thrombosis with marked bilateral leg swelling.

Paradoxically, by providing a nidus for clot formation, filters double the DVT rate over the ensuing 2 years following placement. Therefore, if clinically safe, patients receiving IVC filters should also receive concomitant anticoagulation.

Retrievable filters can now be placed for patients with an anticipated temporary bleeding disorder or for

patients at temporary high risk of PE, such as individuals undergoing bariatric surgery with a prior history of perioperative PE. The filters can be retrieved up to several months following insertion, unless thrombus forms and is trapped within the filter. The retrievable filter becomes permanent if it remains in place or if, for technical reasons such as rapid endothelialization, it cannot be removed.

**MAINTAINING ADEQUATE CIRCULATION** For patients with massive PE and hypotension, the most common initial approach is administration of 500–1,000 mL of normal saline. However, fluids should be used with extreme caution. Excessive fluid administration exacerbates RV wall stress, causes more profound RV ischemia, and worsens LV compliance and filling by causing further interventricular septal shift toward the LV. Dopamine and dobutamine are first-line inotropic agents for treatment of PE-related shock. There should be a low threshold to initiate these pressors. However, a “trial and error” approach may be necessary with other agents such as norepinephrine, vasopressin, or phenylephrine.

**FIBRINOLYSIS** Successful fibrinolytic therapy rapidly reverses right heart failure and leads to a lower rate of death and recurrent PE. Thrombolysis usually (1) dissolves much of the anatomically obstructing pulmonary arterial thrombus; (2) prevents the continued release of serotonin and other neurohumoral factors that exacerbate pulmonary hypertension; and (3) dissolves much of the source of the thrombus in the pelvic or deep leg veins, thereby decreasing the likelihood of recurrent PE.

The preferred fibrinolytic regimen is 100 mg of recombinant tissue plasminogen activator (tPA) administered as a continuous peripheral intravenous infusion over 2 h. Patients appear to respond to fibrinolysis for up to 14 days after the PE has occurred.

Contraindications to fibrinolysis include intracranial disease, recent surgery, or trauma. The overall major bleeding rate is ~10%, including a 1–3% risk of intracranial hemorrhage. Careful screening of patients for contraindications to fibrinolytic therapy is the best way to minimize bleeding risk.

The only FDA-approved indication for PE fibrinolysis is massive PE. For patients with preserved systolic blood pressure and submassive PE, guidelines recommend individual patient risk assessment of the thrombotic burden versus bleeding risk. I concur with these guidelines. Younger patients with submassive PE but without comorbidities are generally excellent candidates for fibrinolysis. For older patients (>70 years of age) with risk of intracranial hemorrhage, a “watch and wait” approach is suitable, with frequent serial evaluation of RV function by echocardiography; fibrinolysis should be considered in those with deterioration of RV function.

**PULMONARY EMBOLLECTOMY** The risk of intracranial hemorrhage with fibrinolysis has prompted the renaissance of surgical embolectomy for acute PE. At Brigham and Women's Hospital, 47 patients with massive PE underwent emergency surgery in 53 months, with a 94% survival rate. This high survival rate may be attributed to improved surgical technique, rapid diagnosis and triage, and careful patient selection. A possible alternative to open surgical embolectomy is catheter embolectomy. New generation catheters are under development.

**PULMONARY THROMBOENDARTERECTOMY** Chronic thromboembolic pulmonary hypertension is caused by vascular obstruction at the capillary level, not direct thromboembolic occlusion. It used to be considered a rare complication (~1 of 500) of acute PE. Now, however, it appears that chronic thromboembolic pulmonary hypertension is a more common development, occurring in ~4% of patients who develop acute PE. Therefore, PE patients should be followed to ensure that if they have initial pulmonary hypertension, it abates over time (usually 6 weeks).

Patients severely impaired with dyspnea due to chronic thromboembolic pulmonary hypertension should be considered for pulmonary thromboendarterectomy, which, if successful, can markedly reduce and at times even cure pulmonary hypertension. The operation requires median sternotomy, cardiopulmonary bypass, deep hypothermia, and periods of hypothermic circulatory arrest. The fibrotic, thromboembolic material is grasped with a forceps and circumferentially dissected from the vessel wall. The mortality rate at experienced centers is ~5%. The two most common complications are (1) "pulmonary steal," where blood rushes from previously perfused areas to newly revascularized areas of the lung; and (2) reperfusion pulmonary edema.

**EMOTIONAL SUPPORT** Many patients with VTE appear healthy and fit. They may be burdened with fear about the possible genetic implications of DVT or PE. They often feel overwhelmed when advised to continue lifelong anticoagulation. Many patients in whom anticoagulation is discontinued after 3–6 months of therapy feel vulnerable to a future recurrent VTE. They may be reluctant to discontinue warfarin. Support groups are useful. Responses to frequently asked questions by these patients have been posted on the following website: <http://web.mit.edu/karen/www/faq.html>.

**PREVENTION OF POSTPHLEBITIC SYNDROME** The only therapy to prevent postphlebitic syndrome is daily use of below-knee 30–40 mm Hg vascular compression stockings. They halve the rate of developing postphlebitic syndrome. These vascular compression stockings should be prescribed as soon as DVT is

diagnosed, and the stockings should be fitted carefully to maximize their benefit. When patients are in bed, the stockings need not be worn.

## PREVENTION OF VTE

Prophylaxis is of paramount importance because VTE is difficult to detect and poses an excessive medical and economic burden. Mechanical and pharmacologic measures often succeed in preventing this complication (Table 21-5). Patients at high risk can receive a combination of mechanical and pharmacologic modalities. Graduated compression stockings and pneumatic compression devices may complement mini-dose unfractionated heparin (5000 U subcutaneously twice or preferably three times daily), low-molecular-weight heparin, a pentasaccharide (fondaparinux, 2.5 mg daily), or warfarin administration. Computerized reminder systems can increase the use of preventive measures and at Brigham and Women's Hospital reduced the symptomatic VTE rate by >40%. Patients who have undergone total hip replacement, total knee replacement, or cancer surgery will benefit from extended pharmacologic prophylaxis for a total of 4–6 weeks.

**TABLE 21-5**

### PREVENTION OF VENOUS THROMBOEMBOLISM

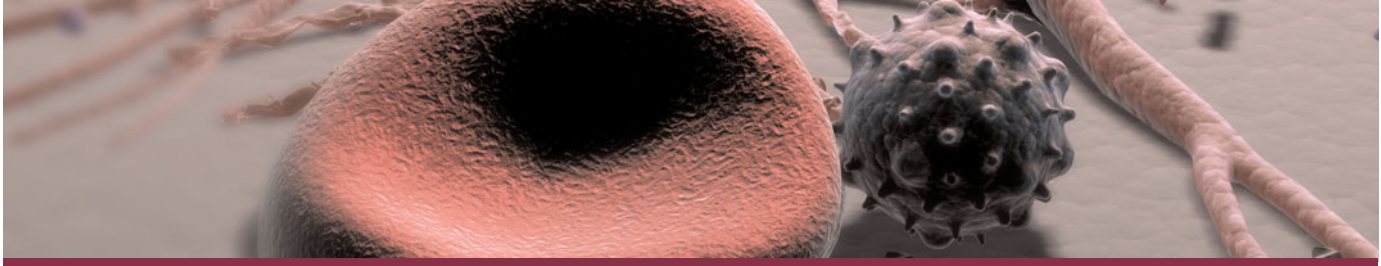
CONDITION	PROPHYLAXIS STRATEGY
High-risk general surgery	Mini-UFH + GCS or LMWH + GCS
Thoracic surgery	Mini-UFH + IPC
Cancer surgery, including gynecologic cancer surgery	LMWH, consider 1 month of prophylaxis
Total hip replacement, total knee replacement, hip fracture surgery	LMWH, fondaparinux (a pentasaccharide) 2.5 mg sc, once daily or (except for total knee replacement) warfarin (target INR: 2.5)
Neurosurgery	GCS + IPC
Neurosurgery for brain tumor	Mini-UFH or LMWH, + IPC, + pre-discharge venous ultrasonography
Benign gynecologic surgery	Mini-UFH + GCS
Medically ill patients	Mini-UFH or LMWH
Anticoagulation contraindicated	GCS + IPC
Long-haul air travel	Consider LMWH for very high risk patients

**Note:** Mini-UFH, minidose unfractionated heparin, 5000 U subcutaneously twice (less effective) or three times daily (more effective); GCS, graduated compression stockings, usually 10–18 mm Hg; LMWH, low-molecular-weight heparin, typically in the United States, enoxaparin, 40 mg once daily, or dalteparin, 2500 or 5000 U once daily; IPC, intermittent pneumatic compression devices.

## FURTHER READINGS

- BLAIVAS M: Ultrasound in the detection of venous thromboembolism. *Crit Care Med* 35:S224, 2007
- DONG BR et al: Thrombolytic therapy for pulmonary embolism. *Cochrane Database Syst Rev* CD004437, 2009
- FIUMARA K et al: Predictors of major hemorrhage following fibrinolysis for acute pulmonary embolism. *Am J Cardiol* 97:127, 2006
- GEERTS WH et al: Prevention of venous thromboembolism: The Seventh ACCP Conference on Antithrombotic and Thrombolytic Therapy. *Chest* 126:338S, 2004
- HILL J, TREASURE T: Reducing the risk of venous thromboembolism (deep vein thrombosis and pulmonary embolism) in patients having surgery: Summary of NICE guidance. *BMJ* 334:1053, 2007
- KUCHER N et al: Electronic alerts to prevent venous thromboembolism among hospitalized patients. *N Engl J Med* 352:969, 2005
- et al: Prognostic role of echocardiography among patients with acute pulmonary embolism and a systolic arterial pressure of 90 mm Hg or higher. *Arch Intern Med* 165:1777, 2005
- et al: Percutaneous catheter thrombectomy device for acute pulmonary embolism: In vitro and in vivo testing. *Radiology* 236:852, 2005
- KUCHER N, GOLDHABER SZ: Management of massive pulmonary embolism. *Circulation* 112:e28, 2005
- LEACCHE M et al: Modern surgical treatment of massive pulmonary embolism: Results in 47 consecutive patients after rapid diagnosis and aggressive surgical approach. *J Thorac Cardiovasc Surg* 129:1018, 2005
- MASOTTI L et al: Prognostic stratification of acute pulmonary embolism: Focus on clinical aspects, imaging, and biomarkers. *Vasc Health Risk Manag* 5:567, 2009
- RIDKER P et al: Long-term, low-intensity warfarin therapy for the prevention of recurrent venous thromboembolism. *N Engl J Med* 348:1425, 2003
- RIEDER MJ et al: Effect of VKORC1 haplotypes on transcriptional regulation and warfarin dose. *N Engl J Med* 352:2285, 2005
- SEGAL JB et al: Management of venous thromboembolism: A systematic review for a practice guideline. *Ann Intern Med* 146:211, 2007
- TODD JL, TAPSON VF: Thrombolytic therapy for acute pulmonary embolism: A critical appraisal. *Chest* 135:1321, 2009
- WELLS PS et al: Does this patient have deep vein thrombosis? *JAMA* 295:199, 2006
- WHITE RH, KEENAN CR: Effects of race and ethnicity on the incidence of venous thromboembolism. *Thromb Res* 123 (suppl 4): S11, 2009
- WRITING GROUP FOR THE CHRISTOPHER INVESTIGATORS: Effectiveness of managing suspected pulmonary embolism using an algorithm combining clinical probability, D-dimer testing, and computed tomography. *JAMA* 295:172, 2006





## CHAPTER 22

# ANTIPLATELET, ANTICOAGULANT, AND FIBRINOLYTIC DRUGS

Jeffrey I. Weitz

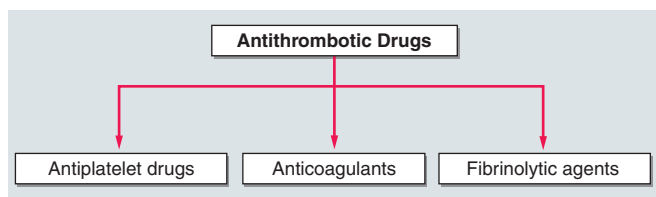
■ Antiplatelet Drugs . . . . .	.265	Role of Fibrinolytic Therapy . . . . .	.279
Role of Platelets in Arterial Thrombosis . . . . .	.265	Mechanism of Action . . . . .	.279
Aspirin . . . . .	.265	Streptokinase . . . . .	.280
Thienopyridines . . . . .	.267	Anistreplase . . . . .	.280
Dipyridamole . . . . .	.267	Urokinase . . . . .	.281
GPIIb/IIIa Receptor Antagonists . . . . .	.268	Alteplase . . . . .	.281
New Antiplatelet Agents . . . . .	.269	Tenecteplase . . . . .	.282
■ Anticoagulants . . . . .	.269	Reteplase . . . . .	.282
Parenteral Anticoagulants . . . . .	.269	New Fibrinolytic Agents . . . . .	.282
Oral Anticoagulants . . . . .	.276	■ Conclusions and Future Directions . . . . .	.282
■ Fibrinolytic Drugs . . . . .	.279	■ Further Readings . . . . .	.282

Arterial and venous thromboses are major causes of morbidity and mortality. Arterial thrombosis is the most common cause of acute myocardial infarction, ischemic stroke, and limb gangrene, whereas deep vein thrombosis leads to pulmonary embolism (PE), which can be fatal, and to the postphlebotic syndrome. Most arterial thrombi are superimposed on disrupted atherosclerotic plaque because plaque rupture exposes thrombogenic material in the plaque core to the blood. This material then triggers platelet aggregation and fibrin formation, which results in the generation of a platelet-rich thrombus that can temporarily or permanently occlude blood flow. In contrast to arterial thrombi, venous thrombi rarely form at sites of obvious vascular disruption. Although they can develop after surgical trauma to veins or secondary to indwelling venous catheters, venous thrombi usually originate in the valve cusps of the deep veins of the calf or in the muscular sinuses, where they are triggered by stasis. Sluggish blood flow in these veins reduces the oxygen supply to the avascular valve cusps. Endothelial cells lining these valve cusps become activated and express adhesion molecules on their surface. Tissue factor-bearing leukocytes and microparticles adhere to these activated cells and induce coagulation. Local thrombus formation

is exacerbated by reduced clearance of activated clotting factors as a result of impaired blood flow. If the thrombi extend into more proximal veins of the leg, thrombus fragments can dislodge, travel to the lungs, and produce a PE.

Arterial and venous thrombi are composed of platelets and fibrin, but the proportions differ. Arterial thrombi are rich in platelets because of the high shear in the injured arteries. In contrast, venous thrombi, which form under low shear conditions, contain relatively few platelets and are predominantly composed of fibrin and trapped red cells. Because of the predominance of platelets, arterial thrombi appear white, whereas venous thrombi are red in color, reflecting the trapped red cells.

Antithrombotic drugs are used for prevention and treatment of thrombosis. Targeting the components of thrombi, these agents include (1) antiplatelet drugs, (2) anticoagulants, and (3) fibrinolytic agents (Fig. 22-1). With the predominance of platelets in arterial thrombi, strategies to inhibit or treat arterial thrombosis focus mainly on antiplatelet agents, although, in the acute setting, they often include anticoagulants and fibrinolytic agents. Anticoagulants are the mainstay of prevention and treatment of venous thromboembolism because



**FIGURE 22-1**  
Classification of antithrombotic drugs.

fibrin is the predominant component of venous thrombi. Antiplatelet drugs are less effective than anticoagulants in this setting because of the limited platelet content of venous thrombi. Fibrinolytic therapy is used in selected patients with venous thromboembolism. For example, patients with massive or submassive PE can benefit from systemic or catheter-directed fibrinolytic therapy. The latter can also be used as an adjunct to anticoagulants for treatment of patients with extensive iliofemoral vein thrombosis.

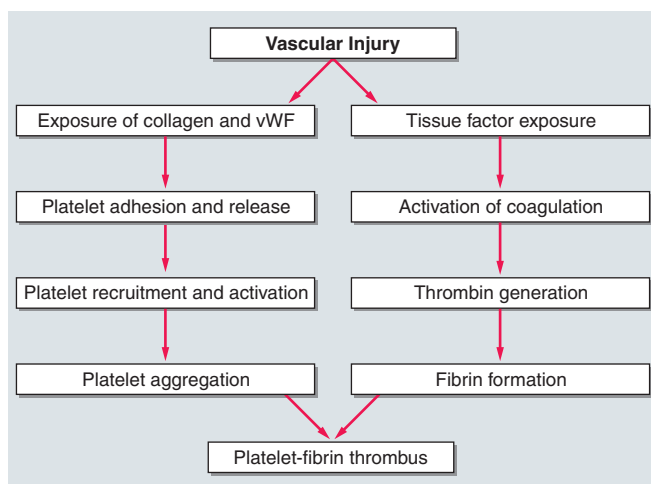
## ANTIPLATELET DRUGS

### ROLE OF PLATELETS IN ARTERIAL THROMBOSIS

In healthy vasculature, circulating platelets are maintained in an inactive state by nitric oxide (NO) and prostacyclin released by endothelial cells lining the blood vessels. In addition, endothelial cells also express adenosine diphosphatase (ADPase) on their surface, which degrades ADP released from activated platelets. When the vessel wall is damaged, release of these substances is impaired and subendothelial matrix is exposed. Platelets adhere to exposed collagen, von Willebrand's factor (vWF), and fibronectin via  $\alpha_2\beta_1$ , glycoprotein (GP) Ib-IX, and  $\alpha_5\beta_1$  receptors, respectively, which are constitutively expressed on the platelet surface. Adherent platelets undergo a change in shape, secrete ADP from their dense granules, and synthesize and release thromboxane  $A_2$ . Released ADP and thromboxane  $A_2$ , which are platelet agonists, activate ambient platelets and recruit them to the site of vascular injury (Fig. 22-2).

Disruption of the vessel wall also exposes tissue factor-expressing cells to the blood. Tissue factor initiates coagulation. Activated platelets potentiate coagulation by binding clotting factors and supporting the assembly of activation complexes that enhance thrombin generation. In addition to converting fibrinogen to fibrin, thrombin also serves as a potent platelet agonist and recruits more platelets to the site of vascular injury.

When platelets are activated, GPIIb/IIIa, the most abundant receptor on the platelet surface, undergoes a conformational change that enables it to bind fibrinogen. Divalent fibrinogen molecules bridge adjacent platelets together to form platelet aggregates. Fibrin strands,



**FIGURE 22-2**  
**Coordinated role of platelets and the coagulation system in thrombogenesis.** Vascular injury simultaneously triggers platelet activation and aggregation and activation of the coagulation system. Platelet activation is initiated by exposure of subendothelial collagen and von Willebrand's factor (vWF) onto which platelets adhere. Adherent platelets become activated and release ADP and thromboxane  $A_2$ , platelet agonists that activate ambient platelets and recruit them to the site of injury. When platelets are activated, glycoprotein IIb/IIIa on their surface undergoes a conformational change that enables it to ligate fibrinogen and mediate platelet aggregation. Coagulation is triggered by tissue factor exposed at the site of injury. Tissue factor triggers thrombin generation. As a potent platelet agonist, thrombin amplifies platelet recruitment to the site of injury. Thrombin also converts fibrinogen to fibrin, and the fibrin strands then weave the platelet aggregates together to form a platelet/fibrin thrombus.

generated through the action of thrombin, then weave these aggregates together to form a platelet/fibrin mesh.

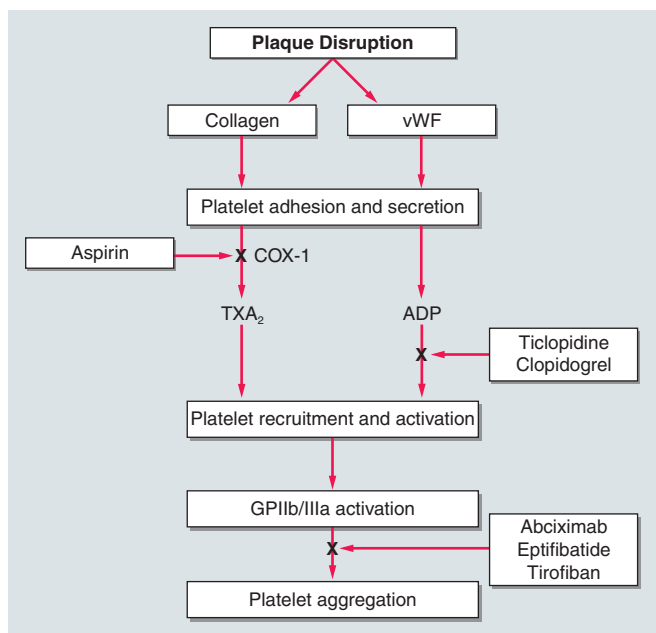
Antiplatelet drugs target various steps in this process. The commonly used drugs include aspirin, thienopyridines (clopidogrel and ticlopidine), dipyridamole, and GPIIb/IIIa antagonists.

### ASPIRIN

The most widely used antiplatelet agent worldwide is aspirin. As a cheap and effective antiplatelet drug, aspirin serves as the foundation of most antiplatelet strategies.

#### Mechanism of Action

Aspirin produces its antithrombotic effect by irreversibly acetylating and inhibiting platelet cyclooxygenase (COX)-1 (Fig. 22-3), a critical enzyme in the biosynthesis of thromboxane  $A_2$ . At high doses ( $\sim 1$  g/d), aspirin also inhibits COX-2, an inducible COX isoform found in endothelial cells and inflammatory cells. In endothelial cells, COX-2 initiates the synthesis of prostacyclin, a potent vasodilator and inhibitor of platelet aggregation.

**FIGURE 22-3**

**Site of action of antiplatelet drugs.** Aspirin inhibits thromboxane  $A_2$  ( $TXA_2$ ) synthesis by irreversibly acetylating cyclooxygenase-1 (COX-1). Reduced  $TXA_2$  release attenuates platelet activation and recruitment to the site of vascular injury. Ticlopidine and clopidogrel irreversibly block  $P2Y_{12}$ , a key ADP receptor on the platelet surface. Therefore, these agents also attenuate platelet recruitment. Abciximab, eptifibatide, and tirofiban inhibit the final common pathway of platelet aggregation by blocking fibrinogen binding to activated glycoprotein (GP) IIb/IIIa.

COX-2 inhibitors were developed to block the production of inflammatory prostaglandins without affecting platelet function. The various COX-2 inhibitors differ in their selectivity for COX-2 relative to COX-1. By blocking prostacyclin synthesis without concomitant inhibition of thromboxane  $A_2$  production, highly selective inhibitors of COX-2 increase the risk of cardiovascular events. Thus long-term rofecoxib therapy increases the risk of myocardial infarction (MI) three- to fivefold, a finding that led to the withdrawal of this drug from the market.

### Indications

Aspirin is widely used for secondary prevention of cardiovascular events in patients with coronary artery, cerebrovascular, or peripheral vascular disease. Compared with placebo, aspirin produces a 25% reduction in the risk of cardiovascular death, MI, or stroke. Aspirin is also used for primary prevention in patients whose estimated annual risk of MI is  $>1\%$ , a point where its benefits are likely to outweigh harms. This includes patients  $>40$  years of age with two or more major risk factors for cardiovascular disease or those  $>50$  years with one or more such risk factor. Aspirin is equally effective in men and

women. In men, aspirin mainly reduces the risk of MI; in women, aspirin lowers the risk of stroke.

### Dosages

Aspirin is usually administered at doses of 75–325 mg once daily. Higher dose aspirin is not more effective than lower aspirin doses, and some analyses suggest reduced efficacy with higher doses. Because the side effects of aspirin are dose-related, daily aspirin doses of 75–100 mg are recommended for most indications. When rapid platelet inhibition is required, an initial aspirin dose of at least 160 mg should be given.

### Side Effects

Most common side effects are gastrointestinal and range from dyspepsia to erosive gastritis or peptic ulcers with bleeding and perforation. These side effects are dose-related. Use of enteric-coated or buffered aspirin in place of plain aspirin does not eliminate the risk of gastrointestinal side effects. The overall risk of major bleeding with aspirin is 1–3% per year. The risk of bleeding is increased when aspirin is given in conjunction with anticoagulants, such as warfarin. When dual therapy is used, low-dose aspirin should be given (75–100 mg daily). Eradication of *Helicobacter pylori* infection and administration of proton pump inhibitors may reduce the risk of aspirin-induced gastrointestinal bleeding in patients with peptic ulcer disease.

Aspirin should not be administered to patients with a history of aspirin allergy characterized by bronchospasm. This problem occurs in  $\sim 0.3\%$  of the general population but is more common in those with chronic urticaria or asthma, particularly in individuals with nasal polyps or chronic rhinitis. Hepatic and renal toxicity are observed with aspirin overdose.

### Aspirin Resistance

Clinical aspirin resistance is defined as the failure of aspirin to protect patients from ischemic vascular events. This is not a helpful definition because it is made after the event occurs. Furthermore, it is not realistic to expect aspirin, which only blocks thromboxane  $A_2$ -induced platelet activation, to prevent all vascular events.

Aspirin resistance has also been described biochemically as failure of the drug to produce its expected inhibitory effects on tests of platelet function, such as thromboxane  $A_2$  synthesis or arachidonic acid-induced platelet aggregation. However, the tests of platelet function used for diagnosis of biochemical aspirin resistance have not been well standardized. Furthermore, these tests are not proven to identify patients at risk of recurrent vascular events. In addition, resistance is not reversed by either giving higher doses of aspirin or adding other antiplatelet drugs. Thus testing for aspirin resistance remains a research tool.

## THIENOPYRIDINES

The thienopyridines include ticlopidine and clopidogrel, drugs that target P2Y<sub>12</sub>, a key ADP receptor on platelets.

### Mechanism of Action

The thienopyridines are structurally related drugs that selectively inhibit ADP-induced platelet aggregation by irreversibly blocking P2Y<sub>12</sub> (Fig. 22-3). Ticlopidine and clopidogrel are both prodrugs that must be metabolized by the hepatic cytochrome P450 (CYP) enzyme system to acquire activity. Consequently, when given in usual doses, their onset of action is delayed for several days.

### Indications

Like aspirin, ticlopidine is more effective than placebo at reducing the risk of cardiovascular death, MI, and stroke in patients with atherosclerotic disease. Because of its delayed onset of action, ticlopidine is not recommended in patients with acute MI. Ticlopidine was used routinely as an adjunct to aspirin after coronary artery stenting and as an aspirin substitute in those intolerant to aspirin. Because clopidogrel is more potent than ticlopidine and has a better safety profile, clopidogrel has replaced ticlopidine.

When compared with aspirin in patients with recent ischemic stroke, MI, or peripheral arterial disease, clopidogrel reduced the risk of cardiovascular death, MI, and stroke by 8.7%. Therefore, clopidogrel is more effective than aspirin but is also more expensive. In some patients, clopidogrel and aspirin are combined to capitalize on their capacity to block complementary pathways of platelet activation. For example, the combination of aspirin plus clopidogrel is recommended for at least 4 weeks after implantation of a bare metal stent in a coronary artery and longer in those with a drug-eluting stent. Concerns about late in-stent thrombosis with drug-eluting stents have led some experts to recommend long-term use of clopidogrel plus aspirin for this indication.

The combination of clopidogrel and aspirin is also effective in patients with unstable angina. Thus, in 12,562 such patients, the risk of cardiovascular death, MI, or stroke was 9.3% in those randomized to the combination of clopidogrel and aspirin and 11.4% in those given aspirin alone. This 20% relative risk reduction with combination therapy was highly statistically significant. However, combining clopidogrel with aspirin increases the risk of major bleeding to ~2% per year. This bleeding risk persists even if the daily dose of aspirin is ≤100 mg. Therefore, the combination of clopidogrel and aspirin should only be used when there is a clear benefit. For example, this combination has not proven to be superior to clopidogrel alone in patients with acute ischemic stroke or to aspirin alone for primary prevention in those at risk for cardiovascular events.

### Dosing

Ticlopidine is given twice daily at a dose of 250 mg. The more potent clopidogrel is given once daily at a dose of 75 mg. Loading doses of clopidogrel are given when rapid ADP receptor blockade is desired. For example, patients undergoing coronary stenting are often given a loading dose of 300 mg, which effects inhibition of ADP-induced platelet aggregation in ~6 h. Loading doses of 600 or 900 mg produce an even more rapid effect.

### Side Effects

The most common side effects of ticlopidine are gastrointestinal. More serious are the hematologic side effects, which include neutropenia, thrombocytopenia, and thrombotic thrombocytopenic purpura. These side effects usually occur within the first few months of starting treatment. Therefore, blood counts must be carefully monitored when initiating therapy with ticlopidine. Gastrointestinal and hematologic side effects are rare with clopidogrel.

### Thienopyridine Resistance

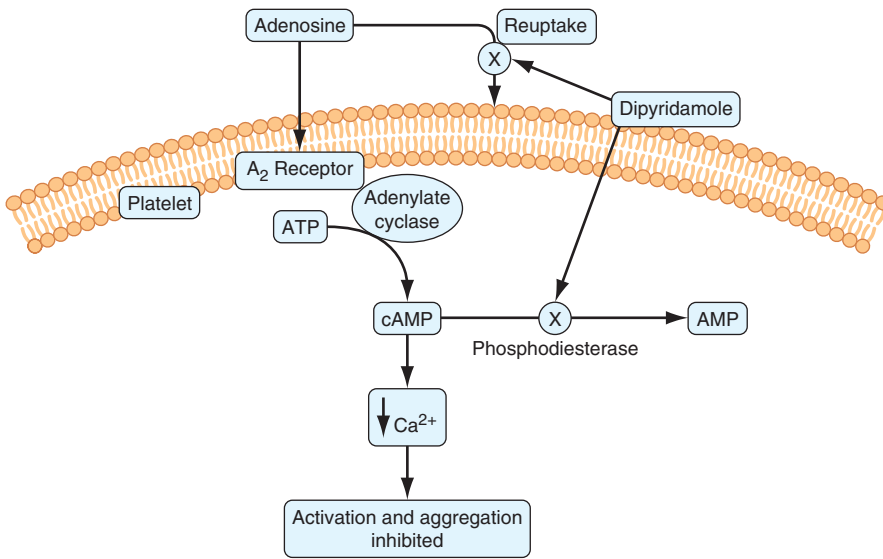
There is between-subject variability in the capacity of the thienopyridines to inhibit ADP-induced platelet aggregation. This variability reflects, at least in part, genetic polymorphisms in the CYP isoenzymes involved in the metabolic activation of the drugs. For example, subjects with the *CYP2C19\*2* allele exhibit decreased responsiveness to clopidogrel, as do those with reduced *CYP3A4* activity. These findings raise the possibility that pharmacogenomic profiling may help identify clopidogrel-resistant patients. Point-of-care devices that assess the extent of platelet inhibition may also help to identify these patients. It is currently unknown, however, whether patients with biochemical evidence of clopidogrel resistance have a poorer outcome and whether administration of higher doses of clopidogrel to these patients overcomes this problem.

## DIPYRIDAMOLE

Dipyridamole is a relatively weak antiplatelet agent on its own, but an extended-release formulation of dipyridamole combined with low-dose aspirin, a preparation known as *Aggrenox*, is used for prevention of stroke in patients with transient ischemic attacks.

### Mechanism of Action

By inhibiting phosphodiesterase, dipyridamole blocks the breakdown of cAMP. Increased levels of cAMP reduce intracellular calcium and inhibit platelet activation. Dipyridamole also blocks the uptake of adenosine by platelets and other cells. This produces a further increase in local cAMP levels because the platelet adenosine A<sub>2</sub> receptor is coupled to adenylate cyclase (Fig. 22-4).

**FIGURE 22-4****Mechanism of action of dipyridamole.**

Dipyridamole increases levels of cyclic AMP in platelets by (1) blocking the reuptake of adenosine, and (2) inhibiting phosphodiesterase-mediated cyclic AMP degradation. By promoting calcium uptake, cyclic AMP reduces intracellular levels of calcium. This, in turn, inhibits platelet activation and aggregation.

**Dosing**

Aggrenox is given twice daily. Each capsule contains 200 mg of extended-release dipyridamole and 25 mg of aspirin.

**Side Effects**

Because dipyridamole has vasodilatory effects, it must be used with caution in patients with coronary artery disease. Gastrointestinal complaints, headache, facial flushing, dizziness, and hypotension can also occur. These symptoms often subside with continued use of the drug.

**Indications**

Dipyridamole plus aspirin was compared with aspirin or dipyridamole alone, or with placebo, in patients with an ischemic stroke or transient ischemic attack. The combination reduced the risk of stroke by 22.1% compared with aspirin and by 24.4% compared with dipyridamole. A second trial compared dipyridamole plus aspirin with aspirin alone for secondary prevention in patients with ischemic stroke. Vascular death, stroke, or MI occurred in 13% of patients given combination therapy and in 16% of those treated with aspirin alone. Based on these data, Aggrenox is often used for stroke prevention. However, because of its vasodilatory effects and the paucity of data supporting the use of dipyridamole in patients with symptomatic coronary artery disease, Aggrenox should not be used for stroke prevention in such patients.

**GPIIb/IIIa RECEPTOR ANTAGONISTS**

As a class, parenteral GPIIb/IIIa receptor antagonists have an established niche in patients with acute coronary syndromes. The three agents in this class are abciximab, eptifibatide, and tirofiban.

**Mechanism of Action**

A member of the integrin family of adhesion receptors, GPIIb/IIIa is found on the surface of platelets and megakaryocytes. With ~80,000 copies per platelet, GPIIb/IIIa is the most abundant receptor. Consisting of a non-covalently linked heterodimer, GPIIb/IIIa is inactive on resting platelets. When platelets are activated, inside-outside signal transduction pathways trigger a conformational activation of the receptor. Once activated, GPIIb/IIIa binds adhesive molecules, such as fibrinogen and, under high shear conditions, vWF. Binding is mediated by the Arg-Gly-Asp (RGD) sequence found on the  $\alpha$  chains of fibrinogen and on vWF, and by the Lys-Gly-Asp (KGD) sequence located within a unique dodecapeptide domain on the  $\gamma$  chains of fibrinogen. Once bound, fibrinogen and/or vWF bridge adjacent platelets together to induce platelet aggregation.

Although abciximab, eptifibatide, and tirofiban all target the GPIIb/IIIa receptor, they are structurally and pharmacologically distinct (Table 22-1). Abciximab is a Fab fragment of a humanized murine monoclonal antibody directed against the activated form of GPIIb/IIIa. Abciximab binds to the activated receptor with high affinity and blocks the binding of adhesive molecules. In contrast to abciximab, eptifibatide and tirofiban are synthetic small molecules. Eptifibatide is a cyclic heptapeptide that binds GPIIb/IIIa because it incorporates the KGD motif, whereas tirofiban is a nonpeptidic tyrosine derivative that acts as a RGD mimetic. Abciximab has a long half-life and can be detected on the surface of platelets for up to 2 weeks. Eptifibatide and tirofiban have shorter half-lives.

In addition to targeting the GPIIb/IIIa receptor, abciximab also inhibits the closely related  $\alpha_v\beta_3$  receptor, which binds vitronectin, and  $\alpha_M\beta_2$ , a leukocyte integrin. In contrast, eptifibatide and tirofiban are specific for

TABLE 22-1

FEATURES OF GPIIb/IIIa ANTAGONISTS			
FEATURE	ABCIXIMAB	EPTIFIBATIDE	TIROFIBAN
Description	Fab fragment of humanized mouse monoclonal antibody	Cyclical KGD-containing heptapeptide	Nonpeptidic RGD mimetic
Specific for GPIIb/IIIa	No	Yes	Yes
Plasma half-life	Short (min)	Long (2.5 h)	Long (2.0 h)
Platelet-bound half-life	Long (days)	Short (s)	Short (s)
Renal clearance	No	Yes	Yes

**Note:** KGD, Lys-Gly-Asp; RGD, Arg-Gly-Asp.

GPIIb/IIIa. Inhibition of  $\alpha_v\beta_3$  and  $\alpha_M\beta_2$  may endow abciximab with anti-inflammatory and/or antiproliferative properties that extend beyond platelet inhibition.

### Dosing

All of the GPIIb/IIIa antagonists are given as an IV bolus followed by an infusion. Because they are cleared by the kidneys, the doses of eptifibatide and tirofiban must be reduced in patients with renal insufficiency.

### Side Effects

In addition to bleeding, thrombocytopenia is the most serious complication. Thrombocytopenia is immune-mediated and caused by antibodies directed against neoantigens on GPIIb/IIIa that are exposed upon antagonist binding. With abciximab, thrombocytopenia occurs in up to 5% of patients. Thrombocytopenia is severe in ~1% of these individuals. Thrombocytopenia is less common with the other two agents, occurring in ~1% of patients.

### Indications

Abciximab and eptifibatide are used in patients undergoing percutaneous coronary interventions, particularly those with acute MI. Tirofiban is used in high-risk patients with unstable angina. Eptifibatide also can be used for this indication.

## NEW ANTIPLATELET AGENTS

Thienopyridines that produce more predictable suppression of ADP-induced platelet aggregation are under investigation. Direct-acting reversible P2Y<sub>12</sub> antagonists have also been developed. These agents can be given orally or parenterally and have a rapid onset of action because they are not prodrugs. Finally, orally active inhibitors of the type 1 protease activated receptor (PAR-1), the major thrombin receptor on platelets, are also entering clinical trials.

## ANTICOAGULANTS

There are both parenteral and oral anticoagulants. Currently available parenteral anticoagulants include heparin,

low-molecular-weight heparin (LMWH), and fondaparinux, a synthetic pentasaccharide. The only available oral anticoagulants are the vitamin K antagonists, of which warfarin is the agent most often used in North America.

## PARENTERAL ANTICOAGULANTS

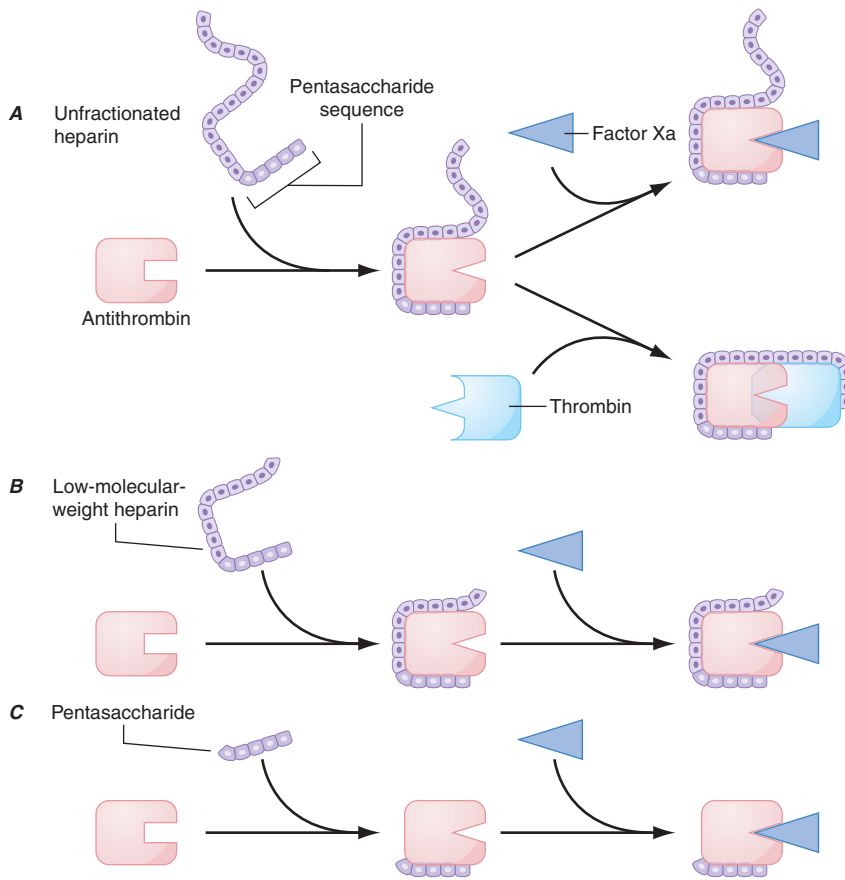
### Heparin

Heparin is a sulfated polysaccharide and isolated from mammalian tissues rich in mast cells. Most commercial heparin is derived from porcine intestinal mucosa and is a polymer of alternating D-glucuronic acid and N-acetyl-D-glucosamine residues.

### Mechanism of Action

Heparin acts as an anticoagulant by activating antithrombin (previously known as antithrombin III) and accelerating the rate at which antithrombin inhibits clotting enzymes, particularly thrombin and factor Xa. Antithrombin, the obligatory plasma cofactor for heparin, is a member of the serine protease inhibitor (serpin) superfamily. Synthesized in the liver and circulating in plasma at a concentration of  $2.6 \pm 0.4 \mu\text{M}$ , antithrombin acts as a suicide substrate for its target enzymes.

To activate antithrombin, heparin binds to the serpin via a unique pentasaccharide sequence that is found on a third of the chains of commercial heparin (Fig. 22-5). The remainder of the heparin chains that lack this pentasaccharide sequence have little or no anticoagulant activity. Once bound to antithrombin, heparin induces a conformational change in the reactive center loop of antithrombin that renders it more readily accessible to its target proteases. This conformational change enhances the rate at which antithrombin inhibits factor Xa by at least two orders of magnitude but has little effect on the rate of thrombin inhibition by antithrombin. To catalyze thrombin inhibition, heparin serves as a template that binds antithrombin and thrombin simultaneously. Formation of this ternary complex brings the enzyme in close apposition to the inhibitor, thereby promoting the formation of a stable covalent thrombin-antithrombin complex.

**FIGURE 22-5**

**Mechanism of action of heparin, low-molecular-weight heparin (LMWH), and fondaparinux, a synthetic pentasaccharide.**

**A.** Heparin binds to antithrombin via its pentasaccharide sequence. This induces a conformational change in the reactive center loop of antithrombin that accelerates its interaction with factor Xa. To potentiate thrombin inhibition, heparin must simultaneously bind to antithrombin and thrombin. Only heparin chains composed of at least 18 saccharide units, which corresponds to a molecular weight of 5400, are of sufficient length to perform this bridging function. With a mean molecular weight of 15,000, all of the heparin chains are long enough to do this. **B.** LMWH has greater capacity to potentiate factor Xa inhibition by antithrombin than thrombin because, with a mean molecular weight of 4500–5000, at least half of the LMWH chains are too short to bridge antithrombin to thrombin. **C.** The pentasaccharide only accelerates factor Xa inhibition by antithrombin because the pentasaccharide is too short to bridge antithrombin to thrombin.

Only pentasaccharide-containing heparin chains composed of at least 18 saccharide units (which correspond to a molecular weight of 5400) are of sufficient length to bridge thrombin and antithrombin together. With a mean molecular weight of 15,000, and a range of 5000–30,000, almost all of the chains of unfractionated heparin are long enough to effect this bridging function. Consequently, by definition, heparin has equal capacity to promote the inhibition of thrombin and factor Xa by antithrombin and is assigned an anti-factor Xa to anti-factor IIa (thrombin) ratio of 1:1.

Heparin causes the release of tissue factor pathway inhibitor (TFPI) from the endothelium. A factor Xa-dependent inhibitor of tissue factor-bound factor VIIa, TFPI may contribute to the antithrombotic activity of heparin. Longer heparin chains induce the release of more TFPI than shorter chains.

### Pharmacology

Heparin must be given parenterally. It is usually administered SC or by continuous IV infusion. When used for therapeutic purposes, the IV route is most often employed. If heparin is given SC for treatment of thrombosis, the dose of heparin must be high enough to overcome the limited bioavailability associated with this method of delivery.

In the circulation, heparin binds to the endothelium and to plasma proteins other than antithrombin. Heparin

binding to endothelial cells explains its dose-dependent clearance. At low doses, the half-life of heparin is short because it binds rapidly to the endothelium. With higher doses of heparin, the half-life is longer because heparin is cleared more slowly once the endothelium is saturated. Clearance is mainly extrarenal; heparin binds to macrophages, which internalize and depolymerize the long heparin chains and secrete shorter chains back into the circulation. Because of its dose-dependent clearance mechanism, the plasma half-life of heparin ranges from 30–60 min with bolus IV doses of 25 and 100 U/kg, respectively.

Once heparin enters the circulation, it binds to plasma proteins other than antithrombin, a phenomenon that reduces its anticoagulant activity. Some of the heparin-binding proteins found in plasma are acute-phase reactants whose levels are elevated in ill patients. Others, such as high-molecular-weight multimers of vWF, are released from activated platelets or endothelial cells. Activated platelets also release platelet factor 4 (PF4), a highly cationic protein that binds heparin with high affinity. The large amounts of PF4 found in the vicinity of platelet-rich arterial thrombi can neutralize the anticoagulant activity of heparin. This phenomenon may attenuate heparin's capacity to suppress thrombus growth.

Because the levels of heparin-binding proteins in plasma vary from person to person, the anticoagulant response to fixed or weight-adjusted doses of heparin is

unpredictable. Consequently, coagulation monitoring is essential to ensure that a therapeutic response is obtained. This is particularly important when heparin is administered for treatment of established thrombosis because a subtherapeutic anticoagulant response may render patients at risk for recurrent thrombosis, whereas excessive anticoagulation increases the risk of bleeding.

### Monitoring the Anticoagulant Effect

Heparin therapy can be monitored using the activated partial thromboplastin time (aPTT) or anti-factor Xa level. Although the aPTT is the test most often employed for this purpose, there are problems with this assay. aPTT reagents vary in their sensitivity to heparin, and the type of coagulometer used for testing can influence the results. Consequently, laboratories must establish a therapeutic aPTT range with each reagent-coagulometer combination by measuring the aPTT and anti-factor Xa level in plasma samples collected from heparin-treated patients. For most of the aPTT reagents and coagulometers in current use, therapeutic heparin levels are achieved with a two- to threefold prolongation of the aPTT.

Anti-factor Xa levels also can be used to monitor heparin therapy. With this test, therapeutic heparin levels range from 0.3–0.7 units/mL. Although this test is gaining in popularity, anti-factor Xa assays have yet to be standardized, and results can vary widely between laboratories.

Up to 25% of heparin-treated patients with venous thromboembolism require >35,000 units/d to achieve a therapeutic aPTT. These patients are considered heparin resistant. It is useful to measure anti-factor Xa levels in heparin-resistant patients because many will have a therapeutic anti-factor Xa level despite a subtherapeutic aPTT. This dissociation in test results occurs because elevated plasma levels of fibrinogen and factor VIII, both of which are acute-phase proteins, shorten the aPTT but have no effect on anti-factor Xa levels. Heparin therapy in patients who exhibit this phenomenon is best monitored using anti-factor Xa levels instead of the aPTT. Patients with congenital or acquired antithrombin deficiency and those with elevated levels of heparin-binding proteins may also need high doses of heparin to achieve a therapeutic aPTT or anti-factor Xa level. If there is good correlation between the aPTT and the anti-factor Xa levels, either test can be used to monitor heparin therapy.

### Dosing

For prophylaxis, heparin is usually given in fixed doses of 5000 units SC two or three times daily. With these low doses, coagulation monitoring is unnecessary. In contrast, monitoring is essential when the drug is given in therapeutic doses. Fixed-dose or weight-based heparin nomograms are used to standardize heparin dosing and to shorten the time required to achieve a therapeutic

anticoagulant response. At least two heparin nomograms have been validated in patients with venous thromboembolism and reduce the time required to achieve a therapeutic aPTT. Weight-adjusted heparin nomograms have also been evaluated in patients with acute coronary syndromes. After an IV heparin bolus of 5000 units or 70 units/kg, a heparin infusion rate of 12–15 units/kg per hour is usually administered. In contrast, weight-adjusted heparin nomograms for patients with venous thromboembolism use an initial bolus of 5000 units or 80 units/kg, followed by an infusion of 18 units/kg per hour. Thus patients with venous thromboembolism appear to require higher doses of heparin to achieve a therapeutic aPTT than do patients with acute coronary syndromes. This may reflect differences in the thrombus burden. Heparin binds to fibrin, and the fibrin content of extensive deep vein thrombi is greater than that of small coronary thrombi.

### Limitations

Heparin has pharmacokinetic and biophysical limitations (Table 22-2). The pharmacokinetic limitations reflect heparin's propensity to bind in a pentasaccharide-independent fashion to cells and plasma proteins. Heparin binding to endothelial cells explains its dose-dependent clearance, whereas binding to plasma proteins results in a variable anticoagulant response and can lead to heparin resistance.

The biophysical limitations of heparin reflect the inability of the heparin-antithrombin complex to (1) inhibit factor Xa when it is incorporated into the prothrombinase complex, the complex that converts prothrombin to thrombin; and (2) to inhibit thrombin bound to fibrin. Consequently, factor Xa bound to activated platelets within platelet-rich thrombi has the potential

TABLE 22-2

#### PHARMACOKINETIC AND BIOPHYSICAL LIMITATIONS OF HEPARIN

LIMITATIONS	MECHANISM
Poor bioavailability at low doses	Binds to proteins in subcutaneous depot site
Dose-dependent clearance	Binds to macrophages
Variable anticoagulant response	Binds to plasma proteins whose levels vary from patient to patient
Reduced activity in the vicinity of platelet-rich thrombi	Neutralized by platelet factor 4 released from activated platelets
Limited activity against factor Xa incorporated in the prothrombinase complex and thrombin bound to fibrin	Reduced capacity of heparin-antithrombin complex to inhibit factor Xa bound to activated platelets and thrombin bound to fibrin



272 to generate thrombin, even in the face of heparin. Once this thrombin binds to fibrin, it too is protected from inhibition by the heparin-antithrombin complex. Clot-associated thrombin can then trigger thrombus growth by locally activating platelets and amplifying its own generation through feedback activation of factors V, VIII, and XI. Further compounding the problem is the potential for heparin neutralization by the high concentrations of PF4 released from activated platelets within the platelet-rich thrombus.

### Side Effects

The most common side effect of heparin is bleeding. Other complications include thrombocytopenia, osteoporosis, and elevated levels of transaminases.

### Bleeding

The risk of heparin-induced bleeding increases with higher heparin doses. Concomitant administration of drugs that affect hemostasis, such as antiplatelet or fibrinolytic agents, increases the risk of bleeding, as does recent surgery or trauma. Heparin-treated patients with serious bleeding can be given protamine sulfate to neutralize the heparin. Protamine sulfate, a mixture of basic polypeptides isolated from salmon sperm, binds heparin with high affinity, and the resultant protamine-heparin complexes are then cleared. Typically, 1 mg of protamine sulfate neutralizes 100 units of heparin. Protamine sulfate is given IV. Anaphylactoid reactions to protamine sulfate can occur, and drug administration by slow IV infusion is recommended to reduce the risk.

### Thrombocytopenia

Heparin can cause thrombocytopenia. Heparin-induced thrombocytopenia (HIT) is an antibody-mediated process triggered by antibodies directed against neoantigens on PF4 that are exposed when heparin binds to this protein. These antibodies, which are usually of the IgG isotype, bind simultaneously to the heparin-PF4 complex and to platelet Fc receptors. Such binding activates the platelets and generates platelet microparticles. Circulating microparticles are prothrombotic because they express anionic phospholipids on their surface and can bind clotting factors and promote thrombin generation.

The clinical features of HIT are illustrated in [Table 22-3](#). Typically, HIT occurs 5–14 days after initiation of heparin therapy, but it can manifest earlier if the patient has received heparin within the past 3 months. It is rare for the platelet count to fall below 100,000/ $\mu\text{L}$  in patients with HIT, and even a 50% decrease in the platelet count from the pretreatment value should raise the suspicion of HIT in those receiving heparin. HIT is more common in surgical patients than in medical patients and, like many autoimmune disorders, occurs more frequently in females than in males.

**TABLE 22-3**

### FEATURES OF HEPARIN-INDUCED THROMBOCYTOPENIA

FEATURES	DETAILS
Thrombocytopenia	Platelet count of $\leq 100,000/\mu\text{L}$ or a decrease in platelet count of $\geq 50\%$
Timing	Platelet count falls 5–10 days after starting heparin
Type of heparin	More common with unfractionated heparin than with low-molecular-weight heparin
Type of patient	More common in surgical patients than medical patients; more common in women than in men.
Thrombosis	Venous thrombosis more common than arterial thrombosis

HIT can be associated with thrombosis, either arterial or venous. Venous thrombosis, which manifests as DVT and/or PE, is more common than arterial thrombosis. Arterial thrombosis can manifest as ischemic stroke or acute MI. Rarely, platelet-rich thrombi in the distal aorta or iliac arteries can cause critical limb ischemia.

The diagnosis of HIT is established using enzyme-linked assays to detect antibodies against heparin-PF4 complexes or with platelet activation assays. Enzyme-linked assays are sensitive but can be positive in the absence of any clinical evidence of HIT. The most specific diagnostic test is the serotonin release assay. This test is performed by quantifying serotonin release when washed platelets loaded with labeled serotonin are exposed to patient serum in the absence or presence of varying concentrations of heparin. If the patient serum contains the HIT antibody, heparin addition induces platelet activation and serotonin release.

Management of HIT is outlined in [Table 22-4](#). Heparin should be stopped in patients with suspected or documented HIT, and an alternative anticoagulant should be administered to prevent or treat thrombosis. The agents most often used for this indication are parenteral direct thrombin inhibitors, such as lepirudin,

**TABLE 22-4**

### MANAGEMENT OF HEPARIN-INDUCED THROMBOCYTOPENIA

Stop all heparin
Give an alternative anticoagulant, such as lepirudin, argatroban, bivalirudin, danaparoid, or fondaparinux
Do not give platelet transfusions
Do not give warfarin until the platelet count returns to its baseline level; if warfarin is administered, give vitamin K to restore the INR to normal
Evaluate for thrombosis, particularly deep vein thrombosis

argatroban, or bivalirudin, or factor Xa inhibitors, such as fondaparinux or danaparoid.

Patients with HIT, particularly those with associated thrombosis, often have evidence of increased thrombin generation that can lead to consumption of protein C. If these patients are given warfarin without a concomitant parenteral anticoagulant to inhibit thrombin or thrombin generation, the further decrease in protein C levels induced by the vitamin K antagonist can trigger skin necrosis. To avoid this problem, patients with HIT should be treated with a direct thrombin inhibitor or fondaparinux until the platelet count returns to normal levels. At this point, low-dose warfarin therapy can be introduced, and the thrombin inhibitor can be discontinued when the anticoagulant response to warfarin has been therapeutic for at least 2 days.

### Osteoporosis

Treatment with therapeutic doses of heparin for >1 month can cause a reduction in bone density. This complication has been reported in up to 30% of patients given long-term heparin therapy, and symptomatic vertebral fractures occur in 2–3% of these individuals.

Heparin causes bone loss both by decreasing bone formation and by enhancing bone resorption. Thus heparin affects the activity of both osteoblasts and osteoclasts.

### Elevated Levels of Transaminases

Therapeutic doses of heparin frequently cause modest elevation in the serum levels of hepatic transaminases, without a concomitant increase in the level of bilirubin. The levels of transaminases rapidly return to normal when the drug is stopped. The mechanism of this phenomenon is unknown.

### Low-Molecular-Weight Heparin

Consisting of smaller fragments of heparin, LMWH is prepared from unfractionated heparin by controlled enzymatic or chemical depolymerization. The mean molecular weight of LMWH is 5000, a third the mean molecular weight of unfractionated heparin. LMWH has advantages over heparin (Table 22-5) and has replaced heparin for most indications.

### Mechanism of Action

Like heparin, LMWH exerts its anticoagulant activity by activating antithrombin. With a mean molecular weight of 5000, which corresponds to about 17 saccharide units, at least half of the pentasaccharide-containing chains of LMWH are too short to bridge thrombin to antithrombin (Fig. 22-5). However, these chains retain the capacity to accelerate factor Xa inhibition by antithrombin because this activity is largely the result of the conformational changes in antithrombin evoked by pentasaccharide binding. Consequently, LMWH

**TABLE 22-5**

### ADVANTAGES OF LMWH OVER HEPARIN

ADVANTAGE	CONSEQUENCE
Better bioavailability and longer half-life after SC injection	Can be given SC once or twice daily for both prophylaxis and treatment
Dose-independent clearance	Simplified dosing
Predictable anticoagulant response	Coagulation monitoring is unnecessary in most patients
Lower risk of heparin-induced thrombocytopenia	Safer than heparin for short- or long-term administration
Lower risk of osteoporosis	Safer than heparin for extended administration

**Note:** LMWH, low-molecular-weight heparin.

catalyzes factor Xa inhibition by antithrombin more than thrombin inhibition. Depending on their unique molecular weight distributions, LMWH preparations have anti-factor Xa to anti-factor IIa ratios ranging from 2:1–4:1.

### Pharmacology

Although usually given SC, LMWH also can be administered IV if a rapid anticoagulant response is needed. LMWH has pharmacokinetic advantages over heparin. These advantages reflect the fact that shorter heparin chains bind less avidly to endothelial cells, macrophages, and heparin-binding plasma proteins. Reduced binding to endothelial cells and macrophages eliminates the rapid, dose-dependent, and saturable mechanism of clearance that is a characteristic of unfractionated heparin. Instead, the clearance of LMWH is dose-independent and its plasma half-life is longer. Based on measurement of anti-factor Xa levels, LMWH has a plasma half-life of ~4 h. LMWH is cleared almost exclusively by the kidneys, and the drug can accumulate in patients with renal insufficiency.

LMWH exhibits ~90% bioavailability after SC injection. Because LMWH binds less avidly to heparin-binding proteins in plasma than heparin, LMWH produces a more predictable dose response, and resistance to LMWH is rare. With a longer half-life and more predictable anticoagulant response, LMWH can be given SC once or twice daily without coagulation monitoring, even when the drug is given in treatment doses. These properties render LMWH more convenient than unfractionated heparin. Capitalizing on this feature, studies in patients with venous thromboembolism have shown that home treatment with LMWH is as effective and safe as in-hospital treatment with continuous IV infusions of heparin. Outpatient treatment with LMWH streamlines care, reduces health care costs, and increases patient satisfaction.

In most patients, LMWH does not require coagulation monitoring. If monitoring is necessary, anti-factor Xa levels must be measured because most LMWH preparations have little effect on the aPTT. Therapeutic anti-factor Xa levels with LMWH range from 0.5–1.2 units/mL when measured 3–4 h after drug administration. When LMWH is given in prophylactic doses, peak anti-factor Xa levels of 0.2–0.5 units/mL are desirable.

Indications for LMWH monitoring include renal insufficiency and obesity. LMWH monitoring in patients with a creatinine clearance of  $\leq 50$  mL/min is advisable to ensure there is no drug accumulation. Although weight-adjusted LMWH dosing appears to produce therapeutic anti-factor Xa levels in patients who are overweight, this approach has not been extensively evaluated in those with morbid obesity. It may also be advisable to monitor the anticoagulant activity of LMWH during pregnancy because dose requirements can change, particularly in the third trimester. Monitoring should also be considered in high-risk settings, such as in patients with mechanical heart valves who are given LMWH for prevention of valve thrombosis, and when LMWH is used in treatment doses in infants or children.

### Dosing

The doses of LMWH recommended for prophylaxis or treatment vary depending on the LMWH preparation. For prophylaxis, once-daily SC doses of 4000–5000 units are often used, whereas doses of 2500–3000 units are given when the drug is administered twice daily. For treatment of venous thromboembolism, a dose of 150–200 units/kg is given if the drug is administered once daily. If a twice-daily regimen is employed, a dose of 100 units/kg is given. In patients with unstable angina, LMWH is given SC on a twice-daily basis at a dose of 100–120 units/kg.

### Side Effects

The major complication of LMWH is bleeding. Meta-analyses suggest that the risk of major bleeding is lower with LMWH than with unfractionated heparin. HIT and osteoporosis are less common with LMWH than with unfractionated heparin.

### Bleeding

Like the situation with heparin, bleeding with LMWH is more common in patients receiving concomitant therapy with antiplatelet or fibrinolytic drugs. Recent surgery, trauma, or underlying hemostatic defects also increase the risk of bleeding with LMWH.

Although protamine sulfate can be used as an antidote for LMWH, protamine sulfate incompletely neutralizes the anticoagulant activity of LMWH because it only binds the longer chains of LMWH. Because longer

chains are responsible for catalysis of thrombin inhibition by antithrombin, protamine sulfate completely reverses the anti-factor IIa activity of LMWH. In contrast, protamine sulfate only partially reverses the anti-factor Xa activity of LMWH because the shorter pentasaccharide-containing chains of LMWH do not bind to protamine sulfate. Consequently, patients at high risk for bleeding may be more safely treated with continuous IV unfractionated heparin than with SC LMWH.

### Thrombocytopenia

The risk of HIT is about fivefold lower with LMWH than with heparin. LMWH binds less avidly to platelets and causes less PF4 release. Furthermore, with lower affinity for PF4 than heparin, LMWH is less likely to induce the conformational changes in PF4 that trigger the formation of HIT antibodies.

LMWH should not be used to treat HIT patients because most HIT antibodies exhibit cross-reactivity with LMWH. This *in vitro* cross-reactivity is not simply a laboratory phenomenon because there are case reports of thrombosis when HIT patients are treated with LMWH.

### Osteoporosis

The risk of osteoporosis is lower with long-term LMWH than with heparin. For extended treatment, therefore, LMWH is a better choice than heparin because of the lower risk of osteoporosis and HIT.

### Fondaparinux

A synthetic analogue of the antithrombin-binding pentasaccharide sequence, fondaparinux differs from LMWH in several ways (Table 22-6). Fondaparinux is licensed for thromboprophylaxis in general surgical and high-risk orthopedic patients and as an alternative to

TABLE 22-6

#### COMPARISON OF LMWH AND FONDAPARINUX

FEATURES	LMWH	FONDAPARINUX
Number of saccharide units	15–17	5
Catalysis of factor Xa inhibition	Yes	Yes
Catalysis of thrombin inhibition	Yes	No
Bioavailability after subcutaneous administration (%)	90	100
Plasma half-life (h)	4	17
Renal excretion	Yes	Yes
Induces release of tissue factor pathway inhibitor	Yes	No
Neutralized by protamine sulfate	Partially	No

**Note:** LMWH, low-molecular-weight heparin.

heparin or LMWH for initial treatment of patients with established venous thromboembolism. It is likely that fondaparinux will also be approved for treatment of patients with acute coronary syndromes.

### Mechanism of Action

As a synthetic analogue of the antithrombin-binding pentasaccharide sequence found in heparin and LMWH, fondaparinux has a molecular weight of 1728. Fondaparinux binds only to antithrombin (Fig. 22-5) and is too short to bridge thrombin to antithrombin. Consequently, fondaparinux catalyzes factor Xa inhibition by antithrombin and does not enhance the rate of thrombin inhibition.

### Pharmacology

Fondaparinux exhibits complete bioavailability after SC injection. With no binding to endothelial cells or plasma proteins, the clearance of fondaparinux is dose independent and its plasma half-life is 17 h. The drug is given SC once daily. Because fondaparinux is cleared unchanged via the kidneys, it is contraindicated in patients with a creatinine clearance <30 mL/min and should be used with caution in those with a creatinine clearance <50 mL/min.

Fondaparinux produces a predictable anticoagulant response after administration in fixed doses because it does not bind to plasma proteins. The drug is given at a dose of 2.5 mg once daily for prevention of venous thromboembolism. For initial treatment of established venous thromboembolism, fondaparinux is given at a dose of 7.5 mg once daily. The dose can be reduced to 5 mg once daily for those weighing <50 kg and increased to 10 mg for those >100 kg. When given in these doses, fondaparinux is as effective as heparin or LMWH for initial treatment of patients with DVT or PE and produces similar rates of bleeding.

Fondaparinux is used at a dose of 2.5 mg once daily in patients with acute coronary syndromes. When this prophylactic dose of fondaparinux was compared with treatment doses of enoxaparin in patients with non-ST-segment elevation acute coronary syndromes, there was no difference in the rate of cardiovascular death, MI, or

stroke at 9 days. However, the rate of major bleeding was 50% lower with fondaparinux than with enoxaparin, a difference that likely reflects the fact that the dose of fondaparinux was lower than that of enoxaparin. In acute coronary syndrome patients who require percutaneous coronary interventions, there is a risk of catheter thrombosis with fondaparinux, unless adjunctive heparin is given.

### Side Effects

Fondaparinux does not cause HIT because it does not bind to PF4. In contrast to LMWH, there is no cross-reactivity of fondaparinux with HIT antibodies. Consequently, fondaparinux appears to be effective for treatment of HIT patients, although large clinical trials supporting its use are lacking.

The major side effect of fondaparinux is bleeding. There is no antidote for fondaparinux. Protamine sulfate has no effect on the anticoagulant activity of fondaparinux because it fails to bind to the drug. Recombinant activated factor VII reverses the anticoagulant effects of fondaparinux in volunteers, but it is unknown whether this agent will control fondaparinux-induced bleeding.

### Parenteral Direct Thrombin Inhibitors

Heparin and LMWH are indirect inhibitors of thrombin because their activity is mediated by antithrombin. In contrast, direct thrombin inhibitors do not require a plasma cofactor; instead, these agents bind directly to thrombin and block its interaction with its substrates. Approved parenteral direct thrombin inhibitors include lepirudin, argatroban, and bivalirudin (Table 22-7). Lepirudin and argatroban are licensed for treatment of patients with HIT, whereas bivalirudin is approved as an alternative to heparin in patients undergoing percutaneous coronary interventions, including those with HIT.

### Lepirudin

A recombinant form of hirudin, lepirudin is a bivalent direct thrombin inhibitor that interacts with both the active site and exosite 1, the substrate binding site, on thrombin. For rapid anticoagulation, lepirudin is given

TABLE 22-7

COMPARISON OF THE PROPERTIES OF HIRUDIN, BIVALIRUDIN, AND ARGATROBAN

	HIRUDIN	BIVALIRUDIN	ARGATROBAN
Molecular mass	7000	1980	527
Site(s) of interaction with thrombin	Active site and exosite 1	Active site and exosite 1	Active site
Renal clearance	Yes	No	No
Hepatic metabolism	No	No	Yes
Plasma half-life (min)	60	25	45

276 by continuous IV infusion, but the drug can be given SC for thromboprophylaxis. Lepirudin has a plasma half-life of 60 min after IV infusion and is cleared by the kidneys. Consequently, lepirudin accumulates in patients with renal insufficiency. A high proportion of lepirudin-treated patients develop antibodies against the drug. Although these antibodies rarely cause problems, in a small subset of patients they can delay lepirudin clearance and enhance its anticoagulant activity. Serious bleeding has been reported in some of these patients.

Lepirudin is usually monitored using the aPTT, and the dose is adjusted to maintain an aPTT that is 1.5–2.5 times the control. The aPTT is not an ideal test for monitoring lepirudin therapy because the clotting time plateaus with higher drug concentrations. Although the ecarin clotting time provides a better index of lepirudin dose than the aPTT, the ecarin clotting time has yet to be standardized.

### Argatroban

A univalent inhibitor that targets the active site of thrombin, argatroban is metabolized in the liver. Consequently, this drug must be used with caution in patients with hepatic insufficiency. Argatroban is not cleared via the kidneys, so this drug is safer than lepirudin for HIT patients with renal insufficiency.

Argatroban is administered by continuous IV infusion and has a plasma half-life of ~45 min. The aPTT is used to monitor its anticoagulant effect, and the dose is adjusted to achieve an aPTT 1.5–3 times the baseline value, but not to exceed 100 s. Argatroban also prolongs the international normalized ratio (INR), a feature that can complicate the transitioning of patients to warfarin. This problem can be circumvented by using the levels of factor X to monitor warfarin in place of the INR. Alternatively, argatroban can be stopped for 2–3 h prior to INR determination.

### Bivalirudin

A synthetic 20-amino-acid analogue of hirudin, bivalirudin is a divalent thrombin inhibitor. Thus the N-terminal portion of bivalirudin interacts with the active site of thrombin, whereas its C-terminal tail binds to exosite 1, the substrate-binding domain on thrombin. Bivalirudin has a plasma half-life of 25 min, the shortest half-life of all the parenteral direct thrombin inhibitors. Bivalirudin is degraded by peptidases and is partially excreted via the kidneys. When given in high doses in the cardiac catheterization laboratory, the anticoagulant activity of bivalirudin is monitored using the activated clotting time. With lower doses, its activity can be assessed using the aPTT.

Studies comparing bivalirudin with heparin suggest that bivalirudin produces less bleeding. This feature plus its short half-life make bivalirudin an attractive alternative to heparin in patients undergoing percutaneous

coronary interventions. Bivalirudin also has been used successfully in HIT patients who require percutaneous coronary interventions.

## ORAL ANTICOAGULANTS

Current oral anticoagulant practice dates back almost 60 years to when the vitamin K antagonists were discovered as a result of investigations into the cause of hemorrhagic disease in cattle. Characterized by a decrease in prothrombin levels, this disorder is caused by ingestion of hay containing spoiled sweet clover. Hydroxycoumarin, which was isolated from bacterial contaminants in the hay, interferes with vitamin K metabolism, thereby causing a syndrome similar to vitamin K deficiency.

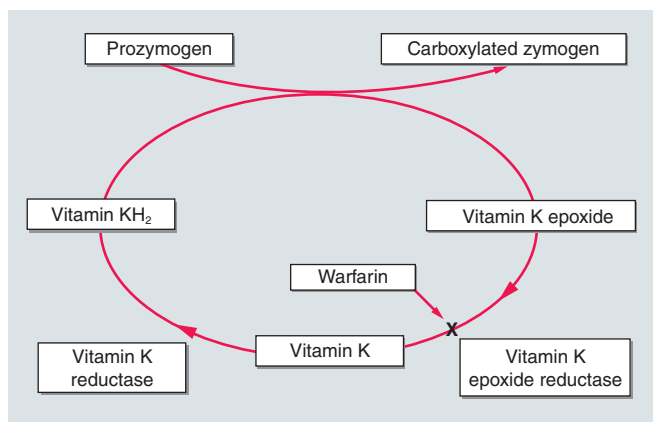
### Warfarin

A water-soluble vitamin K antagonist initially developed as a rodenticide, warfarin is the coumarin derivative most often prescribed in North America. Like other vitamin K antagonists, warfarin interferes with the synthesis of the vitamin K–dependent clotting proteins, which include prothrombin (factor II) and factors VII, IX, and X. The synthesis of the vitamin K–dependent anticoagulant proteins, proteins C and S, is also reduced by vitamin K antagonists.

### Mechanism of Action

All of the vitamin K–dependent clotting factors possess glutamic acid residues at their N termini. A posttranslational modification adds a carboxyl group to the  $\gamma$ -carbon of these residues to generate  $\gamma$ -carboxyglutamic acid. This modification is essential for expression of the activity of these clotting factors because it permits their calcium-dependent binding to negatively charged phospholipid surfaces. The  $\gamma$ -carboxylation process is catalyzed by a vitamin K–dependent carboxylase. Thus vitamin K from the diet is reduced to vitamin K hydroquinone by vitamin K reductase (Fig. 22-6). Vitamin K hydroquinone serves as a cofactor for the carboxylase enzyme, which in the presence of carbon dioxide replaces the hydrogen on the  $\gamma$ -carbon of glutamic acid residues with a carboxyl group. During this process, vitamin K hydroquinone is oxidized to vitamin K epoxide, which is then reduced to vitamin K by vitamin K epoxide reductase.

Warfarin inhibits vitamin K epoxide reductase (VKOR), thereby blocking the  $\gamma$ -carboxylation process. This results in the synthesis of vitamin K–dependent clotting proteins that are only partially  $\gamma$ -carboxylated. Warfarin acts as an anticoagulant because these partially  $\gamma$ -carboxylated proteins have reduced or absent biologic activity. The onset of action of warfarin is delayed until the newly synthesized clotting factors with reduced activity gradually replace their fully active counterparts.



**FIGURE 22-6**

**Mechanism of action of warfarin.** By blocking vitamin K epoxide reductase, warfarin inhibits vitamin K–dependent  $\gamma$ -carboxylation of factors II, VII, IX, and X. Dietary vitamin K is reduced to vitamin K hydroquinone (vitamin  $\text{KH}_2$ ) by vitamin K reductase. Vitamin  $\text{KH}_2$  serves as a cofactor for a vitamin K–dependent carboxylase that catalyzes the  $\gamma$ -carboxylation process, thereby converting prozymogens to zymogens capable of binding calcium and interacting with anionic phospholipid surfaces. During this process, vitamin  $\text{KH}_2$  is oxidized to vitamin K epoxide, which is then reduced to vitamin K by vitamin K epoxide reductase.

The antithrombotic effect of warfarin depends on a reduction in the functional levels of factor X and prothrombin, clotting factors that have half-lives of 24 and 72 h, respectively. Because of the delay in achieving an antithrombotic effect, initial treatment with warfarin is supported by concomitant administration of a rapidly acting parenteral anticoagulant, such as heparin, LMWH, or fondaparinux, in patients with established thrombosis or at high risk for thrombosis.

### Pharmacology

Warfarin is a racemic mixture of R and S isomers. Warfarin is rapidly and almost completely absorbed from the gastrointestinal tract. Levels of warfarin in the blood peak  $\sim 90$  min after drug administration. Racemic warfarin has a plasma half-life of 36–42 h, and  $>97\%$  of circulating warfarin is bound to albumin. It is only the small fraction of unbound warfarin that is biologically active.

Warfarin accumulates in the liver where the two isomers are metabolized via distinct pathways. Oxidative metabolism of the more active S-isomer is effected by CYP2C9. Two relatively common variants, CYP2C9\*2 and CYP2C9\*3, have reduced activity. Patients with these variants require lower maintenance dose of warfarin. Polymorphisms in VKORC1 can also influence the anticoagulant response to warfarin. These findings have prompted the recommendation that patients starting on warfarin should be tested for these polymorphisms and that this information should be incorporated into their warfarin dosing algorithms.

In addition to genetic factors, the anticoagulant effect of warfarin is influenced by diet, drugs, and various disease states. Fluctuations in dietary vitamin K intake affect the activity of warfarin. A wide variety of drugs can alter absorption, clearance, or metabolism of warfarin. Because of the variability in the anticoagulant response to warfarin, coagulation monitoring is essential to ensure that a therapeutic response is obtained.

### Monitoring

Warfarin therapy is most often monitored using the prothrombin time, a test that is sensitive to reductions in the levels of prothrombin, factor VII, and factor X. The test is performed by adding thromboplastin, a reagent that contains tissue factor, phospholipid, and calcium, to citrated plasma and determining the time to clot formation. Thromboplastins vary in their sensitivity to reductions in the levels of the vitamin K–dependent clotting factors. Thus less sensitive thromboplastins will trigger the administration of higher doses of warfarin to achieve a target prothrombin time. This is problematic because higher doses of warfarin increase the risk of bleeding.

The INR was developed to circumvent many of the problems associated with the prothrombin time. To calculate the INR, the patient's prothrombin time is divided by the mean normal prothrombin time, and this ratio is then multiplied by the international sensitivity index (ISI), an index of the sensitivity of the thromboplastin used for prothrombin time determination to reductions in the levels of the vitamin K–dependent clotting factors. Highly sensitive thromboplastins have an ISI of 1.0. Most current thromboplastins have ISI values that range from 1.0–1.4.

Although the INR has helped to standardize anticoagulant practice, problems persist. The precision of INR determination varies depending on reagent-coagulometer combinations. This leads to variability in the INR results. Also complicating INR determination is unreliable reporting of the ISI by thromboplastin manufacturers. Furthermore, every laboratory must establish the mean normal prothrombin time with each new batch of thromboplastin reagent. To accomplish this, the prothrombin time must be measured in fresh plasma samples from at least 20 healthy volunteers using the same coagulometer that is used for patient samples.

For most indications, warfarin is administered in doses that produce a target INR of 2.0–3.0. An exception is patients with mechanical heart valves, where a target INR of 2.5–3.5 is recommended. Studies in atrial fibrillation demonstrate an increased risk of cardioembolic stroke when the INR falls to  $<1.7$  and an increase in bleeding with INR values  $>4.5$ . These findings highlight the fact that vitamin K antagonists have a narrow therapeutic window. In support of this concept, a study in patients receiving long-term warfarin therapy

278 for unprovoked venous thromboembolism demonstrated a higher rate of recurrent venous thromboembolism with a target INR of 1.5–1.9 compared with a target INR of 2.0–3.0.

### Dosing

Warfarin is usually started at a dose of 5–10 mg. The dose is then titrated to achieve the desired target INR. Because of its delayed onset of action, patients with established thrombosis or those at high risk for thrombosis are given concomitant treatment with a rapidly acting parenteral anticoagulant, such as heparin, LMWH, or fondaparinux. Initial prolongation of the INR reflects reduction in the functional levels of factor VII. Consequently, concomitant treatment with the parenteral anticoagulant should be continued until the INR has been therapeutic for at least 2 consecutive days. A minimum 5-day course of parenteral anticoagulation is recommended to ensure that the levels of prothrombin have been reduced into the therapeutic range with warfarin.

Because warfarin has a narrow therapeutic window, frequent coagulation monitoring is essential to ensure that a therapeutic anticoagulant response is obtained. Even patients with stable warfarin dose requirements should have their INR determined every 2–3 weeks. More frequent monitoring is necessary when new medications are introduced because so many drugs enhance or reduce the anticoagulant effects of warfarin.

### Side Effects

Like all anticoagulants, the major side effect of warfarin is bleeding. A rare complication is skin necrosis. Warfarin crosses the placenta and can cause fetal abnormalities. Consequently, warfarin should not be used during pregnancy.

### Bleeding

At least half of the bleeding complications with warfarin occur when the INR exceeds the therapeutic range. Bleeding complications may be mild, such as epistaxis or hematuria, or more severe, such as retroperitoneal or gastrointestinal bleeding. Life-threatening intracranial bleeding can also occur.

To minimize the risk of bleeding, the INR should be maintained in the therapeutic range. In asymptomatic patients whose INR is between 3.5 and 4.5, warfarin should be withheld until the INR returns to the therapeutic range. If the INR is >4.5, a therapeutic INR can be achieved more rapidly by administration of low doses of sublingual vitamin K. A vitamin K dose of 1 mg is usually adequate for patients with an INR between 4.9 and 9, whereas 2–3 mg can be used for those with an INR >9. Higher doses of vitamin K can be administered if more rapid reversal of the INR is required or if the INR is excessively high.

Patients with serious bleeding need more aggressive treatment. These patients should be given 10 mg of vitamin K by slow IV infusion. Additional vitamin K should be given until the INR is in the normal range. Treatment with vitamin K should be supplemented with fresh-frozen plasma as a source of the vitamin K–dependent clotting proteins. For life-threatening bleeds, or if patients cannot tolerate the volume load, recombinant factor VIIa or prothrombin complex concentrates can be used.

Warfarin-treated patients who experience bleeding when their INR is in the therapeutic range require investigation into the cause of the bleeding. Those with gastrointestinal bleeding often have underlying peptic ulcer disease or a tumor. Similarly, investigation of hematuria or uterine bleeding in patients with a therapeutic INR may unmask a tumor of the genitourinary tract.

### Skin Necrosis

A rare complication of warfarin, skin necrosis usually is seen 2–5 days after initiation of therapy. Well-demarcated erythematous lesions form on the thighs, buttocks, breasts, or toes. Typically, the center of the lesion becomes progressively necrotic. Examination of skin biopsies taken from the border of these lesions reveals thrombi in the microvasculature.

Warfarin-induced skin necrosis is seen in patients with congenital or acquired deficiencies of protein C or protein S. Initiation of warfarin therapy in these patients produces a precipitous fall in plasma levels of proteins C or S, thereby eliminating this important anticoagulant pathway before warfarin exerts an antithrombotic effect through lowering of the functional levels of factor X and prothrombin. The resultant procoagulant state triggers thrombosis. Why the thrombosis is localized to the microvasculature of fatty tissues is unclear.

Treatment involves discontinuation of warfarin and reversal with vitamin K, if needed. An alternative anticoagulant, such as heparin or LMWH, should be given in patients with thrombosis. Protein C concentrates or recombinant activated protein C can be given to protein C–deficient patients to accelerate healing of the skin lesions; fresh-frozen plasma may be of value for those with protein S deficiency. Occasionally, skin grafting is necessary when there is extensive skin loss.

Because of the potential for skin necrosis, patients with known protein C or protein S deficiency require overlapping treatment with a parenteral anticoagulant when initiating warfarin therapy. Warfarin should be started in low doses in these patients, and the parenteral anticoagulant should be continued until the INR is therapeutic for at least 2 to 3 consecutive days.

### Pregnancy

Warfarin crosses the placenta and can cause fetal abnormalities or bleeding. The fetal abnormalities include a

## ROLE OF FIBRINOLYTIC THERAPY

characteristic embryopathy, which consists of nasal hypoplasia and stippled epiphyses. The risk of embryopathy is highest if warfarin is given in the first trimester of pregnancy. Central nervous system abnormalities can also occur with exposure to coumarins at any time during pregnancy. Finally, maternal administration of warfarin produces an anticoagulant effect in the fetus that can cause bleeding. This is of particular concern at delivery when trauma to the head during passage through the birth canal can lead to intracranial bleeding. Because of these potential problems, warfarin is contraindicated in pregnancy, particularly in the first and third trimesters. Instead, heparin, LMWH, or fondaparinux can be given during pregnancy for prevention or treatment of thrombosis.

Warfarin does not pass into the breast milk. Consequently, warfarin can safely be given to nursing mothers.

### Special Problems

Patients with a lupus anticoagulant or those who need urgent or elective surgery present special challenges. Although observational studies suggested that patients with thrombosis complicating the antiphospholipid antibody syndrome required higher intensity warfarin regimens to prevent recurrent thromboembolic events, two randomized trials showed that targeting an INR of 2.0–3.0 is as effective as higher intensity treatment and produces less bleeding. Monitoring warfarin therapy can be problematic in patients with antiphospholipid antibody syndrome if the lupus anticoagulant prolongs the baseline INR.

If patients receiving long-term warfarin treatment require an elective invasive procedure, warfarin can be stopped 5 days before the procedure to allow the INR to return to normal levels. Those at high risk for recurrent thrombosis can be bridged with once- or twice-daily SC injections of LMWH when the INR falls to <2.0. The last dose of LMWH should be given 12–24 h before the procedure, depending on whether LMWH is administered twice or once daily. After the procedure, treatment with warfarin can be restarted.

### New Oral Anticoagulants

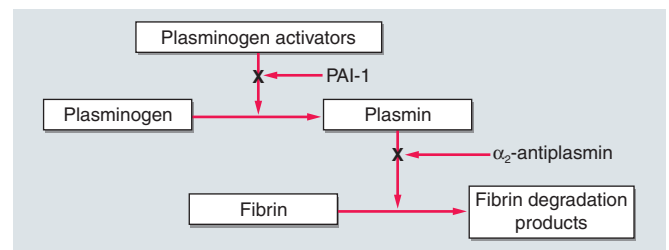
New oral anticoagulants that target thrombin or factor Xa are under development. These drugs have a rapid onset of action and have half-lives that permit once- or twice-daily administration. Designed to produce a predictable level of anticoagulation, these new oral agents can be given in fixed doses without coagulation monitoring. Therefore, these drugs will be more convenient to administer than warfarin. The results of ongoing phase II and III clinical trials will determine the role of these new oral anticoagulants in the prevention and treatment of thrombosis.

Fibrinolytic drugs can be used to degrade thrombi and are administered systemically or can be delivered via catheters directly into the substance of the thrombus. Systemic delivery is used for treatment of acute MI, acute ischemic stroke, and most cases of massive PE. The goal of therapy is to produce rapid thrombus dissolution, thereby restoring antegrade blood flow. In the coronary circulation, restoration of blood flow reduces morbidity and mortality by limiting myocardial damage, whereas in the cerebral circulation, rapid thrombus dissolution decreases the neuronal death and brain infarction that produce irreversible brain injury. For patients with massive PE, the goal of thrombolytic therapy is to restore pulmonary artery perfusion.

Peripheral arterial thrombi and thrombi in the proximal deep veins of the leg are most often treated using catheter-directed thrombolytic therapy. Catheters with multiple side holes can be used to enhance drug delivery. In some cases, intravascular devices that fragment and extract the thrombus are used to hasten treatment. These devices can be used alone or in conjunction with fibrinolytic drugs.

## MECHANISM OF ACTION

Currently approved fibrinolytic agents include streptokinase; acylated plasminogen streptokinase activator complex (anistreplase); urokinase; recombinant tissue-type plasminogen activator (rt-PA), which is also known as alteplase or Activase; and two recombinant derivatives of rt-PA, tenecteplase and reteplase. All of these agents act by converting the proenzyme, plasminogen, to plasmin, the active enzyme (Fig. 22-7). Plasmin then degrades the fibrin matrix of thrombi and produces soluble fibrin degradation products.



**FIGURE 22-7**

**The fibrinolytic system and its regulation.** Plasminogen activators convert plasminogen to plasmin. Plasmin then degrades fibrin into soluble fibrin degradation products. The system is regulated at two levels. Type 1 plasminogen activator inhibitor (PAI-1) regulates the plasminogen activators, whereas  $\alpha_2$ -antiplasmin serves as the major inhibitor of plasmin.



Endogenous fibrinolysis is regulated at two levels. Plasminogen activator inhibitors, particularly the type 1 form (PAI-1), prevent excessive plasminogen activation by regulating the activity of t-PA and urokinase-type plasminogen activator (u-PA). Once plasmin is generated, it is regulated by plasmin inhibitors, the most important of which is  $\alpha_2$ -antiplasmin. The plasma concentration of plasminogen is twofold higher than that of  $\alpha_2$ -antiplasmin. Consequently, with pharmacologic doses of plasminogen activators, the concentration of plasmin that is generated can exceed that of  $\alpha_2$ -antiplasmin. In addition to degrading fibrin, unregulated plasmin can also degrade fibrinogen and other clotting factors. This process, which is known as the *systemic lytic state*, reduces the hemostatic potential of the blood and increases the risk of bleeding.

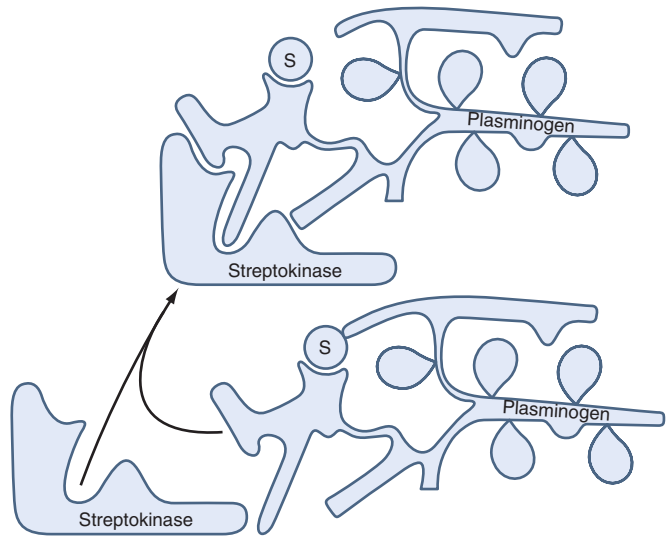
The endogenous fibrinolytic system is geared to localize plasmin generation to the fibrin surface. Both plasminogen and t-PA bind to fibrin to form a ternary complex that promotes efficient plasminogen activation. In contrast to free plasmin, plasmin generated on the fibrin surface is relatively protected from inactivation by  $\alpha_2$ -antiplasmin, a feature that promotes fibrin dissolution. Furthermore, C-terminal lysine residues exposed as plasmin degrades fibrin serve as binding sites for additional plasminogen and t-PA molecules. This creates a positive feedback that enhances plasmin generation. When used pharmacologically, the various plasminogen activators capitalize on these mechanisms to a lesser or greater extent.

Plasminogen activators that preferentially activate fibrin-bound plasminogen are considered fibrin-specific. In contrast, nonspecific plasminogen activators do not discriminate between fibrin-bound and circulating plasminogen. Activation of circulating plasminogen results in the generation of unopposed plasmin that can trigger the systemic lytic state. Alteplase and its derivatives are fibrin-specific plasminogen activators, whereas streptokinase, anistreplase, and urokinase are nonspecific agents.

## STREPTOKINASE

Unlike other plasminogen activators, streptokinase is not an enzyme and does not directly convert plasminogen to plasmin. Instead, streptokinase forms a 1:1 stoichiometric complex with plasminogen. Formation of this complex induces a conformational change in plasminogen that exposes its active site (Fig. 22-8). This conformationally altered plasminogen then converts additional plasminogen molecules to plasmin.

Streptokinase has no affinity for fibrin, and the streptokinase-plasminogen complex activates both free and fibrin-bound plasminogen. Activation of circulating plasminogen generates sufficient amounts of plasmin to overwhelm  $\alpha_2$ -antiplasmin. Unopposed plasmin not only degrades fibrin in the occlusive thrombus but also induces a systemic lytic state.



**FIGURE 22-8**

**Mechanism of action of streptokinase.** Streptokinase binds to plasminogen and induces a conformational change in plasminogen that exposes its active site. The streptokinase/plasmin(ogen) complex then serves as the activator of additional plasminogen molecules.

When given systemically to patients with acute MI, streptokinase reduces mortality. For this indication, the drug is usually given as an IV infusion of 1.5 million units over 30–60 min. Patients who receive streptokinase can develop antibodies against the drug, as can patients with prior streptococcal injection. These antibodies can reduce the effectiveness of streptokinase.

Allergic reactions occur in ~5% of patients treated with streptokinase. These may manifest as a rash, fever, chills, and rigors. Although anaphylactic reactions can occur, these are rare. Transient hypotension is common with streptokinase and has been attributed to plasmin-mediated release of bradykinin from kallikrein. The hypotension usually responds to leg elevation and administration of IV fluids and low-doses of vasopressors, such as dopamine or norepinephrine.

## ANISTREPLASE

To generate this drug, streptokinase is combined with equimolar amounts of Lys-plasminogen, a plasmin-cleaved form of plasminogen with a Lys residue at its N terminus. The active site of Lys-plasminogen that is exposed upon combination with streptokinase is then masked with an anisoyl group. After IV infusion, the anisoyl group is slowly removed by deacylation, giving the complex a half-life of ~100 min. This allows drug administration via a single bolus infusion.

Although it is more convenient to administer, anistreplase offers few mechanistic advantages over streptokinase. Like streptokinase, anistreplase does not distinguish between fibrin-bound and circulating plasminogen. Consequently, it too produces a systemic lytic state. Likewise,

allergic reactions and hypotension are just as frequent with anistreplase as they are with streptokinase.

When anistreplase was compared with alteplase in patients with acute MI, reperfusion was obtained more rapidly with alteplase than with anistreplase. Improved reperfusion was associated with a trend toward better clinical outcomes and reduced mortality with alteplase. These results and the high cost of anistreplase have dampened the enthusiasm for its use.

## UROKINASE

Urokinase is a two-chain serine protease derived from cultured fetal kidney cells with a molecular weight of 34,000. Urokinase converts plasminogen to plasmin directly by cleaving the Arg560-Val561 bond. Unlike streptokinase, urokinase is not immunogenic and allergic reactions are rare. Urokinase produces a systemic lytic state because it does not discriminate between fibrin-bound and circulating plasminogen.

Despite many years of use, urokinase has never been systemically evaluated for coronary thrombolysis. Instead, urokinase is often employed for catheter-directed lysis of thrombi in the deep veins or the peripheral arteries. Because of production problems, the availability of urokinase is limited.

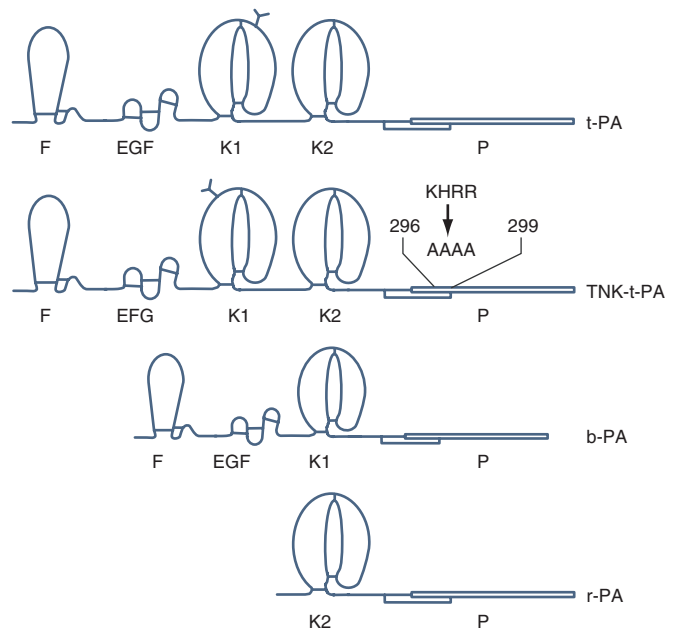
## ALTEPLASE

A recombinant form of single-chain t-PA, alteplase has a molecular weight of 68,000. Alteplase is rapidly converted into its two-chain form by plasmin. Although single- and two-chain forms of t-PA have equivalent activity in the presence of fibrin, in its absence, single-chain t-PA has tenfold lower activity.

Alteplase consists of five discrete domains (**Fig. 22-9**); the N-terminal A chain of two-chain alteplase contains four of these domains. Residues 4 through 50 make up the finger domain, a region that resembles the finger domain of fibronectin; residues 50 through 87 are homologous with epidermal growth factor, whereas residues 92 through 173 and 180 through 261, which have homology to the kringle domains of plasminogen, are designated as the first and second kringle, respectively. The fifth alteplase domain is the protease domain; it is located on the C-terminal B chain of two-chain alteplase.

The interaction of alteplase with fibrin is mediated by the finger domain and, to a lesser extent, by the second kringle domain. The affinity of alteplase for fibrin is considerably higher than that for fibrinogen. Consequently, the catalytic efficiency of plasminogen activation by alteplase is two to three orders of magnitude higher in the presence of fibrin than in the presence of fibrinogen. This phenomenon helps to localize plasmin generation to the fibrin surface.

Although alteplase preferentially activates plasminogen in the presence of fibrin, alteplase is not as fibrin-



**FIGURE 22-9**  
**Domain structures of alteplase (t-PA), tenecteplase (TNK-t-PA), desmoteplase (b-PA), and reteplase (r-PA).** The finger (F), epidermal growth factor (EGF), first and second kringles (K1 and K2, respectively), and protease (P) domains are illustrated. The glycosylation site (Y) on K1 has been repositioned in tenecteplase to endow it with a longer half-life. In addition, a tetra-alanine substitution in the protease domain renders tenecteplase resistant to PAI-1 inhibition. Desmoteplase differs from alteplase and tenecteplase in that it lacks a K2 domain. Reteplase is a truncated variant that lacks the F, EGF, and K1 domains.

selective as was first predicted. Its fibrin specificity is limited because like fibrin, (DD)E, the major soluble degradation product of cross-linked fibrin, binds alteplase and plasminogen with high affinity. Consequently, (DD)E is as potent as fibrin as a stimulator of plasminogen activation by alteplase. Whereas plasmin generated on the fibrin surface results in thrombolysis, plasmin generated on the surface of circulating (DD)E degrades fibrinogen. Fibrinogenolysis results in the accumulation of fragment X, a high-molecular-weight clottable fibrinogen degradation product. Incorporation of fragment X into hemostatic plugs formed at sites of vascular injury renders them susceptible to lysis. This phenomenon may contribute to alteplase-induced bleeding.

A trial comparing alteplase with streptokinase for treatment of patients with acute MI demonstrated significantly lower mortality with alteplase than with streptokinase, although the absolute difference was small. The greatest benefit was seen in patients <75 years of age with anterior MI who presented <6 h after symptom onset.

For treatment of acute MI or acute ischemic stroke, alteplase is given as an IV infusion over 60–90 min. The total dose of alteplase usually ranges from 90–100 mg. Allergic reactions and hypotension are rare, and alteplase is not immunogenic.

Tenecteplase is a genetically engineered variant of t-PA and was designed to have a longer half-life than t-PA and to be resistant to inactivation by PAI-1. To prolong its half-life, a new glycosylation site was added to the first kringle domain (Fig. 22-9). Because addition of this extra carbohydrate side chain reduced fibrin affinity, the existing glycosylation site on the first kringle domain was removed. To render the molecule resistant to inhibition by PAI-1, a tetra-alanine substitution was introduced at residues 296–299 in the protease domain, the region responsible for the interaction of t-PA with PAI-1.

Tenecteplase is more fibrin-specific than t-PA. Although both agents bind to fibrin with similar affinity, the affinity of tenecteplase for (DD)E is significantly lower than that of t-PA. Consequently, (DD)E does not stimulate systemic plasminogen activation by tenecteplase to the same extent as t-PA. As a result, tenecteplase produces less fibrinogenolysis than t-PA.

For coronary thrombolysis, tenecteplase is given as a single IV bolus. In a large phase III trial that enrolled >16,000 patients, the 30-day mortality rate with single-bolus tenecteplase was similar to that with accelerated dose t-PA. Although rates of intracranial hemorrhage were also similar with both treatments, patients given tenecteplase had fewer noncerebral bleeds and a reduced need for blood transfusions than those treated with t-PA. The improved safety profile of tenecteplase likely reflects its enhanced fibrin specificity.

## RETEPLASE

Retepase is a recombinant t-PA derivative and is a single-chain variant that lacks the finger, epidermal growth factor, and first kringle domains (Fig. 22-9). This truncated derivative has a molecular weight of 39,000. Retepase binds fibrin more weakly than t-PA because it lacks the finger domain. Because it is produced in *Escherichia coli*, reteplase is not glycosylated. This endows it with a plasma half-life longer than that of t-PA. Consequently, reteplase is given as two IV boluses, which are separated by 30 min. Clinical trials have demonstrated that reteplase is at least as effective as streptokinase for treatment of acute MI, but the agent is not superior to t-PA.

## NEW FIBRINOLYTIC AGENTS

Several new drugs are under investigation. These include desmoteplase (Fig. 22-9), a recombinant form of the full-length plasminogen activator isolated from the saliva of the vampire bat, and alfineprase, a truncated form of fibrolase, an enzyme isolated from the venom of the southern copperhead snake. Desmoteplase, which is more fibrin-specific than t-PA, is being investigated for the

treatment of acute ischemic stroke. With a potential for enhanced safety, desmoteplase may extend the window for treatment beyond 3 h. An ongoing phase III clinical trial is exploring this possibility. Alfineprase is a metallo-proteinase that degrades fibrin in a plasmin-independent fashion. Because of its unique mechanism of action, it was hoped that alfineprase would provide more rapid degradation of thrombi. However, a phase III trial investigating the use of this agent in patients with peripheral arterial occlusion has been halted, at least temporarily. Therefore, the future of this drug is uncertain.

## CONCLUSIONS AND FUTURE DIRECTIONS

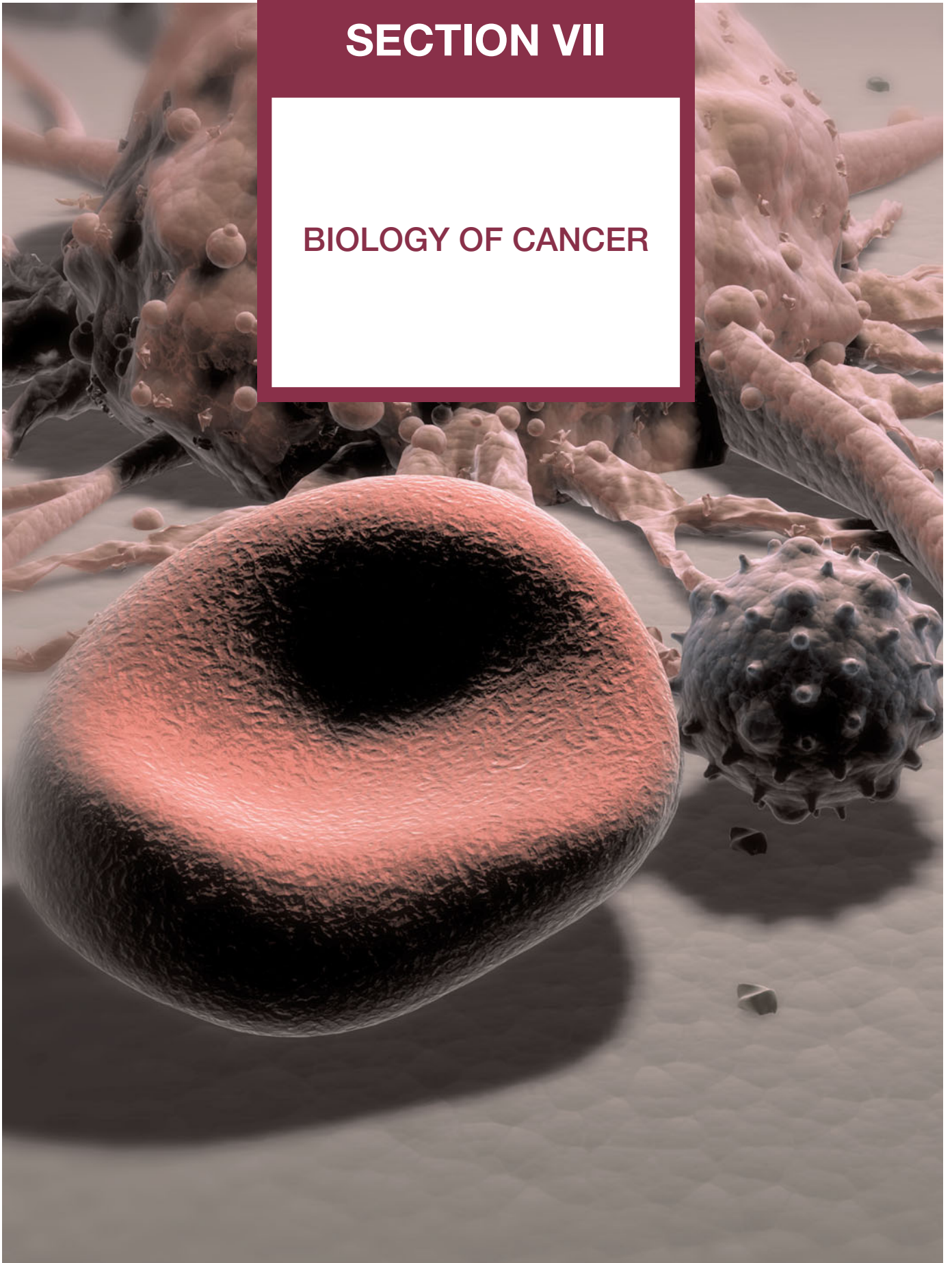
Arterial and venous thromboses reflect a complex interplay among the vessel wall, platelets, the coagulation system, and the fibrinolytic pathways. Activation of coagulation also triggers inflammatory pathways that may contribute to thrombogenesis. A better understanding of the biochemistry of blood coagulation and advances in structure-based drug design have identified new targets and resulted in the development of novel antithrombotic drugs. Well-designed clinical trials have provided detailed information on which drugs to use and when to use them. Despite these advances, however, thromboembolic disorders remain a major cause of morbidity and mortality. Therefore, the search for better targets and more potent antiplatelet, anticoagulant, and fibrinolytic drugs continues.

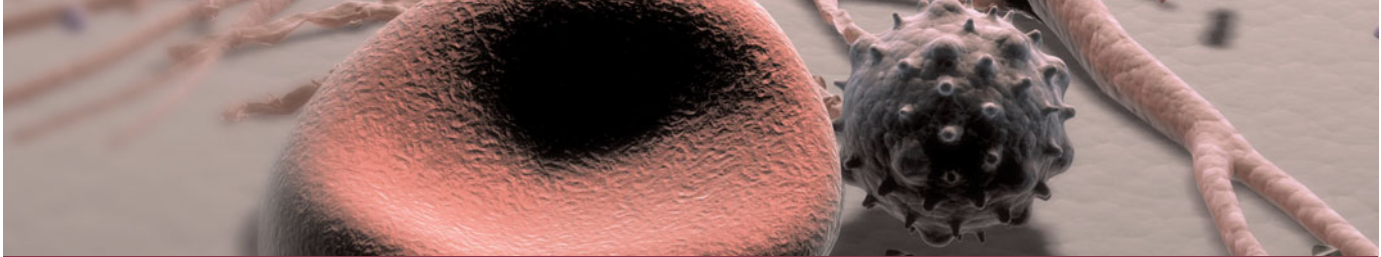
## FURTHER READINGS

- ALIKHAN R, COHEN AT: Heparin for the prevention of venous thromboembolism in general medical patients (excluding stroke and myocardial infarction). *Cochrane Database Syst Rev* CD003747, 2009
- GROSS PL, WEITZ JI: New antithrombotic drugs. *Clin Pharmacol Ther* 86:139, 2009
- HOLMES DR Jr et al: Combining antiplatelet and anticoagulant therapies. *J Am Coll Cardiol* 54:95, 2009
- KAMALI F: Genetic influences on the response to warfarin. *Curr Opin Hematol* 13:357, 2006
- KEELING D et al: The management of heparin-induced thrombocytopenia. *Br J Haematol* 133:259, 2006
- LIM W et al: Management of antiphospholipid antibody syndrome: A systematic review. *JAMA* 295:1050, 2006
- MARDER VJ: Thrombolytic therapy for deep vein thrombosis: potential application of plasmin. *Thromb Res* 123 (suppl 4):S56, 2009
- MEADOWS TA, BHATT DL: Clinical aspects of platelet inhibitors and thrombus formation. *Circ Res* 100:1261, 2007
- PALARETI G et al: D-Dimer testing to determine the duration of anticoagulation therapy. *N Engl J Med* 355:1780, 2006
- SEGAL JB et al: Management of venous thromboembolism: A systematic review for a practice guideline. *Ann Intern Med* 146:211, 2007
- SIMIONI P, TORMENE D: Inherited thrombophilia and venous thromboembolism. *Semin Thromb Hemost* 32:700, 2006
- YUSUF S, MEHTA SR: Comparison of fondaparinux and enoxaparin in acute coronary syndromes. *N Engl J Med* 354:1464, 2006

# SECTION VII

## BIOLOGY OF CANCER





# CHAPTER 23

## CANCER GENETICS

Pat J. Morin ■ Jeffrey M. Trent ■ Francis S. Collins ■ Bert Vogelstein

<p>Cancer is a Genetic Disease .....284</p> <p>Historical Perspective .....284</p> <p>The Clonal Origin and Multistep Nature of Cancer .....284</p> <p>General Classes of Cancer Genes .....285</p> <p>Mechanisms of Tumor-Suppressor Inactivation .....286</p> <p>Familial Cancer Syndromes .....286</p> <p>Genetic Testing for Familial Cancer .....288</p> <p>Oncogenes in Human Cancer .....289</p>	<p>Mechanisms of Oncogene Activation .....289</p> <p>Chromosomal Instability in Solid Tumors .....292</p> <p>Viruses in Human Cancer .....292</p> <p>Epigenetic Regulation of Gene Expression in Cancer .....292</p> <p>Gene Expression and Mutational Profiling in Cancer .....292</p> <p>The Future .....293</p> <p>■ Further Readings .....293</p>
---	---

### CANCER IS A GENETIC DISEASE

Cancer arises through a series of somatic alterations in DNA that result in unrestrained cellular proliferation. Most of these alterations involve actual sequence changes in DNA (i.e., mutations). They may arise as a consequence of random replication errors, exposure to carcinogens (e.g., radiation), or faulty DNA repair processes. Although most cancers arise sporadically, familial clustering of cancers occurs in certain families that carry a germline mutation in a cancer gene.

### HISTORICAL PERSPECTIVE

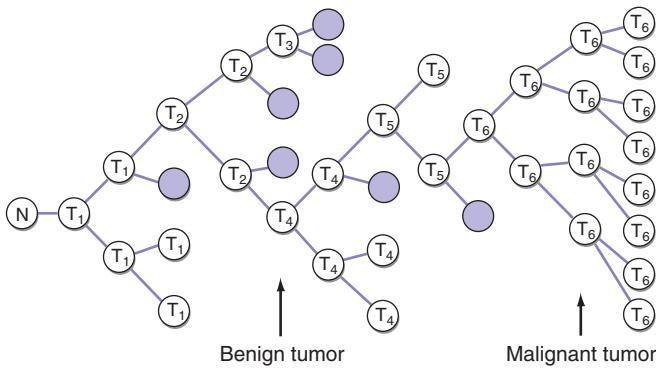
The idea that cancer progression is driven by sequential somatic mutations in specific genes has only gained general acceptance in the past 25 years. Before the advent of the microscope, cancer was believed to be composed of aggregates of mucus or other noncellular matter. By the middle of the nineteenth century, it became clear that tumors were masses of cells and that these cells arose from the normal cells of the tissue in which the cancer originated. However, the molecular basis for the uncontrolled proliferation of cancer cells was to remain a mystery for another century. During that time, a number of theories for the origin of cancer were postulated. The great biochemist Otto Warburg proposed the combustion theory of cancer, which stipulated that cancer was due to abnormal oxygen metabolism: whereas normal cells required oxygen, cancer cells could survive in its

absence. In addition, some believed that all cancers were caused by viruses and that cancer was in fact a contagious disease.

In the end, observations of cancer occurring in chimney sweeps, studies of x-rays, and the overwhelming data demonstrating cigarette smoke as a causative agent in lung cancer, together with Ames's work on chemical mutagenesis, were sufficient to convince many people that cancer originates through changes in DNA. Although the viral theory of cancer did not prove to be generally accurate, the study of retroviruses led to the discovery of the first human *oncogenes* in the mid to late 1970s. Soon after, the study of families with genetic predisposition to cancer was instrumental in the discovery of *tumor-suppressor genes*. The field that studies the type of mutations, as well as the consequence of these mutations in tumor cells, is now known as *cancer genetics*.

### THE CLONAL ORIGIN AND MULTISTEP NATURE OF CANCER

Nearly all cancers originate from a single cell; this clonal origin is a critical discriminating feature between neoplasia and hyperplasia. Multiple cumulative mutational events are invariably required for the progression from normal to fully malignant phenotype. The process can be seen as Darwinian microevolution in which, at each successive step, the mutated cells gain a growth advantage resulting in an increased representation relative to their

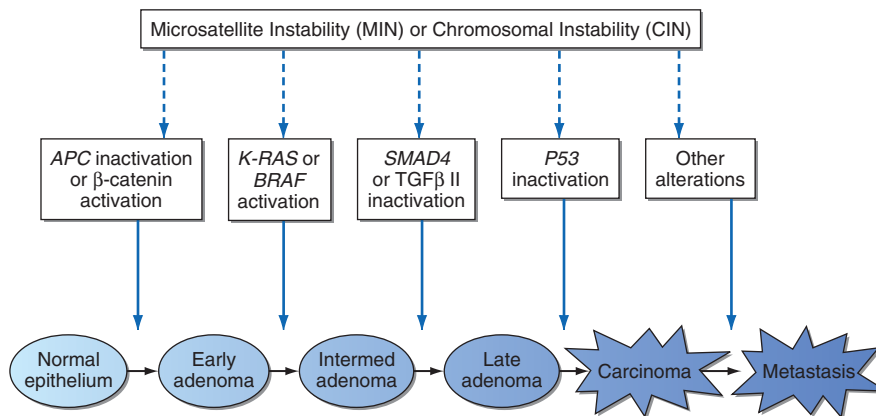


**FIGURE 23-1**

**Multistep clonal development of malignancy.** In this diagram a series of five cumulative mutations (T1, T2, T4, T5, T6), each with a modest growth advantage acting alone, eventually results in a malignant tumor. Note that not all such alterations result in progression; for example, the T3 clone is a dead end. The actual number of cumulative mutations necessary to transform from the normal to the malignant state is unknown in most tumors. (After P Nowell, *Science* 194:23, 1976, with permission.)

neighbors (Fig. 23-1). It is believed that five to ten accumulated mutations are necessary for a cell to progress from the normal to the fully malignant phenotype.

We are beginning to understand the precise nature of the genetic alterations responsible for some malignancies and to get a sense of the order in which they occur. The best studied example is colon cancer, in which analyses of DNA from tissues extending from normal colon epithelium through adenoma to carcinoma have identified some of the genes mutated in the process (Fig. 23-2). Similar progression models are being elucidated for other malignancies.



**FIGURE 23-2**

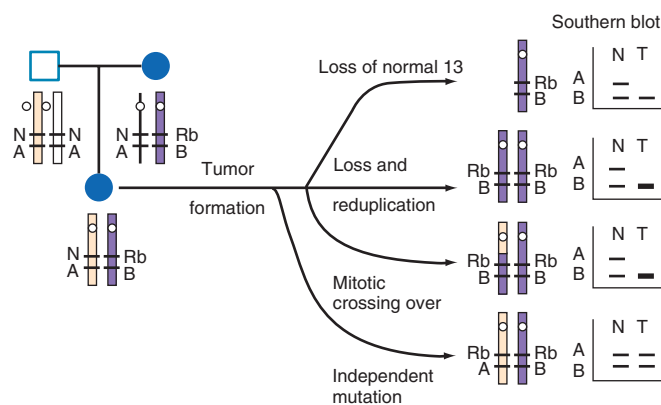
**Progressive somatic mutational steps in the development of colon carcinoma.** The accumulation of alterations in a number of different genes results in the progression from normal epithelium through adenoma to full-blown carcinoma. Genetic instability (microsatellite or chromosomal) accelerates

There are two major classes of cancer genes. The first class comprises genes that directly affect cell growth either positively (*oncogenes*) or negatively (*tumor-suppressor genes*). These genes exert their effects on tumor growth through their ability to control cell division (cell birth) or cell death (apoptosis). Oncogenes are tightly regulated in normal cells. In cancer cells, oncogenes acquire mutations that relieve this control and lead to increased activity of the gene product. This mutational event typically occurs in a single allele of the oncogene and acts in a dominant fashion. In contrast, the normal function of tumor-suppressor genes is to restrain cell growth, and this function is lost in cancer. Because of the diploid nature of mammalian cells, both alleles must be inactivated to completely lose the function of a tumor-suppressor gene, leading to a recessive mechanism at the cellular level. From these ideas and studies on the inherited form of retinoblastoma, Knudson and others formulated the *two-hit hypothesis*, which in its modern version states that both copies of a tumor-suppressor gene must be inactivated in cancer.

The second class of cancer genes, the *caretakers*, does not directly affect cell growth but rather affects the ability of the cell to maintain the integrity of its genome. Cells with deficiency in these genes have an increased rate of mutations in all the genes, including oncogenes and tumor-suppressor genes. This “mutator” phenotype was first hypothesized by Loeb to explain how the multiple mutational events required for tumorigenesis can occur in the lifetime of an individual. A mutation phenotype has now been observed in cancer at both the nucleotide sequence and chromosomal levels.

the progression by increasing the likelihood of mutation at each step. Patients with familial polyposis are already one step into this pathway because they inherit a germline alteration of the APC gene. TGF, transforming growth factor.

The two major types of somatic lesions observed in tumor-suppressor genes during tumor development are *point mutations* and *large deletions*. Point mutations in the coding region of tumor-suppressor genes frequently lead to truncated protein products or otherwise non-functional proteins. Similarly, deletions lead to the loss of a functional product and sometimes encompass the entire gene or even the entire chromosome arm, leading to loss of heterozygosity (LOH) in the tumor DNA compared to the corresponding normal tissue DNA (Fig. 23-3). LOH in tumor DNA is considered a hallmark for the presence of a tumor-suppressor gene at a particular locus, and LOH studies have been useful in the positional cloning of many tumor-suppressor genes. Gene silencing, which occurs in conjunction with hypermethylation of the promoter, is another mechanism of tumor-suppressor gene inactivation. Silencing is an epigenetic change rather than a sequence alteration.



**FIGURE 23-3**

**Diagram of possible mechanisms for tumor formation** in an individual with hereditary (familial) retinoblastoma. On the left is shown the pedigree of an affected individual who has inherited the abnormal (Rb) allele from her affected mother. The four chromosomes of her two parents are drawn to indicate their origin. Just below the retinoblastoma locus a polymorphic marker is also analyzed in this family. The patient is AB at this locus, like her mother, whereas her father is AA. Thus the B allele must be on the chromosome carrying the retinoblastoma disease gene. Tumor formation results when the normal allele (N), which this patient inherited from her father, is inactivated. On the right are shown four possible ways in which this could occur. In each case, the resulting chromosome 13 arrangement is shown, as well as the results of a Southern blot comparing normal tissue with tumor tissue. Note that in the first three situations the normal allele (A) has been lost in the tumor tissue, which is referred to as loss of heterozygosity (LOH). (From TD Gelehrter and FS Collins, in *Principles of Medical Genetics*, Baltimore, Williams and Wilkins, 1990, with permission.)

## FAMILIAL CANCER SYNDROMES

A small fraction of cancers occur in patients with a genetic predisposition. In these families, the affected individuals have a predisposing loss-of-function mutation in one allele of a tumor-suppressor gene or caretaker gene. The tumors in these patients show a loss of the remaining normal allele as a result of somatic events (point mutations or deletions), in agreement with the Knudson hypothesis (Fig. 23-3). Thus most cells of an individual with an inherited loss-of-function mutation in a tumor-suppressor gene are functionally normal, and only the rare cells that develop a mutation in the remaining normal allele exhibit uncontrolled growth. The normal function of tumor suppressors is to restrain growth, to promote differentiation (gatekeeper genes), or to preserve genome integrity (caretaker genes).

Roughly 100 syndromes of familial cancer have been reported, although many are rare. Most are inherited as autosomal dominant traits, although some of those associated with DNA repair abnormalities (xeroderma pigmentosum, Fanconi's anemia, ataxia telangiectasia) are autosomal recessive. Table 23-1 shows a number of cancer predisposition syndromes and the responsible genes. The current paradigm states that the genes mutated in familial syndromes can also be targets for somatic mutations in sporadic (noninherited) tumors. The study of cancer syndromes has thus provided invaluable insights into the mechanisms of progression for many tumor types. This section examines the case of inherited colon cancer in detail, but the same general lessons can be applied to all the cancer syndromes listed in Table 23-1.

Familial adenomatous polyposis (FAP) is a dominantly inherited colon cancer syndrome due to germline mutations in the adenomatous polyposis coli (*APC*) tumor-suppressor gene on chromosome 5. Patients with this syndrome develop hundreds to thousands of adenomas in the colon. Each of these adenomas has lost the normal remaining allele of *APC* but has not yet accumulated the required additional mutations to generate fully malignant cells (Fig. 23-2). However, out of these thousands of benign adenomas, several will invariably acquire further abnormalities and a subset will even develop into fully malignant cancers. *APC* is thus considered to be a gatekeeper for colon tumorigenesis; Fig. 23-4 shows germline and somatic mutations found in the *APC* gene. The function of the *APC* protein is still not completely understood but likely provides differentiation and apoptotic cues to colonic cells as they migrate up the crypts. Defects in this process may lead to abnormal accumulation of cells that should normally undergo apoptosis and slough off.

In contrast to FAP, patients with hereditary nonpolyposis colon cancer (HNPCC, or Lynch's syndrome) do not develop multiple polyposis but instead develop only one or a small number of adenomas that rapidly progress

TABLE 23-1

CANCER PREDISPOSITION SYNDROMES AND ASSOCIATED GENES				
SYNDROME	GENE	CHROMOSOME	INHERITANCE	TUMORS
Ataxia telangiectasia	<i>ATM</i>	11q22-q23	AR	Breast cancer
Autoimmune lymphoproliferative syndrome	<i>FAS</i> <i>FASL</i>	10q24 1q23	AD	Lymphomas
Bloom's syndrome	<i>BLM</i>	15q26.1	AR	Cancer of all types
Cowden's syndrome	<i>PTEN</i>	10q23	AD	Breast, thyroid
Familial adenomatous polyposis	<i>APC</i>	5q21	AD	Intestinal adenoma, colorectal cancer
Familial melanoma	<i>p16INK4</i>	9p21	AD	Melanoma, pancreatic cancer
Familial Wilms' tumor	<i>WT1</i>	11p13	AD	Pediatric kidney cancer
Hereditary breast/ovarian cancer	<i>BRCA1</i> <i>BRCA2</i>	17q21 13q12.3	AD	Breast, ovarian, colon, prostate
Hereditary diffuse gastric cancer	<i>CDH1</i>	16q22	AD	Stomach cancers
Hereditary multiple exostoses	<i>EXT1</i> <i>EXT2</i>	8q24 11p11-12	AD	Exostoses, chondrosarcoma
Hereditary prostate cancer	<i>HPC1</i>	1q24-25	AD	Prostate carcinoma
Hereditary retinoblastoma	<i>RB1</i>	13q14.2	AD	Retinoblastoma, osteosarcoma
Hereditary nonpolyposis colon cancer (HNPCC)	<i>MSH2</i> <i>MLH1</i> <i>MSH6</i> <i>PMS2</i>	2p16 3p21.3 2p16 7p22	AD	Colon, endometrial, ovarian, stomach, small bowel, ureter carcinoma
Hereditary papillary renal carcinoma	<i>MET</i>	7q31	AD	Papillary renal tumor
Juvenile polyposis	<i>SMAD4</i>	18q21	AD	Gastrointestinal, pancreatic cancers
Li-Fraumeni	<i>TP53</i>	17p13.1	AD	Sarcoma, breast cancer
Multiple endocrine neoplasia type 1	<i>MEN1</i>	11q13	AD	Parathyroid, endocrine, pancreas, and pituitary
Multiple endocrine neoplasia type 2a	<i>RET</i>	10q11.2	AD	Medullary thyroid carcinoma, pheochromocytoma
Neurofibromatosis type 1	<i>NF1</i>	17q11.2	AD	Neurofibroma, neurofibrosarcoma, brain tumor
Neurofibromatosis type 2	<i>NF2</i>	22q12.2	AD	Vestibular schwannoma, meningioma, spine
Nevoid basal cell carcinoma syndrome (Gorlin's syndrome)	<i>PTCH</i>	9q22.3	AD	Basal cell carcinoma, medulloblastoma, jaw cysts
Tuberous sclerosis	<i>TSC1</i> <i>TSC2</i>	9q34 16p13.3	AD	Angiofibroma, renal angiomyolipoma
Von Hippel-Lindau	<i>VHL</i>	3p25-26	AD	Kidney, cerebellum, pheochromocytoma

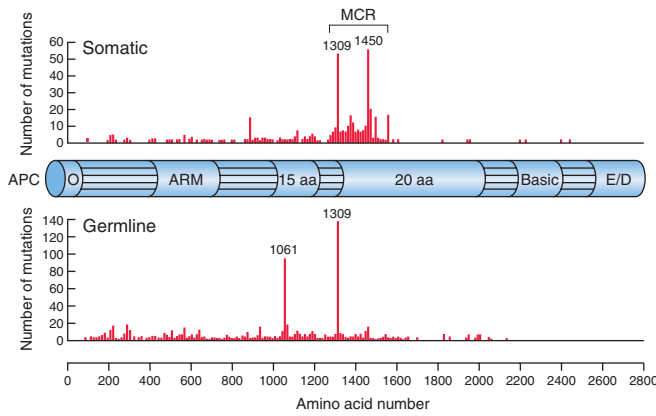
**Note:** AD, autosomal dominant; AR, autosomal recessive.

to cancer. HNPCC is commonly defined by family history, with at least three individuals over at least two generations developing colon or endometrial cancer, and with at least one individual diagnosed before the age of 50. Most HNPCC is due to mutations in one of four DNA mismatch repair genes (Table 23-1), which are components of a repair system that is normally responsible for correcting errors in freshly replicated DNA. Germline mutations in *MSH2* and *MLH1* account for >60% of HNPCC cases; mutations in *MSH6* and *PMS2* are much less frequent. When a somatic mutation inactivates the remaining wild-type allele of a mismatch repair

gene, the cell develops a hypermutable phenotype characterized by profound genomic instability, especially for the short repeated sequences called *microsatellites*. This microsatellite instability (MIN) favors the development of cancer by increasing the rate of mutations in many genes, including oncogenes and tumor-suppressor genes (Fig. 23-2). These genes can thus be considered caretakers. **Figure 23-5** shows an example of the instability in allele sizes for dinucleotide repeats in the cancers of HNPCC patients.

Although most autosomal dominant inherited cancer syndromes are due to mutations in tumor-suppressor



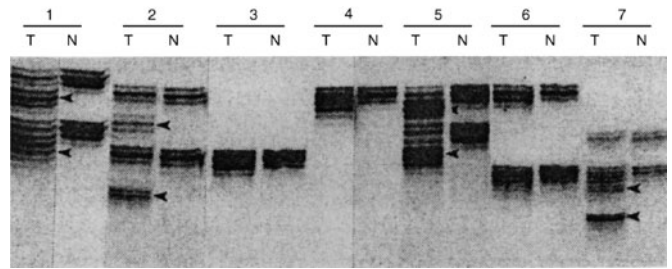


**FIGURE 23-4**

**Germline and somatic mutations in the tumor-suppressor gene APC.** APC encodes a 2843-amino-acid protein with six major domains: an oligomerization region (O), armadillo repeats (ARM), 15-amino-acid repeats (15 AA), 20-amino-acid repeats (20 AA), a basic region, and a domain involved in binding EB1 and the *Drosophila* discs large homologue (E/D). Shown are the positions within the APC gene of a total of 650 somatic and 826 germline mutations (from the APC database at <http://p53.free.fr>). The vast majority of these mutations result in the truncation of the APC protein. Germline mutations are found to be relatively evenly distributed up to codon 1600 except for two mutation hotspots at amino acids 1061 and 1309, which together account for a third of the mutations found in familial adenomatous polyposis (FAP) families. Somatic APC mutations in colon tumors cluster in an area of the gene known as the *mutation cluster region* (MCR). The location of the MCR suggests that the 20-amino-acid domain plays a crucial role in tumor suppression. Note that loss of the second functional APC allele in tumors from FAP families often occurs through loss of heterozygosity.

genes (Table 23-1), there are a few interesting exceptions. Multiple endocrine neoplasia type II, a dominant disorder characterized by pituitary adenomas, medullary carcinoma of the thyroid, and (in some pedigrees) pheochromocytoma, is due to gain-of-function mutations in the protooncogene *RET* on chromosome 10. Similarly, gain-of-function mutations in the tyrosine kinase domain of the *MET* oncogene lead to hereditary papillary renal carcinoma. Interestingly, loss-of-function mutations in the *RET* gene cause a completely different disease, Hirschsprung's disease (aganglionic megacolon).

Although the Mendelian forms of cancer have taught us much about the mechanisms of growth control, most forms of cancer do not follow simple patterns of inheritance. In many instances (e.g., lung cancer), a strong environmental contribution is at work. Even in such circumstances, however, some individuals may be more genetically susceptible to developing cancer, given the appropriate exposure, due to the presence of modifier alleles.

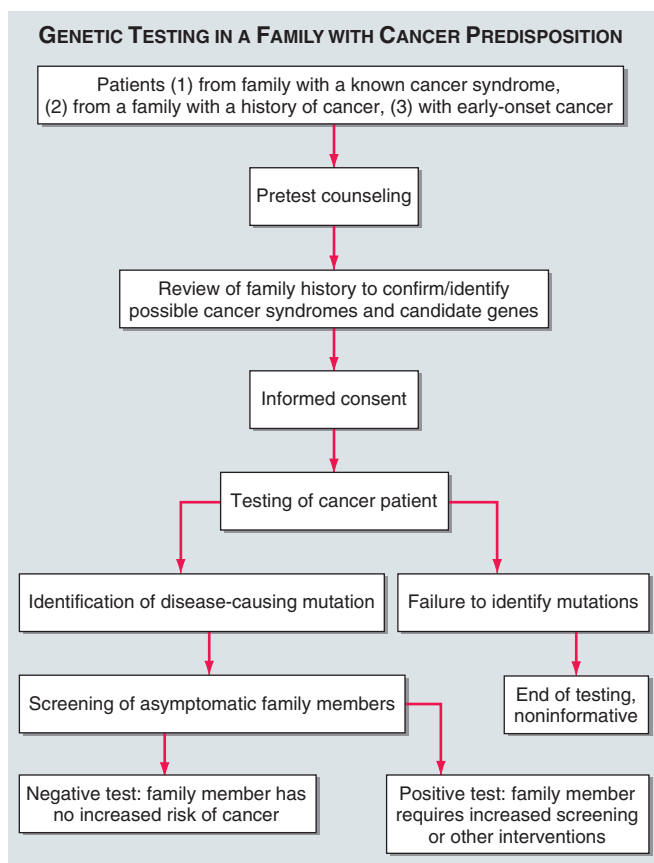


**FIGURE 23-5**

**Demonstration of microsatellite instability in normal and tumor tissue from hereditary nonpolyposis colon cancer (HNPCC) patients.** In each case the lane marked T contains DNA from a tumor, and the lane marked N contains DNA from normal tissue of the same patient. The marker (*D2S123*, located on chromosome 2) is a microsatellite composed of a tandem repeat of the dinucleotide CA, which varies in length from chromosome to chromosome. Normally, however, the length of the repeat is stable in somatic tissues. In this example, a polymerase chain reaction analysis has been applied to genomic DNA, and new alleles for the marker are apparent in tumors 1, 2, 5, and 7. Because the tumor tissue is defective in DNA mismatch repair, clonal abnormalities in copying of the CA repeat have arisen. Errors are also occurring in functional genes, eventually resulting in the malignant phenotype. (From LA Aaltonen et al, *Clues to the pathogenesis of familial colorectal cancer*. *Science* 260:812, 1993, with permission; Copyright 1993 AAAS.)

## GENETIC TESTING FOR FAMILIAL CANCER

The discovery of cancer susceptibility genes raises the possibility of DNA testing to predict the risk of cancer in individuals of affected families. An algorithm for cancer risk assessment and decision making in high-risk families using genetic testing is shown in Fig. 23-6. Once a mutation is discovered in a family, subsequent testing of asymptomatic family members can be crucial in patient management. A negative gene test in these individuals can prevent years of anxiety in the knowledge that their cancer risk is no higher than that of the general population. Or a positive test may lead to alteration of clinical management, such as increased frequency of cancer screening and, when feasible and appropriate, prophylactic surgery. Potential negative consequences of a positive test result include psychological distress (anxiety, depression) and discrimination (insurance, employment). Testing should therefore not be conducted without counseling before and after disclosure of the test result. In addition, the decision to test should depend on whether effective interventions exist for the particular type of cancer to be tested. Despite these caveats, genetic cancer testing for some cancer syndromes already appears to have greater benefits than risks, and many companies now offer testing for various genes associated with the predisposition to breast cancer (*BRCA1* and *BRCA2*), melanoma (*p16INK4*), and colon cancer (*APC* and the HNPCC genes).

**FIGURE 23-6**

**Algorithm for genetic testing in a family with cancer predisposition.** The key step is the identification of a mutation in a cancer patient, which allows testing of asymptomatic family members. Asymptomatic family members who test positive may require increased screening or surgery, whereas others are at no greater risk for cancer than the general population.

Because of the inherent problems of genetic testing such as cost, specificity, and sensitivity, it is not yet appropriate to offer these tests to the general population. However, testing may be appropriate in some subpopulations with a known increased risk, even without a defined family history. For example, two mutations in the breast cancer susceptibility gene *BRCA1*, 185delAG and 5382insC, exhibit a sufficiently high frequency in the Ashkenazi Jewish population that genetic testing of an individual of this ethnic group may be warranted.

It is important that genetic test results be communicated to families by trained genetic counselors. To ensure that the families clearly understand its advantages and disadvantages and the impact it may have on their management and psyche, genetic testing should never be done before counseling. Significant expertise is needed to communicate the results of genetic testing to families. For example, one common mistake is to misinterpret the result of negative genetic tests. For many cancer predisposition genes, the sensitivity of genetic testing is only  $\leq 70\%$  (i.e., of 100 kindreds tested, disease-causing

mutations can be identified in only 70). Therefore, such testing should in general begin with an affected member of the kindred (the youngest family member still alive who has had the cancer of interest). If a mutation is not identified in this individual, then the test should be reported as noninformative (Fig. 23-6) rather than negative (because it is possible that the mutation in this individual is not detectable by standard genetic assays for purely technical reasons). However, if a mutation can be identified in this individual, then testing of other family members can be performed, and the sensitivity of such subsequent tests will be 100% (because the mutation in the family is in this case known to be detectable by the assay methods used).

## ONCOGENES IN HUMAN CANCER

Oncogenes of the kind found in human cancers were initially discovered through their presence in the genome of retroviruses capable of causing cancers in chickens, mice, and rats. The cellular homologues of these viral genes are often targets of mutation or aberrant regulation in human cancer. Whereas many oncogenes were discovered because of their presence in retroviruses, other oncogenes, particularly those involved in translocations characteristic of particular leukemias and lymphomas, were isolated through genomic approaches. Investigators cloned the sequences surrounding the chromosomal translocations observed cytogenetically and then deduced the nature of the genes that were the targets of these translocations (see later). Some of these were oncogenes known from retroviruses [like *ABL*, involved in chronic myelogenous leukemia (CML)], whereas others were new (like *BCL2*, involved in B cell lymphoma). In the normal cellular environment, protooncogenes have crucial roles in cell proliferation and differentiation. **Table 23-2** is a partial list of oncogenes known to be involved in human cancer.

The normal growth and differentiation of cells is controlled by growth factors that bind to receptors on the surface of the cell. The signals generated by the membrane receptors are transmitted inside the cells through signaling cascades involving kinases, G proteins, and other regulatory proteins. Ultimately, these signals affect the activity of transcription factors in the nucleus, which regulate the expression of genes crucial in cell proliferation, cell differentiation, and cell death. Oncogene products have been found to function at critical steps in these pathways (Chap. 24), and inappropriate activation of these pathways can lead to tumorigenesis.

## MECHANISMS OF ONCOGENE ACTIVATION

Mechanisms that upregulate (or activate) cellular oncogenes fall into three broad categories: point mutation, DNA amplification, and chromosomal rearrangement.

COMMON ONCOGENES ALTERED IN HUMAN CANCERS

ONCOGENE	FUNCTION	ALTERATION IN CANCER	NEOPLASM
<i>AKT1</i>	Serine/threonine kinase	Amplification	Gastric carcinoma
<i>AKT2</i>	Serine/threonine kinase	Amplification	Ovarian, breast, pancreas cancer
<i>BRAF</i>	Serine/threonine kinase	Point mutation	Melanoma, lung, colorectal cancer
<i>CTNNB1</i>	Signal transduction	Point mutation	Colon, prostate, melanoma, skin, others
<i>FOS</i>	Transcription factor	Overexpression	Osteosarcomas
<i>ERBB2</i>	Receptor tyrosine kinase	Point mutation, amplification	Breast, ovary, stomach, neuroblastoma
<i>JUN</i>	Transcription factor	Overexpression	Lung cancer
<i>MET</i>	Receptor tyrosine kinase	Point mutation, rearrangement	Osteocarcinoma, kidney, glioma
<i>MYB</i>	Transcription factor	Amplification	AML, CML, colon cancer, melanoma
<i>C-MYC</i>	Transcription factor	Amplification	Breast, colon, gastric, lung
<i>L-MYC</i>	Transcription factor	Amplification	Lung carcinoma, bladder
<i>N-MYC</i>	Transcription factor	Amplification	Neuroblastoma, lung cancer
<i>HRAS</i>	GTPase	Point mutation	Colon, lung, pancreas
<i>KRAS</i>	GTPase	Point mutation	Melanoma, colorectal cancer, AML
<i>NRAS</i>	GTPase	Point mutation	Various carcinomas, melanoma
<i>REL</i>	Transcription factor	Rearrangement, amplification	Lymphomas
<i>WNT1</i>	Growth factor	Amplification	Retinoblastoma

**Note:** AML, acute myelogenous leukemia; CML, chronic myelogenous leukemia.

### Point Mutation

Point mutation is a common mechanism of oncogene activation. For example, mutations in one of the *RAS* genes (*HRAS*, *KRAS*, or *NRAS*) are present in up to 85% of pancreatic cancers and 50% of colon cancers but are relatively uncommon in other cancer types. Remarkably—and in contrast to the diversity of mutations found in tumor-suppressor genes (Fig. 23-4)—most of the activated *RAS* genes contain point mutations in codons 12, 13, or 61 (which convey resistance to GAP, a protein that interacts with *RAS* and inactivates it through substitution of the GTP cofactor with GDP). The restricted pattern of mutation compared to tumor-suppressor genes reflects the fact that gain-of-function mutations of oncogenes are more difficult to attain than simple inactivation. Indeed, inactivation of a gene can be attained through the introduction of a stop codon anywhere in the coding sequence, whereas activations require precise substitutions at residues that normally downregulate the activity of the encoded protein. The specificity of oncogene mutations provides specific diagnostic opportunities because it is much simpler to find mutations at specified positions than it is when mutations can be scattered throughout the gene (as in tumor-suppressor genes).

### DNA Amplification

The second mechanism for activation of oncogenes is DNA sequence amplification, leading to overexpression of the gene product. This increase in DNA copy number may cause cytologically recognizable chromosome

alterations referred to as *homogeneous staining regions* (HSRs), if integrated within chromosomes, or *double minutes* (dmins), if extrachromosomal in nature. The recognition of DNA amplification is accomplished through various cytogenetic techniques such as comparative genomic hybridization (CGH) and fluorescence in situ hybridization (FISH), which allow the visualization of chromosomal aberrations using fluorescent dyes. With these techniques, the entire genome can be surveyed for gains and losses of DNA sequences, thus pinpointing chromosomal regions likely to contain genes important in the development or progression of cancer. Noncytogenetic molecular techniques for identifying amplifications have more recently become available.

Numerous genes have been reported to be amplified in cancer. Several genes, including *NMYC* and *LMYC*, were identified through their presence within the amplified DNA sequences of a tumor and had homology to known oncogenes. Because the region amplified often extends to hundreds of thousands of base pairs, more than one oncogene may be amplified in some cancers (particularly sarcomas). Genes simultaneously amplified in many cases include *MDM2*, *GLI*, *CDK4*, and *SAS*. Demonstration of amplification of a cellular gene is often a predictor of poor prognosis. For example, *ERBB2/HER2* and *NMYC* are often amplified in aggressive breast cancers and neuroblastoma, respectively.

### Chromosomal Rearrangement

Chromosomal alterations provide important clues to the genetic changes in cancer. The chromosomal alterations

TABLE 23-3

## REPRESENTATIVE ONCOGENES AT CHROMOSOMAL TRANSLOCATIONS

GENE (CHROMOSOME)	TRANSLOCATION	MALIGNANCY
<i>ABL</i> (9q34.1)– <i>BCR</i> (22q11)	(9;22)(q34;q11)	Chronic myelogenous leukemia
<i>ATF1</i> (12q13)– <i>EWS</i> (22q12)	(12;22)(q13;q12)	Malignant melanoma of soft parts (MMSP)
<i>BCL1</i> (11q13.3)– <i>IgH</i> (14q32)	(11;14)(q13;q32)	Mantle cell lymphoma
<i>BCL2</i> (18q21.3)– <i>IgH</i> (14q32)	(14;18)(q32;q21)	Follicular lymphoma
<i>FLI1</i> (11q24)– <i>EWS</i> (22q12)	(11;22)(q24;q12)	Ewing's sarcoma
<i>LCK</i> (1p34)– <i>TCRB</i> (7q35)	(1;7)(p34;q35)	T cell acute lymphocytic leukemia (ALL)
<i>MYC</i> (8q24)– <i>IgH</i> (14q32)	(8;14)(q24;q32)	Burkitt's lymphoma, B cell ALL
<i>WT1</i> (11p13)– <i>EWS</i> (22q12)	(11;22)(p13;q12)	Desmoplastic small round cell tumor (DSRCT)
<i>PAX3</i> (2q35)– <i>FKHR/ALV</i> (13q14)	(2;13)(q35;q14)	Alveolar rhabdomyosarcoma
<i>PAX7</i> (1p36)– <i>KHR/ALV</i> (13q14)	(1;13)(p36;q14)	Alveolar rhabdomyosarcoma
<i>RET</i> (10q11.2)	(10;17)(q11.2;q23)	Papillary thyroid carcinomas

**Source:** From R Hesketh: *The Oncogene and Tumour Suppressor Gene Facts Book*, 2d ed. San Diego, Academic Press, 1997; with permission.

in human solid tumors such as carcinomas are heterogeneous and complex and likely reflect selection for the loss of tumor-suppressor genes on the involved chromosome. In contrast, the chromosome alterations in myeloid and lymphoid tumors are often simple translocations, i.e., reciprocal transfers of chromosome arms from one chromosome to another. Consequently, many detailed and informative chromosome analyses have been performed on hematopoietic cancers. The breakpoints of recurring chromosome abnormalities usually occur at the site of cellular oncogenes. **Table 23-3** lists representative examples of recurring chromosome alterations in malignancy and the associated gene(s) rearranged or deregulated by the chromosomal rearrangement. Translocations are particularly common in lymphoid tumors, probably because these cell types normally rearrange their DNA to generate antigen receptors. Indeed, antigen receptor genes are commonly involved in the translocations, implying that an imperfect regulation of receptor gene rearrangement may be involved in the pathogenesis. An example is Burkitt's lymphoma, a B cell tumor characterized by a reciprocal translocation between chromosomes 8 and 14. Molecular analysis of Burkitt's lymphomas demonstrated that the breakpoints occurred within or near the *MYC* locus on chromosome 8 and within the immunoglobulin heavy chain locus on chromosome 14, resulting in the transcriptional activation of *MYC*. Enhancer activation by translocation, although not universal, appears to play an important role in malignant progression. In addition to transcription factors and signal transduction molecules, translocation may result in the overexpression of cell cycle regulatory proteins such as cyclins and of proteins that regulate cell death such as *bcl-2*.

The first reproducible chromosome abnormality detected in human malignancy was the Philadelphia

chromosome detected in CML. This cytogenetic abnormality is generated by reciprocal translocation involving the *ABL* oncogene, a tyrosine kinase on chromosome 9, being placed in proximity to the *BCR* (breakpoint cluster region) on chromosome 22. **Figure 23-7** illustrates the generation of the translocation and its protein product. The consequence of expression of the *BCR-ABL* gene product is the activation of signal transduction pathways leading to cell growth independent of normal external signals. Imatinib, a drug that specifically blocks the activity of *BCR-ABL*, has shown remarkable efficacy with little toxicity in patients with CML. Knowledge of genetic alterations in cancer can lead to mechanism-based design and development of cancer drugs.

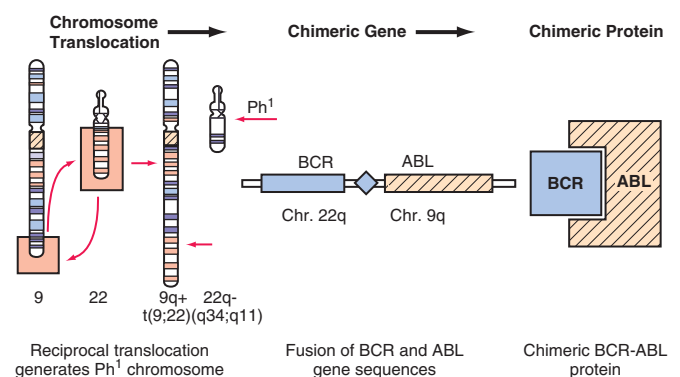


FIGURE 23-7

**Specific translocation seen in chronic myelogenous leukemia (CML).** The Philadelphia chromosome (Ph) is derived from a reciprocal translocation between chromosomes 9 and 22 with the breakpoint joining the sequences of the *ABL* oncogene with the *BCR* gene. The fusion of these DNA sequences allows the generation of an entirely novel fusion protein with modified function. (Courtesy of ER Fearon and KR Cho; with permission.)

Solid tumors are generally highly aneuploid, containing an abnormal number of chromosomes; these chromosomes also exhibit structural alterations such as translocations, deletions, and amplifications. Again, colon cancer has proven to be a particularly useful model for the study of chromosomal instability (CIN). As described earlier, some familial cases are characterized by the presence of MIN. Interestingly, MIN and CIN appear to be mutually exclusive in colon cancer, suggesting that they represent alternative mechanisms for the generation of a mutator phenotype in this cancer (Fig. 23–2). Other cancer types rarely exhibit MIN but almost always exhibit CIN. Normal cells possess several cell cycle checkpoints, often defined as quality-control requirements that have to be met before subsequent events are allowed to take place. The spindle checkpoint, which ensures proper chromosome attachment to the mitotic spindle before allowing the sister chromatids to separate, has been shown to be deficient in certain cancers. The genes that, when mutated, may cause CIN have in general not yet been identified, although a few candidates mutated in a small number of tumors have been discovered. The identification of the cause of CIN in tumors will likely be a formidable task, considering that several hundred genes are thought to control the mitotic checkpoint and other cellular processes assuring proper chromosome segregation. Regardless of the mechanisms underlying CIN, the measurement of the number of chromosomal alterations present in tumors is now possible with both cytogenetic and molecular techniques, and several studies have shown that this information can be useful for prognostic purposes.

### **VIRUSES IN HUMAN CANCER**

Certain human malignancies are associated with viruses. Examples include Burkitt's lymphoma (Epstein-Barr virus), hepatocellular carcinoma (hepatitis virus), cervical cancer [human papillomavirus (HPV)], and T cell leukemia (retroviruses). The mechanisms of action of these viruses are varied but always involve activation of growth-promoting pathways or inhibition of tumor-suppressor products in the infected cells. For example, HPV proteins E6 and E7 bind and inactivate cellular tumor suppressors p53 and pRB, respectively. Viruses are not sufficient for cancer development but constitute one alteration in the multistep process of cancer.

### **EPIGENETIC REGULATION OF GENE EXPRESSION IN CANCER**

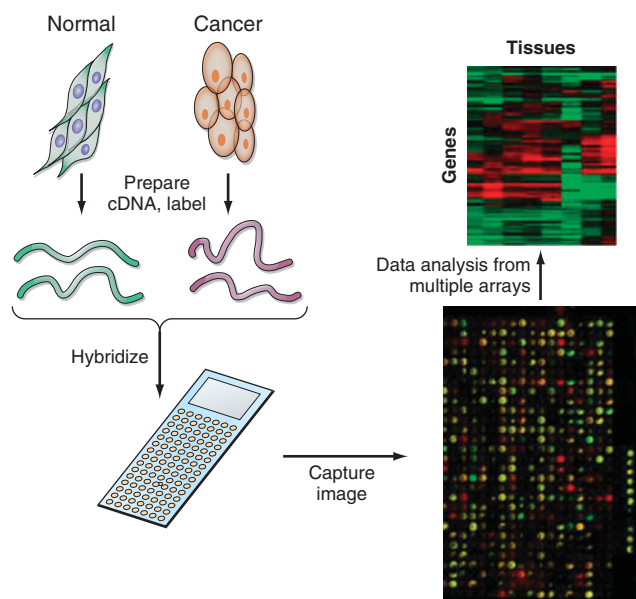
An *epigenetic modification* refers to a change in the genome, heritable by cell progeny, that does not involve a change

in the DNA sequence. The inactivation of the second X chromosome in female cells is an example of an epigenetic mechanism that prevents gene expression from the inactivated chromosome. During embryologic development, regions of chromosomes from one parent are silenced and gene expression proceeds from the chromosome of the other parent. For most genes, expression occurs from both alleles or randomly from one allele or the other. The preferential expression of a particular gene exclusively from the allele contributed by one parent is called *parental imprinting* and is thought to be regulated by covalent modifications of chromatin protein and DNA (often methylation) of the silenced allele.

The role of epigenetic control mechanisms in the development of human cancer is unclear. However, a general decrease in the level of DNA methylation has been noted as a common change in cancer. In addition, numerous genes, including some tumor-suppressor genes, appear to become hypermethylated and silenced during tumorigenesis. *VHL* and *p16INK4* are well-studied examples of tumor-suppressor genes that are silenced through methylation in human cancers. Overall, epigenetic mechanisms may be responsible for reprogramming the expression of a large number of genes in cancer and, together with the mutation of specific genes, are likely to be crucial in the development of human malignancies.

### **GENE EXPRESSION AND MUTATIONAL PROFILING IN CANCER**

The tumorigenesis process, driven by alterations in tumor suppressors, oncogenes, and epigenetic regulation, is accompanied by changes in gene expression. The advent of powerful new techniques such as microarrays and serial analysis of gene expression (SAGE) has allowed the study of gene expression in neoplastic cells on a scale never before accomplished. Indeed, it is now possible to identify expression levels of thousands of genes expressed in normal and cancer tissues. **Figure 23–8** shows a typical cDNA array experiment examining gene expression in cancer. This global knowledge of gene expression allows the identification of differentially expressed genes and, in principle, the understanding of the complex molecular circuitry regulating normal and neoplastic behaviors. Such studies have led to molecular profiling of tumors, which has suggested general methods for distinguishing tumors of various biologic behaviors (molecular classification), elucidating pathways relevant to the development of tumors, and identifying molecular targets for the detection and therapy of cancer. The first practical applications of this technology have suggested that global gene expression profiling can provide prognostic information not evident from other clinical or laboratory tests. The National Cancer Institute, in conjunction with the National Center for Biotechnology Information, has



**FIGURE 23-8**

**A cDNA array experiment.** RNA is prepared from cells, reverse transcribed to cDNA, and labeled with fluorescent dyes (typically green for normal cells and red for cancer cells). The fluorescent probes are mixed and hybridized to the cDNA array. Each spot on the array is a cDNA fragment that represents a different gene. The image is then captured with a fluorescence camera; red spots indicate higher expression in tumor compared with reference and green spots represent the opposite. Yellow signals indicate equal expression levels in normal and tumor specimens. After clustering analysis of multiple arrays, the results are typically represented graphically using Treeview software, which shows, for each sample, a color-coded representation of gene expression for every gene on the array.

undertaken the Cancer Genome Anatomy Project (CGAP) (<http://cgap.nci.nih.gov/>) to collect data on gene expression in normal and malignant tissues and make it available on the Internet.

In addition, with the completion of the Human Genome Project and advances in sequencing technologies, large-scale mutational profiling of the cancer genome has become possible. Hundreds of genes from a given pathway (MAPK pathway, for example) or from a gene family can be systematically sequenced in a large number of cancers in order to identify genes that are crucial to human oncogenesis. This approach has been used to identify several novel targets in various cancers. For example, *B-RAF* mutations were identified in a large fraction of melanomas and *PIK3CA* mutations were identified in large fractions of colon, breast, and hepatocellular cancers. Most recently, this approach has been applied to an unbiased set of genes including about

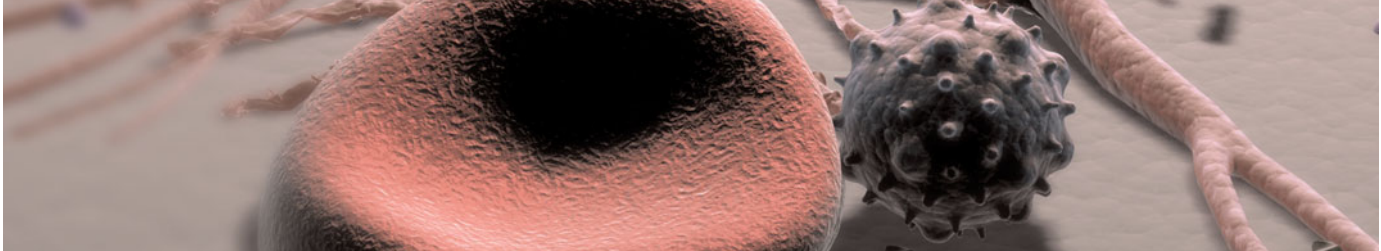
two-thirds of all those known to encode proteins. Hundreds of genes not previously implicated in cancers were shown to be altered in breast and colorectal cancers.

## THE FUTURE

A revolution in cancer genetics has occurred in the past 25 years. Identification of cancer genes has led to a better understanding of the tumorigenesis process and has had important repercussions on all fields of biology. In spite of these spectacular advances, however, there has been little overall improvement in cancer death rates. It is hoped that, as the molecular mechanisms of cancer initiation and development continue to be elucidated, novel therapies based on pathophysiology rather than empiricism will emerge. Time will tell whether these strategies will rely on novel combinations or dosing schedules of conventional drugs or will be based on new approaches such as those involving gene therapy or immunotherapy. In addition, a better understanding of the molecular pathways and genetic alterations in cancer cells may lead to the development of sensitive strategies for early detection of cancer.

## FURTHER READINGS

- GARBER JE, OFFIT K: Hereditary cancer predisposition syndromes. *J Clin Oncol* 23:276, 2005
- GOLUB TR et al: Molecular classification of cancer: Class discovery and class prediction by gene expression monitoring. *Science* 286:531, 1999
- HASTINGS PJ et al: Mechanisms of change in gene copy number. *Nat Rev Genet* 10:551, 2009
- HOLLAND AJ, CLEVELAND DW: Boveri revisited: Chromosomal instability, aneuploidy and tumorigenesis. *Nat Rev Mol Cell Biol* 10:478, 2009
- JALLEPALLI PV, LENGAUER C: Chromosome segregation and cancer: Cutting through the mystery. *Nat Rev Cancer* 1:109, 2001
- LOEB LA: Mutator phenotype may be required for multistage carcinogenesis. *Cancer Res* 51:3075, 1991
- MUNGER K: Disruption of oncogene/tumor suppressor networks during human carcinogenesis. *Cancer Invest* 20:71, 2002
- PARSONS DW et al: Colorectal cancer: Mutations in a signaling pathway. *Nature* 436:792, 2005
- SOTIROPOULOU G et al: Emerging roles of microRNAs as molecular switches in the integrated circuit of the cancer cell. *RNA* 15:1443, 2009
- STRAUSBERG RL et al: In silico analysis of cancer through the Cancer Genome Anatomy Project. *Trends Cell Biol* 11:S66, 2001
- TIMP W et al: A new link between epigenetic progenitor lesions in cancer and the dynamics of signal transduction. *Cell Cycle* 8:383, 2009
- VOGELSTEIN B, KINZLER KW: The multistep nature of cancer. *Trends Genet* 9:138, 1993
- WILLIAMS BR, AMON A: Aneuploidy: Cancer's fatal flaw? *Cancer Res* 69:5289, 2009



## CHAPTER 24

# CANCER CELL BIOLOGY AND ANGIOGENESIS

Robert G. Fenton ■ Dan L. Longo

■ Cancer Cell Biology . . . . .	294	■ Apoptosis . . . . .	305
Therapeutic Approaches to Cell Cycle		■ Metastasis: Determining Risk and Developing	
Abnormalities in Cancer . . . . .	295	Therapeutic Strategies . . . . .	307
Telomerase . . . . .	297	■ New Concepts in the Development of Cancer Therapeutics . . . . .	308
Signal Transduction Pathways as Therapeutic		Cancer Stem Cells . . . . .	308
Targets in Cancer Cells . . . . .	297	Oncogene Addiction and Synthetic Lethality . . . . .	309
Targeting BCR-ABL with Imatinib: Proof of Principle . . . . .	297	■ Tumor Angiogenesis . . . . .	310
Targeting Other Receptor Tyrosine Kinases . . . . .	300	Mechanisms of Tumor Vessel Formation . . . . .	310
■ Alterations in Gene Transcription in Cancer Cells:		Antiangiogenic Therapy . . . . .	314
Role of Epigenetic Changes . . . . .	302	■ Further Readings . . . . .	317

Two characteristic features define a cancer: unregulated cell growth and tissue invasion/metastasis. Unregulated cell growth without invasion is a feature of *benign neoplasms*, or new growths. Cancer is a synonym for *malignant neoplasm*. Cancers of epithelial tissues are called *carcinomas*; cancers of nonepithelial (mesenchymal) tissues are called *sarcomas*. Cancers arising from hematopoietic or lymphoid cells are called *leukemias* or *lymphomas*.

Cancer is a genetic disease. The malignant phenotype often requires mutations in several different genes that regulate cell proliferation, survival, DNA repair, motility, invasion, and angiogenesis (Table 24-1). Cancer-causing mutations often activate signal transduction pathways leading to aberrant cell proliferation and perturbations of tissue-specific differentiation programs. The normal cell has protective mechanisms that lead to the repair of DNA damage that occurs during DNA synthesis and mitosis and in response to environmental mutagens; these repair pathways are often abnormal in cancer cells. When a normal cell has sustained too much damage to repair, the cell activates a suicide pathway to prevent damage to the organ. These cell death pathways are also commonly altered in cancer cells, leading to the survival of damaged cells that would normally die. Cancer cells often exist under conditions of low oxygen tension (hypoxia) and nutrient deprivation, and selective pressure leads to the outgrowth of neoplastic variants that can survive under these conditions through the

upregulation of a series of hypoxia-inducible genes (see later). The acquisition of novel phenotypic characteristics includes those that facilitate invasion and metastasis, such as the ability to break through basement membranes, migrate through the extracellular matrix and into the vascular compartment, and generate new blood vessels to support colonization in remote sites. The accumulation of genetic lesions may lead through an identifiable progression of altered phenotypes as is noted in colon cancer: hyperplasia → adenoma → dysplasia → carcinoma in situ → invasive carcinoma. Premalignant changes have also been identified in prostate, breast, and pancreatic cancers.

### CANCER CELL BIOLOGY

The treatment of most human cancers with conventional cytoreductive agents has been unsuccessful due to the Gompertzian-like growth kinetics of solid tumors (i.e., tumor growth is exponential in small tumors, with increasing doubling times as tumors expand; because conventional chemotherapeutic agents target proliferating cells, noncycling cells in large tumors are relatively resistant). Genetic instability is inherent in most cancer cells and predisposes to the development of intrinsic and acquired drug resistance. Thus, although tumors arise from a single cell (i.e., they are clonal), large tumors become very heterogeneous with multiple related subclones, some

TABLE 24-1

**PHENOTYPIC CHARACTERISTICS OF MALIGNANT CELLS**

**Deregulated cell proliferation:** Loss of negative regulators (suppressor oncogenes, i.e., Rb, p53), and increased positive regulators (oncogenes, i.e., *Ras*, *Myc*). Leads to aberrant cell cycle control and includes loss of normal checkpoint responses.

**Failure to differentiate:** Arrest at a stage prior to terminal differentiation. May retain stem cell properties. (Frequently observed in leukemias due to transcriptional repression of developmental programs by the gene products of chromosomal translocations.)

**Loss of normal apoptosis pathways:** Inactivation of p53, increases in Bcl-2 family members. This defect enhances the survival of cells with oncogenic mutations and genetic instability and allows clonal expansion and diversification within the tumor without activation of physiologic cell death pathways.

**Genetic instability:** Defects in DNA repair pathways leading to either single or oligo-nucleotide mutations (as in microsatellite instability, MIN) or more commonly chromosomal instability (CIN) leading to aneuploidy. Caused by loss of function of p53, BRCA1/2, mismatch repair genes, and others.

**Loss of replicative senescence:** Normal cells stop dividing after 25–50 population doublings. Arrest is mediated by the Rb, p16<sup>INK4a</sup>, and p53 pathways. Further replication leads to telomere loss, with crisis. Surviving cells often harbor gross chromosomal abnormalities.

**Increased angiogenesis:** Due to increased gene expression of proangiogenic factors (VEGF, FGF, IL-8) by tumor or stromal cells, or loss of negative regulators (endostatin, tumstatin, thrombospondin).

**Invasion:** Loss of cell-cell contacts (gap junctions, cadherins) and increased production of matrix metalloproteinases (MMPs). Often takes the form of epithelial-to-mesenchymal transition (EMT) with anchored epithelial cells becoming more like motile fibroblasts.

**Metastasis:** Spread of tumor cells to lymph nodes or distant tissue sites. Limited by the ability of tumor cells to survive in a foreign environment.

**Evasion of the immune system:** Downregulation of MHC class I and II molecules; induction of T cell tolerance; inhibition of normal dendritic cell and/or T cell function; antigenic loss variants and clonal heterogeneity.

**Note:** VEGF, vascular endothelial growth factor; FGF, fibroblast growth factor; IL, interleukin.

of which will be resistant to specific therapies, leading to the selection of progressively more resistant tumors as treatment progresses. Because a 1-cm tumor often contains  $10^9$  cells, and patients typically present to their physicians with  $10^{10}$ – $10^{11}$  tumor cells, the obstacle to curative treatment becomes more understandable. Rationally designed, target-based therapeutic agents, directed against the specific molecular derangements that distinguish malignant from nonmalignant cells, have become possible with

advances in the understanding of oncogene and tumor-suppressor pathways. This chapter describes the convergence of scientific, pharmacologic, and medical knowledge that has led to the targeted therapy of cancer.

**THERAPEUTIC APPROACHES TO CELL CYCLE ABNORMALITIES IN CANCER**

The mechanism of cell division is substantially the same in all dividing cells and has been conserved throughout evolution. The process assures that the cell accurately duplicates its contents, especially its chromosomes. The cell cycle is divided into four phases. During M-phase, the replicated chromosomes are separated and packaged into two new nuclei by mitosis and the cytoplasm is divided between the two daughter cells by cytokinesis. The other three phases of the cell cycle are called *interphase*: G<sub>1</sub> (gap 1), during which the cell determines its readiness to commit to DNA synthesis; S (DNA synthesis), during which the genetic material is replicated and no re-replication is permitted; and G<sub>2</sub> (gap 2), during which the fidelity of DNA replication is assessed and errors are corrected.

Deregulation of the molecular mechanisms controlling cell cycle progression is a hallmark of cancer. Progression from one phase of the cell cycle to the next is controlled by the orderly activation of cyclin-dependent kinases (CDKs) that are regulated by signaling events that couple a cell's physiologic response to its extracellular milieu. In normal cells, specific molecular signals, called *checkpoints*, prevent progression into the next phase of the cell cycle until all requisite physiologic processes are complete. Cancer cells often have defective cell cycle checkpoints. The transition through G<sub>1</sub> into S-phase is a critical regulator of cell proliferation, and the phosphorylation state of the retinoblastoma tumor-suppressor protein (pRB) at the restriction point in late G<sub>1</sub> determines whether a cell will enter S-phase. The complex of CDK4 or CDK6 with D-type cyclins forms a G<sub>1</sub>-specific kinase whose activity is regulated by growth factors, nutrients, and cell-cell and cell-matrix interactions. Subsequent formation of an active CDK2/cyclin E complex results in full phosphorylation of pRB, relieving its inhibitory effects on the S-phase-regulating transcription factor E2F/DP1, and permitting the activation of genes required for S-phase (such as dihydrofolate reductase, thymidine kinase, ribonucleotide reductase, and DNA polymerase). The activity of CDK/cyclin complexes can be blocked by CDK-inhibitors including p21<sup>Cip1/Waf1</sup>, p16<sup>INK4a</sup>, and p27<sup>Kip1</sup>, which block S-phase progression by preventing the phosphorylation of pRB.

Genetic lesions that render the retinoblastoma pathway nonfunctional are thought to occur in all human cancers. Loss of function of pRB as guardian of the G<sub>1</sub> restriction point enables cancer cells to enter a mitotic cycle without the normal input from external signals.



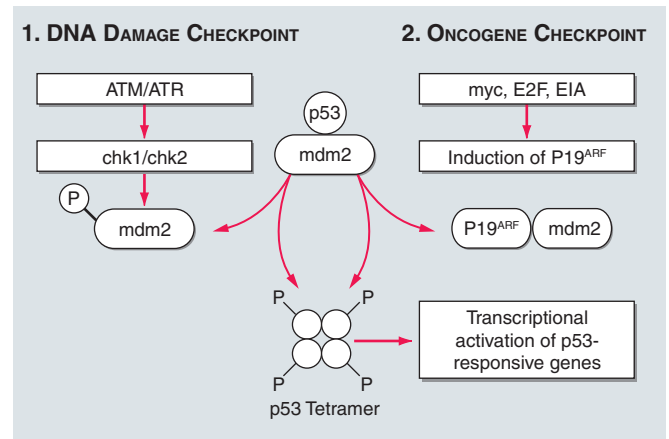
296 Current therapeutic efforts to reverse the derangements of the retinoblastoma pathway have taken two main approaches. All kinases require the binding of ATP (and substrate) to the enzyme active site, followed by transfer of the  $\gamma$ -phosphate to serine, threonine, or tyrosine residues of the substrate. Flavopiridol was the first relatively selective CDK inhibitor identified, with  $K_i$  or  $IC_{50}$ s in the 40- to 400-nM range. Although flavopiridol was initially thought to prevent tumor cell proliferation by inhibition of cell cycle CDKs, it is now clear that regulation of cellular transcription elongation by the CDK7/cyclin H and CDK9/cyclin T1 complexes may be the critical target of flavopiridol. Phase II clinical trials of flavopiridol are in progress; responses have been reported in chronic lymphocytic leukemia after a dosing schedule was defined to optimize the pharmacokinetics of the drug. Laboratory efforts are focused on the development of novel classes of CDK inhibitors capable of specifically targeting individual CDK/cyclin complexes. A second therapeutic endeavor to regain control of pRB function involves reversing the epigenetic silencing of p16<sup>Ink4a</sup> gene and is discussed later.

p53, the “guardian of the genome,” is a sequence-specific transcription factor whose activity is regulated through tight control of p53 protein levels. Normally, levels of p53 are kept low by its association with the mdm2 oncogene product, which binds p53 and shuttles it out of the nucleus for proteolytic degradation. p53 levels are regulated by two checkpoint pathways that are activated in response to DNA damage or oncogene-induced cell proliferation (Fig. 24-1). The loss of p53 function abrogates these checkpoints and enables tumor cells to escape cell cycle arrest, senescence, or apoptosis despite accumulation of mutations and aberrant passage through the cell cycle.

Acquired mutation in p53 is the most common genetic alteration found in human cancer (>50%); germline mutation in p53 is the causative genetic lesion of the Li-Fraumeni familial cancer syndrome. In many tumors, one p53 allele on chromosome 17p is deleted and the other is mutated. The mutations often abrogate the DNA binding function of p53 that is required for its transcription factor activity and tumor-suppressor functions, and also result in high intracellular levels of p53 protein. Inactivation of the p53 pathway compromises cell cycle arrest, attenuates apoptosis induced by DNA damage or other stimuli, and predisposes cells to chromosome instability. This genomic instability greatly increases the probability that p53 null cells will acquire additional mutations and become malignant. *In summary, it is likely that all human cancers have genetic alterations that inactivate the Rb and p53 tumor-suppressor pathways.*

Tumors expressing mutant p53 are more resistant to radiation therapy and chemotherapy than tumors with wild-type p53. If the transcriptional functions of the mutant p53 could be reestablished in tumor cells, massive

apoptosis might ensue, whereas normal cells would be protected because they express very low levels of wild-type p53. Investigators have screened chemical libraries for compounds that inhibit tumor cell growth in a mutant p53-dependent manner. One compound entered cells and induced mutant p53 to adopt an active conformation such that p53-dependent transcriptional activation was restored and apoptosis was selectively induced. This compound also had anti-tumor activity in murine xenograft models. Other investigators have identified a low-molecular-weight, cell-permeable compound that



**FIGURE 24-1** Induction of p53 by the DNA damage and oncogene checkpoints. In response to noxious stimuli, p53 and mdm2 are phosphorylated by the ataxia telangiectasia mutated (ATM) and related ATR serine/threonine kinases, as well as the immediate downstream checkpoint kinases, Chk1 and Chk2. This causes dissociation of p53 from mdm2, leading to increased p53 protein levels and transcription of genes leading to cell cycle arrest (p21<sup>Cip1/Waf1</sup>) or apoptosis (e.g., the proapoptotic Bcl-2 family members Noxa and Puma). Inducers of p53 include hypoxia, DNA damage (caused by ultraviolet radiation, gamma irradiation, or chemotherapy), ribonucleotide depletion, and telomere shortening. A second mechanism of p53 induction is activated by oncogenes such as *Myc*, which promote aberrant G<sub>1</sub>/S transition. This pathway is regulated by a second product of the Ink4a locus, p19<sup>ARF</sup>, which is encoded by an alternative reading frame of the same stretch of DNA that codes for p16<sup>Ink4a</sup>. Levels of ARF are upregulated by *Myc* and E2F, and ARF binds to mdm2 and rescues p53 from its inhibitory effect. This *oncogene checkpoint* leads to the death or senescence (an irreversible arrest in G<sub>1</sub> of the cell cycle) of renegade cells that attempt to enter S-phase without appropriate physiologic signals. Senescent cells have been identified in patients whose premalignant lesions harbor activated oncogenes, for instance, dysplastic nevi that encode an activated form of BRAF (see later), demonstrating that induction of senescence is a protective mechanism that operates in humans to prevent the outgrowth of neoplastic cells.

inhibits the apoptotic functions of wild-type p53 found in normal host cells. This compound protected mice from the toxic effects of radiation therapy and chemotherapy, including bone marrow suppression, gastrointestinal dysfunction, and hair loss. Taken together, these approaches provide proof of principle for the pharmacologic manipulation of p53 function (mutant or wild-type) that could greatly enhance therapeutic efficacy while decreasing toxicity.

Knowledge of the molecular events governing cell cycle regulation has led to the development of viruses that replicate selectively in tumor cells with defined genetic lesions. Such “oncolytic” viruses include adenoviruses designed to replicate in tumor cells that lack functional p53 or have defects in the pRB pathway. The former group includes an adenovirus mutant in which the viral p55 protein (which binds and inhibits p53) was deleted; this virus selectively replicates in tumor cells lacking p53 function. This virus has shown efficacy in phase II clinical trials of head and neck tumors, especially when combined with 5-fluorouracil and cisplatin (50% partial or complete response). The complexities of virus-host interactions (i.e., immune response against replicating virus) will require further refinements of this novel technology before the clinical utility of this approach can be fully realized.

## TELOMERASE

DNA polymerase is unable to replicate the tips of chromosomes, resulting in the loss of DNA at the specialized ends of chromosomes (called *telomeres*) with each replication cycle. At birth, human telomeres are 15- to 20-kb pairs long and are composed of tandem repeats of a six-nucleotide sequence (TTAGGG) that associate with specialized telomere-binding proteins to form a T-loop structure that protects the ends of chromosomes from being mistakenly recognized as damaged. The loss of telomeric repeats with each cell division cycle causes gradual telomere shortening, leading to growth arrest (called *replicative senescence*) when one or more critically short telomeres triggers a p53-regulated DNA-damage checkpoint response. Cells can bypass this growth arrest if pRB and p53 are nonfunctional, but cell death ensues when the unprotected ends of chromosomes precipitate chromosome fusions or other catastrophic DNA rearrangements (termed *crisis*). *The ability to bypass telomere-based growth limitations is thought to be a critical step in the evolution of most malignancies.* This occurs by the reactivation of telomerase expression in cancer cells. Telomerase is an enzyme that adds TTAGGG repeats onto the 3' ends of chromosomes. It contains a catalytic subunit with reverse transcriptase activity (hTERT) and an RNA component that provides the template for telomere extension. Most normal somatic cells do not express sufficient telomerase to prevent telomere attrition with each cell division. Exceptions include stem cells (such as

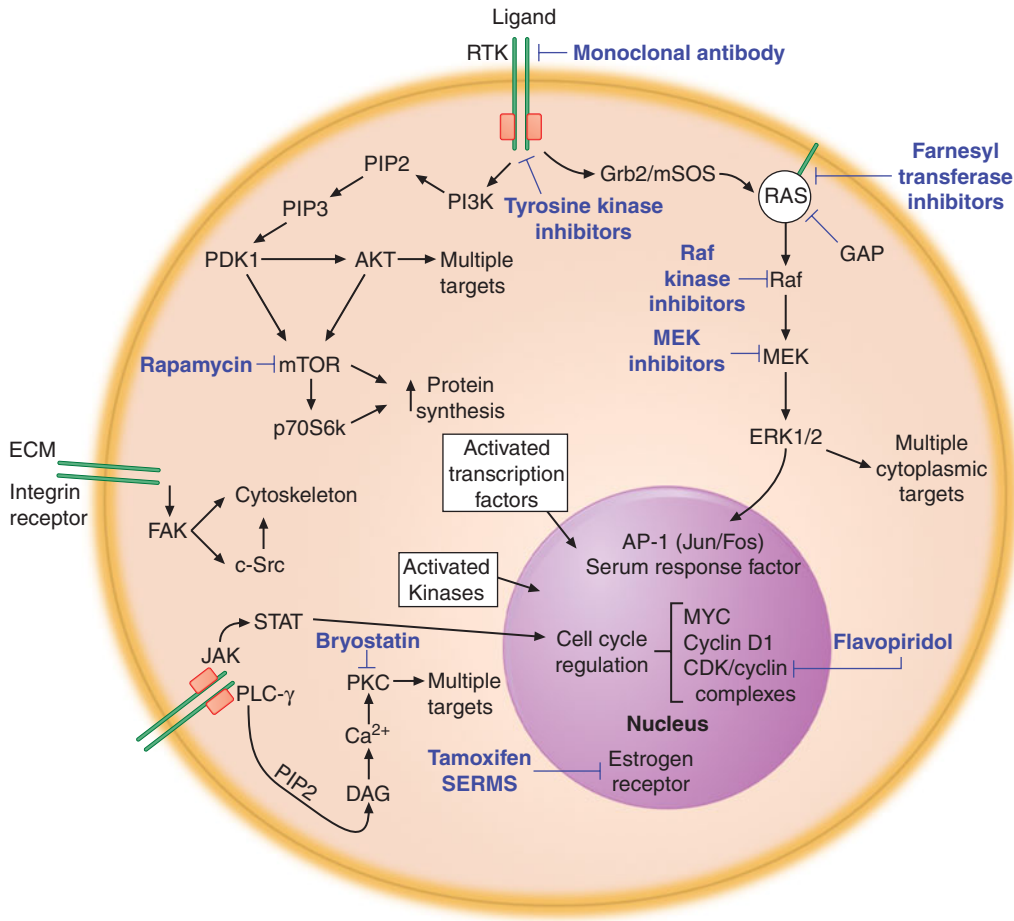
those found in hematopoietic tissues, gut and skin epithelium, and germ cells) that require extensive cell division to maintain tissue homeostasis. More than 90% of human cancers express high levels of telomerase that prevent telomere exhaustion and allow indefinite cell proliferation. In vitro experiments indicate that inhibition of telomerase activity leads to tumor cell apoptosis. Major efforts are underway to develop methods to inhibit telomerase activity in cancer cells. The reverse transcriptase activity of telomerase is a prime target for small-molecule pharmaceuticals. The protein component of telomerase (hTERT) can act as a tumor-associated antigen recognized by antigen-specific cytotoxic T lymphocytes (CTL) that lyse human melanoma, prostate, lung, breast, and colon cancer cells in vitro. Clinical trials of telomerase vaccines are underway.

## SIGNAL TRANSDUCTION PATHWAYS AS THERAPEUTIC TARGETS IN CANCER CELLS

Since the discovery that the *v-src* oncogene has protein tyrosine kinase activity, the central role of tyrosine phosphorylation in cellular responses to growth factors has become apparent. Many tyrosine kinases act at the apex of signaling pathways and are transmembrane proteins (receptor tyrosine kinases, or RTK) or are associated with structures at the plasma membrane (*Src*-, *Janus*-, and *Fak*-family kinases). RTKs are transmembrane glycoproteins that undergo dimerization upon ligand binding, with activation of their cytoplasmic tyrosine kinase domains by proximity-induced transphosphorylation of the activation loop. Tyrosine residues of the receptor or adaptor proteins (such as IRS-1 or Shc) are phosphorylated and act as docking sites for proteins containing SH2 (Src-homology 2) or PTB (phosphotyrosine binding) domains, thus initiating multiple signal transduction pathways (Fig. 24-2). Normally, tyrosine kinase activity is short-lived and reversed by protein tyrosine phosphatases (PTP). However, in many human cancers, tyrosine kinases or components of their downstream pathways are activated by mutation, gene amplification, or chromosomal translocations. Because these pathways regulate proliferation, survival, migration, and angiogenesis, they have been identified as important targets for cancer therapeutics.

## TARGETING BCR-ABL WITH IMATINIB: PROOF OF PRINCIPLE

The protein product of the Philadelphia chromosome occurs in all patients with chronic myeloid leukemia (CML) and in ~30% of patients with adult acute lymphoid leukemia (ALL) and encodes the fusion protein Bcr-Abl. Although the *c-Abl* protooncogene is a nuclear protein whose kinase activity is tightly regulated as a part of the DNA damage response pathway (and actually



**FIGURE 24-2**

**Therapeutic targeting of signal transduction pathways in cancer cells.**

Three major signal transduction pathways are activated by receptor tyrosine kinases (RTK). 1. The proto-oncogene Ras is activated by the Grb2/mSOS guanine nucleotide exchange factor, which induces an association with Raf and activation of downstream kinases (MEK and ERK1/2). 2. Activated PI3K phosphorylates the membrane lipid PIP<sub>2</sub> to generate PIP<sub>3</sub>, which acts as a membrane-docking site for a number of cellular proteins including the serine/threonine kinases PDK1 and Akt. PDK1 has numerous cellular targets including Akt and mTOR. Akt phosphorylates target proteins that promote resistance to apoptosis and enhance cell cycle progression while mTOR and its target p70S6k upregulate protein synthesis to potentiate cell growth. 3. Activation of PLC- $\gamma$  leads to the formation of diacylglycerol (DAG) and increased intracellular calcium, with activation of multiple isoforms of PKC and other enzymes regulated by the calcium/calmodulin system. Other important signaling pathways involve non-RTKs that are activated by

cytokine or integrin receptors. Janus kinases (JAK) phosphorylate STAT (signal transducer and activator of transcription) transcription factors, which translocate to the nucleus and activate target genes. Integrin receptors mediate cellular interactions with the extracellular matrix (ECM), inducing activation of FAK (focal adhesion kinase) and c-Src, which activate multiple downstream pathways, including modulation of the cell cytoskeleton. Many activated kinases and transcription factors migrate into the nucleus where they regulate gene transcription, thus completing the path from extracellular signals, such as growth factors, to a change in cell phenotype, such as induction of differentiation or cell proliferation. The nuclear targets of these processes include transcription factors (e.g., Myc, AP-1, and serum response factor) and the cell cycle machinery (CDKs and cyclins). Inhibitors of many of these pathways have been developed for the treatment of human cancers. Examples of inhibitors that are currently being evaluated in clinical trials are shown in purple.

induces growth arrest), the Bcr-Abl fusion protein is largely cytoplasmic with a constitutively activated tyrosine kinase domain. The deregulated tyrosine kinase activity of Bcr-Abl is required for its transforming activity. The Abl tyrosine kinase inhibitor, imatinib mesylate (Gleevec), has validated the concept of a molecularly targeted approach to cancer treatment.

Imatinib is a low-molecular-weight competitive inhibitor of the ATP binding site of Bcr-Abl, c-Abl, platelet-derived growth factor receptor (PDGFR), and c-Kit; hence it is not absolutely specific for the Bcr-Abl oncogene product (Table 24-2). Clinical studies have demonstrated remarkable activity of this agent in CML. In phase II studies of 532 chronic phase CML patients in

TABLE 24-2

### FDA-APPROVED MOLECULARLY TARGETED AGENTS FOR THE TREATMENT OF CANCER

DRUG	MOLECULAR TARGET	DISEASE	MECHANISM OF ACTION
All-trans retinoic acid (ATRA)	PML-RAR $\alpha$ oncogene	Acute promyelocytic leukemia M3 AML; t(15;17)	Inhibits transcriptional repression by the PML-RAR $\alpha$
Imatinib (Gleevec)	Bcr-Abl, c-Abl, c-Kit, PDGFR- $\alpha/\beta$ ,	Chronic myelogenous leukemia; GIST	Blocks ATP binding to tyrosine kinase active site.
Sunitinib (Sutent)	c-Kit, VEGFR-2, PDGFR- $\beta$ , Flt-3	GIST; renal cell cancer	Inhibits activated c-Kit and PDGFR in GIST; inhibits VEGFR in RCC
Sorafenib (Nexavar)	RAF, VEGFR-2, PDGFR- $\alpha/\beta$ , Flt-3, c-Kit	RCC; may have activity in melanoma when combined with chemotherapy	Targets VEGFR pathways in RCC. Possible activity against BRAF in melanoma, colon cancer, and others.
Erlotinib (Tarceva)	EGFR	Non-small cell lung cancer; pancreatic cancer	Competitive inhibitor of the ATP binding site of the EGFR.
Gefitinib (Iressa)	EGFR	Non-small cell lung cancer	Inhibitor of EGFR tyrosine kinase.
Bortezomib (Velcade)	Proteasome	Multiple myeloma	Inhibits proteolytic degradation of multiple cellular proteins.
<b>Monoclonal Antibodies</b>			
Trastuzumab (Herceptin)	HER2/neu (ERBB2)	Breast cancer	Binds HER2 on tumor cell surface and induces receptor internalization.
Cetuximab (Erbix)	EGFR	Colon cancer, squamous cell carcinoma of the head and neck	Binds extracellular domain of EGFR and blocks binding of EGF and TGF- $\alpha$ ; induces receptor internalization. Potentiates the efficacy chemotherapy and radiotherapy.
Panitumumab (Vectibix)	EGFR	Colon cancer	Like cetuximab; likely to be very similar in clinical activity
Rituximab (Rituxan)	CD20	B cell lymphomas and leukemias that express CD20	Multiple potential mechanisms including direct induction of tumor cell apoptosis and immune mechanisms.
Alemtuzumab (Campath)	CD52	Chronic lymphocytic leukemia and CD52-expressing lymphoid tumors	Immune mechanisms
Bevacizumab (Avastin)	VEGF	Colon, lung, breast cancers; data pending in other tumors	Inhibits angiogenesis by high-affinity binding to VEGF.

**Note:** PML-RAR $\alpha$ , promyelocytic leukemia-retinoic acid receptor-alpha; AML, acute myeloid leukemia; t(15;17), translocation between chromosomes 15 and 17; VEGFR, vascular endothelial growth factor receptor; PDGFR, platelet-derived growth factor receptor; Flt-3, fms-like tyrosine kinase-3; GIST, gastrointestinal stromal tumor; RCC, renal cell cancer; EGFR, epidermal growth factor receptor; TGF- $\alpha$ , transforming growth factor alpha.

whom interferon treatment had failed, 95% obtained a hematologic complete response, with only 9% relapse after a median follow-up of 18 months. With longer follow-up, 75% of patients treated with imatinib in chronic phase remain in remission after nearly 4 years. Imatinib was also active in CML blast crisis with a 52% response rate, although the responses were short-lived (78% relapse within 1 year). Relapse during treatment with imatinib was associated with reactivation of the tyrosine kinase either by amplification of the *Bcr-Abl* locus leading to

increased levels of Bcr-Abl protein or, more commonly, by point mutations within the Bcr-Abl kinase domain that decreased imatinib binding without loss of Bcr-Abl kinase activity. These data constitute genetic proof that the target of imatinib is the Bcr-Abl tyrosine kinase, and that Bcr-Abl kinase activity is still required by imatinib-resistant cells. Two drugs have been developed (dasatinib and nilotinib) that are potent inhibitors against most imatinib-resistant mutants; these compounds have demonstrated significant activity in patients with imatinib-resistant CML.

Imatinib has also demonstrated targeted activity in other diseases, including gastrointestinal stromal tumors (GIST), rare mesenchymal tumors of the GI tract (stomach and small intestine). The pathogenic molecular event for most patients with this disease is mutation of the protooncogene *c-Kit*, leading to the constitutive activation of this receptor tyrosine kinase without the binding of its physiologic ligand, stem cell factor. About 10% of GISTs encode activating mutations of the PDGFR $\alpha$  instead of *c-Kit*. GISTs are thought to arise from or share a common stem cell with the interstitial cells of Cajal, which give rise to the myenteric plexus of the GI tract. Imatinib, which inhibits the *c-Kit* kinase domain, has demonstrated significant activity (>50% partial responses usually lasting 1–2 years) in this chemotherapy-refractory tumor. Resistance to imatinib develops due to secondary mutations in *c-Kit*, and many of these tumors are susceptible to treatment with the multitargeted TK inhibitor sunitinib that has activity against *c-Kit* as well as the PDGF and vascular endothelial growth factor (VEGF) receptors. Sunitinib is approved by the U.S. Food and Drug Administration for treatment of patients with imatinib-resistant GIST or who are intolerant of imatinib (Table 24-2). Interestingly, tumors with mutations in exon 11 of *c-Kit*'s juxtamembrane region are particularly sensitive to imatinib, whereas those with exon 9 mutations (extracellular domain) respond better to sunitinib than imatinib. In the future, primary therapy for GIST may be determined by the specific molecular defect in *c-Kit*. Patients with chronic myelomonocytic leukemia (CMML, a myeloproliferative disorder) often harbor a Tel-PDGFR translocation that results in constitutive activation of the PDGFR kinase domain exclusively in the leukemic cells. Imatinib inhibits this kinase and has demonstrated significant activity in this disease. *These examples extend the proof of principle that targeting of signaling pathways in cancer cells can be highly efficacious with minimal toxicity, even when the drug does not have absolute target specificity.* Imatinib has become the paradigm of targeted drug development in other diseases.

## TARGETING OTHER RECEPTOR TYROSINE KINASES

Epidermal growth factor receptor (EGFR) mutations define a novel subset of lung cancers. Clinical studies of two high-affinity competitive inhibitors of the ATP binding site in the EGFR kinase domain, gefitinib and erlotinib, have provided important insights into the pathogenesis of different subsets of patients with non-small cell lung cancer (NSCLC). Phase III studies led to FDA approval after ~10–20% of advanced-stage patients treated with single-agent gefitinib or erlotinib had objective tumor responses. Responders tended to have adenocarcinoma or bronchoalveolar histology (not squamous or large cell), and were never-smokers, women,

and of eastern Asian origin. DNA sequence analysis of the *EGFR* gene isolated from the tumors of responding patients (mostly nonsmokers) demonstrated that most had acquired mutations of the kinase domain that led to increased tyrosine kinase activity. Frequently, patients with mutated alleles also had evidence of *EGFR* gene amplification by fluorescence in situ hybridization (FISH). These tumors exhibited euploid chromosome content, in contrast to tumors from smokers, which were most often aneuploid and harbored mutations in the *K-Ras* oncogene. In fact, mutated *K-Ras*, which occurs to the exclusion of *EGFR* mutation, appears to define a subset of patients with low likelihood of response to *EGFR* inhibitors. Thus the model has been proposed that the pathogenesis of NSCLC in never-smokers occurs through a novel pathway that is dependent on activated *EGFR*, and that tumors are *addicted* to this oncogene, rendering them highly susceptible to its inhibition (see Fig. 24-7). No *EGFR* kinase domain mutations have yet been found in tumors other than NSCLC. *Thus these studies define a novel oncogenic pathway for an important human cancer, and they provide a mechanism to identify subsets of patients likely to respond to the targeted therapy.* The wild-type *EGFR* is expressed by many other human cancers, and in colon cancer and head and neck cancers, targeting of the *EGFR* with a monoclonal antibody (cetuximab) has demonstrated improved survival when combined with chemotherapy or radiation therapy.

*HER2/neu* is a target in human breast cancer. The gene encoding *HER2/neu*, a member of the *EGFR* family, is amplified in ~20% of breast cancers. Tumors that overexpress *HER2/neu* are less responsive to chemotherapy, and patients with these tumors have a reduced survival compared with patients with normal levels of *HER2/neu*. Trastuzumab (Herceptin) is a humanized monoclonal antibody that binds *HER2/neu* on the surface of tumor cells and induces internalization of the receptor, thereby reducing the level of surface expression. This leads to inhibition of cell cycle progression and renders cancer cells more susceptible to the induction of apoptosis. Phase III clinical trials demonstrated that combining trastuzumab with chemotherapy significantly improved response rates and overall survival in patients with metastatic *HER2*-positive disease, leading to FDA approval. In addition, five randomized trials demonstrated that the addition of trastuzumab to chemotherapy in the adjuvant setting for patients with *HER2*-positive disease reduces the risk of recurrence by nearly 50%. These studies emphasize the critical pathogenic role of *HER2*-overexpression in a subset of breast cancer patients.

The PDGFR and its ligand, platelet-derived growth factor (PDGF), are overexpressed in many glioblastomas and in subsets of melanoma, ovarian, pancreatic, gastric, lung, and prostate cancers. Overexpression of the

hepatocyte growth factor receptor c-MET has been observed in many human cancers and correlates with a poor prognosis, perhaps due to its role in invasion and metastasis. Small-molecule inhibitors of these RTKs are being developed for clinical use. As described later, the vascular endothelial growth factor receptor (VEGFR), TIE, and EPH RTK families have been identified as important therapeutic targets for inhibition of angiogenesis.

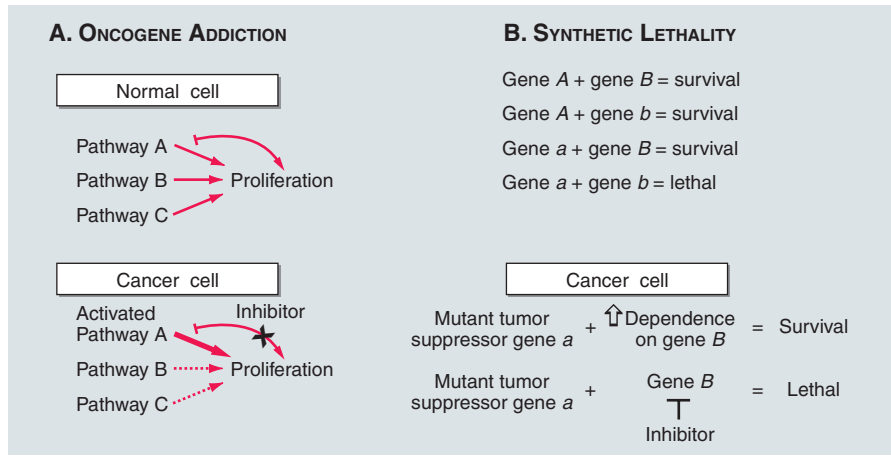
### Signaling Pathways Downstream of RTKs: Ras and PI3K

Several oncogene and tumor-suppressor gene products are components of signal transduction pathways that emanate from RTK activation (Fig. 24-2). The most extensively studied are the Ras/mitogen-activated protein (MAP) kinase pathway and the phosphatidylinositol-3-kinase (PI3K) pathway, both of which regulate multiple processes in cancer cells, including cell cycle progression, resistance to apoptotic signals, angiogenesis, and cell motility. The development of inhibitors of these pathways is an important avenue of anticancer drug development.

Mutation of the *Ras* protooncogene occurs in 20% of human cancers and results in loss of the response of oncogenic Ras to GTPase-activating proteins (GAPs). The constitutively activated GTP-bound Ras activates downstream effectors including the MAP kinase and PI3K/Akt pathways. Cancers of the pancreas, colon, and lung and AML harbor frequent *Ras* mutations, with the K-*Ras* allele affected more commonly (85%) than N-*Ras* (15%); H-*Ras* mutations are uncommon in human cancers. In addition, *Ras* activity in tumor cells can be increased by other mechanisms, including upregulation of RTK activity and mutation of GAP proteins (e.g., *NF1* mutations in type I neurofibromatosis). Ras proteins localize to the inner plasma membrane and require posttranslational modifications, including addition of a farnesyl lipid moiety to the cysteine residue of the carboxy-terminal CAAX-box motif. Inhibition of RAS farnesylation by rationally designed farnesyltransferase inhibitors (FTIs) demonstrated encouraging efficacy in preclinical models, most of which utilized oncogenic forms of H-Ras. Despite this, clinical trials of FTIs in patients whose tumors harbor *Ras* mutations have been disappointing, although some activity has been seen in AML. Upon further study, it appears that in the presence of FTIs, lipid modification of the K- and N-Ras proteins occurs by addition of a distinct lipid (geranylgeranyl) through the action of geranylgeranyl transferase-I (GGT-I), which results in restoration of Ras function. Thus, although FTIs are likely to have antitumor activity in select human cancers, their mechanism of action appears to occur by inhibition of farnesylation of proteins other than Ras, perhaps RhoB or Rheb (an activator of mTOR). Oncologists anxiously await the development of bona fide Ras-targeted therapeutics.

Effector pathways downstream of Ras are also targets of anticancer drug efforts. Activation of the Raf serine/threonine kinase is induced by binding to Ras and leads to activation of the MAP kinase pathway (Fig. 24-2). Two-thirds of melanomas and 10% of colon cancers harbor activating mutations in the *BRAF* oncogene, leading to constitutive activation of the downstream MAP/ERK kinase (MEK) and extracellular signal-regulated kinases (ERK1/2). This results in the phosphorylation of ERK's cytoplasmic and nuclear targets and alters the pattern of normal cellular gene expression. Inhibitors of Raf kinases (e.g., sorafenib) have entered clinical trials; their activity against tumors expressing mutant *BRAF* have been disappointing as single agents, but they appear to increase the activity of chemotherapy in some cases. Sorafenib also has significant activity against VEGFRs, and this may account for its clinical activity observed in highly vascular renal cell cancers (see later). Cells harboring mutant *BRAF* are highly sensitive to MEK inhibition, providing another example of “oncogene addiction” (Fig. 24-3).

PI3K is a heterodimeric lipid kinase that catalyses the conversion of phosphatidylinositol bisphosphate (PIP<sub>2</sub>) to phosphatidylinositol trisphosphate (PIP<sub>3</sub>), which acts as a plasma membrane docking site for proteins that contain a pleckstrin homology (PH) domain. These include the serine/threonine kinases Akt and PDK1 that are key downstream effectors of PI3K action (Fig. 24-2). The PI3K pathway is activated in 30–40% of human cancers and is thought to play a critical role in tumor cell survival, proliferation, growth, and glucose utilization. Amplification or activating point mutation of the gene encoding the catalytic subunit of PI3K (p110) is observed in 20–30% of breast, colon, brain, gastric, and ovarian cancers, and amplification of the *Akt2* gene occurs in breast, ovarian, and pancreatic cancers. The tumor suppressor PTEN (phosphatase with tensin homology), a lipid phosphatase that acts as an off signal for PI3K by dephosphorylating PIP<sub>3</sub>, is mutated in many human cancers, leading to unchecked activity of the PI3K pathway. Akt promotes cell survival by activation of the transcription factor nuclear factor of  $\kappa$ B (NF $\kappa$ B); it also enhances cell cycle progression by inhibition of glycogen synthetase kinase 3 $\beta$  (GSK3 $\beta$ ) and FOXO transcription factors, thus preventing inactivation of Myc,  $\beta$ -catenin, cyclin D1, and cyclin E, and blocking upregulation of p27<sup>Kip1</sup> and Bim (an apoptosis-inducing protein). Furthermore, the growth of cancer cells requires the activation of two downstream kinases, mammalian target of rapamycin (mTOR) and p70S6K, whose activities promote the translation of cellular mRNAs. Targeted interruption of the PI3K pathway is being attempted at multiple levels. Inhibitors of mTOR, including rapamycin and its more soluble ester derivative temsirolimus (tem), selectively kill human tumor cell lines with PTEN mutations and upregulated PI3K pathway activity. Early clinical data indicate that tem has activity in

**FIGURE 24-3**

**Oncogene addiction and synthetic lethality: keys to discovery of new anticancer drugs.** Panel **A**. Normal cells receive environmental signals that activate signaling pathways (pathways A, B, and C) that together promote G1 to S phase transition and passage through the cell cycle. Inhibition of one pathway (such as pathway A by a targeted inhibitor) has no significant effect due to redundancy provided by pathways B and C. In cancer cells, oncogenic mutations lead over time to dependency on the activated pathway, with loss of significant input from pathways B and C. The dependency or addiction of the cancer cell to pathway A makes it highly vulnerable to inhibitors that target components of this pathway. Clinically relevant examples include Bcr-Abl (CML), amplified *HER2/neu* (breast cancer), overexpressed or mutated EGF receptors (lung cancer), and mutated *BRAF* (melanoma). Panel **B**. Genes are said to have a synthetic lethal relationship when mutation of either gene alone is tolerated by the cell, but mutation of both genes leads to lethality. Thus, in the example, mutant *gene a* and

*gene b* have a synthetic lethal relationship, implying that the loss of one gene makes the cell dependent on the function of the other gene. In cancer cells, loss of function of a tumor-suppressor gene (wild-type designated *gene A*; mutant designated *gene a*) may render the cancer cells dependent on an alternative pathway of which *gene B* is a component. As shown in the figure, if an inhibitor of *gene B* can be identified, this can cause death of the cancer cell, without harming normal cells (which maintain wild-type function for *gene A*). High-throughput screens can now be performed using isogenic cell line pairs in which one cell line has a defined defect in a tumor-suppressor pathway. Compounds can be identified that selectively kill the mutant cell line; targets of these compounds have a synthetic lethal relationship to the tumor-suppressor pathway, and they are potentially important targets for future therapeutics. Note that this approach allows discovery of drugs that indirectly target deleted tumor-suppressor genes and hence greatly expands the list of physiologically relevant cancer targets.

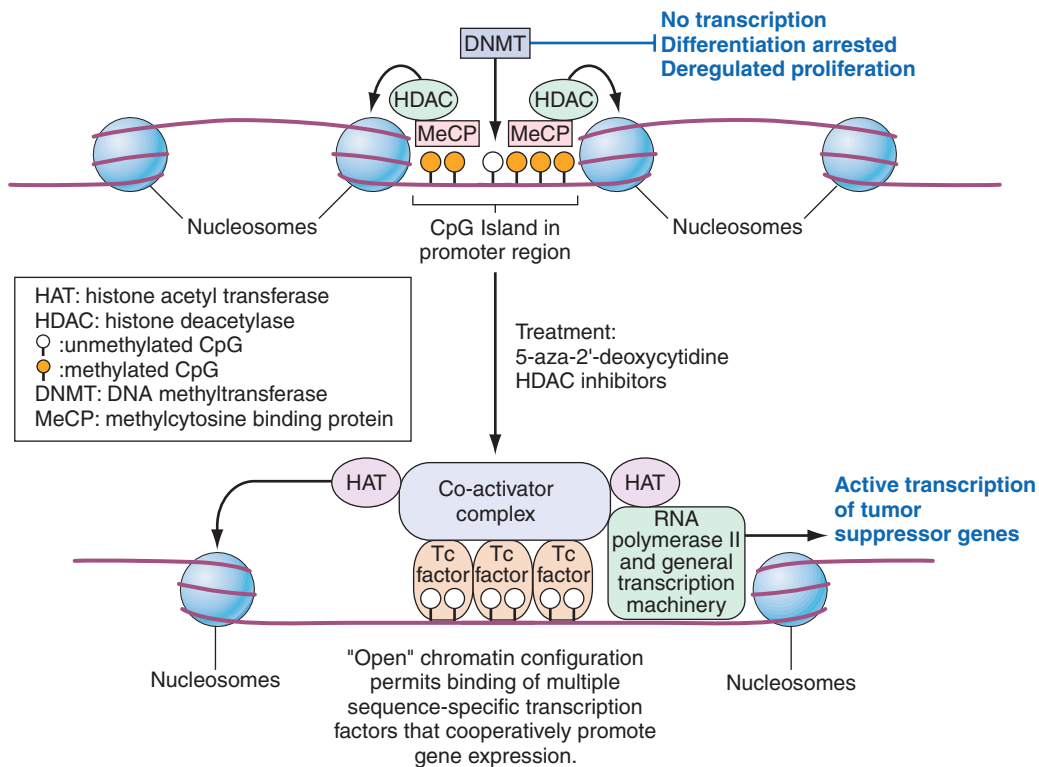
renal cell cancer, perhaps by blocking the translation of the transcription factor hypoxia-inducible factor (HIF)-1 $\alpha$  mRNA, a mediator of cellular responses to hypoxia, which requires mTOR activity for efficient translation.

RTKs activate other signaling pathways. Activation of phospholipase C- $\gamma$ (PLC) results in the hydrolysis of PIP<sub>2</sub> into diacylglycerol (DAG) and IP<sub>3</sub>. DAG together with calcium ion (Ca<sup>2+</sup>) activates protein kinase C (PKC), a family of serine/threonine-specific protein kinases with different activation requirements, subcellular locations, and substrates in different cell types. PKC is the target of tumor-promoting phorbol esters, and its activation can modulate cell proliferation, differentiation, and tumorigenesis. The PKC inhibitor bryostatin 1 has reached phase II clinical trials and thus far has demonstrated only minimal antitumor activity. However, an antisense oligonucleotide directed against PKC and a number of small molecule inhibitors that demonstrate

greater selectivity for PKC isoforms are undergoing clinical evaluation.

### ALTERATIONS IN GENE TRANSCRIPTION IN CANCER CELLS: ROLE OF EPIGENETIC CHANGES

Chromatin structure regulates the hierarchical order of sequential gene transcription that governs differentiation and tissue homeostasis. Disruption of chromatin remodeling leads to aberrant gene expression and can induce proliferation of undifferentiated cells, leading to cancer. *Epigenetics* is defined as changes that alter the pattern of gene expression that persist across at least one cell division but are not caused by changes in the DNA code. Epigenetic changes include alterations of chromatin structure mediated by methylation of cytosine residues in



**FIGURE 24-4**

**Epigenetic regulation of gene expression in cancer cells.**

Tumor-suppressor genes are often epigenetically silenced in cancer cells. In the upper portion, a CpG island within the promoter and enhancer regions of the gene has been methylated, resulting in the recruitment of methyl-cytosine binding proteins (MeCP) and complexes with histone deacetylase (HDAC) activity. Chromatin is in a condensed, nonpermissive conformation that inhibits transcription. Clinical trials are underway utilizing the combination of demethylating agents such as 5-aza-2'-deoxycytidine plus HDAC inhibitors, which

together confer an open, permissive chromatin structure (lower portion). Transcription factors bind to specific DNA sequences in promoter regions and, through protein-protein interactions, recruit coactivator complexes containing histone acetyl transferase (HAT) activity. This enhances transcription initiation by RNA polymerase II and associated general transcription factors. The expression of the tumor-suppressor gene commences, with phenotypic changes that may include growth arrest, differentiation, or apoptosis.

CpG dinucleotides, modification of histones by acetylation or methylation, or changes in higher-order chromosome structure (Fig. 24-4). The transcriptional regulatory regions of active genes often contain a high frequency of CpG dinucleotides (referred to as *CpG islands*), which under normal circumstances remain unmethylated. Expression of these genes is controlled by transient association with repressor or activator proteins that regulate transcriptional activation. However, hypermethylation of promoter regions is a common mechanism by which tumor-suppressor loci are epigenetically silenced in cancer cells. Thus one allele may be inactivated by mutation or deletion (as occurs in loss of heterozygosity) while expression of the other allele is epigenetically silenced. The mechanisms that target suppressor oncogenes for this form of gene silencing are unknown.

Acetylation of the amino terminus of the core histones H3 and H4 induces an open chromatin conformation

that promotes transcription initiation. Histone acetylases are components of coactivator complexes recruited to promoter/enhancer regions by sequence-specific transcription factors during the activation of genes (Fig. 24-4). Histone deacetylases (HDACs; at least 17 are encoded in the human genome) are recruited to genes by transcriptional repressors and prevent the initiation of gene transcription. Methylated cytosine residues in promoter regions become associated with methyl-cytosine-binding proteins that recruit protein complexes with HDAC activity. The balance between permissive and inhibitory chromatin structure is therefore largely determined by the activity of transcription factors in modulating the "histone code" and the methylation status of the genetic regulatory elements of genes.

The pattern of gene transcription is aberrant in all human cancers, and in many cases, epigenetic events are responsible. Unlike genetic events that alter DNA



304 primary structure (e.g., deletions), epigenetic changes are potentially reversible and appear amenable to therapeutic intervention. In many human cancers, including pancreatic cancer and multiple myeloma, the p16<sup>Ink4a</sup> promoter is inactivated by methylation, thus permitting the unchecked activity of CDK4/cyclin D and rendering pRB nonfunctional. In sporadic forms of renal, breast, and colon cancer, the von Hippel-Lindau (*VHL*), breast cancer 1 (*BRCA1*), and serine/threonine kinase 11 (*STK11*) genes, respectively, are epigenetically silenced. Other targeted genes include the p15<sup>Ink4b</sup> CDK inhibitor, glutathione-S-transferase (which detoxifies reactive oxygen species), and the E-cadherin molecule (important for junction formation between epithelial cells). Epigenetic silencing can occur in premalignant lesions and can affect genes involved in DNA repair, thus predisposing to further genetic damage. Examples include MLH1 (mut L homologue) in hereditary non-polyposis colon cancer (HNPCC, also called Lynch's syndrome), which is critical for repair of mismatched bases that occur during DNA synthesis, and O<sup>6</sup>-methylguanine-DNA methyltransferase, which removes alkylated guanine adducts from DNA and is often silenced in colon, lung, and lymphoid tumors.

Many human leukemias have chromosomal translocations that code for novel fusion proteins with enzymatic activities that alter chromatin structure. The PML-RAR fusion protein, generated by the t(15;17) observed in most cases of acute promyelocytic leukemia (APL), binds to promoters containing retinoic acid response elements and recruits HDAC to these promoters, effectively inhibiting gene expression. This arrests differentiation at the promyelocyte stage and promotes tumor cell proliferation and survival. Treatment with pharmacologic doses of all-*trans* retinoic acid (ATRA), the ligand for RAR $\alpha$ , results in the release of HDAC activity and the recruitment of coactivators, which overcomes the differentiation block. This induced differentiation of APL cells has greatly improved treatment of these patients and has provided a treatment paradigm for the reversal of epigenetic changes in cancer. However, for other leukemia-associated fusion proteins, such as AML-ETO and the MLL fusion proteins seen in AML and ALL, no ligand is known. Therefore, efforts are ongoing to determine the structural basis for interactions between translocation fusion proteins and chromatin remodeling proteins, and to use this information to rationally design small molecules that will disrupt specific protein-protein associations. Drugs that block the enzymatic activity of HDAC are being developed. A number of different chemical classes of HDAC inhibitors have demonstrated antitumor activity in clinical studies against cutaneous T cell lymphoma (e.g., Vorinostat) and some solid tumors. HDAC inhibitors may target cancer cells via a number of mechanisms

including upregulation of death receptors (DR4/5, FAS, and their ligands) and p21<sup>Cip1/Waf1</sup>, as well as inhibition of cell cycle checkpoints.

Major therapeutic efforts are also under way to reverse the hypermethylation of CpG islands that characterizes many solid tumors. Drugs that induce DNA demethylation, such as 5-aza-2'-deoxycytidine, can lead to reexpression of silenced genes in cancer cells with restoration of function. However, 5-aza-2'-deoxycytidine has limited aqueous solubility and is myelosuppressive. Other inhibitors of DNA methyltransferases are in development. In ongoing clinical trials, inhibitors of DNA methylation are being combined with HDAC inhibitors. The hope is that by reversing coexisting epigenetic changes, the deregulated patterns of gene transcription in cancer cells will be at least partially reversed.

Aberrant signal transduction pathways activate a number of transcription factors that promote tumor cell proliferation and survival. These include signal transducer and activator of transcription (STAT)-3 and STAT5, NF $\kappa$ B,  $\beta$ -catenin (a component of the APC tumor-suppressor pathway), the heterodimer of c-Jun and Fos known as AP1, and c-Myc. The ability to target these transcription factors therapeutically does not currently exist. However, structural and molecular approaches may make it possible to identify small molecules that would inhibit protein-protein interactions needed for transcription factor dimerization or interaction with coactivator proteins. A small-molecule inhibitor has been developed that blocks the association of Myc with its partner Max, thereby inhibiting Myc-induced transformation. Many transcription factors are activated by phosphorylation, which can be prevented by tyrosine- or serine/threonine kinase inhibitors. The transcription factor NF $\kappa$ B is a heterodimer composed of p65 and p50 subunits that associate with an inhibitor, I $\kappa$ B, in the cell cytoplasm. In response to growth factor or cytokine signaling, a multi-subunit kinase called IKK (I $\kappa$ B-kinase) phosphorylates I $\kappa$ B and directs its degradation by the ubiquitin/proteasome system. NF $\kappa$ B, free of its inhibitor, translocates to the nucleus and activates target genes, many of which promote the survival of tumor cells. Novel drugs called *proteasome inhibitors* block the proteolysis of I $\kappa$ B, thereby preventing NF $\kappa$ B activation. For unexplained reasons, this is selectively toxic to tumor cells. Further studies have indicated that the antitumor effects of proteasome inhibitors are more complicated and involve the inhibition of the degradation of multiple cellular proteins. Proteasome inhibitors [bortezomib (Velcade)] have shown very significant activity in patients with multiple myeloma, including partial and complete remissions. Inhibitors of IKK are also in development, with the hope of more selectively blocking the degradation of I $\kappa$ B, thus "locking" NF $\kappa$ B in an

inhibitory complex and rendering the cancer cell more susceptible to apoptosis-inducing agents.

Estrogen receptors (ERs) and androgen receptors, members of the steroid hormone family of nuclear receptors, are targets of inhibition by drugs used to treat breast and prostate cancers, respectively. Tamoxifen, a partial agonist and antagonist of ER function, can mediate tumor regression in metastatic breast cancer and can prevent disease recurrence in the adjuvant setting, saving thousands of lives each year. Tamoxifen binds to the ER and modulates its transcriptional activity, inhibiting activity in the breast but promoting activity in bone and uterine epithelium. Selective estrogen receptor modulators (SERMs) have been developed with the hope of a more beneficial modulation of ER activity, i.e., antiestrogenic activity in the breast, uterus, and ovary, but estrogenic for bone, brain, and cardiovascular tissues. Aromatase inhibitors, which block the conversion of androgens to estrogens in breast and subcutaneous fat tissues, have demonstrated improved clinical efficacy compared with tamoxifen and are often used as first-line therapy in patients with ER-positive disease (Chap. 34).

## APOPTOSIS

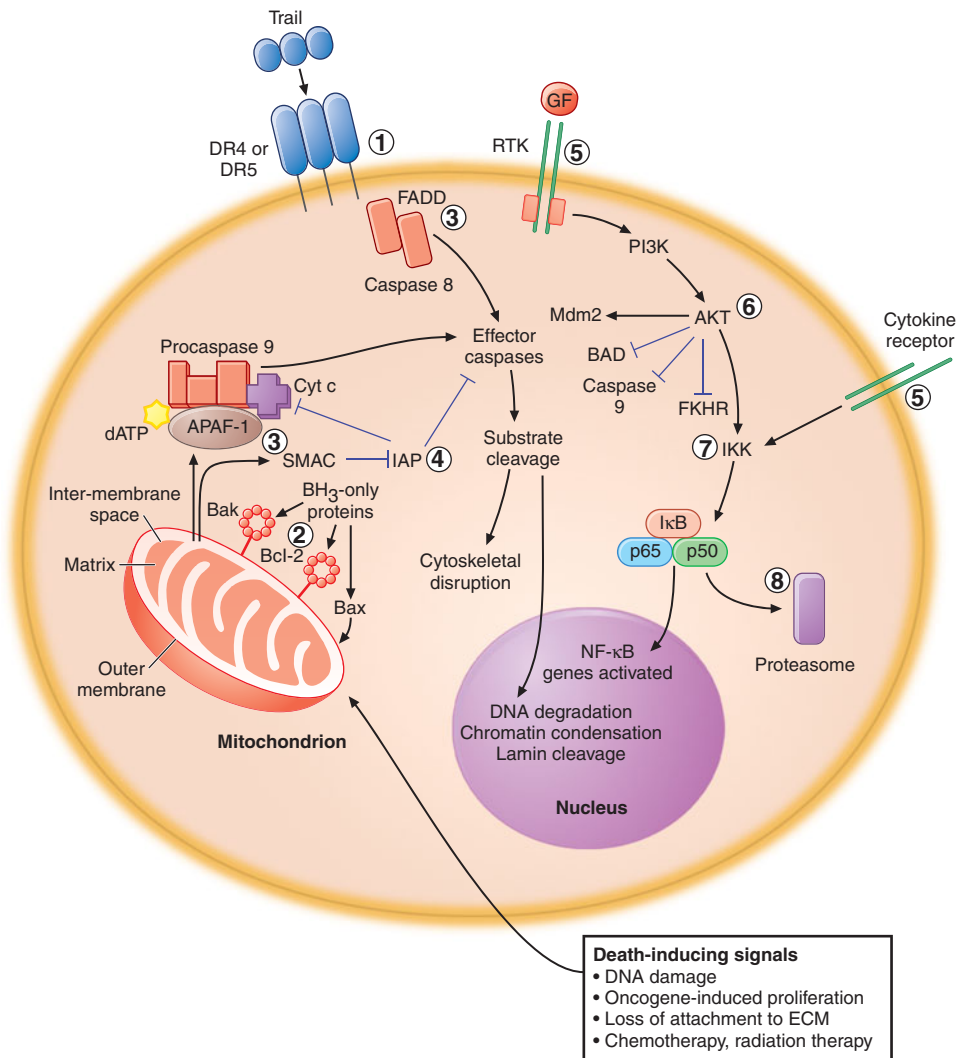
Tissue homeostasis requires a balance between the death of aged, terminally differentiated cells and their renewal by proliferation of committed progenitors. Genetic damage to growth-regulating genes of stem cells could lead to catastrophic results for the host as a whole. However, genetic events causing activation of oncogenes or loss of tumor suppressors, which would be predicted to lead to unregulated cell proliferation, instead activate signal transduction pathways that block aberrant cell proliferation. These pathways can lead to programmed cell death (*apoptosis*) or irreversible growth arrest (*senescence*). Much as a panoply of intra- and extracellular signals impinge on the core cell cycle machinery to regulate cell division, so too these signals are transmitted to a core enzymatic machinery that regulates cell death and survival.

Apoptosis is induced by two main pathways (Fig. 24-5). The extrinsic pathway of apoptosis is activated by cross-linking members of the tumor necrosis factor (TNF) receptor superfamily, such as CD95 (Fas) and death receptors DR4 and DR5, by their receptors, Fas ligand or TRAIL (TNF-related apoptosis-inducing ligand), respectively. This induces the association of FADD (Fas-associated death domain) and procaspase-8 to death domain motifs of the receptors. Caspase-8 is activated and then cleaves and activates effector caspases-3 and -7, which then target cellular constituents (including caspase-activated DNase, cytoskeletal proteins, and a number of regulatory proteins), inducing the morphologic appearance characteristic of apoptosis. The intrinsic pathway of apoptosis is initiated by

the release of cytochrome c and SMAC (second mitochondrial activator of caspases) from the mitochondrial intermembrane space in response to a variety of noxious stimuli, including DNA damage, loss of adherence to the extracellular matrix (ECM), oncogene-induced proliferation, and growth factor deprivation. Upon release into the cytoplasm, cytochrome c associates with dATP, procaspase-9, and the adaptor protein APAF-1, leading to the sequential activation of caspase-9 and effector caspases. SMAC binds to and blocks the function of inhibitor of apoptosis proteins (IAPs), negative regulators of caspase activation.

The release of apoptosis-inducing proteins from the mitochondria is regulated by pro- and antiapoptotic members of the Bcl-2 family. Antiapoptotic members (e.g., Bcl-2, Bcl-XL, and Mcl-1) associate with the mitochondrial outer membrane via their carboxy termini, exposing to the cytoplasm a hydrophobic binding pocket composed of Bcl-2 homology (BH) domains 1, 2, and 3 that is crucial for their activity. Perturbations of normal physiologic processes in specific cellular compartments lead to the activation of BH3-only proapoptotic family members (such as Bad, Bim, Bid, Puma, Noxa, and others) that can alter the conformation of the outer-membrane proteins Bax and Bak, which then oligomerize to form pores in the mitochondrial outer membrane resulting in cytochrome c release. If BH3-only proteins are sequestered by Bcl-2, Bcl-XL, or Mcl-1, pores do not form and apoptosis-inducing proteins are not released from the mitochondrion. The relative levels of expression of antiapoptotic Bcl-2 family members compared to the levels of proapoptotic BH3-only proteins at the mitochondrial membrane determines the activation state of the intrinsic pathway. The mitochondrion must therefore be recognized not only as an organelle with vital roles in intermediary metabolism and oxidative phosphorylation but also as a central regulatory structure of the apoptotic process.

The evolution of tumor cells to a more malignant phenotype requires the acquisition of genetic changes that subvert apoptosis pathways and promote cancer cell survival and resistance to anticancer therapies. However, because of their deranged physiology, cancer cells may be more vulnerable than normal cells to therapeutic interventions that target the apoptosis pathways that cancer cells are very dependent on. For instance, overexpression of Bcl-2 as a result of the t(14;18) translocation contributes to follicular lymphoma. Upregulation of Bcl-2 expression is also observed in prostate, breast, and lung cancers and melanoma. Targeting of antiapoptotic Bcl-2 family members has been accomplished by the identification of several low-molecular-weight compounds that bind to the hydrophobic pockets of either Bcl-2 or Bcl-XL and block their ability to associate with death-inducing

**FIGURE 24-5**

**Therapeutic strategies to overcome aberrant survival pathways in cancer cells.** **1.** The extrinsic pathway of apoptosis can be selectively induced in cancer cells by TRAIL (the ligand for death receptors 4 and 5) or by agonistic monoclonal antibodies. **2.** Inhibition of antiapoptotic Bcl-2 family members with antisense oligonucleotides or inhibitors of the BH<sub>3</sub>-binding pocket will promote formation of Bak- or Bax-induced pores in the mitochondrial outer membrane. **3.** Epigenetic silencing of APAF-1, caspase-8, and other proteins can be overcome using demethylating agents and inhibitors of histone deacetylases. **4.** Inhibitor of apoptosis proteins (IAP) blocks activation of caspases; small-molecule inhibitors of IAP function (mimicking SMAC action) should lower the threshold for apoptosis. **5.** Signal transduction pathways originating with activation of receptor tyrosine kinase receptors (RTKs) or cytokine receptors promote survival of cancer cells by a number of mechanisms. Inhibiting

BH<sub>3</sub>-only proteins. These compounds inhibit the antiapoptotic activities of Bcl-2 and Bcl-XL at nanomolar concentrations and will soon be entering clinical trials, first as single agents and then in combination with cytotoxic agents.

receptor function with monoclonal antibodies, such as trastuzumab or cetuximab, or inhibiting kinase activity with small-molecule inhibitors can block the pathway. **6.** The Akt kinase phosphorylates many regulators of apoptosis to promote cell survival; inhibitors of Akt may render tumor cells more sensitive to apoptosis-inducing signals; however, the possibility of toxicity to normal cells may limit the therapeutic value of these agents. **7** and **8.** Activation of the transcription factor NFκB (composed of p65 and p50 subunits) occurs when its inhibitor, IκB, is phosphorylated by IκB-kinase (IKK), with subsequent degradation of IκB by the proteasome. Inhibition of IKK activity should selectively block the activation of NFκB target genes, many of which promote cell survival. Inhibitors of proteasome function are FDA approved and may work in part by preventing destruction of IκB, thus blocking NFκB nuclear localization. NFκB is unlikely to be the only target for proteasome inhibitors.

Preclinical studies targeting death receptors DR4 and -5 have demonstrated that recombinant, soluble, human TRAIL or humanized monoclonal antibodies with agonist activity against DR4 or -5 can induce apoptosis of tumor cells while sparing normal cells. The mechanisms

for this selectivity may include expression of decoy receptors or elevated levels of intracellular inhibitors (such as FLIP, which competes with caspase-8 for FADD) by normal cells but not tumor cells. Synergy has been shown between TRAIL-induced apoptosis and chemotherapeutic agents. For instance, some colon cancers encode mutated Bax protein as the result of mismatch repair (MMR) defects and are resistant to TRAIL. However, upregulation of Bak by chemotherapy restores the ability of TRAIL to activate the mitochondrial pathway of apoptosis. In early-phase clinical trials, agonistic antibodies for DR4 and -5 and recombinant TRAIL trimers have led to the stabilization of tumor growth with a few cases of tumor shrinkage; however, studies have not yet shown that clinical activity correlates with activation of the extrinsic pathway of apoptosis.

Many of the signal transduction pathways perturbed in cancer promote tumor cell survival (Fig. 24-5). These include activation of the PI3K/Akt pathway, increased levels of the NF $\kappa$ B transcription factor, and epigenetic silencing of genes such as APAF-1 and caspase-8. Each of these pathways is a target for therapeutic agents that, in addition to affecting cancer cell proliferation or gene expression, may render cancer cells more susceptible to apoptosis, thus promoting synergy when combined with other chemotherapeutic agents.

Some tumor cells resist drug-induced apoptosis by expression of one or more members of the ABC family of ATP-dependent efflux pumps that mediate the multidrug resistance (MDR) phenotype. The prototype, P-glycoprotein (PGP), spans the plasma membrane 12 times and has two ATP-binding sites. Hydrophobic drugs (e.g., anthracyclines and vinca alkaloids) are recognized by PGP as they enter the cell and are pumped out. Numerous clinical studies have failed to demonstrate that drug resistance can be overcome using inhibitors of PGP. However, ABC transporters have different substrate specificities, and inhibition of a single family member may not be sufficient to overcome the MDR phenotype. A more rational targeting of specific transporters expressed by distinct tumor types may lead to increased efficacy.

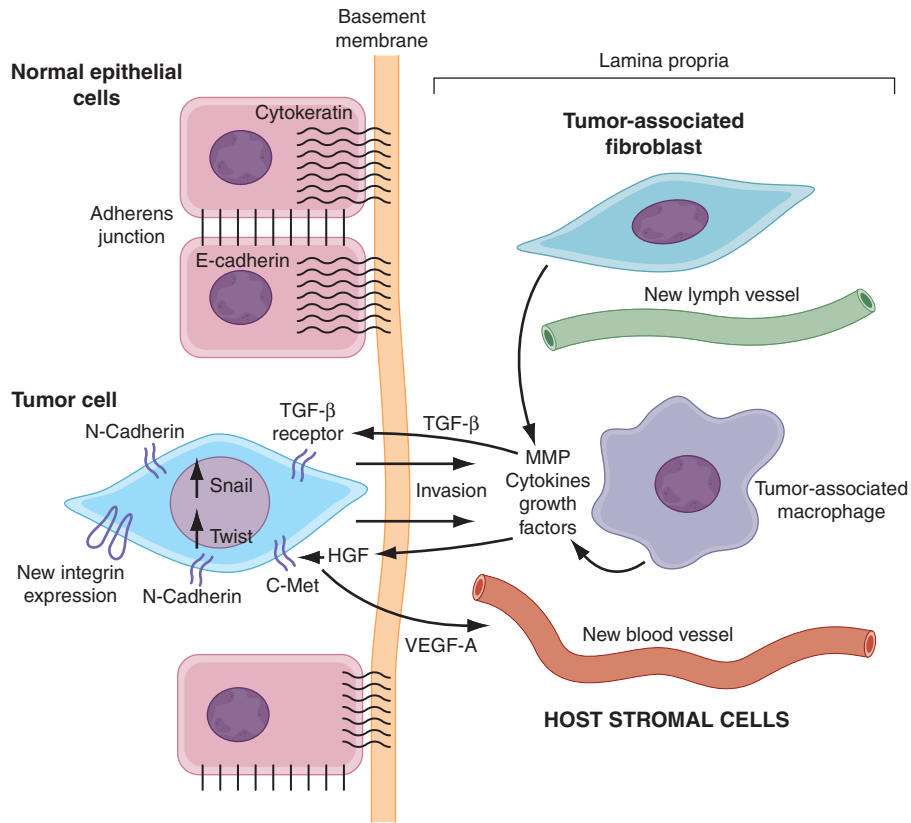
### **METASTASIS: DETERMINING RISK AND DEVELOPING THERAPEUTIC STRATEGIES**

The three major features of tissue invasion are cell adhesion to the basement membrane, local proteolysis of the membrane, and movement of the cell through the rent in the membrane and the ECM. Malignant cells that gain access to the circulation must then repeat those steps at a remote site, find a hospitable niche in a foreign

tissue, and induce the growth of new blood vessels. There are currently few drugs that directly target the process of metastasis. Metalloproteinase inhibitors (see “Tumor Angiogenesis,” later) represent an initial attempt to inhibit the migration of tumor cells into blood and lymphatic vessels. The rate-limiting step for metastasis is the ability for tumor cells to survive and expand in the novel microenvironment of the metastatic site, and multiple host-tumor interactions determine the ultimate outcome (Fig. 24-6).

The metastatic phenotype may be a characteristic of all cells constituting the primary tumor; however, it is likely that variants with metastatic potential arise due to genetic and epigenetic events that characterize tumor progression (Fig. 24-6). A number of candidate metastasis-suppressor genes have been identified. The loss of function of these genes enhances metastasis, and although the molecular mechanisms are in many cases uncertain, one common theme is an enhancing of the ability of the metastatic tumor cells to overcome the many apoptosis signals they encounter during the metastatic process. Gene expression profiling is being used to study the metastatic process with the goal of identifying signatures characteristic of primary tumors that have a high propensity to metastasize, leading to a more rational basis for the use of adjuvant chemotherapy.

Bone metastases are extremely painful, cause fractures of weight-bearing bones, can lead to hypercalcemia, and are a major cause of morbidity for cancer patients. Osteoclasts and their monocyte-derived precursors express the surface receptor RANK (receptor activator of NF $\kappa$ B), which is required for terminal differentiation and activation of osteoclasts. Osteoblasts and other stromal cells express RANK ligand, as both a membrane-bound and soluble cytokine. Osteoprotegerin (OPG), a soluble receptor for RANK ligand produced by stromal cells, acts as a decoy receptor to inhibit RANK activation. The relative balance of RANK ligand and OPG determines the activation state of RANK on osteoclasts. Many tumors increase osteoclast activity by secretion of substances such as parathyroid hormone (PTH), PTH-related peptide, interleukin (IL)-1, or Mip1 that perturb the homeostatic balance of bone remodeling by increasing RANK signaling. One example is multiple myeloma, where tumor cell-stromal cell interactions activate osteoclasts and inhibit osteoblasts, leading to the development of multiple lytic bone lesions. Inhibition of RANK ligand by IV administration of recombinant OPG or the extracellular domain of RANK linked to an immunoglobulin Fc-receptor (RANK-Fc) can prevent further bone destruction. Bisphosphonates are also effective inhibitors of osteoclast function that are used in the treatment of cancer patients with bone metastases.



**FIGURE 24-6**  
**Oncogene signaling pathways are activated during tumor progression and promote metastatic potential.** This figure shows a cancer cell that has undergone epithelial to mesenchymal transition (EMT) under the influence of several environmental signals. Critical components include activated transforming growth factor beta (TGF- $\beta$ ) and the hepatocyte growth factor (HGF)/c-Met pathways, as well as changes in the expression of adhesion molecules that mediate cell-cell and cell-extracellular matrix interactions. Important changes in gene expression are mediated by the Snail and Twist family of transcriptional repressors (whose expression is induced by the oncogenic pathways), leading to reduced expression of E-cadherin, a key component of adherens junctions between epithelial cells. This, in conjunction with upregulation of N-cadherin, a change in the pattern of expression of integrins (which mediate cell-extracellular

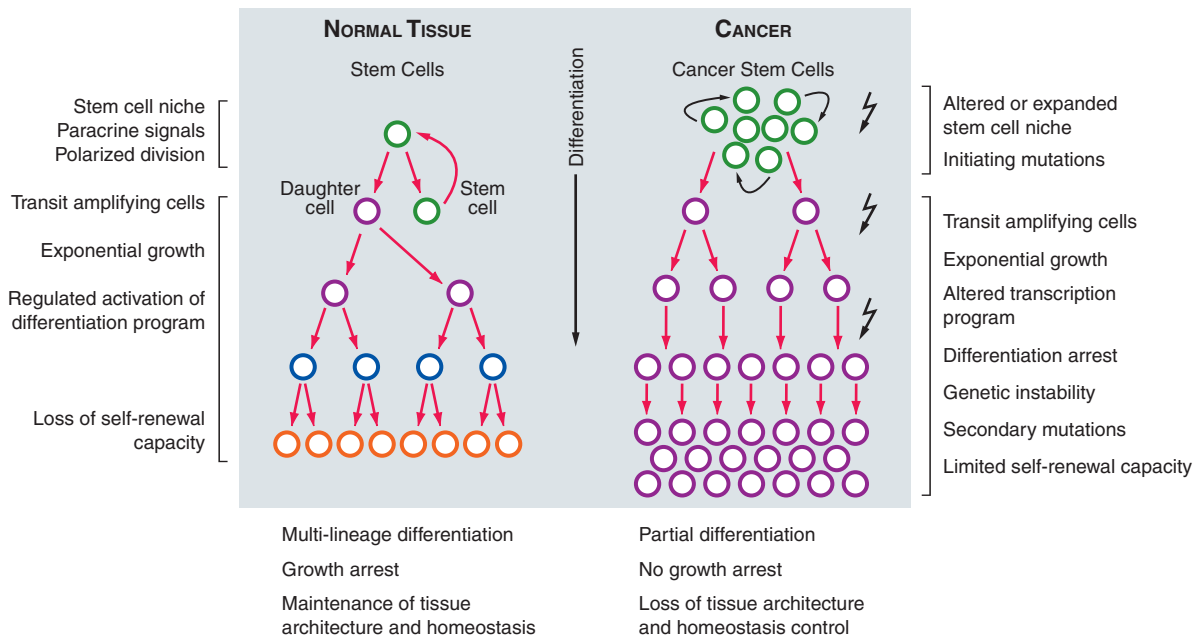
matrix interactions, and a switch in intermediate filament expression from cytokeratin to vimentin, results in the phenotypic change from adherent highly organized epithelial cells to motile and invasive cells with a fibroblast or mesenchymal morphology. EMT is thought to be an important step leading to metastasis in some human cancers. Host stromal cells, including tumor-associated fibroblasts and macrophages, play an important role in modulating tumor cell behavior through secretion of growth factors and proangiogenic cytokines, and matrix metalloproteinases that degrade the basement membrane. VEGF-A, -C, and -D are produced by tumor cells and stromal cells in response to hypoxia or oncogenic signals, and they induce production of new blood vessels and lymphatic channels through which tumor cells metastasize to lymph nodes or tissues.

## NEW CONCEPTS IN THE DEVELOPMENT OF CANCER THERAPEUTICS

### CANCER STEM CELLS

It has long been recognized that only a small proportion of the cells within a tumor are capable of initiating colonies in vitro or of forming tumors at high efficiency when injected into immunocompromised NOD/SCID mice. Current work indicates that human acute and chronic myeloid leukemias (AML and CML) have a small

population of cells (<1%) that have properties of stem cells, such as unlimited self-renewal and the capacity to cause leukemia when serially transplanted in mice. These cells have an undifferentiated phenotype (Thy1<sup>-</sup>CD34<sup>+</sup>CD38<sup>-</sup>, and negative for other differentiation markers) and resemble normal stem cells in many ways, but they are no longer under homeostatic control (Fig. 24-7). Solid tumors may also contain a population of stem cells. Cancer stem cells, like their normal counterparts, have unlimited proliferative capacity and paradoxically traverse the cell cycle at a very slow rate; cancer growth occurs largely due to expansion of the stem cell pool, the unregulated proliferation of the



**FIGURE 24-7**

**Cancer stem cells play a critical role in the initiation, progression, and resistance to therapy of malignant neoplasms.** In normal tissues (*left*), homeostasis is maintained by asymmetric division of stem cells leading to one progeny cell that will differentiate and one cell that will maintain the stem cell pool. This occurs within highly specific niches unique to each tissue, such as in close apposition to osteoblasts in bone marrow or at the base of crypts in the colon. Here, paracrine signals from stromal cells, such as sonic hedgehog or Notch ligands, as well as upregulation of  $\beta$ -catenin and telomerase, help to maintain stem cell features of unlimited self-renewal while preventing differentiation or cell death. This occurs in part through upregulation of the transcriptional repressor Bmi-1 and inhibition of the  $p16^{\text{Ink4a}}/\text{Arf}$  and p53 pathways. Daughter cells leave the stem cells niche and enter a proliferative phase (referred to as *transit-amplifying cells*) for a specified number of cell divisions, during which time a developmental program is activated, eventually giving rise to fully differentiated cells that have lost proliferative potential. Cell renewal equals cell death and homeostasis is maintained. In this hierarchal system, only stem cells are long-lived. Recent evidence has led to the hypothesis that cancers harbor stem cells that make up a

small fraction (i.e., 0.001–1%) of all cancer cells. These cells share several features with normal stem cells, including an undifferentiated phenotype, unlimited self-renewal potential, and a capacity for some degree of differentiation; however, due to initiating mutations (mutations are indicated by lightning bolts), they are no longer regulated by environmental cues. The cancer stem cell pool is expanded, and rapidly proliferating progeny, through additional mutations, may attain stem cell properties, although most of this population is thought to have a limited proliferative capacity. Differentiation programs are dysfunctional due to reprogramming of the pattern of gene transcription by oncogenic signaling pathways. Within the cancer transit-amplifying population, genomic instability generates aneuploidy and clonal heterogeneity as cells attain a fully malignant phenotype with metastatic potential. The cancer stem cell hypothesis has led to the idea that current cancer therapies may be effective at killing the bulk of tumor cells but do not kill tumor stem cells, leading to a regrowth of tumors that is manifested as tumor recurrence or disease progression. Research is in progress to identify unique molecular features of cancer stem cells that can lead to their direct targeting by novel therapeutic agents.

transit amplifying population, and failure of apoptosis pathways (Fig. 24-7). Slow cell cycle progression, plus high levels of expression of anti-apoptotic Bcl-2 family members and drug efflux pumps of the MDR family, render cancer stem cells less vulnerable to cancer chemotherapy or radiation therapy. Implicit in the cancer stem cell hypothesis is the idea that failure to cure most human cancers is due to the fact that current therapeutic agents do not kill the stem cells. If cancer stem cells can be identified and isolated, then aberrant signaling pathways that distinguish these cells from normal tissue stem cells can be identified and targeted.

Oncologists eagerly await a new class of agent that may directly attack the cells that drive tumor growth.

## ONCOGENE ADDICTION AND SYNTHETIC LETHALITY

The concepts of oncogene addiction and synthetic lethality have spurred new drug development targeting oncogene and tumor-suppressor pathways. As discussed earlier in this chapter and outlined in Fig. 24-3, cancer cells become physiologically dependent on signaling

310 pathways containing activated oncogenes; this can effect proliferation (i.e., mutated Ras, BRAF, overexpressed Myc, or activated tyrosine kinases), survival (overexpression of Bcl-2 or NFκB), cell metabolism (as occurs when HIF-1α and Akt increase dependence on glycolysis), and perhaps angiogenesis (production of VEGF, e.g., renal cell cancer). In such cases, targeted inhibition of the pathway can lead to specific killing of the cancer cells. However, targeting defects in tumor-suppressor genes has been much more difficult because the target of the mutation is often deleted. However, identifying genes that have a synthetic lethal relationship to tumor-suppressor pathways may allow targeting of proteins required uniquely by the tumor cells (Fig. 24-3, panel B). Several examples of this have been identified. For instance, the von Hippel-Landau tumor-suppressor-protein is inactivated in 60% of renal cell cancers, leading to overexpression of HIF-1α and the subsequent activation of downstream genes that promote angiogenesis, proliferation, survival, and altered glucose metabolism. HIF-1α mRNA has a complex 5'-terminus that indirectly requires the activity of mTOR (via activation of p70S6K and inhibition of 4E-BP) for efficient protein translation. Inhibitors of mTOR block HIF-1α translation and have significant clinical activity in renal cell cancer. In this case, mTOR is a synthetic lethal to VHL loss (Fig. 24-3), and its inhibition results in selective killing of cancer cells. Conceptually, this provides a framework for genetic screens to identify other synthetic lethal combinations involving known tumor-suppressor genes, and development of novel therapeutic agents to target dependent pathways.

In summary, our expanding knowledge of the genetic and molecular abnormalities in cancer cells, and their phenotypic correlates, has led to the development and FDA approval of a number of targeted pharmaceutical agents for the treatment of cancer (Table 24-2). This list will expand to include inhibitors of pathways currently under investigation and those yet to be discovered, yielding novel therapeutics with greater efficacy with less toxicity.

## TUMOR ANGIOGENESIS

The growth of primary and metastatic tumors to larger than a few millimeters requires the recruitment of neighboring blood vessels and vascular endothelial cells to support their metabolic requirements. The diffusion limit for oxygen in tissues is ~100 μm. A critical element in the growth of primary tumors and formation of metastatic sites is the *angiogenic switch*: the ability of the tumor to promote the formation of new capillaries from preexisting host vessels. The angiogenic switch is a phase in tumor development when the dynamic balance of pro- and antiangiogenic factors is tipped in favor of

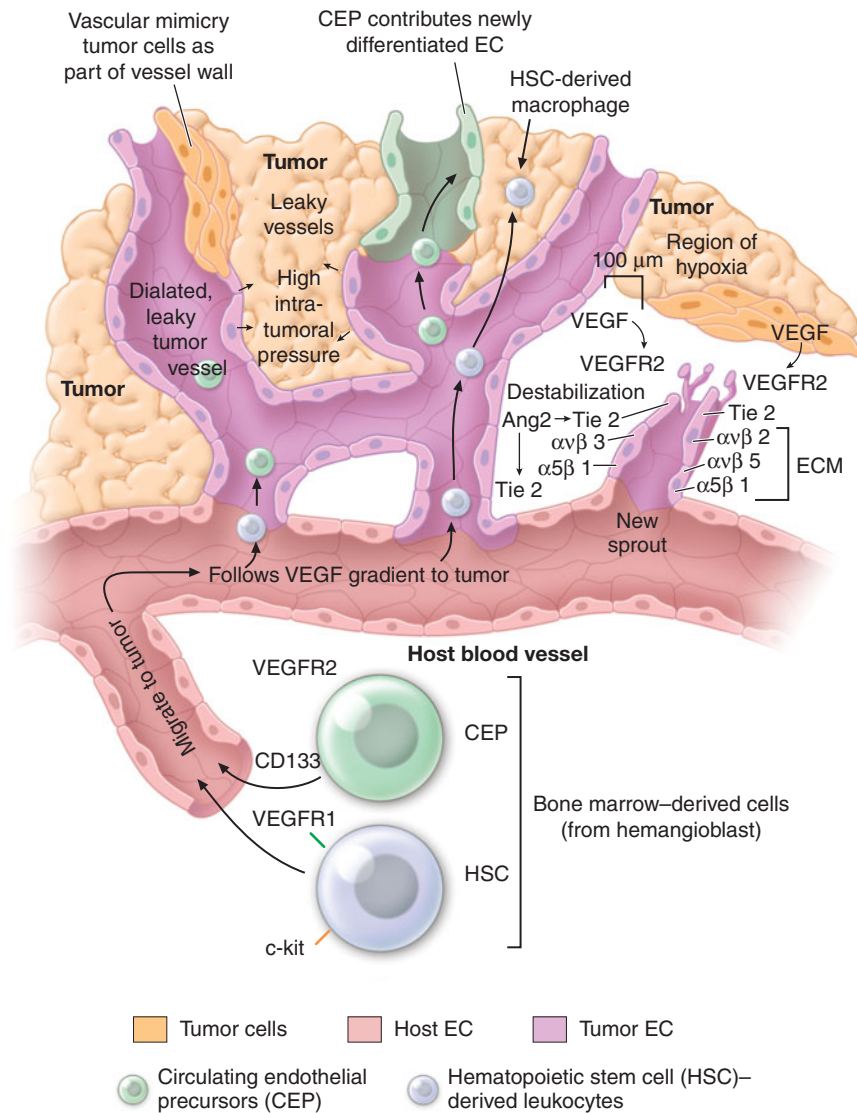
vessel formation by the effects of the tumor on its immediate environment. Stimuli for tumor angiogenesis include hypoxia, inflammation, and genetic lesions in oncogenes or tumor suppressors that alter tumor cell gene expression. Angiogenesis consists of several steps, including the stimulation of endothelial cells (ECs) by growth factors, the degradation of the ECM by proteases, proliferation of ECs and migration into the tumor, and the eventual formation of new capillary tubes.

Tumor blood vessels are not normal; they have chaotic architecture and blood flow. Due to an imbalance of angiogenic regulators such as VEGF and angiopoietins (see later), tumor vessels are tortuous and dilated with an uneven diameter, excessive branching, and shunting. Tumor blood flow is variable, with areas of hypoxia and acidosis leading to the selection of variants that are resistant to hypoxia-induced apoptosis (often due to the loss of p53 expression). Tumor vessel walls have numerous openings, widened interendothelial junctions, and discontinuous or absent basement membrane; this contributes to the high vascular permeability of these vessels and, together with lack of functional intratumoral lymphatics, causes interstitial hypertension within the tumor (which also interferes with the delivery of therapeutics to the tumor; Figs. 24-8, 24-9, and 24-10). Tumor blood vessels lack perivascular cells such as pericytes and smooth-muscle cells that normally regulate flow in response to tissue metabolic needs.

Unlike normal blood vessels, the vascular lining of tumor vessels is not a homogeneous layer of ECs but often consists of a mosaic of ECs and tumor cells; the concept of cancer cell-derived vascular channels, which may be lined by ECM secreted by the tumor cells, is referred to as vascular mimicry. It is unclear whether tumor cells actually form structural elements of vascular channels or represent tumor cells in transit into or out of the vessel. However, the former is supported by evidence that in some human colon cancers, tumor cells can comprise up to 15% of vessel walls. The ECs of angiogenic blood vessels are unlike quiescent ECs found in adult vessels, where only 0.01% of ECs are dividing. During tumor angiogenesis, ECs are highly proliferative and express a number of plasma membrane proteins that are characteristic of activated endothelium, including growth factor receptors and adhesion molecules such as integrins.

## MECHANISMS OF TUMOR VESSEL FORMATION

Tumors utilize a number of mechanisms to promote their vascularization, and in each case they subvert normal angiogenic processes to suit this purpose (Fig. 24-8). Primary or metastatic tumor cells sometimes arise in proximity to host blood vessels and grow around these vessels, parasitizing nutrients by coopting the local blood

**FIGURE 24-8**

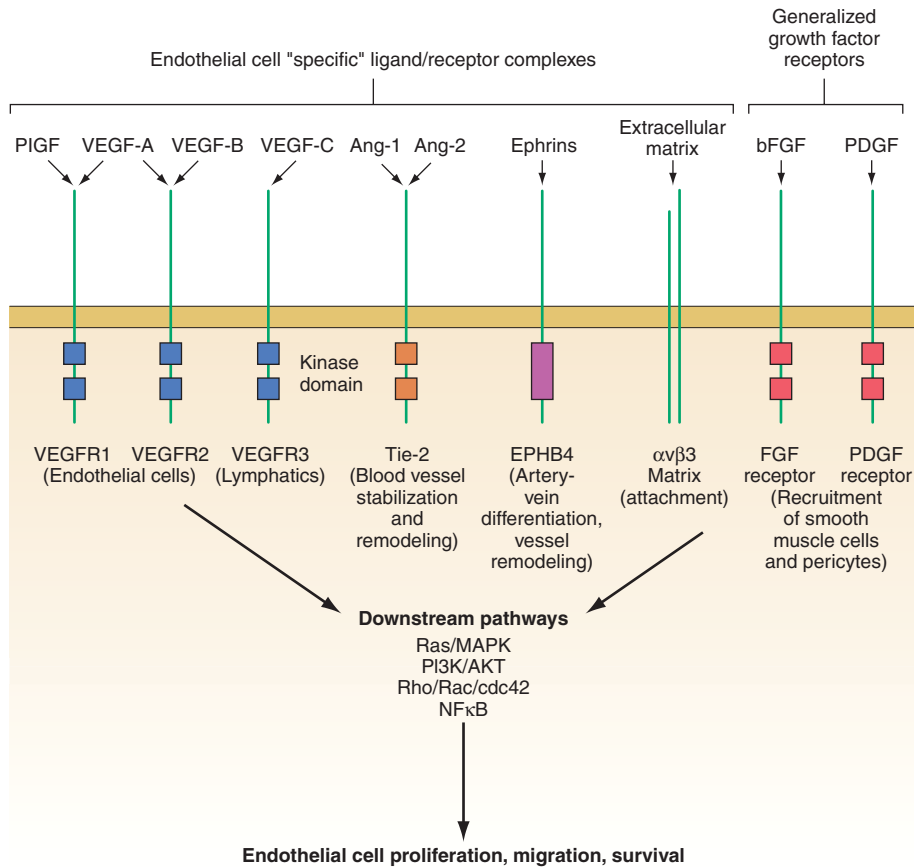
**Tumor angiogenesis** is a complex process involving many different cell types that must proliferate, migrate, invade, and differentiate in response to signals from the tumor microenvironment. Endothelial cells (ECs) sprout from host vessels in response to VEGF, bFGF, Ang2, and other proangiogenic stimuli. Sprouting is stimulated by VEGF/VEGFR2, Ang2/Tie-2, and integrin/extracellular matrix (ECM) interactions. Bone marrow-derived circulating endothelial precursors (CEPs) migrate to the tumor in response to VEGF and differentiate into ECs while hematopoietic stem cells differentiate into leukocytes, including

supply. However, most tumor blood vessels arise by the process of *sprouting*, in which tumors secrete trophic angiogenic molecules, the most potent being VEGF, that induce the proliferation and migration of host ECs into the tumor. Sprouting in normal and pathogenic angiogenesis is regulated by three families of transmembrane RTKs expressed on ECs and their ligands (VEGFs, angiopoietins, ephrins; Fig. 24-9), which are produced by tumor cells, inflammatory cells, or stromal cells in the tumor microenvironment.

tumor-associated macrophages that secrete angiogenic growth factors and produce MMPs that remodel the ECM and release bound growth factors. Tumor cells themselves may directly form parts of vascular channels within tumors. The pattern of vessel formation is haphazard: vessels are tortuous, dilated, leaky, and branch in random ways. This leads to uneven blood flow within the tumor, with areas of acidosis and hypoxia (which stimulate release of angiogenic factors) and high intratumoral pressures that inhibit delivery of therapeutic agents.

When tumor cells arise in or metastasize to an avascular area, they grow to a size limited by hypoxia and nutrient deprivation. Hypoxia, a key regulator of tumor angiogenesis, causes the transcriptional induction of the gene encoding VEGF by a process that involves stabilization of HIF-1 $\alpha$ . Under normoxic conditions, HIF-1 $\alpha$  levels are maintained at a low level by proteasome-mediated destruction regulated by a ubiquitin E3-ligase encoded by the VHL tumor-suppressor locus. However, under hypoxic conditions, HIF-1 $\alpha$  is not hydroxylated





**FIGURE 24-9**

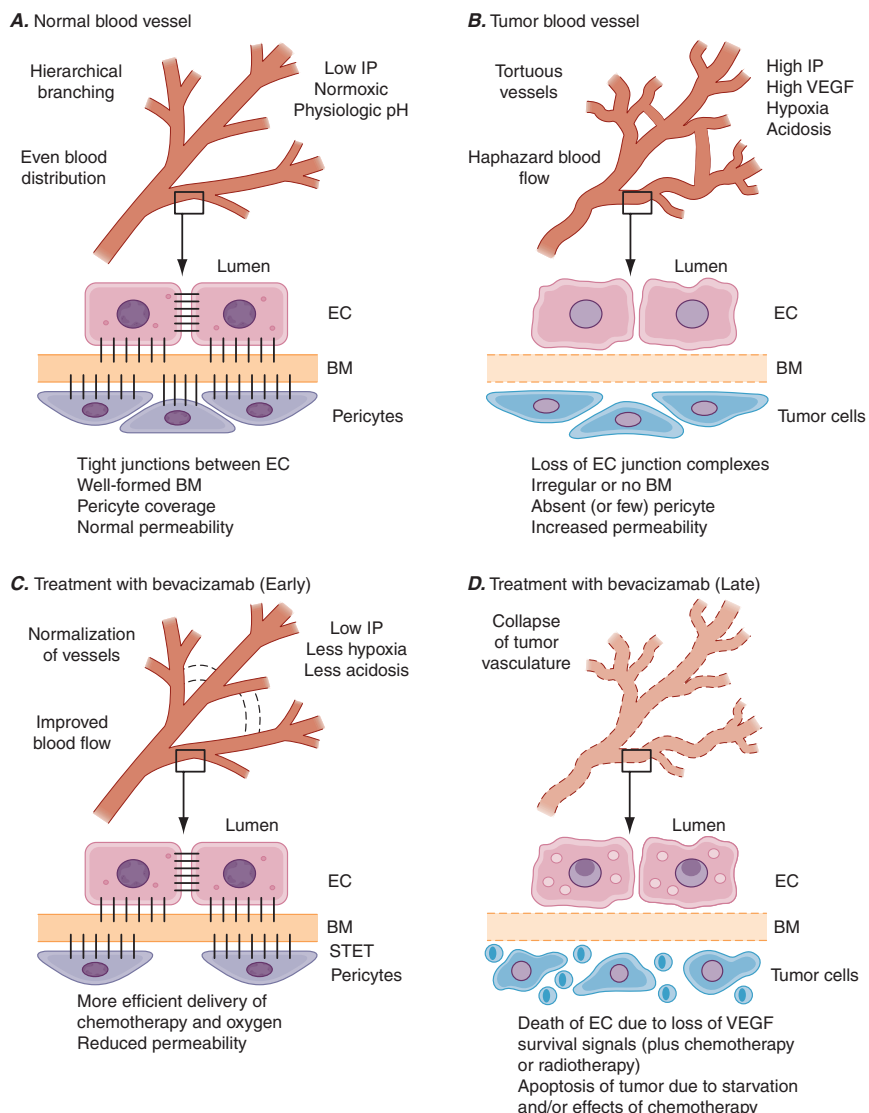
**Critical molecular determinants of endothelial cell biology.** Angiogenic endothelium expresses a number of receptors not found on resting endothelium. These include receptor tyrosine kinases (RTKs) and integrins that bind to the extracellular matrix and mediate the adhesion, migration, and invasion of endothelial cells (ECs). ECs also express RTK (i.e., the FGF and PDGF receptors) that are found on many

other cell types. Critical functions mediated by activated RTK include proliferation, migration, and enhanced survival of ECs, as well as regulation of the recruitment of perivascular cells and bloodborne circulating endothelial precursors and hematopoietic stem cells to the tumor. Intracellular signaling via EC-specific RTK utilizes molecular pathways that may be targets for future antiangiogenic therapies.

and association with VHL does not occur; therefore HIF-1 levels increase, and target genes including VEGF, nitric oxide synthetase (NOS), and Ang2 are induced. Loss of the *VHL* genes, as occurs in familial and sporadic renal cell carcinomas, results in HIF-1 $\alpha$  stabilization and induction of VEGF. Most tumors have hypoxic regions due to poor blood flow, and tumor cells in these areas stain positive for HIF-1 $\alpha$  expression; in renal cancers with *VHL* deletion, all of the tumor cells express high levels of HIF-1 $\alpha$ , and VEGF-induced angiogenesis leads to high microvascular density (hence the term *hypernephroma*).

VEGF and its receptors are required for *vasculogenesis* (the de novo formation of blood vessels from differentiating endothelial cells, as occurs during embryonic development) and angiogenesis under normal (wound healing, corpus luteum formation) and pathologic

processes (tumor angiogenesis, inflammatory conditions such as rheumatoid arthritis). VEGF-A is a heparin-binding glycoprotein with at least four isoforms (splice variants) that regulates blood vessel formation by binding to the RTKs VEGFR1 and VEGFR2, which are expressed on all ECs in addition to a subset of hematopoietic cells (Fig. 24-8). VEGFR2 regulates EC proliferation, migration, and survival; VEGFR1 may act as an antagonist of R1 in ECs but is probably also important for angioblast differentiation during embryogenesis. Tumor vessels appear to be more dependent on VEGFR signaling for growth and survival than normal ECs. Although VEGF signaling is a critical initiator of angiogenesis, this is a complex process regulated by additional signaling pathways (Fig. 24-9). The angiopoietin Ang1, produced by stromal cells, binds to the EC RTK Tie-2 and promotes the interaction of ECs with

**FIGURE 24-10****Normalization of tumor blood vessels due to inhibition of VEGF signaling.**

**A.** Blood vessels in normal tissues exhibit a regular hierarchical branching pattern that delivers blood to tissues in a spatially and temporally efficient manner to meet the metabolic needs of the tissue (top). At the microscopic level, tight junctions are maintained between endothelial cells (EC), which are adherent to a thick and evenly distributed basement membrane (BM). Pericytes form a surrounding layer that provides trophic signals to the EC and helps maintain proper vessel tone. Vascular permeability is regulated, interstitial fluid pressure is low, and oxygen tension and pH are physiologic. **B.** Tumors have abnormal vessels with tortuous branching and dilated, irregular interconnecting branches, causing uneven blood flow with areas of hypoxia and acidosis. This harsh environment selects genetic events that result in resistant tumor variants, such as the loss of p53. High levels of VEGF (secreted by tumor cells) disrupt gap junction communication, tight junctions, and adherens junctions between EC via src-mediated phosphorylation of proteins such as connexin 43, zonula occludens-1, VE-cadherin, and  $\alpha/\beta$ -catenins. Tumor vessels have thin, irregular BM, and pericytes are

sparse or absent. Together, these molecular abnormalities result in a vasculature that is permeable to serum macromolecules, leading to high tumor interstitial pressure, which can prevent the delivery of drugs to the tumor cells. This is made worse by the binding and activation of platelets at sites of exposed BM, with release of stored VEGF and microvessel clot formation, creating more abnormal blood flow and regions of hypoxia. **C.** In experimental systems, treatment with bevacizumab or blocking antibodies to VEGFR2 leads to changes in the tumor vasculature that has been termed *vessel normalization*. During the first week of treatment, abnormal vessels are eliminated or pruned (dotted lines), leaving a more normal branching pattern. ECs partially regain features such as cell-cell junctions, adherence to a more normal BM, and pericyte coverage. These changes lead to a decrease in vascular permeability, reduced interstitial pressure, and a transient increase in blood flow within the tumor. Note that in murine models, this normalization period lasts only for ~5–6 days. **D.** After continued anti-VEGF/VEGFR therapy (which is often combined with chemo- or radiotherapy), ECs die, leading to tumor cell death (either due to direct effects of the chemotherapy or lack of blood flow).

314 the ECM and perivascular cells, such as pericytes and smooth-muscle cells, to form tight, nonleaky vessels. PDGF and basic fibroblast growth factor (bFGF) help to recruit these perivascular cells. Ang1 is required for maintaining the quiescence and stability of mature blood vessels and prevents the vascular permeability normally induced by VEGF and inflammatory cytokines.

For tumor cell-derived VEGF to initiate sprouting from host vessels, the stability conferred by the Ang1/Tie2 pathway must be perturbed; this occurs by the secretion of Ang2 by ECs that are undergoing active remodeling. Ang2 binds to Tie2 and is a competitive inhibitor of Ang1 action: under the influence of Ang2, preexisting blood vessels become more responsive to remodeling signals, with less adherence of ECs to stroma and associated perivascular cells and more responsiveness to VEGF. Therefore, Ang2 is required at early stages of tumor angiogenesis for destabilizing the vasculature by making host ECs more sensitive to angiogenic signals. Because tumor ECs are blocked by Ang2, there is no stabilization by the Ang1/Tie2 interaction, and tumor blood vessels are leaky, hemorrhagic, and have poor association of ECs with underlying stroma. Sprouting tumor ECs express high levels of the transmembrane protein ephrin-B2 and its receptor, the RTK EPH whose signaling appears to work with the angiopoietins during vessel remodeling. During embryogenesis, EPH receptors are expressed on the endothelium of primordial venous vessels while the transmembrane ligand ephrin-B2 is expressed by cells of primordial arteries; the reciprocal expression may regulate differentiation and patterning of the vasculature.

A number of ubiquitously expressed host molecules play critical roles in normal and pathologic angiogenesis. Proangiogenic cytokines, chemokines, and growth factors secreted by stromal cells or inflammatory cells make important contributions to neovascularization, including bFGF, transforming growth factor- $\alpha$  (TGF- $\alpha$ ), TNF- $\alpha$ , and IL-8. In contrast to normal endothelium, angiogenic endothelium overexpresses specific members of the integrin family of ECM-binding proteins that mediate EC adhesion, migration, and survival. Specifically, expression of integrins  $\alpha_v\beta_3$ ,  $\alpha_v\beta_5$ , and  $\alpha_5\beta_1$  mediate spreading and migration of ECs and are required for angiogenesis induced by VEGF and bFGF, which in turn can upregulate EC integrin expression. The  $\alpha_v\beta_3$  integrin physically associates with VEGFR2 in the plasma membrane and promotes signal transduction from each receptor to promote EC proliferation (via focal adhesion kinase, src, PI3K, and other pathways) and survival (by inhibition of p53 and increasing the Bcl-2/Bax expression ratio). In addition,  $\alpha_v\beta_3$  forms cell surface complexes with matrix metalloproteinases (MMPs), zinc-requiring proteases that cleave ECM proteins, leading to enhanced EC migration and the release of heparin-binding growth factors including VEGF and bFGF. EC adhesion molecules can be upregulated (i.e., by VEGF, TNF- $\alpha$ ) or downregulated (by TGF- $\beta$ );

this, together with chaotic blood flow, explains poor leukocyte-endothelial interactions in tumor blood vessels and may help tumor cells avoid immune surveillance.

Cells derived from hematopoietic progenitors in the host bone marrow contribute to tumor angiogenesis in a process linked to the secretion of VEGF and PlGF (placenta-derived growth factor) by tumor cells and their surrounding stroma. VEGF promotes the mobilization and recruitment of circulating endothelial cell precursors (CEPs) and hematopoietic stem cells (HSCs) to tumors where they colocalize and appear to cooperate in neovessel formation. CEPs express VEGFR2; HSCs express VEGFR1, a receptor for VEGF and PlGF. Both CEPs and HSCs are derived from a common precursor, the hemangioblast. CEPs are thought to differentiate into ECs, whereas the role of HSC-derived cells (such as tumor-associated macrophages) may be to secrete angiogenic factors required for sprouting and stabilization of ECs (VEGF, bFGF, angiopoietins) and to activate MMPs, resulting in ECM remodeling and growth factor release. In mouse tumor models and in human cancers, increased numbers of CEPs and subsets of VEGFR-expressing HSCs can be detected in the circulation, which may correlate with increased levels of serum VEGF. It is not yet known whether levels of these cells have prognostic value or if changes during treatment correlate with inhibition of tumor angiogenesis. Whether CEPs and VEGFR1-expressing HSCs are required to maintain the long-term integrity of established tumor vessels is also unknown.

Lymphatic vessels also exist within tumors. Development of tumor lymphatics is associated with expression of VEGFR3 and its ligands VEGF-C and VEGF-D. The role of these vessels in tumor cell metastasis to regional lymph nodes remains to be determined because, as discussed earlier, interstitial pressures within tumors are high and most lymphatic vessels may exit in a collapsed and nonfunctional state. However, VEGF-C levels correlate significantly with metastasis to regional lymph nodes in lung, prostate, and colorectal cancers,

## ANTIANGIOGENIC THERAPY

Understanding the molecular mechanisms that regulate tumor angiogenesis may provide unique opportunities for cancer treatment. Acquired drug resistance of tumor cells due to their high intrinsic mutation rate is a major cause of treatment failure in human cancers. ECs comprising the tumor vasculature are genetically stable and do not share genetic changes with tumor cells; the EC apoptosis pathways are therefore intact. Each EC of a tumor vessel helps provide nourishment to many tumor cells, and although tumor angiogenesis can be driven by a number of exogenous proangiogenic stimuli, experimental data indicate that at least in some tumor types, blockade of a single growth factor (e.g., VEGF) may inhibit tumor-induced vascular growth. Angiogenesis inhibitors function by

TABLE 24-3

RANDOMIZED PHASE III CLINICAL TRIALS DEMONSTRATING THE EFFICACY OF BEVACIZUMAB IN COMBINATION WITH CHEMOTHERAPY FOR THE TREATMENT OF ADVANCED CANCERS					
TUMOR TYPE	STAGE OF DISEASE	PREVIOUS TREATMENT	NUMBER OF PATIENTS	CHEMOTHERAPY REGIMEN	OUTCOME
Colon cancer	Metastatic	No	813	Irinotecan + 5-FU/LV ± bevacizumab	Increased OS (20.3 vs 15.6 months), PFS (10.6 vs 6.2 months), and RR (44.8 vs 34.8%)
Colon cancer	Metastatic	Second line; previous irinotecan/5-FU	829	FOLFOX ± bevacizumab	Increased OS (12.9 vs 10.8 months), PFS (7.2 vs 4.8 months), RR (21.8 vs 9.2%)
Non-small cell lung cancer (excluding squamous histology)	Metastatic	No	878	Carboplatin + paclitaxel ± bevacizumab	Increased OS (12.5 vs 10.2 months), PFS (6.4 vs 4.5 months), RR (27.2 vs 10.0%)
Breast cancer	Recurrent or metastatic	No	722	Paclitaxel ± bevacizumab	Increased PFS (11.0 vs 6.2 months), RR (28 vs 14%)

**Note:** 5-FU, 5-fluorouracil; LV, leucovorin; OS, overall survival; PFS, progression-free survival; RR, response rate; FOLFOX, folinic acid (LV), 5-FU, and oxaliplatin.

targeting the critical molecular pathways involved in EC proliferation, migration, and/or survival, many of which are unique to the activated endothelium in tumors. Inhibition of growth factor and adhesion-dependent signaling pathways can induce EC apoptosis with concomitant inhibition of tumor growth. Different types of tumors use distinct molecular mechanisms to activate the angiogenic switch. Therefore, it is doubtful that a single antiangiogenic strategy will suffice for all human cancers; rather, a number of agents will be needed, each responding to distinct programs of angiogenesis used by different human cancers.

Four randomized phase III clinical trials have demonstrated that the addition of bevacizumab (Avastin; a humanized monoclonal antibody that binds and inhibits VEGF) to chemotherapy results in significantly improved response rates, progression-free survival, and overall survival when compared to treatment with chemotherapy alone (Table 24-3). This effect was shown in the first-line treatment of patients with advanced colon, lung, and breast cancers, and in the second-line treatment of colon cancer. However, not all trials have been positive; in previously treated breast cancer, the addition of bevacizumab to capecitabine (an oral fluoropyrimidine) did not increase efficacy, and in previously untreated pancreatic cancer, bevacizumab did not enhance the efficacy of gemcitabine.

Several general principles have arisen from these studies. Bevacizumab appears to potentiate the effects of many different types of active chemotherapeutic regimens used to treat a variety of different tumor types. No phase III trials have demonstrated single-agent activity for bevacizumab; colon and lung cancer trials have demonstrated a lack of activity when used alone. An exception may be renal cell cancer (RCC), a tumor that is specifically

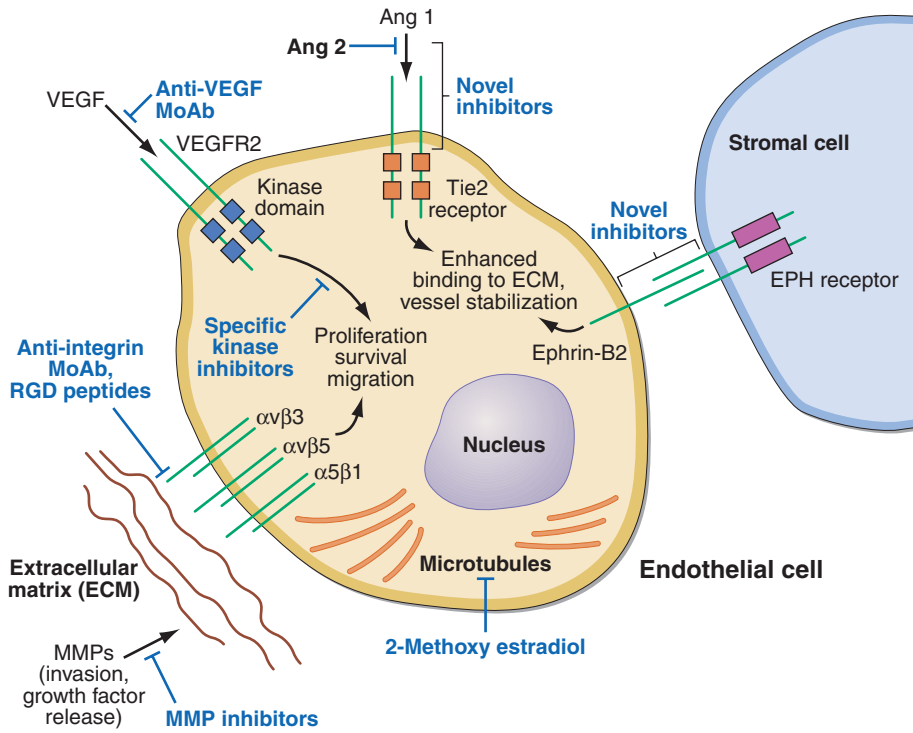
dependent on VEGF as the result of deletion of the VHL tumor suppressor and activation of the HIF-1 $\alpha$  transcription factor (see earlier). A randomized phase II study of single-agent bevacizumab given at low or high dose compared to placebo in patients with advanced RCC demonstrated a significant prolongation of time to disease progression, a finding that merits further study.

The mechanisms by which bevacizumab enhances the activity of chemotherapy and possibly radiotherapy have been studied (Table 24-4). Inhibition of VEGF, especially

TABLE 24-4

MECHANISMS OF BEVACIZUMAB ACTION
1. Inhibition of VEGF-dependent signaling pathways required for the proliferation and survival of endothelial cells within the tumor vasculature. This may enhance the direct toxic effects of chemotherapy on tumor endothelial cells.
2. Inhibition of vascular permeability, decreasing interstitial pressure in tumors, and promoting delivery of therapeutic drugs and oxygen (a process termed <i>vessel normalization</i> ).
3. Prevention of neoangiogenesis between cycles of chemotherapy, blocking tumor regrowth.
4. Inhibition of the recruitment of proangiogenic bone marrow-derived cells (including circulating endothelial precursors and monocytes) to the tumor vasculature.
5. Blocking potential direct effects of VEGF on tumors that have been reported to express VEGFR2, e.g., colon and pancreatic cancer cells.
6. Reversing the inhibitory activity of VEGF on dendritic cells, thereby promoting antitumor immunity.

**Note:** VEGF(R), vascular endothelial growth factor (receptor).



**FIGURE 24-11**

**Knowledge of the molecular events governing tumor angiogenesis has led to a number of therapeutic strategies to block tumor blood vessel formation.** The successful therapeutic targeting of VEGF is described in the text. Other endothelial cell-specific receptor tyrosine kinase pathways (e.g., angiopoietin/Tie2 and ephrin/EPH) are likely targets for the future. Ligation of the  $\alpha_v\beta_3$  integrin is required for EC survival. Integrins are also required for EC migration and are important regulators of matrix metalloproteinase (MMP) activity, which modulates EC movement through the ECM as well as release of bound growth factors. Targeting of integrins includes development of blocking antibodies, small peptide inhibitors of integrin signaling, and arg-gly-asp-containing peptides that prevent integrin:ECM binding. Peptides derived from normal proteins by

proteolytic cleavage, including endostatin and tumstatin, inhibit angiogenesis by mechanisms that include interfering with integrin function. Signal transduction pathways that are dysregulated in tumor cells indirectly regulate EC function. Inhibition of EGF-family receptors, whose signaling activity is upregulated in a number of human cancers (e.g., breast, colon, and lung cancers), results in downregulation of VEGF and IL-8 while increasing expression of the antiangiogenic protein thrombospondin-1. The Ras/MAPK, PI3K/Akt, and Src kinase pathways constitute important antitumor targets that also regulate the proliferation and survival of tumor-derived EC. The discovery that EC from normal tissues express tissue-specific “vascular addressins” on their cell surface suggests that targeting specific EC subsets may be possible.

in the early stages of treatment, has been postulated to result in the normalization of blood flow in tumors (Fig. 24-10). When given in combination with chemotherapy, this may enhance the delivery of cytotoxic agents to the tumor, where death of tumor cells and proliferating endothelial cells may result. As antiangiogenic therapy continues, growth of new tumor vessels is inhibited, leading to nutritional deprivation and death of tumor cells.

Bevacizumab is administered IV every 2–3 weeks (its half-life is nearly 20 days) and is generally well tolerated. Hypertension has been noted in most trials that utilize inhibitors of VEGF receptors, but only 10% of patients require treatment with antihypertensive agents and this rarely requires discontinuation of therapy. A mechanism for the hypertension may be a bevacizumab-induced decrease in vessel production of nitric oxide, resulting in

vasoconstriction and increased blood pressure. Rare but serious side effects of bevacizumab include an increased risk of arterial thromboembolic events including stroke and myocardial infarction, usually in patients >65 years of age with a history of cardiovascular disease. An increased risk of hemorrhage was noted in lung cancer patients with a squamous histology and large central tumors near the major mediastinal blood vessels. Cavitation of the tumor with vessel rupture and massive hemoptysis led to the exclusion of squamous cell cancers from treatment with bevacizumab. This potentially fatal side effect may actually reflect an increased activity of bevacizumab plus chemotherapy in squamous cell cancers. Other serious complications include bowel perforations that have been observed in 1–3% of patients (mainly those with colon and ovarian cancers).

Important questions remain concerning the clinical use of bevacizumab. Do patients develop resistance to this agent? Although patients with advanced colon, lung, and breast cancers benefit from treatment with bevacizumab-containing regimens, few patients are cured and most will relapse and die of their disease. Although resistance of cancer cells to chemotherapeutic agents is expected, it is unclear to what extent the relapses reflect resistance to bevacizumab (if at all). Preclinical studies have demonstrated that inhibition of VEGF-mediated angiogenic pathways can select for tumor variants that utilize other angiogenic mechanisms, such as the secretion of the proangiogenic chemokine IL-8, which is a downstream mediator of the EGFR pathway. This has led to studies in which bevacizumab has been combined with cetuximab or erlotinib (inhibitors of EGFR signaling), and preliminary phase II studies have shown efficacy of these combinations in heavily pretreated patients with colon and lung cancers.

The bevacizumab experience suggests that inhibition of the VEGF pathway will be most efficacious when combined with agents that directly target tumor cells. This also appears to be the case in the development of small-molecule inhibitors (SMIs) that target VEGF receptor tyrosine kinase activity but are also inhibitory to other kinases that are expressed by tumor cells and important for their proliferation and survival. Sunitinib, FDA approved for the treatment of GIST (see earlier and Table 24-2), has activity directed against mutant c-Kit receptors but also targets VEGFR and PDGFR, and it has shown significant antitumor activity against metastatic RCC, presumably on the basis of its antiangiogenic activity. Similarly, sorafenib, originally developed as a Raf kinase inhibitor but with potent activity against VEGF and PDGF receptors, increases progression-free survival in RCC. Thus agents that target both angiogenesis and tumor-specific signaling pathways may have greater efficacy against a broad range of

cancers. A caveat is that RCC and GIST are highly dependent on single signaling pathways (VEGF and c-Kit, respectively) whereas most solid tumors use a panoply of interconnected proliferation and survival pathways that are redundant and likely to be less amenable to single-agent targeting.

The success in targeting tumor angiogenesis has led to enhanced enthusiasm for the development of drugs that target other aspects of the angiogenic process; some of these therapeutic approaches are outlined in [Fig. 24-11](#).

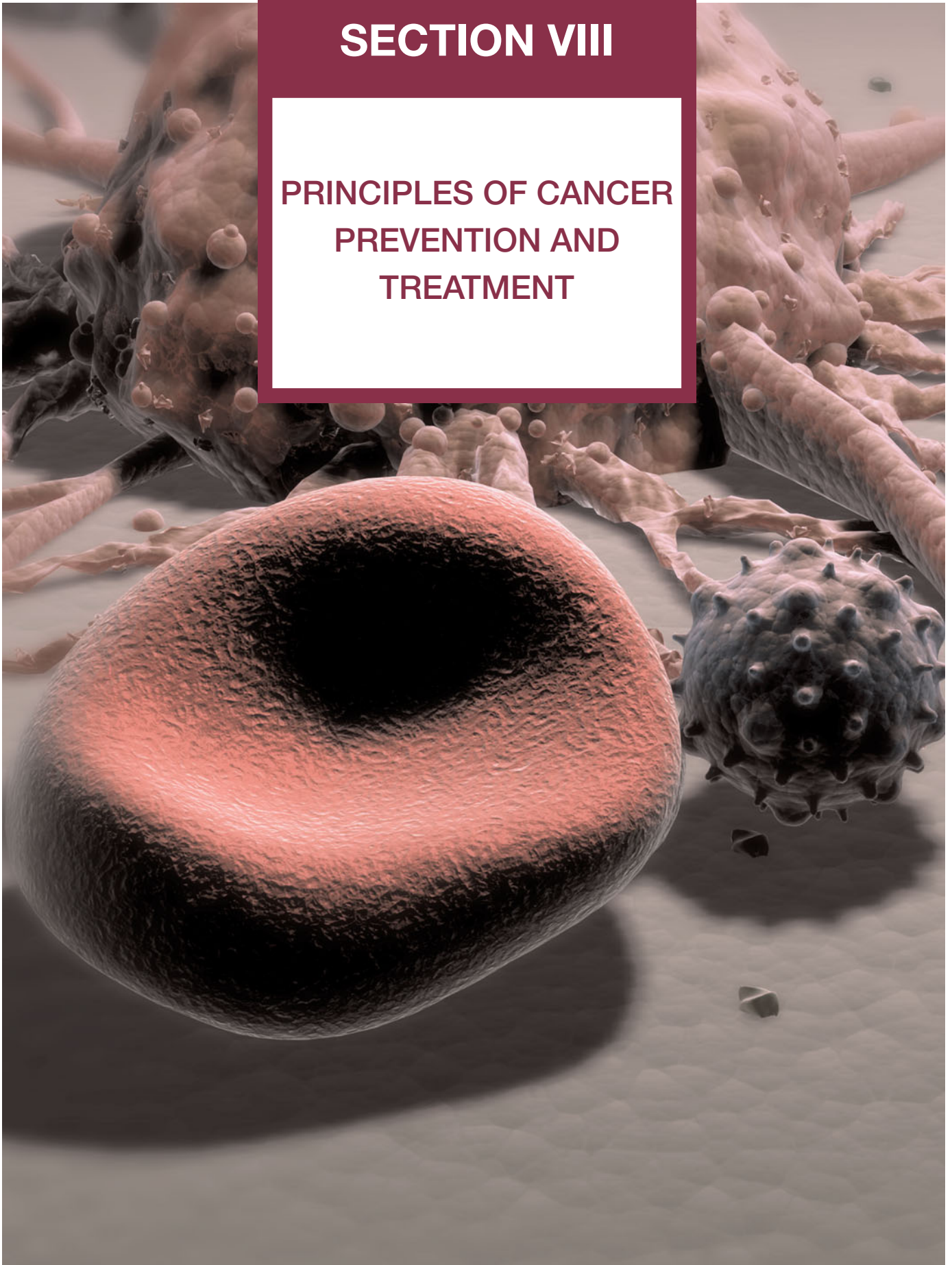
## FURTHER READINGS

- BILD AH et al: Oncogenic pathway signatures in human cancers as a guide to targeted therapies. *Nature* 439:353, 2006
- COTTER TG: Apoptosis and cancer: The genesis of a research field. *Nat Rev Cancer* 9:501, 2009
- DAI Y, GRANT S: Targeting multiple arms of the apoptotic regulatory machinery. *Cancer Res* 67:2908, 2007
- FERRARA N, KERBEL RS: Angiogenesis as a therapeutic target. *Nature* 438:967, 2005
- FINKEL T et al: The common biology of cancer and ageing. *Nature* 448:767, 2007
- HUBER MA et al: Molecular requirements for epithelial-mesenchymal transition during tumor progression. *Curr Opin Cell Biol* 17:548, 2005
- JOHNSTON LA: Competitive interactions between cells: Death, growth, and geography. *Science* 324:1679, 2009
- KAELIN WG JR: The concept of synthetic lethality in the context of anticancer therapy. *Nat Rev Cancer* 5:686, 2005
- MCDONALD SL, SILVER A: The opposing roles of Wnt-5a in cancer. *Br J Cancer* 101:209, 2009
- PANARES RL, GARCIA AA: Bevacizumab in the management of solid tumors. *Expert Rev Anticancer Ther* 7:434, 2007
- ROSEN JM, JORDAN CT: The increasing complexity of the cancer stem cell paradigm. *Science* 324:1670, 2009
- SHARMA SV et al: Epidermal growth factor receptor mutations in lung cancer. *Nat Rev Cancer* 7:169, 2007
- SHERBENOU DW, DRUCKER BJ: Applying the discovery of the Philadelphia chromosome. *J Clin Invest* 117:2068, 2007
- VOUSDEN KH, LANE DP: p53 in health and disease. *Nat Rev Mol Cell Biol* 8:275, 2007

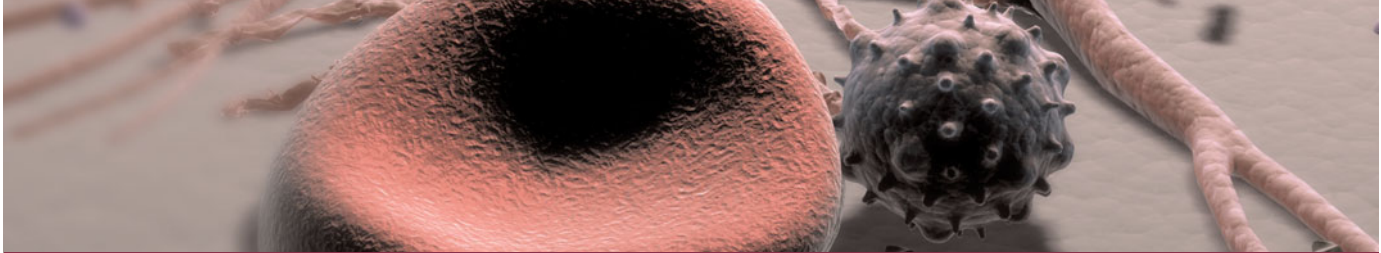
*This page intentionally left blank*

# SECTION VIII

## PRINCIPLES OF CANCER PREVENTION AND TREATMENT







## CHAPTER 25

# APPROACH TO THE PATIENT WITH CANCER

Dan L. Longo

■ The Magnitude of the Problem	320
Cancer Around the World	323
■ Patient Management	324
Diagnosis	324
Defining the Extent of Disease and the Prognosis	324
Making a Treatment Plan	326
Management of Disease and Treatment Complications	326
Long-Term Follow-Up/Late Complications	328
Supportive Care	328
■ Further Readings	331

The application of current treatment techniques (surgery, radiation therapy, chemotherapy, and biological therapy) results in the cure of nearly two of three patients diagnosed with cancer. Nevertheless, patients experience the diagnosis of cancer as one of the most traumatic and revolutionary events that has ever happened to them. Independent of prognosis, the diagnosis brings with it a change in a person's self-image and in his or her role in the home and workplace. The prognosis of a person who has just been found to have pancreatic cancer is the same as the prognosis of the person with aortic stenosis who develops the first symptoms of congestive heart failure (median survival, ~8 months). However, the patient with heart disease may remain functional and maintain a self-image as a fully intact person with just a malfunctioning part, a diseased organ ("a bum ticker"). By contrast, the patient with pancreatic cancer has a completely altered self-image and is viewed differently by family and anyone who knows the diagnosis. He or she is being attacked and invaded by a disease that could be anywhere in the body. Every ache or pain takes on desperate significance. Cancer is an exception to the coordinated interaction among cells and organs. In general, the cells of a multicellular organism are programmed for collaboration. Many diseases occur because the specialized cells fail to

perform their assigned task. Cancer takes this malfunction one step further. Not only is there a failure of the cancer cell to maintain its specialized function, but it also strikes out on its own; the cancer cell competes to survive using natural mutability and natural selection to seek advantage over normal cells in a recapitulation of evolution. One consequence of the traitorous behavior of cancer cells is that patients feel betrayed by their body. Cancer patients feel that they, and not just a body part, are diseased.

### THE MAGNITUDE OF THE PROBLEM

No nationwide cancer registry exists; therefore, the incidence of cancer is estimated on the basis of the National Cancer Institute's Surveillance, Epidemiology, and End Results (SEER) database, which tabulates cancer incidence and death figures from nine sites, accounting for ~10% of the U.S. population, and from population data from the U.S. Census Bureau. In 2007, 1.445 million new cases of invasive cancer (766,860 men, 678,060 women) were diagnosed and 559,650 persons (289,550 men, 270,100 women) died from cancer. The percent distribution of new cancer cases and cancer deaths by site for men and

women are shown in [Table 25-1](#). Cancer incidence has been declining by ~2% each year since 1992.

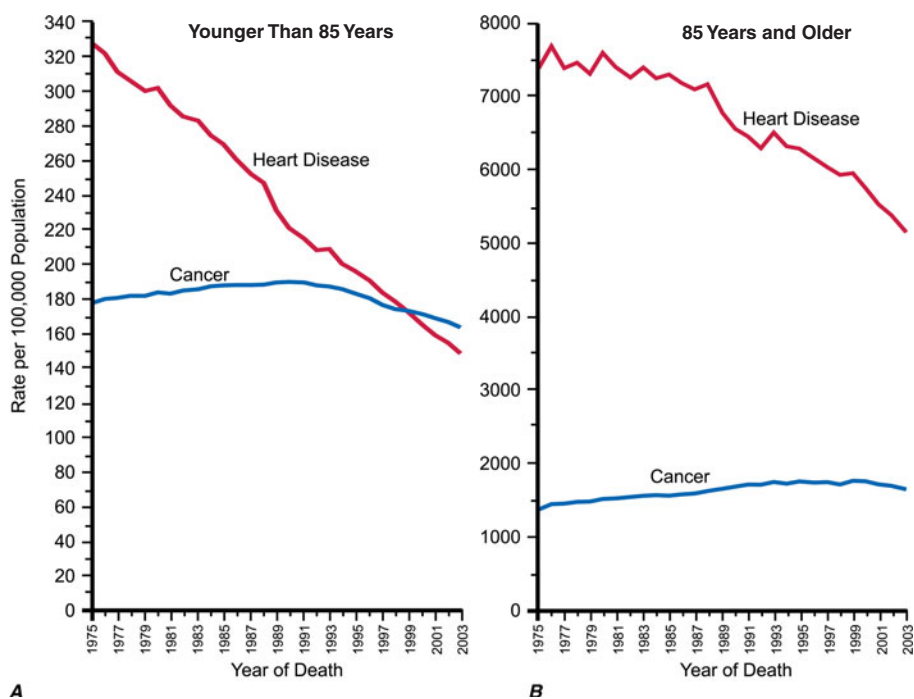
The most significant risk factor for cancer overall is age; two-thirds of all cases were in those >65 years of age. Cancer incidence increases as the third, fourth, or fifth power of age in different sites. For the interval between birth and age 39, 1 in 72 men and 1 in 51 women will develop cancer; for the interval between ages 40 and 59, 1 in 12 men and 1 in 11 women will develop cancer; and for the interval between ages 60 and 79, 1 in 3 men and 1 in 5 women will develop cancer. Overall, men have a 45% risk of developing cancer at some time during their lives; women have a 37% lifetime risk.

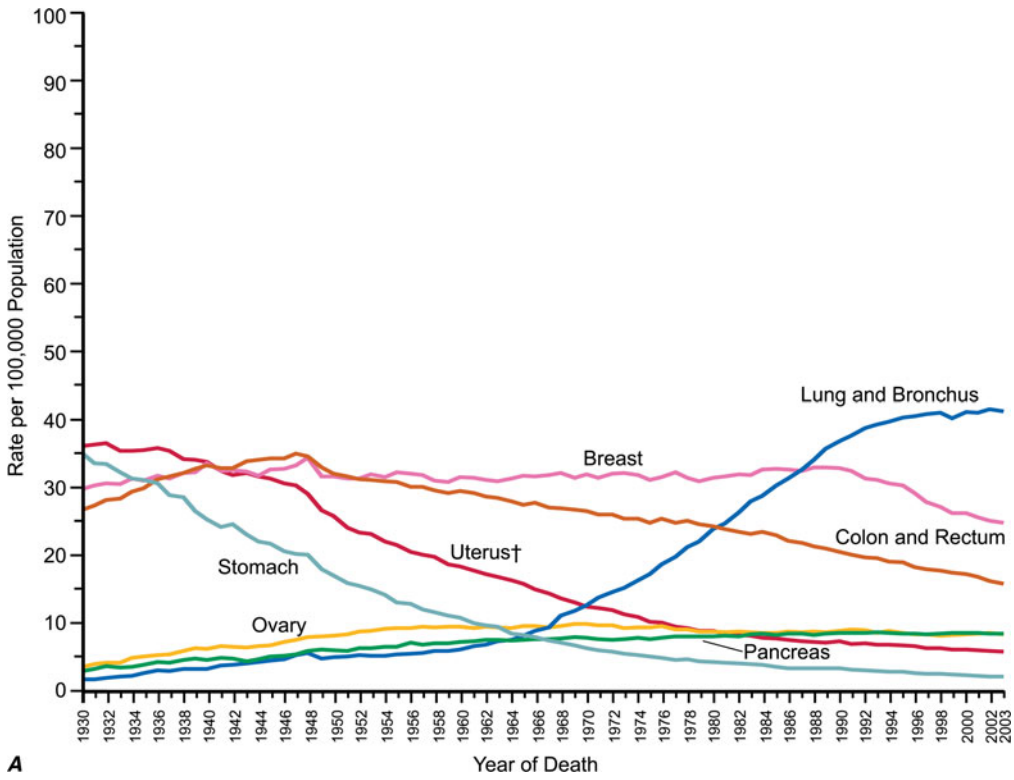
Cancer is the second leading cause of death behind heart disease. Deaths from heart disease have declined 45% in the United States since 1950 and continue to decline. Cancer has overtaken heart disease as the number-one cause of death in persons <85 years of age ([Fig. 25-1](#)). After a 70-year period of increases, cancer deaths began to decline in 1997 ([Fig. 25-2](#)). The five leading causes of cancer deaths are shown for various populations in [Table 25-2](#). Along with the decrease in incidence has come an increase in survival for cancer patients. The 5-year survival for white patients was 39% in 1960–1963 and 68% in 1996–2002. Cancers are more often deadly in blacks; the 5-year survival was 57% for the 1996–2002 interval. Incidence and mortality vary among racial and ethnic groups ([Table 25-3](#)). The basis for these differences is unclear.

**TABLE 25-1**

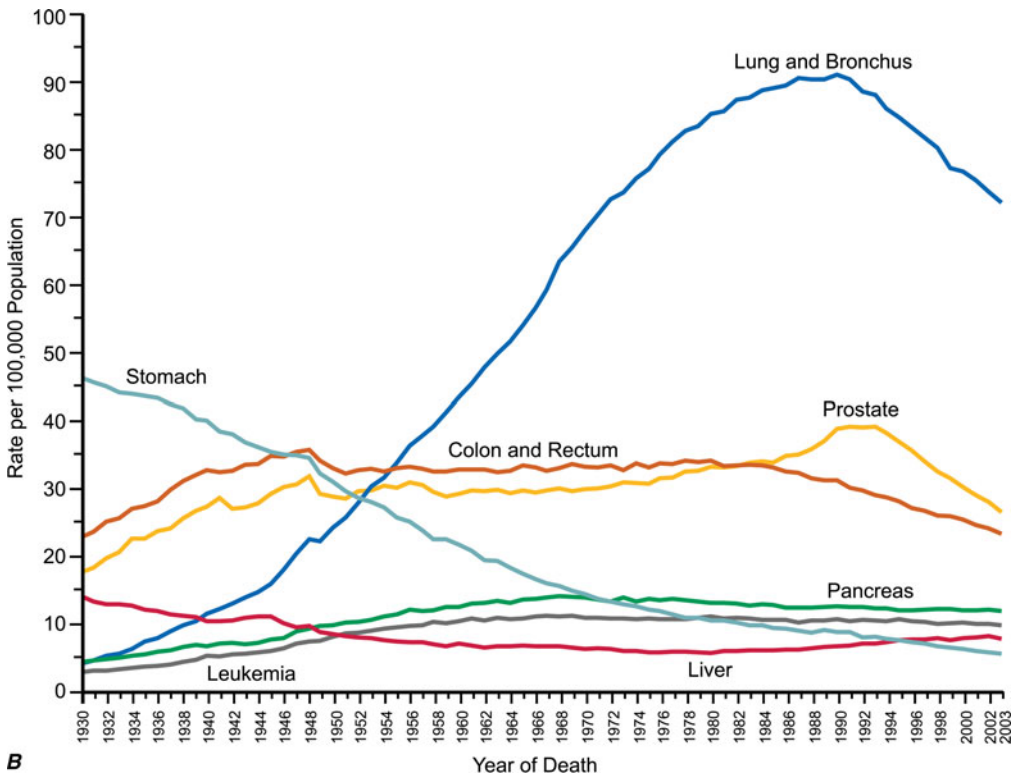
**DISTRIBUTION OF CANCER INCIDENCE AND DEATHS FOR 2007**

MALE			FEMALE		
SITES	%	NUMBER	SITES	%	NUMBER
<b>Cancer Incidence</b>					
Prostate	29	218,890	Breast	26	178,480
Lung	15	114,760	Lung	15	98,620
Colorectal	10	79,130	Colorectal	11	74,630
Bladder	7	50,040	Endometrial	6	39,080
Lymphoma	4	34,200	Lymphoma	4	28,990
Melanoma	4	33,910	Melanoma	4	26,030
Kidney	4	31,590	Thyroid	4	25,480
Leukemia	3	24,800	Ovary	3	22,430
Oral cavity	3	24,180	Kidney	3	19,600
Pancreas	2	18,830	Leukemia	3	19,440
All others	18	136,530	All others	21	145,280
All sites	100	776,860	All sites	100	678,060
<b>Cancer Deaths</b>					
Lung	31	89,510	Lung	26	70,880
Prostate	9	27,050	Breast	15	40,460
Colorectal	9	26,000	Colorectal	10	26,180
Pancreas	6	16,840	Pancreas	6	16,530
Leukemia	4	12,320	Ovary	6	15,280
Liver	4	11,280	Leukemia	4	9,470
Esophagus	4	10,900	Lymphoma	3	9,060
Bladder	3	9,630	Endometrial	3	7,400
Lymphoma	3	9,600	CNS	2	5,590
Kidney	3	8,080	Liver	2	5,500
All others	24	68,340	All others	23	63,750
All sites	100	289,550	All sites	100	270,100





A



B

**FIGURE 25-2** Sixty-year trend in cancer death rates for (A) women and (B) men, by site in the United States, 1930–2003. Rates are per 100,000 age-adjusted to the 2000 U.S. standard population. (From Jemal et al.)

TABLE 25-2

## THE FIVE LEADING PRIMARY TUMOR SITES FOR PATIENTS DYING OF CANCER BASED ON AGE AND SEX IN 2004

RANK		ALL AGES	AGE, YEARS				
			UNDER 20	20-39	40-59	60-79	>80
1	M	Lung	Leukemia	Leukemia	Lung	Lung	Lung
	F	Lung	Leukemia	Breast	Breast	Lung	Lung
2	M	Prostate	CNS	CNS	Colorectal	Colorectal	Prostate
	F	Breast	CNS	Cervix	Lung	Breast	Colorectal
3	M	Colorectal	Bone sarcoma	Colorectal	Pancreas	Prostate	Colorectal
	F	Colorectal	Endocrine	Leukemia	Colorectal	Colorectal	Breast
4	M	Pancreas	Endocrine	Lymphoma	Liver	Pancreas	Bladder
	F	Pancreas	Soft tissue sarcoma	Colorectal	Ovary	Pancreas	Pancreas
5	M	Leukemia	Soft tissue sarcoma	Lung	Esophagus	Leukemia	Pancreas
	F	Ovary	Bone sarcoma	CNS	Pancreas	Ovary	Lymphoma

Note: M, male; F, female.

## CANCER AROUND THE WORLD



In 2002, 11 million new cancer cases and 7 million cancer deaths were estimated worldwide. When broken down by region of the world, ~45% of cases were in Asia, 26% in Europe, 14.5% in North America,

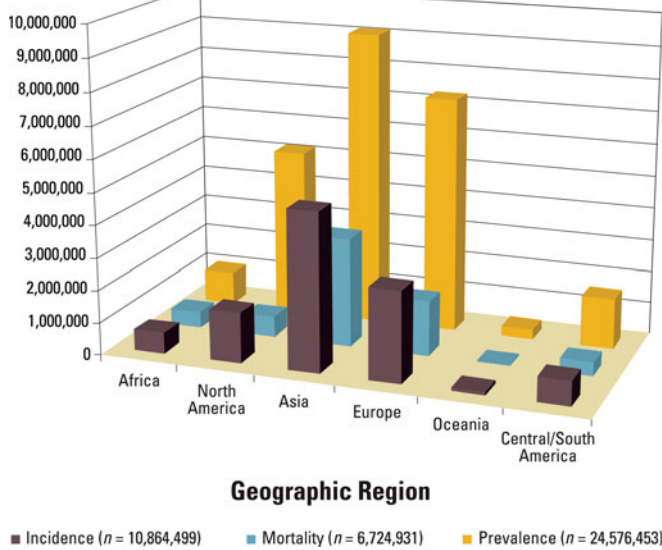
7.1% in Central/South America, 6% in Africa, and 1% in Australia/New Zealand (Fig. 25-3). Lung cancer is the most common cancer and the most common cause of cancer death in the world. Its incidence is highly variable, affecting only 2 per 100,000 African women but as many as 61 per 100,000 North American men. Breast

TABLE 25-3

## CANCER INCIDENCE AND MORTALITY IN RACIAL AND ETHNIC GROUPS, U.S., 1999-2003

SITE		WHITE	BLACK	ASIAN/PACIFIC ISLANDER	AMERICAN INDIAN	HISPANIC
<b>Incidence per 100,000 Population</b>						
All	M	555	639.8	385.5	359.9	444.1
	F	421.1	383.8	303.3	305	327.2
Breast		130.8	111.5	91.2	74.4	92.6
Colorectal	M	63.7	70.2	52.6	52.7	52.4
	F	45.9	53.5	38.0	41.9	37.3
Kidney	M	18	18.5	9.8	20.9	16.9
	F	9.3	9.5	4.9	10	9.4
Liver	M	7.2	11.1	22.1	14.5	14.8
	F	2.7	3.6	8.3	6.5	5.8
Lung	M	88.8	110.6	56.6	55.5	52.7
	F	56.2	50.3	28.7	33.8	26.7
Prostate		156	243	104	70.7	141.1
<b>Deaths per 100,000 Population</b>						
All	M	239.2	331	144.9	153.4	166.4
	F	163.4	192.4	98.8	111.6	108.8
Breast		25.4	34.4	12.6	13.8	16.3
Colorectal	M	23.7	33.6	15.3	15.9	17.5
	F	16.4	23.7	10.5	11.1	11.4
Kidney	M	6.2	6.1	2.6	6.8	5.5
	F	2.8	2.8	1.2	3.3	2.4
Liver	M	6.3	9.6	15.5	7.8	10.7
	F	2.8	3.8	6.7	4	5
Lung	M	73.8	98.4	38.8	42.9	37.2
	F	42	39.8	18.8	27	14.7
Prostate		26.7	65.1	11.8	18	22.1

Note: M, male; F, female.

**FIGURE 25-3**

**Worldwide overall annual cancer incidence, mortality and 5-year prevalence for the period 1993 to 2001. (From Kamangar et al.)**

cancer is the second most common cancer worldwide; however, it ranks fifth as a cause of death behind lung, stomach, liver, and colorectal cancer. Among the eight most common forms of cancer, lung (2-fold), breast (3-fold), prostate (2.5-fold), and colorectal (3-fold) cancers are more common in more developed countries than in less developed countries. By contrast, liver (2-fold), cervical (2-fold), and esophageal (2- to 3-fold) cancers are more common in less developed countries. Stomach cancer incidence is similar in more and less developed countries but is much more common in Asia than North America or Africa. The most common cancers in Africa are cervical, breast, and liver cancers. It has been estimated that nine modifiable risk factors are responsible for more than a third of cancers worldwide. These include smoking, alcohol consumption, obesity, physical inactivity, low fruit and vegetable consumption, unsafe sex, air pollution, indoor smoke from household fuels, and contaminated injections.

## PATIENT MANAGEMENT

Important information is obtained from every portion of the routine history and physical examination. The duration of symptoms may reveal the chronicity of disease. The past medical history may alert the physician to the presence of underlying diseases that may affect the choice of therapy or the side effects of treatment. The social history may reveal occupational exposure to carcinogens or habits such as smoking or alcohol consumption that may influence the course of disease and its treatment. The family history may suggest an underlying

familial cancer predisposition and point out the need to begin surveillance or other preventive therapy for unaffected siblings of the patient. The review of systems may suggest early symptoms of metastatic disease or a paraneoplastic syndrome.

## DIAGNOSIS

The diagnosis of cancer relies most heavily on invasive tissue biopsy and should never be made without obtaining tissue; no noninvasive diagnostic test is sufficient to define a disease process as cancer. Although in rare clinical settings (e.g., thyroid nodules) fine-needle aspiration is an acceptable diagnostic procedure, the diagnosis generally depends on obtaining adequate tissue to permit careful evaluation of the histology of the tumor, its grade, and its invasiveness and to yield further molecular diagnostic information, such as the expression of cell-surface markers or intracellular proteins that typify a particular cancer, or the presence of a molecular marker, such as the t(8;14) translocation of Burkitt's lymphoma. Increasing evidence links the expression of certain genes with the prognosis and response to therapy (Chaps. 23, 24).

Occasionally a patient presents with a metastatic disease process that is defined as cancer on biopsy but has no apparent primary site of disease. Efforts should be made to define the primary site based on age, sex, sites of involvement, histology and tumor markers, and personal and family history. Particular attention should be focused on ruling out the most treatable causes (Chap. 44).

Once the diagnosis of cancer is made, the management of the patient is best undertaken as a multidisciplinary collaboration among the primary care physician, medical oncologists, surgical oncologists, radiation oncologists, oncology nurse specialists, pharmacists, social workers, rehabilitation medicine specialists, and a number of other consulting professionals working closely with each other and with the patient and family.

## DEFINING THE EXTENT OF DISEASE AND THE PROGNOSIS

The first priority in patient management after the diagnosis of cancer is established and shared with the patient is to determine the extent of disease. The curability of a tumor usually is inversely proportional to the tumor burden. Ideally, the tumor will be diagnosed before symptoms develop or as a consequence of screening efforts (Chap. 26). A very high proportion of such patients can be cured. However, most patients with cancer present with symptoms related to the cancer, caused either by mass effects of the tumor or by alterations associated with the production of cytokines or hormones by the tumor.

For most cancers, the extent of disease is evaluated by a variety of noninvasive and invasive diagnostic tests and

procedures. This process is called *staging*. There are two types. *Clinical staging* is based on physical examination, radiographs, isotopic scans, CT scans, and other imaging procedures; *pathologic staging* takes into account information obtained during a surgical procedure, which might include intraoperative palpation, resection of regional lymph nodes and/or tissue adjacent to the tumor, and inspection and biopsy of organs commonly involved in disease spread. Pathologic staging includes histologic examination of all tissues removed during the surgical procedure. Surgical procedures performed may include a simple lymph node biopsy or more extensive procedures such as thoracotomy, mediastinoscopy, or laparotomy. Surgical staging may occur in a separate procedure or may be done at the time of definitive surgical resection of the primary tumor.

Knowledge of the predilection of particular tumors for spread to adjacent or distant organs helps direct the staging evaluation.

Information obtained from staging is used to define the extent of disease either as localized, as exhibiting spread outside of the organ of origin to regional but not distant sites, or as metastatic to distant sites. The most widely used system of staging is the TNM (tumor, node, metastasis) system codified by the International Union Against Cancer and the American Joint Committee on Cancer (AJCC). The TNM classification is an anatomically based system that categorizes the tumor on the basis of the size of the primary tumor lesion (T1–4, where a higher number indicates a tumor of larger size), the presence of nodal involvement (usually N0 and N1 for the absence and presence, respectively, of involved nodes, although some tumors have more elaborate systems of nodal grading), and the presence of metastatic disease (M0 and M1 for the absence and presence, respectively, of metastases). The various permutations of T, N, and M scores (sometimes including tumor histologic grade G) are then broken into stages, usually designated by the roman numerals I through IV. Tumor burden increases and curability decreases with increasing stage. Other anatomic staging systems are used for some tumors, e.g., the Dukes classification for colorectal cancers, the International Federation of Gynecologists and Obstetricians (FIGO) classification for gynecologic cancers, and the Ann Arbor classification for Hodgkin's disease.<sup>1</sup>

Certain tumors cannot be grouped on the basis of anatomic considerations. For example, hematopoietic tumors such as leukemia, myeloma, and lymphoma are often disseminated at presentation and do not spread like solid tumors. For these tumors, other prognostic factors have been identified (Chaps. 14–16).

In addition to tumor burden, a second major determinant of treatment outcome is the physiologic reserve of the patient. Patients who are bedridden before developing cancer are likely to fare worse, stage for stage, than fully active patients. Physiologic reserve is a determinant of how a patient is likely to cope with the physiologic stresses imposed by the cancer and its treatment. This factor is difficult to assess directly. Instead, surrogate markers for physiologic reserve are used, such as the patient's age or Karnofsky performance status (Table 25-4). Older patients and those with a Karnofsky performance status <70 have a poor prognosis unless the poor performance is a reversible consequence of the tumor.

Increasingly, biologic features of the tumor are being related to prognosis. The expression of particular oncogenes, drug-resistance genes, apoptosis-related genes, and genes involved in metastasis are being found to influence response to therapy and prognosis. The presence of selected cytogenetic abnormalities may influence survival. Tumors with higher growth fractions, as assessed by expression of proliferation-related markers such as proliferating cell nuclear antigen (PCNA), behave more aggressively than tumors with lower growth fractions. Information obtained from studying the tumor itself will increasingly be used to influence treatment decisions. Host genes involved in drug metabolism can influence the safety and efficacy of particular treatments.

**TABLE 25-4**

**KARNOFSKY PERFORMANCE INDEX**

PERFORMANCE STATUS	FUNCTIONAL CAPABILITY OF THE PATIENT
100	Normal; no complaints; no evidence of disease
90	Able to carry on normal activity; minor signs or symptoms of disease
80	Normal activity with effort; some signs or symptoms of disease
70	Cares for self; unable to carry on normal activity or do active work
60	Requires occasional assistance but is able to care for most needs
50	Requires considerable assistance and frequent medical care
40	Disabled; requires special care and assistance
30	Severely disabled; hospitalization is indicated although death is not imminent
20	Very sick; hospitalization necessary; active supportive treatment is necessary
10	Moribund, fatal processes progressing rapidly
0	Dead

<sup>1</sup>The AJCC *Manual for Staging Cancer*, 5th edition, can be obtained from the AJCC at 55 East Erie Street, Chicago, IL 60611.

From information on the extent of disease and the prognosis and in conjunction with the patient's wishes, it is determined whether the treatment approach should be curative or palliative in intent. Cooperation among the various professionals involved in cancer treatment is of the utmost importance in treatment planning. For some cancers, chemotherapy or chemotherapy plus radiation therapy delivered before the use of definitive surgical treatment (so-called neoadjuvant therapy) may improve the outcome, as seems to be the case for locally advanced breast cancer and head and neck cancers. In certain settings in which combined modality therapy is intended, coordination among the medical oncologist, radiation oncologist, and surgeon is crucial to achieving optimal results. Sometimes the chemotherapy and radiation therapy need to be delivered sequentially, and other times concurrently. Surgical procedures may precede or follow other treatment approaches. It is best for the treatment plan either to follow a standard protocol precisely or else to be part of an ongoing clinical research protocol evaluating new treatments. Ad hoc modifications of standard protocols are likely to compromise treatment results.

The choice of treatment approaches was formerly dominated by the local culture in both the university and the practice settings. However, it is now possible to gain access electronically to standard treatment protocols and to every approved clinical research study in North America through a personal computer interface with the Internet.<sup>2</sup>

The skilled physician also has much to offer the patient for whom curative therapy is no longer an option. Often a combination of guilt and frustration over the inability to cure the patient and the pressure of a busy schedule greatly limit the time a physician spends with a patient who is receiving only palliative care. Resist these forces. In addition to the medicines administered to alleviate symptoms (see later), it is important to remember the comfort that is provided by holding the patient's hand, continuing regular examinations, and taking time to talk.

## **MANAGEMENT OF DISEASE AND TREATMENT COMPLICATIONS**

Because cancer therapies are toxic (Chap. 27), patient management involves addressing complications of both the disease and its treatment as well as the complex

psychosocial problems associated with cancer. In the short term during a course of curative therapy, the patient's functional status may decline. Treatment-induced toxicity is less acceptable if the goal of therapy is palliation. The most common side effects of treatment are nausea and vomiting (see later), febrile neutropenia (Chap. 28), and myelosuppression (Chap. 27). Tools are now available to minimize the acute toxicity of cancer treatment.

New symptoms developing in the course of cancer treatment should always be assumed to be reversible until proven otherwise. The fatalistic attribution of anorexia, weight loss, and jaundice to recurrent or progressive tumor could result in a patient dying from a reversible intercurrent cholecystitis. Intestinal obstruction may be due to reversible adhesions rather than progressive tumor. Systemic infections, sometimes with unusual pathogens, may be a consequence of the immunosuppression associated with cancer therapy. Some drugs used to treat cancer or its complications (e.g., nausea) may produce central nervous system symptoms that look like metastatic disease or may mimic paraneoplastic syndromes such as the syndrome of inappropriate antidiuretic hormone. A definitive diagnosis should be pursued and may even require a repeat biopsy.

A critical component of cancer management is assessing the response to treatment. In addition to a careful physical examination in which all sites of disease are physically measured and recorded in a flow chart by date, response assessment usually requires periodic repeating of imaging tests that were abnormal at the time of staging. If imaging tests have become normal, repeat biopsy of previously involved tissue is performed to document complete response by pathologic criteria. Biopsies are not usually required if there is macroscopic residual disease. A *complete response* is defined as disappearance of all evidence of disease, and a *partial response* is defined as >50% reduction in the sum of the products of the perpendicular diameters of all measurable lesions. The determination of partial response may also be based on a 30% decrease in the sums of the longest diameters of lesions (Response Evaluation Criteria in Solid Tumors, or RECIST, criteria). *Progressive disease* is defined as the appearance of any new lesion or an increase of >25% in the sum of the products of the perpendicular diameters of all measurable lesions (or an increase of 20% in the sums of the longest diameters by RECIST). Tumor shrinkage or growth that does not meet any of these criteria is considered *stable disease*. Some sites of involvement (e.g., bone) or patterns of involvement (e.g., lymphangitic lung or diffuse pulmonary infiltrates) are considered unmeasurable. No response is complete without biopsy documentation of their resolution, but partial responses may exclude their assessment unless clear objective progression has occurred.

Tumor markers may be useful in patient management in certain tumors. Response to therapy may be difficult to gauge with certainty. However, some tumors produce

<sup>2</sup>The National Cancer Institute maintains a database called PDQ (Physician Data Query) that is accessible on the Internet under the name CancerNet at [www.wicic.nci.nih.gov/health.htm](http://www.wicic.nci.nih.gov/health.htm). Information can be obtained through a facsimile machine using CancerFax by dialing 301-402-5874. Patient information is also provided by the National Cancer Institute in at least three formats: on the Internet via CancerNet at [www.wicic.nci.nih.gov/patient.htm](http://www.wicic.nci.nih.gov/patient.htm), through the CancerFax number just listed above, or by calling 1-800-4-CANCER. The quality control for the information provided through these services is rigorous.

or elicit the production of markers that can be measured in the serum or urine and, in a particular patient, rising and falling levels of the marker are usually associated with increasing or decreasing tumor burden, respectively. Some clinically useful tumor markers are shown in **Table 25-5**. Tumor markers are not in themselves specific enough to permit a diagnosis of malignancy to be made, but once a malignancy has been diagnosed and shown to be associated with elevated levels of a tumor marker, the marker can be used to assess response to treatment.

The recognition and treatment of depression are important components of management. The incidence of depression in cancer patients is ~25% overall and may

be greater in patients with greater debility. This diagnosis is likely in a patient with a depressed mood (dysphoria) and/or a loss of interest in pleasure (anhedonia) for at least 2 weeks. In addition, three or more of the following symptoms are usually present: appetite change, sleep problems, psychomotor retardation or agitation, fatigue, feelings of guilt or worthlessness, inability to concentrate, and suicidal ideation. Patients with these symptoms should receive therapy. Medical therapy with a serotonin reuptake inhibitor such as fluoxetine (10–20 mg/d), sertraline (50–150 mg/d), or paroxetine (10–20 mg/d) or a tricyclic antidepressant such as amitriptyline (50–100 mg/d) or desipramine (75–150 mg/d) should be tried, allowing 4–6 weeks for response. Effective therapy should be

**TABLE 25-5****TUMOR MARKERS**

TUMOR MARKERS	CANCER	NON-NEOPLASTIC CONDITIONS
<b>Hormones</b>		
Human chorionic gonadotropin	Gestational trophoblastic disease, gonadal germ cell tumor	Pregnancy
Calcitonin	Medullary cancer of the thyroid	
Catecholamines	Pheochromocytoma	
<b>Oncofetal Antigens</b>		
Alpha fetoprotein	Hepatocellular carcinoma, gonadal germ cell tumor	Cirrhosis, hepatitis
Carcinoembryonic antigen	Adenocarcinomas of the colon, pancreas, lung, breast, ovary	Pancreatitis, hepatitis, inflammatory bowel disease, smoking
<b>Enzymes</b>		
Prostatic acid phosphatase	Prostate cancer	Prostatitis, prostatic hypertrophy
Neuron-specific enolase	Small cell cancer of the lung, neuroblastoma	
Lactate dehydrogenase	Lymphoma, Ewing's sarcoma	Hepatitis, hemolytic anemia, many others
<b>Tumor-Associated Proteins</b>		
Prostate-specific antigen	Prostate cancer	Prostatitis, prostatic hypertrophy
Monoclonal immunoglobulin	Myeloma	Infection, MGUS
CA-125	Ovarian cancer, some lymphomas	Menstruation, peritonitis, pregnancy
CA 19-9	Colon, pancreatic, breast cancer	Pancreatitis, ulcerative colitis
CD30	Hodgkin's disease, anaplastic large cell lymphoma	—
CD25	Hairy cell leukemia, adult T cell leukemia/lymphoma	—

**Note:** MGUS, monoclonal gammopathy of uncertain significance.



328 continued at least 6 months after resolution of symptoms. If therapy is unsuccessful, other classes of antidepressants may be used. In addition to medication, psychosocial interventions such as support groups, psychotherapy, and guided imagery may be of benefit.

Many patients opt for unproven or unsound approaches to treatment when it appears that conventional medicine is unlikely to be curative. Those seeking such alternatives are often well educated and may be early in the course of their disease. Unsound approaches are usually hawked on the basis of unsubstantiated anecdotes and not only cannot help the patient but may be harmful. Physicians should strive to keep communications open and nonjudgmental, so that patients are more likely to discuss with the physician what they are actually doing. The appearance of unexpected toxicity may be an indication that a supplemental therapy is being taken.<sup>3</sup>

### LONG-TERM FOLLOW-UP/LATE COMPLICATIONS

At the completion of treatment, sites originally involved with tumor are reassessed, usually by radiography or imaging techniques, and any persistent abnormality is biopsied. If disease persists, the multidisciplinary team discusses a new salvage treatment plan. If the patient has been rendered disease-free by the original treatment, the patient is followed regularly for disease recurrence. The optimal guidelines for follow-up care are not known. For many years, a routine practice has been to follow the patient monthly for 6–12 months, then every other month for a year, every 3 months for a year, every 4 months for a year, every 6 months for a year, and then annually. At each visit, a battery of laboratory and radiographic and imaging tests were obtained on the assumption that it is best to detect recurrent disease before it becomes symptomatic. However, where follow-up procedures have been examined, this assumption has been found to be untrue. Studies of breast cancer, melanoma, lung cancer, colon cancer, and lymphoma have all failed to support the notion that asymptomatic relapses are more readily cured by salvage therapy than symptomatic relapses. In view of the enormous cost of a full battery of diagnostic tests and their manifest lack of impact on survival, new guidelines are emerging for less frequent follow-up visits, during which the history and physical examination are the major investigations performed.

As time passes, the likelihood of recurrence of the primary cancer diminishes. For many types of cancer, survival for 5 years without recurrence is tantamount to cure. How-

ever, important medical problems can occur in patients treated for cancer and must be examined (Chap. 52). Some problems emerge as a consequence of the disease and some as a consequence of the treatment. An understanding of these disease- and treatment-related problems may help in their detection and management.

Despite these concerns, most patients who are cured of cancer return to normal lives.

### SUPPORTIVE CARE

In many ways, the success of cancer therapy depends on the success of the supportive care. Failure to control the symptoms of cancer and its treatment may lead patients to abandon curative therapy. Of equal importance, supportive care is a major determinant of quality of life. Even when life cannot be prolonged, the physician must strive to preserve its quality. Quality-of-life measurements have become common end points of clinical research studies. Furthermore, palliative care has been shown to be cost effective when approached in an organized fashion. A credo for oncology could be to cure sometimes, to extend life often, and to comfort always.

#### *Pain*

Pain occurs with variable frequency in the cancer patient: 25–50% of patients present with pain at diagnosis, 33% have pain associated with treatment, and 75% have pain with progressive disease. The pain may have several causes. In ~70% of cases, pain is caused by the tumor itself—by invasion of bone, nerves, blood vessels, or mucous membranes or obstruction of a hollow viscus or duct. In ~20% of cases, pain is related to a surgical or invasive medical procedure, to radiation injury (mucositis, enteritis, or plexus or spinal cord injury), or to chemotherapy injury (mucositis, peripheral neuropathy, phlebitis, steroid-induced aseptic necrosis of the femoral head). In 10% of cases, pain is unrelated to cancer or its treatment.

Assessment of pain requires the methodical investigation of the history of the pain, its location, character, temporal features, provocative and palliative factors, and intensity; a review of the oncologic history and past medical history as well as personal and social history; and a thorough physical examination. The patient should be given a 10-division visual analogue scale on which to indicate the severity of the pain. The clinical condition is often dynamic, making it necessary to reassess the patient frequently. Pain therapy should not be withheld while the cause of pain is being sought.

A variety of tools are available with which to address cancer pain. About 85% of patients obtain pain relief from pharmacologic intervention. However, other modalities, including antitumor therapy (such as surgical

<sup>3</sup>Information about unsound methods may be obtained from the National Council Against Health Fraud, Box 1276, Loma Linda, CA 92354, or from the Center for Medical Consumers and Health Care Information, 237 Thompson Street, New York, NY 10012.

relief of obstruction, radiation therapy, and strontium-89 or samarium-153 treatment for bone pain), neurostimulatory techniques, regional analgesia, or neuroablative procedures are effective in an additional 12% or so. Thus very few patients will have inadequate pain relief if appropriate measures are taken. A specific approach to pain relief is detailed in Chap. 30.

### Nausea

Emesis in the cancer patient is usually caused by chemotherapy (Chap. 27). Its severity can be predicted from the drugs used to treat the cancer. Three forms of emesis are recognized on the basis of their timing with regard to the noxious insult. *Acute emesis*, the most common variety, occurs within 24 h of treatment. *Delayed emesis* occurs 1–7 days after treatment; it is rare, but, when present, usually follows cisplatin administration. *Anticipatory emesis* occurs before administration of chemotherapy and represents a conditioned response to visual and olfactory stimuli previously associated with chemotherapy delivery.

Acute emesis is the best understood form. Stimuli that activate signals in the chemoreceptor trigger zone in the medulla, the cerebral cortex, and peripherally in the intestinal tract lead to stimulation of the vomiting center in the medulla, the motor center responsible for coordinating the secretory and muscle contraction activity that leads to emesis. Diverse receptor types participate in the process, including dopamine, serotonin, histamine, opioid, and acetylcholine receptors. The serotonin receptor antagonists ondansetron and granisetron are the most effective drugs against highly emetogenic agents, but they are expensive.

As with the analgesia ladder, emesis therapy should be tailored to the situation. For mildly and moderately emetogenic agents, prochlorperazine, 5–10 mg PO or 25 mg PR, is effective. Its efficacy may be enhanced by administering the drug before the chemotherapy is delivered. Dexamethasone, 10–20 mg IV, is also effective and may enhance the efficacy of prochlorperazine. For highly emetogenic agents such as cisplatin, mechlorethamine, dacarbazine, and streptozocin, combinations of agents work best and administration should begin 6–24 h before treatment. Ondansetron, 8 mg PO every 6 h the day before therapy and IV on the day of therapy, plus dexamethasone, 20 mg IV before treatment, is an effective regimen. Addition of oral aprepitant (a substance P/neurokinin 1 receptor antagonist) to this regimen (125 mg on day 1, 80 mg on days 2 and 3) further decreases the risk of both acute and delayed vomiting. Like pain, emesis is easier to prevent than to alleviate.

Delayed emesis may be related to bowel inflammation from the therapy and can be controlled with oral dexamethasone and oral metoclopramide, a dopamine receptor antagonist that also blocks serotonin receptors

at high dosages. The best strategy for preventing anticipatory emesis is to control emesis in the early cycles of therapy to prevent the conditioning from taking place. If this is unsuccessful, prophylactic antiemetics the day before treatment may help. Experimental studies are evaluating behavior modification.

### Effusions

Fluid may accumulate abnormally in the pleural cavity, pericardium, or peritoneum. Asymptomatic malignant effusions may not require treatment. Symptomatic effusions occurring in tumors responsive to systemic therapy usually do not require local treatment but respond to the treatment for the underlying tumor. Symptomatic effusions occurring in tumors unresponsive to systemic therapy may require local treatment in patients with a life expectancy of at least 6 months.

Pleural effusions due to tumors may or may not contain malignant cells. Lung cancer, breast cancer, and lymphomas account for ~75% of malignant pleural effusions. Their exudative nature is usually gauged by an effusion/serum protein ratio of  $\geq 0.5$  or an effusion/serum lactate dehydrogenase ratio of  $\geq 0.6$ . When the condition is symptomatic, thoracentesis is usually performed first. In most cases, symptomatic improvement occurs for <1 month. Chest tube drainage is required if symptoms recur within 2 weeks. Fluid is aspirated until the flow rate is <100 mL in 24 h. Then either 60 units of bleomycin or 1 g of doxycycline is infused into the chest tube in 50 mL of 5% dextrose in water; the tube is clamped; the patient is rotated on four sides, spending 15 min in each position; and, after 1–2 h, the tube is again attached to suction for another 24 h. The tube is then disconnected from suction and allowed to drain by gravity. If <100 mL drains over the next 24 h, the chest tube is pulled, and a radiograph taken 24 h later. If the chest tube continues to drain fluid at an unacceptably high rate, sclerosis can be repeated. Bleomycin may be somewhat more effective than doxycycline but is very expensive. Doxycycline is usually the drug of first choice. If neither doxycycline nor bleomycin is effective, talc can be used.

Symptomatic pericardial effusions are usually treated by creating a pericardial window or by stripping the pericardium. If the patient's condition does not permit a surgical procedure, sclerosis can be attempted with doxycycline and/or bleomycin.

Malignant ascites is usually treated with repeated paracentesis of small volumes of fluid. If the underlying malignancy is unresponsive to systemic therapy, peritoneovenous shunts may be inserted. Despite the fear of disseminating tumor cells into the circulation, widespread metastases are an unusual complication. The major complications are occlusion, leakage, and fluid overload. Patients with severe liver disease may develop disseminated intravascular coagulation.

Cancer and its treatment may lead to a decrease in nutrient intake of sufficient magnitude to cause weight loss and alteration of intermediary metabolism. The prevalence of this problem is difficult to estimate because of variations in the definition of cancer cachexia, but most patients with advanced cancer experience weight loss and decreased appetite. A variety of both tumor-derived factors (e.g., bombesin, adrenocorticotropic hormone) and host-derived factors (e.g., tumor necrosis factor, interleukins 1 and 6, growth hormone) contribute to the altered metabolism, and a vicious cycle is established in which protein catabolism, glucose intolerance, and lipolysis cannot be reversed by the provision of calories.

It remains controversial how to assess nutritional status and when and how to intervene. Efforts to make the assessment objective have included the use of a prognostic nutritional index based on albumin levels, triceps skin fold thickness, transferrin levels, and delayed-type hypersensitivity skin testing. However, a simpler approach has been to define the threshold for nutritional intervention as >10% unexplained body weight loss, serum transferrin level <1500 mg/L (150 mg/dL), and serum albumin <34 g/L (3.4 g/dL).

The decision is important because it appears that cancer therapy is substantially more toxic and less effective in the face of malnutrition. Nevertheless, it remains unclear whether nutritional intervention can alter the natural history. Unless some pathology is affecting the absorptive function of the gastrointestinal tract, enteral nutrition provided orally or by tube feeding is preferred over parenteral supplementation. However, the risks associated with the tube may outweigh the benefits. Megestrol acetate, a progestational agent, has been advocated as a pharmacologic intervention to improve nutritional status. Research in this area may provide more tools in the future as cytokine-mediated mechanisms are further elucidated.

### **Psychosocial Support**

The psychosocial needs of patients vary with their situation. Patients undergoing treatment experience fear, anxiety, and depression. Self-image is often seriously compromised by deforming surgery and loss of hair. Women who receive cosmetic advice that enables them to look better also feel better. Loss of control over how one spends time can contribute to the sense of vulnerability. Juggling the demands of work and family with the demands of treatment may create enormous stresses. Sexual dysfunction is highly prevalent and needs to be discussed openly with the patient. An empathetic health care team is sensitive to the individual patient's needs and permits negotiation where such flexibility will not adversely affect the course of treatment.

Cancer survivors have other sets of difficulties. Patients may have fears associated with the termination of a treatment they associate with their continued survival. Adjustments are required to physical losses and handicaps, real and perceived. Patients may be preoccupied with minor physical problems. They perceive a decline in their job mobility and view themselves as less desirable workers. They may be victims of job and/or insurance discrimination. Patients may experience difficulty reentering their normal past life. They may feel guilty for having survived and may carry a sense of vulnerability to colds and other illnesses. Perhaps the most pervasive and threatening concern is the ever-present fear of relapse (the Damocles syndrome).

Patients in whom therapy has been unsuccessful have other problems related to the end of life.

### **Death and Dying**

The most common causes of death in patients with cancer are infection (leading to circulatory failure), respiratory failure, hepatic failure, and renal failure. Intestinal blockage may lead to inanition and starvation. Central nervous system disease may lead to seizures, coma, and central hypoventilation. About 70% of patients develop dyspnea preterminally. However, many months usually pass between the diagnosis of cancer and the occurrence of these complications, and during this period the patient is severely affected by the possibility of death. The path of unsuccessful cancer treatment usually occurs in three phases. First, there is optimism at the hope of cure; when the tumor recurs, there is the acknowledgment of an incurable disease, and the goal of palliative therapy is embraced in the hope of being able to live with disease; finally, at the disclosure of imminent death, another adjustment in outlook takes place. The patient imagines the worst in preparation for the end of life and may go through stages of adjustment to the diagnosis. These stages include denial, isolation, anger, bargaining, depression, acceptance, and hope. Of course, patients do not all progress through all the stages or proceed through them in the same order or at the same rate. Nevertheless, developing an understanding of how the patient has been affected by the diagnosis and is coping with it is an important goal of patient management.

It is best to speak frankly with the patient and the family regarding the likely course of disease. These discussions can be difficult for the physician as well as for the patient and family. The critical features of the interaction are to reassure the patient and family that everything that can be done to provide comfort will be done. They will not be abandoned. Many patients prefer to be cared for in their homes or in a hospice setting rather than a hospital. The American College of Physicians has published a book called *Home Care Guide for Cancer: How to Care for Family and Friends at Home* that teaches an approach to successful

problem-solving in home care. With appropriate planning, it should be possible to provide the patient with the necessary medical care as well as the psychological and spiritual support that will prevent the isolation and depersonalization that can attend in-hospital death.

The care of dying patients may take a toll on the physician. A “burnout” syndrome has been described that is characterized by fatigue, disengagement from patients and colleagues, and a loss of self-fulfillment. Efforts at stress reduction, maintenance of a balanced life, and setting realistic goals may combat this disorder.

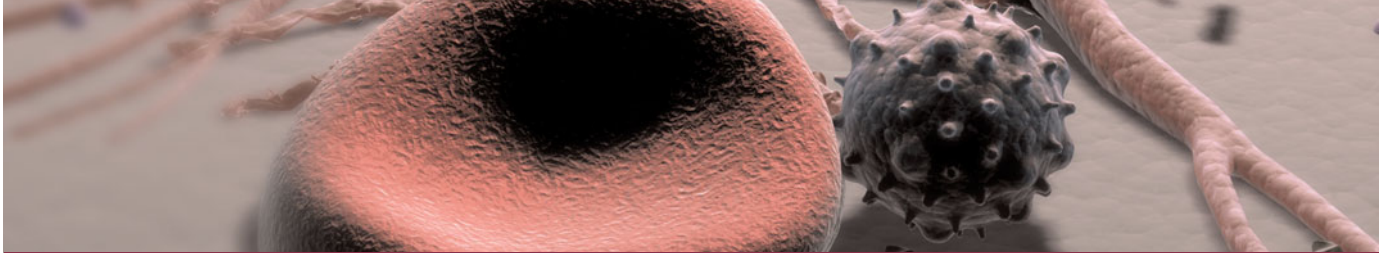
### **End-of-Life Decisions**

Unfortunately, a smooth transition in treatment goals from curative to palliative may not be possible in all cases because of the occurrence of serious treatment-related complications or rapid disease progression. Vigorous and invasive medical support for a reversible disease or treatment complication is assumed to be justified. However, if the reversibility of the condition is in doubt, the patient’s wishes determine the level of medical care. These wishes should be elicited before the terminal phase of illness and reviewed periodically. Information about advance directives can be obtained from the American Association of Retired Persons, 601 E Street, NW, Washington, DC 20049, 202-434-2277 or Choice

in Dying, 250 West 57th Street, New York, NY 10107, 212-366-5540. A full discussion of end-of-life management is in Chap. 30.

### **FURTHER READINGS**

- GRUNBERG SM, HESKETH PJ: Control of chemotherapy-induced emesis. *N Engl J Med* 329:1790, 1993
- JEMAL A et al: Cancer statistics, 2007. *CA Cancer J Clin* 57:43, 2007
- KAMANGAR F et al: Patterns of cancer incidence, mortality, and prevalence across five continents: Defining priorities to reduce cancer disparities in different geographic regions of the world. *J Clin Oncol* 24:2137, 2006
- KUCHINSKI AM et al: Treatment-related fatigue and exercise in patients with cancer: A systematic review. *Medsurg Nurs* 18:174, 2009
- LEVY MH: Pharmacologic treatment of cancer pain. *N Engl J Med* 335:1124, 1996
- MADEDDU C, MANTOVANI G: An update on promising agents for the treatment of cancer cachexia. *Curr Opin Support Palliat Care* 3:258, 2009; August 6 (Epub ahead of print)
- THERASSE P et al: New guidelines to evaluate response to treatment in solid tumors. *J Natl Cancer Inst* 92:205, 2000
- U.S. DEPARTMENT OF HEALTH AND HUMAN SERVICES: *Clinical Practice Guideline Number 9, Management of Cancer Pain*. U.S. Department of Health and Human Services, Agency for Health Care Policy and Research publication no. 94-0592, 1994
- WALSH D et al: The symptoms of advanced cancer: Relationship to age, gender, and performance status in 1000 patients. *Support Care Cancer* 8:175, 2000



## CHAPTER 26

# PREVENTION AND EARLY DETECTION OF CANCER

Otis Webb Brawley ■ Barnett S. Kramer

■ Education and Healthful Habits .....	332
■ Cancer Chemoprevention .....	334
■ Surgical Prevention of Cancer .....	337
Cancer Screening .....	337
■ Further Readings .....	341

Improved understanding of carcinogenesis has allowed cancer prevention and early detection (also known as cancer control) to expand beyond the identification and avoidance of carcinogens. Specific interventions to prevent cancer in those at risk, and more sensitive and specific screening for early detection of cancer are the goals.

Carcinogenesis is not simply an event but a process, a continuum of discrete cellular changes over time resulting in more autonomous cellular processes. Prevention concerns the identification and manipulation of the genetic, biologic, and environmental factors in the causal pathway of cancer.

### EDUCATION AND HEALTHFUL HABITS

Public education on the avoidance of identified risk factors for cancer and encouraging healthy habits contributes to cancer prevention and control. The physician is a powerful messenger in this education campaign. The patient-physician encounter provides an opportunity to teach patients about the hazards of smoking, the features of a healthy lifestyle (including diet and exercise), use of proven cancer screening methods, and sun avoidance.

#### **Smoking Cessation**

Tobacco smoking is the most modifiable risk factor for cardiovascular disease, pulmonary disease, and cancer. Smokers have a 33% lifetime risk of dying prematurely

from a tobacco-related cancer, cardiovascular, or pulmonary disease. Tobacco use causes more deaths from cardiovascular disease than from cancer. Lung cancer and cancers of the larynx, oropharynx, esophagus, kidney, bladder, pancreas, and stomach are all tobacco-related.

The degree of smoke exposure, meaning the number of cigarettes smoked per day as well as the level of inhalation of cigarette smoke, is correlated with risk of lung cancer mortality. Light- and low-tar cigarettes are not safer because smokers tend to inhale them more frequently and deeply.

Those who stop smoking have a 30–50% lower 10-year lung cancer mortality rate compared to those who continue smoking, despite the fact that some carcinogen-induced gene mutations persist for years after smoking cessation. Smoking cessation and avoidance have the potential to save more lives than any other public health activity.

The risk of tobacco smoke is not limited to the smoker. Environmental tobacco smoke, known as secondhand or passive smoke, causes lung cancer and other cardiopulmonary diseases in nonsmokers.

Tobacco prevention is a pediatric issue. Over 80% of adult American smokers began smoking before the age of 18. Nearly 20% of Americans 12–18 years of age have smoked a cigarette in the past month. Counseling of adolescents and young adults is critical to prevent smoking. A physician's simple advice not to start smoking or to quit smoking can be of benefit. Physicians should query patients on tobacco use on every office visit,

record the answer with the vital signs, and ask smokers if they would like assistance in quitting.

Current approaches to smoking cessation recognize that smoking is an addiction. The smoker who is quitting goes through a process with identifiable stages that include contemplation of quitting, an action phase in which the smoker quits, and a maintenance phase. Smokers who quit completely are more likely to be successful than those who gradually reduce the number of cigarettes smoked or change to lower tar or nicotine cigarettes. More than 90% of the Americans who have successfully quit smoking did so on their own without participation in an organized cessation program, but cessation programs are helpful for some smokers. The Community Intervention Trial for Smoking Cessation (COMMIT) was a 4-year program; it demonstrated that light smokers (<25 cigarettes per day) were more likely to benefit from simple cessation messages and cessation programs. Quit rates were 30.6% in the intervention group and 27.5% in the control group. The COMMIT interventions were not successful in heavy smokers (>25 cigarettes per day). Heavy smokers may need an intensive broad-based cessation program that includes counseling, behavioral strategies, and pharmacologic adjuncts, such as nicotine replacement (gum, patches, sprays, lozenges, and inhalers) and bupropion.

Cigar smoking has increased in the past decade. The health risks of cigars are similar to those of cigarettes. Smoking one or two cigars daily doubles the risk for oral and esophageal cancers; three or four cigars daily increases the risk of oral cancers more than eightfold and esophageal cancer fourfold. The risks of occasional use are unknown.

Smokeless tobacco is the fastest growing part of the tobacco industry and represents a substantial health risk. Chewing tobacco is a carcinogen linked to dental caries, gingivitis, oral leukoplakia, and oral cancer. The systemic effects of smokeless tobacco may increase risks for other cancers. Esophageal cancer is linked to carcinogens in tobacco being dissolved in saliva, swallowed, and coming into contact with the esophagus.

**Physical Activity**

Physical activity is associated with a decreased risk of colon and breast cancer. A variety of mechanisms have been proposed. However, such studies are prone to confounding factors such as recall bias, association of exercise with other health-related practices, and effects of preclinical cancers on exercise habits (reverse causality). Recommending adults to engage in at least 30 min of vigorous activity for ≥3 days a week is good health advice, although its effects on cancer incidence are unproven.

**Diet Modification**



International epidemiologic studies suggest that diets high in fat are associated with increased risk for cancers of the breast, colon, prostate, and

endometrium. These cancers have their highest incidence and mortalities in Western culture where fat comprises an average of 40–45% of the total calories consumed. In populations at low risk for these cancers, fat accounts for <20% of dietary calories.

Despite correlations, dietary fat has not been proven to cause cancer. Case-control and cohort epidemiologic studies give conflicting results. In addition, diet is a highly complex exposure to many nutrients and chemicals. Low-fat diets are associated with many dietary changes beyond simple subtraction of fat. Other lifestyle changes are also associated with adherence to a low-fat diet. The Women’s Intervention Nutrition Study (WINS) evaluated the effects of low-fat diet on breast cancer recurrence in previously treated postmenopausal breast cancer patients. Breast cancer patients, mean age 62 years, were randomly assigned to a standard diet (40% fat) or a low-fat diet (26% fat). At 5 years, breast cancer had recurred in 9.8% of women in the low-fat diet group compared to 12.4% of women on the standard diet.

In observational studies, dietary fiber lowers the risk of colonic polyps and invasive cancer of the colon. However, cancer-protective effects of increasing fiber and lowering dietary fat have not been proven in the context of a prospective clinical trial. The putative protective mechanisms are complex and speculative. Fiber binds oxidized bile acids and generates soluble fiber products, such as butyrate, that may have differentiating properties. Fiber does not increase bowel transit times. High-fiber diets could lower the risk of breast and prostate cancer by absorbing and inactivating dietary estrogenic and androgenic cancer promoters. However, two large prospective cohort studies of >100,000 health professionals showed no association between fruit and vegetable intake and risk of cancer.

The Polyp Prevention Trial randomly assigned 2000 elderly persons, who had polyps removed, to a low-fat, high-fiber diet versus routine diet for 4 years. No differences were noted in polyp formation.

The U.S. National Institutes of Health Women’s Health Initiative, launched in 1994, is a long-term clinical trial enrolling >100,000 women ages 45–69. It placed women in 22 intervention groups. Participants received calcium/vitamin D supplementation, hormone-replacement therapy, and counseling to increase exercise, eat a low-fat diet, and cease smoking. The study showed that although dietary fat intake was significantly lower in the diet intervention group, invasive breast cancers were not reduced over an 8-year follow-up period compared to the control group. The difference in dietary fat averaged ~10% between the two groups. Scientific evidence does not currently establish the anticarcinogenic value of vitamin, mineral, or nutritional supplements in amounts greater than those provided by a balanced diet. However, consuming at least five servings of fruits and vegetables a day decreases dietary fat and

334 increases fiber; such a diet may lower the risk of cardiovascular disease even if it does not influence cancer.

### Energy Balance

Risk of cancer increases as body mass index increases over 25 kg/m<sup>2</sup>. Obesity increases risks for cancers of the colon, breast (female postmenopausal), endometrium, kidney (renal cell), and esophagus, although causality is not established.

Relative risks of colon cancer are increased in obesity by 1.5–2.0 for men and 1.2–1.5 for women. Obese postmenopausal women have a 30–50% increased risk of breast cancer. A hypothesis for the association is that adipose tissue serves as a depot for aromatase that facilitates estrogen production. Adiposity is also associated with poorer survival and increased risk of recurrence after treatment.

### Sun Avoidance

Nonmelanoma skin cancers (basal cell and squamous cell) are induced by cumulative exposure to ultraviolet (UV) radiation. Intermittent acute sun exposure and sun damage have been linked to melanoma. Sunburns, especially in childhood and adolescence, are associated with increased risk of melanoma in adulthood. Reduction of sun exposure through use of protective clothing and changing patterns of outdoor activities can reduce skin cancer risk. Sunscreens decrease the risk of actinic keratoses, the precursor to squamous cell skin cancer, but melanoma risk may be increased. Sunscreens prevent burning, but they may encourage more prolonged exposure to the sun and may not filter out wavelengths of energy that cause melanoma.

Educational interventions to help individuals accurately assess their risk of developing skin cancer have some impact. Self-examination for skin pigment characteristics associated with melanoma, such as freckling, may be useful in identifying people at high risk. Those who recognize themselves as being at risk tend to be more compliant with sun-avoidance recommendations. Risk factors for melanoma include a propensity to sunburn, a large number of benign melanocytic nevi, and atypical nevi.

## CANCER CHEMOPREVENTION

Chemoprevention involves the use of specific natural or synthetic chemical agents to reverse, suppress, or prevent carcinogenesis before the development of invasive malignancy.

Cancer develops through an accumulation of genetic and epigenetic changes that are potential points of intervention to prevent cancer. The initial changes are termed *initiation*. The alteration can be inherited or

acquired through the action of physical, infectious, or chemical carcinogens. Like most human diseases, cancer arises from an interaction between genetics and environmental exposures (Table 26-1). Influences that cause the initiated cell to progress through the carcinogenic process and change phenotypically are termed *promoters*. Promoters include hormones such as androgens, linked to prostate cancer, and estrogen, linked to breast and endometrial cancer. The distinction between an initiator and promoter is sometimes arbitrary; some components of cigarette smoke are “complete carcinogens,” acting as both initiators and promoters. Cancer can be prevented or controlled through interference with the factors that cause cancer initiation, promotion, or progression. Compounds of interest in chemoprevention often have antimutagenic, antioxidant, anti-inflammatory, antiproliferative, or proapoptotic activity (or a combination).

### Chemoprevention of Cancers of the Upper Aerodigestive Tract

Smoking causes diffuse epithelial injury in the head, neck, esophagus, and lung. Patients cured of squamous cell cancers of the lung, esophagus, head, and neck are at risk (as high as 5% per year) of developing second cancers of the upper aerodigestive tract. Cessation of cigarette smoking does not markedly decrease the cured cancer patient’s risk of second malignancy, even though it does lower the cancer risk in those who have never developed a malignancy. Smoking cessation may halt the early stages of the carcinogenic process (such as metaplasia), but it may have no effect on late stages of carcinogenesis. This “field carcinogenesis” hypothesis for upper aerodigestive tract cancer has made “cured” patients an important population for chemoprevention of second malignancies.

Oral leukoplakia, a premalignant lesion commonly found in smokers, has been used as an intermediate marker allowing demonstration of chemopreventive activity in smaller shorter duration, randomized, placebo-controlled trials. Response was associated with upregulation of retinoic acid receptor- $\beta$  (RAR- $\beta$ ). Therapy with high, relatively toxic doses of isotretinoin (13-*cis*-retinoic acid) causes regression of oral leukoplakia. However, the lesions recur when the therapy is withdrawn, suggesting the need for chronic administration. More tolerable doses of isotretinoin have not proven beneficial in the prevention of head and neck cancer. Isotretinoin also failed to prevent second malignancies in patients cured of early-stage non-small cell lung cancer; mortality rates were actually increased in current smokers.

Premalignant lesions in the oropharyngeal area have also responded to retinol,  $\alpha$ -tocopherol (vitamin E), and selenium. Further study to define the activity of these drugs is ongoing.

TABLE 26-1

SUSPECTED CARCINOGENS	
CARCINOGENS <sup>a</sup>	ASSOCIATED CANCER OR NEOPLASM
Alkylating agents	Acute myeloid leukemia, bladder cancer
Androgens	Prostate cancer
Aromatic amines (dyes)	Bladder cancer
Arsenic	Cancer of the lung, skin
Asbestos	Cancer of the lung, pleura, peritoneum
Benzene	Acute myelocytic leukemia
Chromium	Lung cancer
Diethylstilbestrol (prenatal)	Vaginal cancer (clear cell)
Epstein-Barr virus	Burkitt's lymphoma, nasal T cell lymphoma
Estrogens	Cancer of the endometrium, liver, breast
Ethyl alcohol	Cancer of the liver, esophagus, head and neck
<i>Helicobacter pylori</i>	Gastric cancer, gastric MALT lymphoma
Hepatitis B or C virus	Liver cancer
Human immunodeficiency virus	Non-Hodgkin's lymphoma, Kaposi's sarcoma, squamous cell carcinomas (especially of the urogenital tract)
Human papilloma virus	Cervix cancer, head and neck cancer
Human T cell lymphotropic virus type I (HTLV-I)	Adult T cell leukemia/lymphoma
Immunosuppressive agents (azathioprine, cyclosporine, glucocorticoids)	Non-Hodgkin's lymphoma
Nitrogen mustard gas	Cancer of the lung, head and neck, nasal sinuses
Nickel dust	Cancer of the lung, nasal sinuses
Phenacetin	Cancer of the renal pelvis and bladder
Polycyclic hydrocarbons	Cancer of the lung, skin (especially squamous cell carcinoma of scrotal skin)
Schistosomiasis	Bladder cancer (squamous cell)
Sunlight (ultraviolet)	Skin cancer (squamous cell and melanoma)
Tobacco (including smokeless)	Cancer of the upper aerodigestive tract, bladder
Vinyl chloride	Liver cancer (angiosarcoma)

<sup>a</sup>Agents that are thought to act as cancer initiators and/or promoters.

Several large-scale trials have assessed agents in the chemoprevention of lung cancer in patients at high risk. In the  $\alpha$ -tocopherol/ $\beta$ -carotene (ATBC) Lung Cancer Prevention Trial, participants were male smokers, age 50–69 at entry. Participants had smoked an average of one pack of cigarettes per day for 35.9 years. Participants received  $\alpha$ -tocopherol,  $\beta$ -carotene, and/or placebo in a randomized,  $2 \times 2$  factorial design. After median follow-up of 6.1 years, lung cancer incidence and mortality were statistically significantly increased in those receiving  $\beta$ -carotene.  $\alpha$ -Tocopherol had no effect on lung cancer mortality, and no evidence suggested interaction between the two drugs. Patients receiving  $\alpha$ -tocopherol had a higher incidence of hemorrhagic stroke.

The  $\beta$ -Carotene and Retinol Efficacy Trial (CARET) involved 17,000 American smokers and workers with asbestos exposure. Entrants were randomly assigned to one of four arms and received  $\beta$ -carotene, retinol, and/or placebo in a  $2 \times 2$  factorial design. This trial also demonstrated harm from  $\beta$ -carotene: a lung cancer rate

of 5 per 1000 subjects per year for those taking placebo and of 6 per 1000 subjects per year for those taking  $\beta$ -carotene.

The ATBC and CARET results demonstrate the importance of testing chemoprevention hypotheses thoroughly before their widespread implementation because the results contradict a number of observational studies. In the ATBC trial, those taking  $\alpha$ -tocopherol had a one-third reduction in the incidence of prostate cancer, compared to those not taking  $\alpha$ -tocopherol. The Physicians' Health Trial showed no change in the risk of lung cancer for those taking  $\beta$ -carotene; fewer of its participants were smokers than those in the ATBC and CARET studies.

### **Chemoprevention of Colon Cancer**

Many of the current colon cancer prevention trials are based on the premise that most colorectal cancers develop from adenomatous polyps. These trials use



336 adenoma recurrence or disappearance as a surrogate end point for colon cancer prevention. Early clinical trial results suggest that nonsteroidal anti-inflammatory drugs (NSAIDs), such as piroxicam, sulindac, and aspirin, may prevent adenoma formation or cause regression of adenomatous polyps. The mechanism of action of NSAIDs is unknown, but they are presumed to work through the cyclooxygenase pathway. In the Physicians' Health Trial, aspirin had no effect on colon cancer incidence, although the 6-year assessment period may not have been long enough to evaluate this end point definitively. A number of studies suggest that NSAID use is associated with a lower risk of adenomatous polyps and invasive cancer. However, prospective trials have not shown that NSAIDs prevent colon cancer.

Cyclooxygenase-2 (COX-2) inhibitors may be even more effective. In a placebo-controlled trial, high-dose celecoxib reduced the recurrence of colorectal polyps in patients with familial adenomatous polyposis. The effect on colon cancer occurrence is unknown. Trials for prevention of sporadic colorectal cancers with COX-2 inhibitors were initiated but have been complicated by the association of these drugs with cardiovascular disease.

Epidemiologic studies suggest that diets high in calcium lower colon cancer risk. Calcium binds bile and fatty acids, which cause proliferation of colonic epithelium. It is hypothesized that calcium reduces intraluminal exposure to these compounds. Calcium supplementation decreases the risk of adenomatous polyp recurrence by ~20%. Trials of calcium with cancer-incidence end points are underway.

The Women's Health Initiative demonstrated that postmenopausal women taking Premarin plus progestin have a 44% lower risk of colorectal cancer compared to women taking placebo. Of >16,600 women randomized and followed for a median of 5.6 years, 43 invasive colorectal cancers occurred in the hormone group and 72 in the placebo group. The positive effect on colon cancer is mitigated by the modest increase in cardiovascular and breast cancer risks associated with combined estrogen plus progestin therapy. Colorectal cancers diagnosed in women taking estrogen and progestin were in a more advanced stage than those in women taking placebo.

A case-control study suggested that statins decrease the incidence of colorectal cancer. However, a meta-analysis of statin use showed no protective effect of statins on overall cancer incidence or death.

### **Chemoprevention of Breast Cancer**

Hormonal manipulation is being tested in the primary prevention of breast cancer. Tamoxifen is an antiestrogen with partial estrogen agonistic activity in some tissues, such as endometrium and bone. One of its actions is to upregulate transforming growth factor  $\beta$ , which decreases breast cell proliferation. In randomized placebo-controlled

trials to assess tamoxifen as adjuvant therapy for breast cancer, tamoxifen reduced the number of new breast cancers in the opposite breast by more than a third. In a randomized placebo-controlled prevention trial involving >13,000 women at high risk, tamoxifen decreased the risk of developing breast cancer by 49% (from 43.4 to 22.0 per 1000 women) after a median follow-up of nearly 6 years. The International Breast Cancer Intervention Study (IBIS-I) trial had similar findings. In both studies tamoxifen also reduced bone fractures; a small increase in risk of endometrial cancer, stroke, pulmonary emboli, and deep vein thrombosis was noted. Tamoxifen has been approved by the U.S. Food and Drug Administration for reduction of breast cancer in women at high risk for the disease (1.66% risk at 5 years based on the Gail risk model: [http://www.nci.nih.gov/cancertopics/pdq/genetics/breast-and-ovarian/healthprofessional#Section\\_66](http://www.nci.nih.gov/cancertopics/pdq/genetics/breast-and-ovarian/healthprofessional#Section_66)).

A trial comparing tamoxifen with another selective estrogen receptor modulator, raloxifene, showed that raloxifene is comparable to tamoxifen in cancer prevention. Raloxifene is associated with more noninvasive breast cancer than tamoxifen; the drugs are similar in risks of other cancers, fractures, ischemic heart disease, and stroke. Because the aromatase inhibitors are even more effective than tamoxifen in adjuvant breast cancer therapy, it is hoped that they also are more effective in breast cancer prevention. However, no data are available on this point.

### **Chemoprevention of Prostate Cancer**

Finasteride is a 5- $\alpha$ -reductase inhibitor. It inhibits conversion of testosterone to dihydrotestosterone (DHT), a potent stimulator of prostate cell proliferation. The Prostate Cancer Prevention Trial randomly assigned men  $\geq 55$  years of age at average risk of prostate cancer to finasteride or placebo. After 7 years of therapy, the incidence of prostate cancer was 18.4% in the finasteride arm and 24.8% in the placebo arm, a statistically significant difference. However, the finasteride group had more patients with tumors of Gleason score  $\geq 7$  compared to the placebo arm (6.4% vs 5.1%). The clinical significance of this finding, if any, is unknown.

Selenium is being tested as a prostate cancer preventive based on laboratory studies, epidemiologic data, and a small randomized skin cancer prevention trial that showed a significantly decreased number of prostate cancers in men taking selenium. In the placebo group, 16 prostate cancers were diagnosed versus 4 in the treatment group among the 843 men who began the study with a serum prostate specific antigen level  $< 4$  ng/mL.

The ATBC study cited earlier showed in secondary analysis that the risk of prostate cancer was reduced 33% in men taking  $\alpha$ -tocopherol (99 cases in those on the drug; 151 cases on placebo). A prospective randomized trial to assess these drugs is ongoing.

## Vaccines and Cancer Prevention



A number of infectious agents cause cancer. Hepatitis B and C are linked to liver cancer, some human papilloma virus (HPV) strains are linked to cervical and head and neck cancer, and *Helicobacter pylori* is associated with gastric cancer and lymphoma. Vaccines to protect against these agents may reduce the risk of their associated cancers.

The hepatitis B vaccine is effective in preventing hepatitis and hepatomas due to chronic hepatitis B infection. Public health officials are encouraging widespread administration of the hepatitis B vaccine, especially in Asia, where the disease is epidemic.

A four-valent HPV vaccine (Gardasil) is 100% effective at preventing infection with any of the four component strains (6, 11, 16, 18). The vaccine is recommended for girls and women 9–26 years of age. Reduction in these HPV types could prevent >70% of the cervical cancers worldwide.

### SURGICAL PREVENTION OF CANCER

Some organs in some individuals are at such high risk of developing cancer that surgical removal of the organ at risk is recommended. Women with severe cervical dysplasia are treated with conization and occasionally even hysterectomy. Colectomy is used to prevent colon cancer in patients with familial polyposis or ulcerative colitis.

Prophylactic bilateral mastectomy is chosen for breast cancer prevention among women with genetic predisposition to breast cancer. In a prospective series of 139 women with *BRCA1* and *BRCA2* mutations, 76 chose to undergo prophylactic mastectomy and 63 chose close surveillance. At 3 years, no cases of breast cancer had been diagnosed in those opting for surgery, but eight in the surveillance group had developed breast cancer. A larger retrospective cohort study reported that prophylactic mastectomy could reduce risk of breast cancer by 90%. The effect of the procedure on mortality is unknown. Observational studies are prone to a variety of biases associated with the choice to undergo prophylactic surgery; thus such studies can give an overestimate of the magnitude of benefit.

Surgery is also used to manage hormonal cancers. Orchiectomy is an effective method of androgen deprivation in prostate cancer, and oophorectomy is effective in hormone-dependent breast cancer.

### CANCER SCREENING

Screening is a means of detecting disease early in asymptomatic individuals, with the goal of decreasing morbidity and mortality. Although screening can potentially save lives and has been shown to do so in cervical, colon, and probably breast cancer, it is also subject to a

number of biases that can suggest a benefit when actually there is none. Biases can even mask net harm. Early detection does not in itself confer benefit. To be of value, screening must detect disease earlier, and treatment of earlier disease must yield a better outcome than treatment at the onset of symptoms. Cause-specific mortality, rather than survival after diagnosis, is the preferred end point (see later).

Because screening is done on asymptomatic, healthy persons, it should offer substantial likelihood of benefit that outweighs harm. Screening tests and their appropriate use should be carefully evaluated before their use is widely encouraged in screening programs, as a matter of public policy.

Screening examinations, tests, or procedures are usually not diagnostic of cancer but instead indicate that a cancer may be present. The diagnosis is then made following a workup that includes a biopsy and pathologic confirmation.

A number of genes have been identified that predispose for a disease, and many more will be identified in the near future. Testing for these genes can define a high-risk population. The ability to predict the development of a particular cancer may some day present therapeutic options as well as ethical dilemmas. It may eventually allow for early intervention to prevent a cancer or limit its severity. People at high risk may be ideal candidates for chemoprevention and screening; however, efficacy of these interventions in the high-risk population should be investigated. Currently, persons at high risk for a particular cancer can engage in intensive screening. Although this course is clinically prudent, it is not known if it saves lives in these populations.

### The Accuracy of Screening

A screening test's accuracy or ability to discriminate disease is described by four indices: sensitivity, specificity, positive predictive value, and negative predictive value (Table 26-2). *Sensitivity*, also called the true positive rate, is the proportion of persons with the disease testing positive in the screen (i.e., the ability of the test to detect disease when it is present). *Specificity*, or 1-false positive rate, is the proportion of persons who do not have the disease and test negative in the screening test (i.e., the ability of a test to correctly identify that the disease is not present). The *positive predictive value* is the proportion of persons that test positive who actually have the disease. Similarly, *negative predictive value* is the proportion testing negative who do not have the disease. The sensitivity and specificity of a test are relatively independent of the underlying prevalence (or risk) of the disease in the population screened, but the predictive values depend strongly on the prevalence of the disease.

Screening is most beneficial, efficient, and economical when the target disease is common in the population

TABLE 26-2

ASSESSMENT OF THE VALUE OF A DIAGNOSTIC TEST<sup>a</sup>

	CONDITION PRESENT	CONDITION ABSENT
Positive test	<i>a</i>	<i>b</i>
Negative test	<i>c</i>	<i>d</i>
<i>a</i> = true positive		
<i>b</i> = false positive		
<i>c</i> = false negative		
<i>d</i> = true negative		
Sensitivity	The proportion of persons with the condition who test positive: $a/(a + c)$	
Specificity	The proportion of persons without the condition who test negative: $d/(b + d)$	
Positive predictive value (PPV)	The proportion of persons with a positive test who have the condition: $a/(a + b)$	
Negative predictive value	The proportion of persons with a negative test who do not have the condition: $d/(c + d)$	
Prevalence, sensitivity, and specificity determine PPV		
$PPV = \frac{\text{prevalence} \times \text{sensitivity}}{(\text{prevalence} \times \text{sensitivity}) + (1 - \text{prevalence})(1 - \text{specificity})}$		

<sup>a</sup>For diseases of low prevalence, such as cancer, poor specificity has a dramatic adverse effect on PPV such that only a small fraction of positive tests are true positives.

being screened. To be valuable, the screening test should have a high specificity; sensitivity need not be very high.

### Potential Biases of Screening Tests

The common biases of screening are lead time, length-biased sampling, and selection. These biases can make a screening test seem beneficial when actually it is not (or even causes net harm). Whether beneficial or not, screening can create the false impression of an epidemic by increasing the number of cancers diagnosed. It can also produce a shift in proportion of patients diagnosed at an early stage that improves survival statistics without reducing mortality (i.e., the number of deaths from a given cancer relative to the number of those at risk for the cancer). In such a case, the *apparent* duration of survival (measured from date of diagnosis) increases without lives being saved or life expectancy changed.

*Lead-time bias* occurs when a test does not influence the natural history of the disease; the patient is merely diagnosed at an earlier date. When lead-time bias occurs, survival *appears* increased, but life is not really prolonged. The screening test only prolongs the time the subject is aware of the disease and spends as a patient.

*Length-biased sampling* occurs when slow-growing, less aggressive cancers are detected during screening. Cancers diagnosed due to the onset of symptoms between scheduled screenings are on average more aggressive, and treatment outcomes are not as favorable. An extreme form of length bias sampling is termed *overdiagnosis*, the detection of “pseudo disease.” The reservoir of some

undetected slow-growing tumors is large. Many of these tumors fulfill the histologic criteria of cancer but will never become clinically significant or cause death. This problem is compounded by the fact that the most common cancers appear most frequently at ages when competing causes of death are more frequent.

*Selection bias* must be considered in assessing the results of any screening effort. The population most likely to seek screening may differ from the general population to which the screening test might be applied. The individuals screened may have volunteered because of a particular risk factor not found in the general population, such as a strong family history. In general, volunteers for studies are more health conscious and likely to have a better prognosis or lower mortality rate, irrespective of the screening result. This is termed the *healthy volunteer effect*.

### Potential Drawbacks of Screening

Risks associated with screening include harm caused by the screening intervention itself, harm due to the further investigation of persons with positive tests (both true and false positives), and harm from the treatment of persons with a true-positive result, even if life is extended by treatment. The diagnosis and treatment of cancers that would never have caused medical problems can lead to the harm of unnecessary treatment and give patients the anxiety of a cancer diagnosis. The psychosocial impact of cancer screening can also be substantial when applied to the entire population.

## Assessment of Screening Tests

Good clinical trial design can offset some biases of screening and demonstrate the relative risks and benefits of a screening test. A randomized, controlled screening trial with cause-specific mortality as the end point provides the strongest support for a screening intervention. Overall survival should also be reported to detect an adverse effect of screening and treatment on other disease outcomes (e.g., cardiovascular disease). In a randomized trial, two like populations are randomly established. One is given the medical standard of care (which may be no screening at all) and the other receives the screening intervention being assessed. The two populations are compared over time. Efficacy for the population studied is established when the group receiving the screening test has a better cause-specific mortality rate than the control group. Studies showing a reduction in the incidence of advanced-stage disease, an improved survival, or a stage shift are weaker (and possibly misleading) evidence of benefit. These latter criteria are necessary but not sufficient to establish the value of a screening test.

Although a randomized, controlled screening trial provides the strongest evidence to support a screening test, it is not perfect. Unless the trial is population-based, it does not remove the question of generalizability to the target population. Screening trials generally involve thousands of persons and last for years. Less definitive study designs are

therefore often used to estimate the effectiveness of screening practices. After a randomized controlled clinical trial, in descending order of strength, evidence may be derived from the findings of internally controlled trials using intervention allocation methods other than randomization (e.g., allocation by birth date, date of clinic visit); the findings of cohort or case-control analytic observational studies; the results of multiple time series study with or without the intervention; the opinions of respected authorities based on clinical experience, descriptive studies, or consensus reports of experts (the weakest form of evidence because even experts can be misled by biases).

## Screening for Specific Cancers

Widespread screening for cervical, colon, and likely breast cancer is beneficial for certain age groups. A number of organizations have considered whether or not to endorse routine use of certain screening tests. Because these groups have not used the same criteria to judge whether a screening test should be endorsed, they have arrived at different recommendations. The U.S. Preventive Services Task Force (USPSTF), the Canadian Task Force on Preventive Health Care, and the American Cancer Society (ACS) publish screening guidelines (Table 26-3). Special surveillance of those at high risk for a specific cancer because of a family history or a

**TABLE 26-3**

### SCREENING RECOMMENDATIONS FOR ASYMPTOMATIC NORMAL-RISK SUBJECTS<sup>a</sup>

TEST OR PROCEDURE	USPSTF	ACS	CTFPHC
Sigmoidoscopy	Fair evidence to recommend	≥50, every 5 years	Fair evidence to consider
Fecal occult blood testing	≥50, good evidence for every 1–2 years	≥50, every year	Good evidence, age ≥50
Colonoscopy	No direct evidence	≥50, every 10 years	No direct evidence
Digital rectal examination	No recommendation	No recommendation	No recommendation
Prostate-specific antigen	Insufficient evidence to recommend	M: ≥50, every year	Recommendation against
Pap test	F: 18–65, every 1–3 years	F: with uterine cervix, beginning 3 years after first intercourse or by age 21. Yearly for standard Pap; every 2 years with liquid test.	Fair evidence to include in examination of sexually active women
Pelvic examination	No recommendation, advise adnexal palpation during exam for other reasons	F: 18–40, every 1–3 years with Pap test; >40, every year	Not considered
Breast self-examination	No recommendation	≥20, monthly	Fair evidence to exclude
Breast clinical examination	Insufficient evidence as a stand-alone without mammography	F: 20–40, every 3 years; >40, yearly	F: 50–69, every 1–2 years
Mammography	F: 40–75, every 1–2 years (fair evidence)	F: ≥40, every year	F: 50–69, every 1–2 years
Complete skin examination	Insufficient evidence for or against	Periodic exam	Poor evidence to include or exclude

<sup>a</sup>Summary of the screening procedures recommended for the general population by U.S. Preventive Services Task Force (USPSTF), the American Cancer Society (ACS), and the Canadian Task Force on Prevention Health Care (CTFPHC). These recommendations refer to asymptomatic persons who have no risk factors, other than age or gender, for the targeted condition.

**Note:** F, female; M, male.

340 genetic risk factor may be prudent, but few studies have assessed the influence on mortality.

### Breast Cancer

Breast self-examination, clinical breast examination by a caregiver, and mammography have been advocated as useful screening tools. Only screening mammography alone and screening mammography with clinical examination have been evaluated in randomized controlled trials. MRI is being assessed and is more accurate than mammography in women at high risk due to genetic predisposition or in women with very dense breast tissue.

A number of trials have suggested that annual or biennial screening with mammography or mammography plus clinical breast examination in normal-risk women >50 years of age decreases breast cancer mortality. Each trial has been criticized for design flaws. In most trials, breast cancer mortality rate is decreased by 20–30%. Experts disagree on whether average-risk women age 40–49 should receive regular screening (Table 26-3). The significance of the screening effect in women aged 40–49 depends on the statistical test used. An analysis of eight large randomized trials showed no benefit from mammography screening for women aged 40–49 when assessed 5–7 years after trial entry. However, a small benefit emerged 10–12 years after study entry. What proportion of this benefit is due to screening after these women turned 50 is not known. In randomized screening studies of women aged 50–69, the mortality decline begins ~5 years after initiation of screening. Nearly half of women aged 40–49 screened annually will have false-positive mammograms necessitating further evaluation, often including biopsy. The risk of false-positive testing should be discussed with the patient.

No study of breast self-examination has shown it to decrease mortality; however, it is recommended as prudent by many organizations. A substantial fraction of breast cancers are first detected by patients. Self-examination leads to increased biopsy rate without reducing breast cancer mortality.

Genetic screening for *BRCA1* and *BRCA2* mutations and other markers of breast cancer risk has identified a group of women at high risk for breast cancer. Unfortunately when to begin and the optimal frequency of screening have not been defined. Mammography is less sensitive at detecting breast cancers in women carrying *BRCA1* and -2 mutations, possibly because such cancers occur in younger women, in whom mammography is known to be less sensitive. MRI screening may be more effective.

### Cervical Cancer

Screening with Papanicolaou smears decreases cervical cancer mortality. The cervical cancer mortality rate has

fallen substantially since the widespread use of the Pap smear. Most screening guidelines recommend regular Pap testing for all women who are or have been sexually active for 3 years or have reached the age of 21. With the onset of sexual activity comes the risk of sexual transmission of HPV, the most common etiologic factor for cervical cancer. The recommended interval for Pap screening varies from 1–3 years. At age 30, women who have had three normal test results in a row may get screened every 2–3 years. An upper age limit at which screening ceases to be effective is not known, but women  $\geq 70$  years with no abnormal results in the previous 10 years may choose to stop screening.

### Colorectal Cancer

Fecal occult blood testing (FOBT), digital rectal examination (DRE), rigid and flexible sigmoidoscopy, radiographic barium contrast studies, and colonoscopy have been considered for colorectal cancer screening. Annual FOBT could reduce colorectal cancer mortality by a third. The sensitivity for fecal occult blood is increased if specimens are rehydrated before testing, but at the cost of lower specificity. The false-positive rate for rehydrated FOBT is high; 1–5% of persons tested have a positive test. Only 2–10% of those with occult blood in the stool have cancer and 20–30% have adenomas. The high false-positive rate of FOBT dramatically increases the number of colonoscopies performed.

Two case-control studies suggest that regular screening of those >50 years of age with sigmoidoscopy decreases mortality. This type of study is prone to selection biases. A quarter to a third of polyps can be discovered with the rigid sigmoidoscope; half are found with a 35-cm flexible scope, and two-thirds to three-quarters are found with a 60-cm scope. Diagnosis of adenomatous polyps by sigmoidoscopy should lead to evaluation of the entire colon with colonoscopy and/or barium enema. The most efficient interval for screening sigmoidoscopy is unknown, but 5 years is often recommended. Case-control studies suggest that intervals of up to 15 years may confer benefit.

Onetime colonoscopy detects ~25% more advanced lesions (polyps >10 mm, villous adenomas, adenomatous polyps with high-grade dysplasia, invasive cancer) than onetime FOBT with sigmoidoscopy. Colonoscopy is well suited to screening subjects at high risk, such as those with ulcerative colitis or family predisposition. Perforation rates are 3 in 1000 for colonoscopy and 1 in 1000 for sigmoidoscopy. Debate continues on whether colonoscopy is too expensive and invasive for widespread use as a screening tool in standard-risk populations. DRE and barium enema are both insensitive as screening tools.

### Lung Cancer

Chest x-ray and sputum cytology have been evaluated in randomized lung cancer screening trials. No reduction in lung cancer mortality has been seen, although all the controlled trials have had low statistical power. Even screening of high-risk subjects (smokers) has not proven beneficial. Spiral CT can diagnose lung cancers at early stages; however, false-positive rates are high. Spiral CT screening increases the number of lesions detected and increases the number of diagnostic and therapeutic procedures. However, its capacity to save lives is unproven.

### Ovarian Cancer

Adnexal palpation, transvaginal ultrasound, and serum CA-125 assay have been considered for ovarian cancer screening. These tests alone and in combination do not have sufficiently high sensitivity or specificity to be recommended for routine screening of ovarian cancer. The risks and costs associated with the high number of false-positive results is an impediment to routine use of these modalities for screening. Most expert panels have concluded that routine screening for ovarian cancer is not indicated for standard-risk women or those with single affected family members, but it might be worthwhile in families with genetic ovarian cancer syndromes.

### Prostate Cancer

The most common prostate cancer screening modalities are DRE and serum prostate-specific antigen (PSA) assay. Newer serum tests, such as measurement of bound to free serum PSA, have yet to be fully evaluated. An emphasis on PSA screening has caused prostate cancer to become the most common non-skin cancer diagnosed in American men. This disease is prone to lead-time bias, length bias, and overdiagnosis, and substantial debate rages among experts as to whether it is effective. Some experts are concerned that prostate cancer screening, more than screening for other cancers, may cause net harm. Prostate cancer screening clearly detects many asymptomatic cancers, but the ability to distinguish tumors that are lethal but still curable from those that pose little or no threat to health is limited. Men >50 years of age have a high prevalence of indolent, clinically insignificant prostate cancers. No trial has yet demonstrated the benefit of prostate cancer screening and treatment.

The placebo arm of the Prostate Cancer Prevention Trial showed that rigorous screening of low-risk men for 7 years leads to the diagnosis of prostate cancer in >12% of patients. In addition, 15% of men who had normal DRE and PSA levels after 7 years were found to have prostate cancer on biopsy despite the normal screening tests. Thus screening missed more disease than it found, and >27% of normal-risk men in their late 60s were found to have prostate cancer.

The effectiveness of treatments for low-stage prostate cancer is under study. However, both surgery and radiation therapy may cause significant morbidity, such as impotence and urinary incontinence. Comparison of radical prostatectomy to “watchful waiting” in clinically diagnosed (not screen-detected) prostate cancers showed a small decrease in prostate cancer death rate in the surgery arm. One life was saved for every 18–20 men treated with radical prostatectomy. Urinary incontinence and sexual impotence were more common in the surgery arm. One current screening recommendation is that men >50 years of age be offered screening and allowed to make a choice after being informed of potential risks and benefits (Table 26-3). A man should have a life expectancy of at least 10 years to be eligible for screening. The USPSTF has found insufficient evidence to recommend prostate cancer screening.

### Endometrial Cancer

Transvaginal ultrasound and endometrial sampling have been advocated as screening tests for endometrial cancer. Benefit from routine screening has not been shown. Transvaginal ultrasound and endometrial sampling are indicated for workup of vaginal bleeding in postmenopausal women but are not considered as screening tests in symptomatic women.

### Skin Cancer

Visual examination of all skin surfaces by the patient or by a health care provider is used in screening for basal and squamous cell cancers and melanoma. No prospective randomized study has been performed to look for a mortality decrease. Observational epidemiologic evidence from Scotland and Australia suggests that screening programs have caused a stage shift in melanomas diagnosed. Screening may reinforce sun avoidance and other skin cancer prevention behaviors.

### FURTHER READINGS

- BACH PB et al: Computed tomography screening and lung cancer outcomes. *JAMA* 297:953, 2007
- BARRETT-CONNOR E et al: Effects of raloxifene on cardiovascular events and breast cancer in postmenopausal women. *N Engl J Med* 355:125, 2006
- BENNS MV et al: Surgical prophylaxis for inheritable malignant diseases: Colorectal and gastric cancer. *Am Surg* 75:463, 2009
- FISHER B et al: Tamoxifen for prevention of breast cancer: Report of the National Surgical Adjuvant Breast and Bowel Project P-1 Study. *J Natl Cancer Inst* 90:1371, 1998
- FREEDLAND SJ, PARTIN AW: Prostate-specific antigen: Update 2006. *Urology* 67:458, 2006
- HUMPHREY LL et al: Breast cancer screening: A summary of the evidence for the U.S. Preventive Services Task Force. *Ann Intern Med* 137:347, 2002

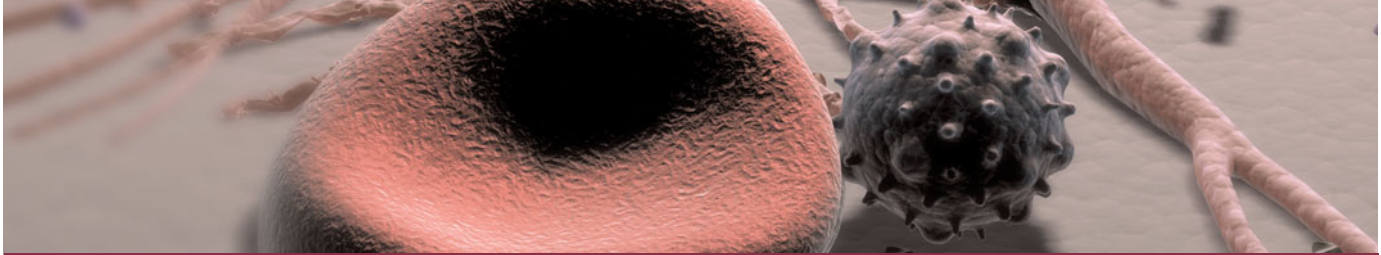
- 342 LIPPMAN SM, HAWK ET: Cancer prevention: From 1727 to milestones of the past 100 years. *Cancer Res* 69:5269, 2009
- PRENTICE RL et al: Low-fat dietary pattern and risk of invasive breast cancer. The Women's Health Initiative randomized controlled dietary modification trial. *JAMA* 295:629, 2006
- SMITH RA et al: Cancer screening in the United States, 2009: A review of current American Cancer Society guidelines and issues in cancer screening. *CA Cancer J Clin* 59:27, 2009
- THOMPSON IA et al: Chemoprevention of prostate cancer. *J Urol* 182:499, 2009
- WELLER DP et al: Uptake in cancer screening programmes. *Lancet Oncol* 10:693, 2009

WINAWER SJ et al: Guidelines for colonoscopy surveillance after polypectomy: A consensus update by the Multi-Society Task Force on Colorectal Cancer and the American Cancer Society. *Gastroenterology* 130:1872, 2006

## WEBSITES

The Canadian Task Force on Preventive Health Care  
<http://www.ctfphc.org/>

The National Cancer Institute CancerNet  
<http://cancer.net.nci.nih.gov/>



## CHAPTER 27

# PRINCIPLES OF CANCER TREATMENT

Edward A. Sausville ■ Dan L. Longo

■ Principles of Cancer Surgery . . . . .	.344	■ Principles of Chemotherapy . . . . .	.349
Prophylaxis . . . . .	.344	End Points of Drug Action . . . . .	.349
Diagnosis . . . . .	.344	Cancer Drugs: Overview and Principles for Use . . . . .	.351
Staging . . . . .	.345	Chemotherapeutic Agents Used for Cancer	
Treatment . . . . .	.345	Treatment . . . . .	.353
Palliation . . . . .	.346	Targeted Therapies . . . . .	.364
Rehabilitation . . . . .	.346	Acute Complications of Cancer Chemotherapy . . . . .	.366
■ Principles of Radiation Therapy . . . . .	.346	■ Biologic Therapy . . . . .	.370
Physical Properties and Biologic Effects . . . . .	.346	Immune Mediators of Antitumor Effects . . . . .	.371
Application to Patients . . . . .	.348	■ Gene Therapies . . . . .	.373
Toxicity . . . . .	.349	■ Further Readings . . . . .	.373

The goal of cancer treatment is first to eradicate the cancer. If this primary goal cannot be accomplished, the goal of cancer treatment shifts to palliation, the amelioration of symptoms, and preservation of quality of life while striving to extend life. The dictum *primum non nocere* is not the guiding principle of cancer therapy. When cure of cancer is possible, cancer treatments may be undertaken despite the certainty of severe and perhaps life-threatening toxicities. Every cancer treatment has the potential to cause harm, and treatment may be given that produces toxicity with no benefit. The therapeutic index of many interventions is quite narrow, and most treatments are given to the point of toxicity. Conversely, when the clinical goal is palliation, careful attention to minimizing the toxicity of potentially toxic treatments becomes a significant goal. Irrespective of the clinical scenario, the guiding principle of cancer treatment should be *primum succerrere*, “first hasten to help.” Radical surgical procedures, large-field hyperfractionated radiation therapy, high-dose chemotherapy, and maximum tolerable doses of cytokines such as interleukin (IL) 2 are all used in certain settings where 100% of the patients will experience toxicity and side effects from the intervention and only a fraction of the patients will experience benefit. One of the challenges of cancer treatment is to use the various treatment modalities

alone and together in a fashion that maximizes the chances for patient benefit.

Cancer treatments are divided into four main types: surgery, radiation therapy (including photodynamic therapy), chemotherapy (including hormonal therapy and molecularly targeted therapy), and biologic therapy (including immunotherapy and gene therapy). The modalities are often used in combination, and agents in one category can act by several mechanisms. For example, cancer chemotherapy agents can induce differentiation, and antibodies (a form of immunotherapy) can be used to deliver radiation therapy. Surgery and radiation therapy are considered local treatments, although their effects can influence the behavior of tumor at remote sites. Chemotherapy and biologic therapy are usually systemic treatments. *Oncology*, the study of tumors including treatment approaches, is a multidisciplinary effort with surgical-, radiotherapy-, and internal medicine-related areas of expertise. Treatments for patients with hematologic malignancies are often shared by hematologists and medical oncologists.

In many ways, cancer mimics an organ attempting to regulate its own growth. However, cancers have not set an appropriate limit on how much growth should be permitted. Normal organs and cancers share the property of having (1) a population of cells in cycle and



344 actively renewing and (2) a population of cells not in cycle. In cancers, cells that are not dividing are heterogeneous; some have sustained too much genetic damage to replicate but have defects in their death pathways that permit their survival, some are starving for nutrients and oxygen, and some are out of cycle but poised to be recruited back into cycle and expand if needed (i.e., reversibly growth-arrested). Severely damaged and starving cells are unlikely to kill the patient. The problem is that the cells that are reversibly not in cycle are capable of replenishing tumor cells physically removed or damaged by radiation and chemotherapy. These include *cancer stem cells*, whose properties are being elucidated. The stem cell fraction may define new targets for therapies that will retard their ability to reenter the cell cycle.

Tumors follow a Gompertzian growth curve (Fig. 27-1); the growth fraction of a neoplasm starts at 100% with the first transformed cell and declines exponentially over time until at the time of diagnosis, with a tumor burden of  $1-5 \times 10^9$  tumor cells, the growth fraction is usually 1-4%. Thus peak growth rate occurs before the tumor is detectable. A key feature of a successful tumor is the ability to stimulate the development of a new supporting stroma through angiogenesis and production of proteases to allow invasion through basement membranes and normal tissue barriers (Chap. 24). Specific cellular mechanisms promote entry or withdrawal

of tumor cells from the cell cycle. For example, when a tumor recurs after surgery or chemotherapy, frequently its growth is accelerated and the growth fraction of the tumor is increased. This pattern is similar to that seen in regenerating organs. Partial resection of the liver results in the recruitment of cells into the cell cycle, and the resected liver volume is replaced. Similarly, chemotherapy-damaged bone marrow increases its growth to replace cells killed by chemotherapy. However, cancers do not recognize a limit on their expansion. Monoclonal gammopathy of uncertain significance may be an example of a clonal neoplasm with intrinsic features that stop its growth before a lethal tumor burden is reached. A fraction of patients with this disorder go on to develop fatal multiple myeloma, but probably this occurs because of the accumulation of additional genetic lesions. Elucidation of the mechanisms that regulate this “organ-like” behavior of tumors may provide additional clues to cancer control and treatment.

## PRINCIPLES OF CANCER SURGERY

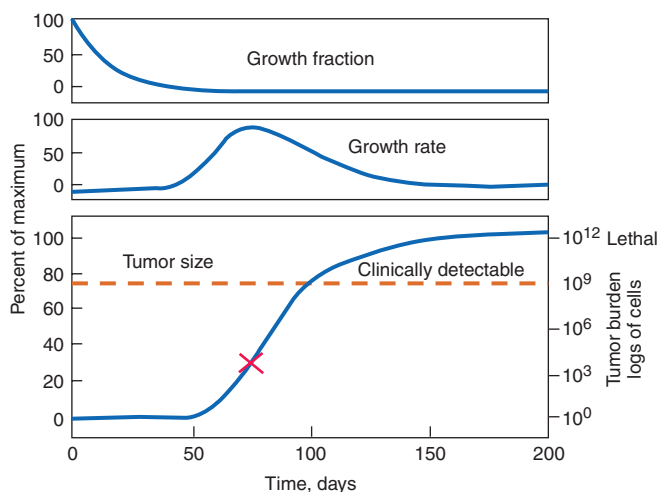
Surgery is used in cancer prevention, diagnosis, staging, treatment (for both localized and metastatic disease), palliation, and rehabilitation.

## PROPHYLAXIS

Cancer can be prevented by surgery in people who have premalignant lesions resected (e.g., premalignant lesions of skin, colon, cervix) and in those who are at increased risk of cancer from either an underlying disease (colectomy in those with pancolon involvement with ulcerative colitis), the presence of genetic lesions (colectomy for familial polyposis, thyroidectomy for multiple endocrine neoplasia type 2, bilateral mastectomy or oophorectomy for familial breast or ovarian cancer syndromes), or a developmental anomaly (orchietomy in those with an undescended testis). In some cases, prophylactic surgery is more radical than the surgical procedures used to treat the cancer after it develops. The assessment of risk involves many factors and should be undertaken with care before advising a patient to undergo such a major procedure. For breast cancer prevention, many experts use a 20% risk of developing breast cancer over the next 5 years as a threshold. However, patient fears play a major role in defining candidates for cancer prevention surgery. Counseling and education may not be enough to allay the fears of someone who has lost close family members to a malignancy.

## DIAGNOSIS

The underlying principle in cancer diagnosis is to obtain as much tissue as safely possible. Owing to tumor heterogeneity, pathologists are better able to make the diagnosis when they have more tissue to examine. In



**FIGURE 27-1**

**Gompertzian tumor growth.** The growth fraction of a tumor declines exponentially over time (*top*). The growth rate of a tumor peaks before it is clinically detectable (*middle*). Tumor size increases slowly, goes through an exponential phase, and slows again as the tumor reaches the size at which limitation of nutrients or auto- or host regulatory influences can occur. The maximum growth rate occurs at  $1/e$ , the point at which the tumor is  $\sim 37\%$  of its maximum size (marked with an X). Tumor becomes detectable at a burden of  $\sim 10^9$  ( $1 \text{ cm}^3$ ) cells and kills the patient at a tumor cell burden of  $\sim 10^{12}$  ( $1 \text{ kg}$ ). Efforts to treat the tumor and reduce its size can result in an increase in the growth fraction and an increase in growth rate.

addition to light-microscopic inspection of a tumor for pattern of growth, degree of cellular atypia, invasiveness, and morphologic features that aid in the differential diagnosis, sufficient tissue is of value in searching for genetic abnormalities and protein expression patterns, such as hormone receptor expression in breast cancers, that may aid in differential diagnosis or provide information about prognosis or likely response to treatment. Histologically similar tumors may have very different gene expression patterns when assessed by such techniques as microarray analysis using gene chips, with important differences in response to treatment. Such testing requires that the tissue be handled properly (e.g., immunologic detection of proteins is more effective in fresh-frozen tissue rather than in formalin-fixed tissue). Coordination among the surgeon, pathologist, and primary care physician is essential to ensure that the amount of information learned from the biopsy material is maximized.

These goals are best met by an *excisional biopsy* in which the entire tumor mass is removed with a small margin of normal tissue surrounding it. If an excisional biopsy cannot be performed, *incisional biopsy* is the procedure of second choice. A wedge of tissue is removed, and an effort is made to include most of the cross-sectional diameter of the tumor in the biopsy to minimize sampling error. The biopsy techniques that involve cutting into tumor carry with them a risk of facilitating the spread of the tumor. *Core-needle biopsy* usually obtains considerably less tissue, but this procedure often provides enough information to plan a definitive surgical procedure. *Fine-needle aspiration* generally obtains only a suspension of cells from within a mass. This procedure is minimally invasive, and if positive for cancer it may allow inception of systemic treatment when metastatic disease is evident, or it can provide a basis for planning a more meticulous and extensive surgical procedure.

## STAGING

As noted in Chap. 25, an important component of patient management is defining the extent of disease. Radiographic and other imaging tests can be helpful in defining the clinical stage; however, pathologic staging requires defining the extent of involvement by documenting the histologic presence of tumor in tissue biopsies obtained through a surgical procedure. Axillary lymph node sampling in breast cancer and lymph node sampling at laparotomy for lymphomas and testicular, colon, and other intraabdominal cancers may provide crucial information for treatment planning and may determine the extent and nature of primary cancer treatment.

## TREATMENT

Surgery is the most effective means of treating cancer. Today ~40% of cancer patients are cured by surgery.

Unfortunately, a large fraction of patients with solid tumors (perhaps 60%) have metastatic disease that is not accessible for removal. However, even when the disease is not curable by surgery alone, the removal of tumor can obtain important benefits, including local control of tumor, preservation of organ function, debulking that permits subsequent therapy to work better, and staging information on extent of involvement. Cancer surgery aiming for cure is usually planned to excise the tumor completely with an adequate margin of normal tissue (the margin varies with the tumor and the anatomy), touching the tumor as little as possible to prevent vascular and lymphatic spread, and minimizing operative risk. Extending the procedure to resect draining lymph nodes obtains prognostic information, but such resections alone generally do not improve survival.

Increasingly, laparoscopic approaches are being used to address primary abdominal and pelvic tumors. Lymph node spread may be assessed using the sentinel node approach, in which the first draining lymph node a spreading tumor would encounter is defined by injecting a dye into the tumor site at operation and then resecting the first node to turn blue. The sentinel node assessment is continuing to undergo clinical evaluation but appears to provide reliable information without the risks (lymphedema, lymphangiosarcoma) associated with resection of all the regional nodes. Advances in adjuvant chemotherapy and radiation therapy following surgery have permitted a substantial decrease in the extent of primary surgery necessary to obtain the best outcomes. Thus lumpectomy with radiation therapy is as effective as modified radical mastectomy for breast cancer, and limb-sparing surgery followed by adjuvant radiation therapy and chemotherapy has replaced radical primary surgical procedures involving amputation and disarticulation for childhood rhabdomyosarcomas. More limited surgery is also being employed to spare organ function, as in larynx and bladder cancer. The magnitude of operations necessary to optimally control and cure cancer has also been diminished by technical advances; for example, the circular anastomotic stapler has allowed narrower (<2 cm) margins in colon cancer without compromise of local control rates, and many patients who would have had colostomies are able to maintain normal anatomy.

In some settings—e.g., bulky testicular cancer or stage III breast cancer—surgery is not the first treatment modality employed. After an initial diagnostic biopsy, chemotherapy and/or radiation therapy is delivered to reduce the size of the tumor and clinically control undetected metastatic disease. Such therapy is followed by a surgical procedure to remove residual masses; this is called *neoadjuvant therapy*. Because the sequence of treatment is critical to success and is different from the standard surgery-first approach, coordination among the surgical oncologist, radiation oncologist, and medical oncologist is crucial.

Surgery may be curative in a subset of patients with metastatic disease. Patients with lung metastases from osteosarcoma may be cured by resection of the lung lesions. In patients with colon cancer who have fewer than five liver metastases restricted to one lobe and no extrahepatic metastases, hepatic lobectomy may produce long-term disease-free survival in 25% of selected patients. Surgery can also be associated with systemic antitumor effects. In the setting of hormonally responsive tumors, oophorectomy and/or adrenalectomy may control estrogen production, and orchiectomy may reduce androgen production; both have effects on metastatic tumor growth. If resection of the primary lesion takes place in the presence of metastases, acceleration of metastatic growth may occur, perhaps based on the removal of a source of angiogenesis inhibitors and mass-related growth regulators in the tumor.

In selecting a surgeon or center for primary cancer treatment, consideration must be given to the volume of cancer surgeries undertaken by the site. Studies in a variety of cancers have shown that increased annual procedure volume appears to correlate with outcome. In addition, facilities with extensive support systems—e.g., for joint thoracic and abdominal surgical teams with cardiopulmonary bypass, if needed—may allow resection of certain tumors that would otherwise not be possible.

## PALLIATION

Surgery is employed in a number of ways for supportive care: insertion of central venous catheters, control of pleural and pericardial effusions and ascites, caval interruption for recurrent pulmonary emboli, stabilization of cancer-weakened weight-bearing bones, and control of hemorrhage, among others. Surgical bypass of gastrointestinal, urinary tract, or biliary tree obstruction can alleviate symptoms and prolong survival. Surgical procedures may provide relief of otherwise intractable pain or reverse neurologic dysfunction (cord decompression). Splenectomy may relieve symptoms and reverse hypersplenism. Intrathecal or intrahepatic therapy relies on surgical placement of appropriate infusion portals. Surgery may correct other treatment-related toxicities such as adhesions or strictures.

## REHABILITATION

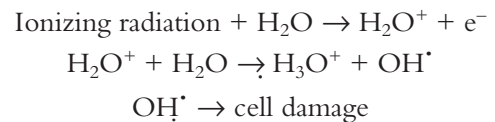
Surgical procedures are also valuable in restoring a cancer patient to full health. Orthopedic procedures may be necessary to assure proper ambulation. Breast reconstruction can make an enormous impact on the patient's perception of successful therapy. Plastic and reconstructive surgery can correct the effects of disfiguring primary treatment.

## PRINCIPLES OF RADIATION THERAPY

### PHYSICAL PROPERTIES AND BIOLOGIC EFFECTS

Exposure to ionizing radiation is constant. Radiation comes from the sun and other cosmic sources, the ground, the air we breathe, the food we ingest, and from within our bodies. Radiation therapy uses radiation to treat cancer. Radiation is a physical form of treatment that damages any tissue in its path; its selectivity for cancer cells may be due to defects in a cancer cell's ability to repair sublethal DNA and other damage. Radiation causes breaks in DNA and generates free radicals from cell water that may damage cell membranes, proteins, and organelles. Radiation damage depends on oxygen; hypoxic cells are more resistant. Augmentation of oxygen is the basis for radiation sensitization. Sulfhydryl compounds interfere with free radical generation and may act as radiation protectors.

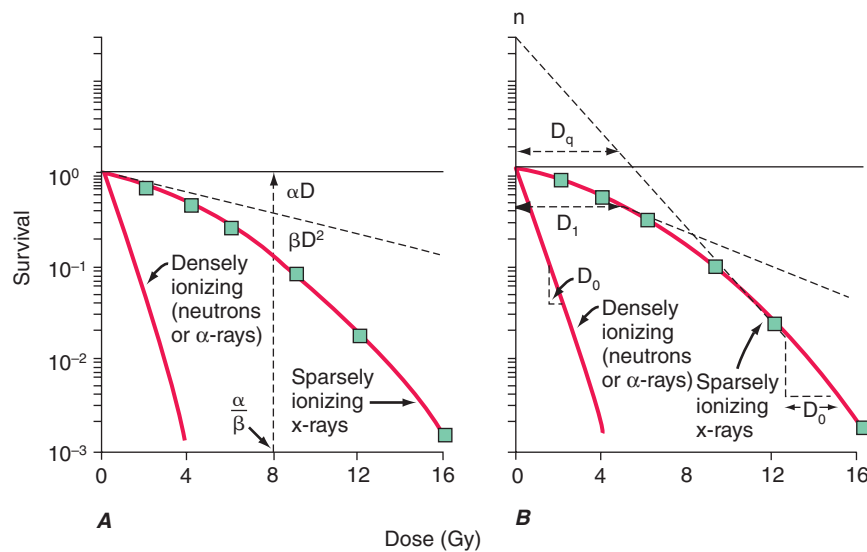
Most radiation-induced cell damage is due to the formation of hydroxyl radicals:



The dose-response curve for cells has both linear and exponential components. The linear component is from double-stranded DNA breaks produced by single hits. The exponential component represents breaks produced by multiple hits (Fig. 27-2). Plotting the fraction of surviving cells against doses of x-rays or gamma radiation, the curve has a shoulder that reflects the cell's repair of sublethal damage, followed by a linear portion reflecting greater cell kill with larger doses. The features that make a particular cell more sensitive or more resistant to the biologic effects of radiation are not completely defined.

Although radiation can interfere with many cellular processes, many experts believe that a cell must undergo a double-strand DNA break from radiation in order to be killed. The factors that influence tumor cell killing include the  $D_0$  of the tumor (the dose required to deliver an average of one lethal hit to all the cells in a population), the  $D_q$  of the tumor (the threshold dose—a measure of the cell's ability to repair sublethal damage), hypoxia, tumor mass, growth fraction, and cell cycle time and phase (cells in late  $G_1$  and S are more resistant). Rate of clinical response is not predictive; some cells do not die after radiation exposure until they attempt to replicate.

Therapeutic radiation is delivered in three ways: (1) *teletherapy*, with beams of radiation generated at a distance and aimed at the tumor within the patient; (2) *brachytherapy*, with encapsulated sources of radiation implanted directly into or adjacent to tumor tissues; and



**FIGURE 27-2**

**Shape of survival curve for mammalian cells exposed to radiation.** The fraction of cells surviving is plotted on a logarithmic scale against dose on a linear scale. For alpha particles or low-energy neutrons (said to be densely ionizing), the dose-response curve is a straight line from the origin (i.e., survival is an exponential function of dose). The survival curve can be described by just one parameter, the slope. For x-rays or gamma rays (said to be sparsely ionizing), the dose-response curve has an initial linear slope, followed by a shoulder; at higher doses the curve tends to become straight again. **A.** The experimental data are fitted to a linear-quadratic

function. There are two components of cell killing: one is proportional to dose ( $\alpha D$ ), while the other is proportional to the square of the dose ( $\beta D^2$ ). The dose at which the linear and quadratic components are equal is the ratio  $\alpha/\beta$ . The linear-quadratic curve bends continuously but is a good fit to experimental data for the first few decades of survival. **B.** The curve is described by the initial slope ( $D_1$ ), the final slope ( $D_0$ ), and a parameter that represents the width of the shoulder, either  $n$  or  $D_q$ . (From EJ Hall: *Radiobiology for the Radiologist*, 5th ed. Philadelphia, Lippincott Williams & Wilkins, 2000; with permission.)

(3) *systemic therapy*, with radionuclides targeted in some fashion to a site of tumor. Teletherapy is the most commonly used form of radiation therapy.

Radiation from any source decreases in intensity as a function of the square of the distance from the source (inverse square law). Thus, if the radiation source is 5 cm above the skin surface and the tumor is 5 cm below the skin surface, the intensity of radiation in the tumor will be  $5^2/10^2$ , or 25% of the intensity at the skin. By contrast, if the radiation source is moved to 100 cm from the patient, the intensity of radiation in the tumor will be  $100^2/105^2$ , or 91% of the intensity at the skin. Teletherapy maintains intensity over a larger volume of target tissue by increasing the source-to-surface distance. In brachytherapy, the source-to-surface distance is small; thus the effective treatment volume is small.

X-rays and gamma rays are the forms of radiation most commonly used to treat cancer. They are both electromagnetic, nonparticulate waves that cause the ejection of an orbital electron when absorbed. This orbital electron ejection is called *ionization*. X-rays are generated by linear accelerators; gamma rays are generated from decay of atomic nuclei in radioisotopes such as cobalt and radium. These waves behave biologically as packets of energy, called *photons*. Particulate forms of

radiation are also used in certain circumstances. Electron beams have a very low tissue penetrance and are used to treat skin conditions such as mycosis fungoides. Neutron beams may be somewhat more effective than x-rays in treating salivary gland tumors. However, aside from these specialized uses, particulate forms of radiation such as neutrons, protons, and negative mesons, which should do more tissue damage because of their higher linear energy transfer and be less dependent on oxygen, have not yet found wide applicability to cancer treatment.

A number of parameters influence the damage done to tissue by radiation. Hypoxic cells are relatively resistant. Nondividing cells are more resistant than dividing cells. In addition to these biologic parameters, physical parameters of the radiation are also crucial. The energy of the radiation determines its ability to penetrate tissue. Low-energy orthovoltage beams (150–400 kV) scatter when they strike the body, much like light diffuses when it strikes particles in the air. Such beams result in more damage to adjacent normal tissues and less radiation delivered to the tumor. Megavoltage radiation ( $>1$  MeV) has very low lateral scatter; this produces a skin-sparing effect, more homogeneous distribution of the radiation energy, and greater deposit of the energy in the tumor, or *target volume*. The tissues that the beam passes through

348 to get to the tumor are called the *transit volume*. The maximum dose in the target volume is often the cause of complications to tissues in the transit volume, and the minimum dose in the target volume influences the likelihood of tumor recurrence. Dose homogeneity in the target volume is the goal.

Radiation is quantitated on the basis of the amount of radiation absorbed in the patient; it is not based on the amount of radiation generated by the machine. The *rad* (radiation absorbed dose) is defined as 100 erg of energy per gram of tissue. The International System (SI) unit for rad is the Gray (Gy); 1 Gy = 100 rad. Radiation dose is measured by placing detectors at the body surface or calculating the dose based on radiating phantoms that resemble human form and substance. Radiation dose has three determinants: total absorbed dose, number of fractions, and time. A frequent error is to omit the number of fractions and the duration of treatment. This is analogous to saying that a runner completed a race in 20 s; without knowing how far he or she ran, the result is difficult to interpret. The time could be very good for a 200-m race or very poor for a 100-m race. Thus a typical course of radiation therapy should be described as 4500 cGy delivered to a particular target (e.g., mediastinum) over 5 weeks in 180-cGy fractions. Most curative radiation treatment programs are delivered once a day, 5 days a week, in 150- to 200-cGy fractions.

Compounds that incorporate into DNA and alter its stereochemistry (e.g., halogenated pyrimidines, cisplatin) augment radiation effects. Hydroxyurea, another DNA synthesis inhibitor, also potentiates radiation effects. Compounds that deplete thiols (e.g., buthionine sulfoximine) can also augment radiation effects. Hypoxia is a major factor that interferes with radiation effects.

## APPLICATION TO PATIENTS

### Teletherapy

Radiation therapy can be used alone or together with chemotherapy to produce cure of localized tumors and control of the primary site of disease in tumors that have disseminated. Therapy is planned based on the use of a simulator with the treatment field or fields designed to accommodate an individual patient's anatomic features. Individualized treatment planning employs lead shielding tailored to shape the field and limit the radiation exposure of normal tissue. Often the radiation is delivered from two or three different positions. Conformal three-dimensional treatment planning permits the delivery of higher doses of radiation to the target volume without increasing complications in the transit volume.

Radiation therapy is a component of curative therapy for a number of diseases, including breast cancer,

Hodgkin's disease, head and neck cancer, prostate cancer, and gynecologic cancers. Radiation therapy can also palliate disease symptoms in a variety of settings: relief of bone pain from metastatic disease, control of brain metastases, reversal of spinal cord compression and superior vena caval obstruction, shrinkage of painful masses, and opening of threatened airways. In high-risk settings, radiation therapy can prevent the development of leptomeningeal disease and brain metastases in acute leukemia and lung cancer.

### Brachytherapy

Brachytherapy involves placing a sealed source of radiation into or adjacent to the tumor and withdrawing the radiation source after a period of time precisely calculated to deliver a chosen dose of radiation to the tumor. This approach is often used to treat brain tumors and cervical cancer. The difficulty with brachytherapy is the short range of radiation effects (the inverse square law) and the inability to shape the radiation to fit the target volume. Normal tissue may receive toxic exposure to the radiation, with attendant radiation enteritis or cystitis in cervix cancer or brain injury in brain tumors.

### Radionuclides and Radioimmunotherapy

Nuclear medicine physicians or radiation oncologists may administer radionuclides with therapeutic effects. Iodine 131 is used to treat thyroid cancer because iodine is naturally taken up preferentially by the thyroid; it emits gamma rays that destroy the normal thyroid as well as the tumor. Strontium 89 and samarium 153 are two radionuclides that are preferentially taken up in bone, particularly sites of new bone formation. Both are capable of controlling bone metastases and the pain associated with them, but the dose-limiting toxicity is myelosuppression.

Monoclonal antibodies and other ligands can be attached to radioisotopes by conjugation (for nonmetal isotopes) or by chelation (for metal isotopes), and the targeting moiety can result in the accumulation of the radionuclide preferentially in tumor. Iodine 131-labeled anti-CD20 and yttrium 90-labeled anti-CD20 are active in B cell lymphoma, and other labeled antibodies are being evaluated. Thyroid uptake of labeled iodine is blocked by cold iodine. Dose-limiting toxicity is myelosuppression.

### Photodynamic Therapy

Some chemical structures (porphyrins, phthalocyanines) are selectively taken up by cancer cells by mechanisms not fully defined. When light, usually delivered by a laser, is shone on cells containing these compounds, free

radicals are generated and the cells die. Hematoporphyrins and light are being used with increasing frequency to treat skin cancer; ovarian cancer; and cancers of the lung, colon, rectum, and esophagus. Palliation of recurrent locally advanced disease can sometimes be dramatic and last many months.

## TOXICITY

Although radiation therapy is most often administered to a local region, systemic effects, including fatigue, anorexia, nausea, and vomiting, may develop that are related in part to the volume of tissue irradiated, dose fractionation, radiation fields, and individual susceptibility. Bone is among the most radioresistant organs, radiation effects being manifested mainly in children through premature fusion of the epiphyseal growth plate. By contrast, the male testis, female ovary, and bone marrow are the most sensitive organs. Any bone marrow in a radiation field will be eradicated by therapeutic irradiation. Organs with less need for cell renewal, such as heart, skeletal muscle, and nerves, are more resistant to radiation effects. In radiation-resistant organs, the vascular endothelium is the most sensitive component. Organs with more self-renewal as a part of normal homeostasis, such as the hematopoietic system and mucosal lining of the intestinal tract, are more sensitive. Acute toxicities include mucositis, skin erythema (ulceration in severe cases), and bone marrow toxicity. Often these can be alleviated by interruption of treatment.

Chronic toxicities are more serious. Radiation of the head and neck region often produces thyroid failure. Cataracts and retinal damage can lead to blindness. Salivary glands stop making saliva, which leads to dental caries and poor dentition. Taste and smell can be affected. Mediastinal irradiation leads to a threefold increased risk of fatal myocardial infarction. Other late vascular effects include chronic constrictive pericarditis, lung fibrosis, viscus stricture, spinal cord transection, and radiation enteritis. A serious late toxicity is the development of second solid tumors in or adjacent to the radiation fields. Such tumors can develop in any organ or tissue and occur at a rate of ~1% per year beginning in the second decade after treatment. Some organs vary in susceptibility to radiation carcinogenesis. A woman who receives mantle field radiation therapy for Hodgkin's disease at age 25 has a 30% risk of developing breast cancer by age 55 years. This is comparable in magnitude to genetic breast cancer syndromes. Women treated after age 30 have little or no increased risk of breast cancer. No data suggest that a threshold dose of therapeutic radiation exists below which the incidence of second cancers is decreased. High rates of second tumors occur in people who receive as little as 1000 cGy.

*Medical oncology* is the subspecialty of internal medicine that cares for and designs treatment approaches to patients with cancer, in conjunction with surgical and radiation oncologists. The core skills of the medical oncologist include the use of drugs that may have a beneficial effect on the natural history of the patient's illness or favorably influence the patient's quality of life. In general, the curability of a tumor is inversely related to tumor volume and directly related to drug dose.

## END POINTS OF DRUG ACTION

Chemotherapy agents may be used for the treatment of active, clinically apparent cancer. **Table 27-1, A** lists those tumors considered curable by conventionally available chemotherapeutic agents when used to address disseminated or metastatic cancers. If a tumor is localized to a single site, serious consideration of surgery or primary radiation therapy should be given because these treatment modalities may be curative as local treatments. Chemotherapy may be employed after the failure of these modalities to eradicate a local tumor or as part of multimodality approaches to offer primary treatment to a clinically localized tumor. In this event, it can allow organ preservation when given with radiation, as in the larynx or other upper airway sites; or sensitize tumors to radiation when given, for example, to patients concurrently receiving radiation for lung or cervix cancer (Table 27-1, *B*). Chemotherapy can be administered as an adjuvant, i.e., in addition to surgery (Table 27-1, *C*) or radiation, after all clinically apparent disease has been removed. This use of chemotherapy may have curative potential in breast and colorectal neoplasms because it attempts to eliminate clinically unapparent tumor that may have already disseminated. As noted earlier, small tumors frequently have high growth fractions and therefore may be intrinsically more susceptible to the action of antiproliferative agents. Chemotherapy is routinely used in "conventional" dose regimens. In general, these doses produce reversible acute side effects, primarily consisting of transient myelosuppression with or without gastrointestinal toxicity (usually nausea), which are readily managed. High-dose chemotherapy regimens are predicated on the observation that the dose-response curve for many anticancer agents is rather steep, and increased dose can produce markedly increased therapeutic effect, although at the cost of potentially life-threatening complications that require intensive support, usually in the form of hematopoietic stem cell support from the patient (*autologous*) or from donors matched for histocompatibility loci (*allogeneic*). High-dose regimens have definite curative potential in defined clinical settings (Table 27-1, *D*).

**CURABILITY OF CANCERS WITH CHEMOTHERAPY****A. Advanced cancers with possible cure**

Acute lymphoid and acute myeloid leukemia (pediatric/adult)  
 Hodgkin's disease (pediatric/adult)  
 Lymphomas—certain types (pediatric/adult)  
 Germ cell neoplasms  
   Embryonal carcinoma  
   Teratocarcinoma  
   Seminoma or dysgerminoma  
   Choriocarcinoma  
 Gestational trophoblastic neoplasia  
 Pediatric neoplasms  
   Wilms' tumor  
   Embryonal rhabdomyosarcoma  
   Ewing's sarcoma  
   Peripheral neuroepithelioma  
   Neuroblastoma  
 Small-cell lung carcinoma  
 Ovarian carcinoma

**B. Advanced cancers possibly cured by chemotherapy and radiation**

Squamous carcinoma (head and neck)  
 Squamous carcinoma (anus)  
 Breast carcinoma  
 Carcinoma of the uterine cervix  
 Non-small cell lung carcinoma (stage III)  
 Small-cell lung carcinoma

**C. Cancers possibly cured with chemotherapy as adjuvant to surgery**

Breast carcinoma  
 Colorectal carcinoma<sup>a</sup>  
 Osteogenic sarcoma  
 Soft tissue sarcoma

**D. Cancers possibly cured with "high-dose" chemotherapy with stem cell support**

Relapsed leukemias, lymphoid and myeloid  
 Relapsed lymphomas, Hodgkin's and non-Hodgkin's  
 Chronic myeloid leukemia  
 Multiple myeloma

**E. Cancers responsive with useful palliation, but not cure, by chemotherapy**

Bladder carcinoma  
 Chronic myeloid leukemia  
 Hairy cell leukemia  
 Chronic lymphocytic leukemia  
 Lymphoma—certain types  
 Multiple myeloma  
 Gastric carcinoma  
 Cervix carcinoma  
 Endometrial carcinoma  
 Soft tissue sarcoma  
 Head and neck cancer  
 Adrenocortical carcinoma  
 Islet-cell neoplasms  
 Breast carcinoma  
 Colorectal carcinoma  
 Renal carcinoma

**F. Tumor poorly responsive in advanced stages to chemotherapy**

Pancreatic carcinoma  
 Biliary-tract neoplasms  
 Thyroid carcinoma  
 Carcinoma of the vulva  
 Non-small cell lung carcinoma  
 Prostate carcinoma  
 Melanoma  
 Hepatocellular carcinoma

<sup>a</sup>Rectum also receives radiation therapy.

Karnofsky was among the first to champion the evaluation of a chemotherapeutic agent's benefit by carefully quantitating its effect on tumor size and using these measurements to objectively decide the basis for further treatment of a particular patient or further clinical evaluation of a drug's potential. A partial response (PR) is defined conventionally as a decrease by at least 50% in a tumor's bidimensional area; a complete response (CR) connotes disappearance of all tumor; progression of disease signifies an increase in size of existing lesions by >25% from baseline or best response or development of new lesions; and "stable" disease fits into none of the preceding categories. Newer evaluation systems use unidimensional measurement, but the intent is similar in rigorously defining evidence for the activity of the agent in assessing its value to the patient.

If cure is not possible, chemotherapy may be undertaken with the goal of palliating some aspect of the

tumor's effect on the host. Common tumors that may be meaningfully addressed with palliative intent are listed in Table 27-1, E. Usually, tumor-related symptoms may manifest as pain, weight loss, or some local symptom related to the tumor's effect on normal structures. Patients treated with palliative intent should be aware of their diagnosis and the limitations of the proposed treatments, have access to supportive care, and have suitable "performance status," according to assessment algorithms such as the one developed by Karnofsky or by the Eastern Cooperative Oncology Group (ECOG). ECOG performance status 0 (PS0) patients are without symptoms; PS1 patients are ambulatory but restricted in strenuous physical activity; PS2 patients are ambulatory but unable to work and are up and about  $\geq 50\%$  of the time; PS3 patients are capable of limited self-care and are up <50% of the time; PS4 patients are totally confined to bed or chair and incapable of self-care. Only PS0, PS1, and PS2 patients are generally

considered suitable for palliative (noncurative) treatment. If there is curative potential, even poor-performance status patients may be treated, but their prognosis is usually inferior to that of good-performance patients treated with similar regimens.

An important perspective the primary care provider may bring to patients and their families facing incurable cancer is that, given the limited value of chemotherapeutic approaches at some point in the natural history, *palliative care* or *hospice-based* approaches, with meticulous and ongoing attention to symptom relief and with family, psychological, and spiritual support, should receive prominent attention as a valuable therapeutic plan (Chap. 30). Optimizing the quality of life rather than attempting to extend it becomes a valued intervention. Patients facing the impending progression of disease in a life-threatening way frequently choose to undertake toxic treatments of little to no potential value, and support provided by the primary caregiver in accessing palliative and hospice-based options can be critical in providing a basis for patients to make sensible choices.

## CANCER DRUGS: OVERVIEW AND PRINCIPLES FOR USE

Cancer drug treatments are of four broad types. *Conventional chemotherapy agents* were historically derived by the empirical observation that these “small molecules” (generally with molecular weight <1500 Da) could cause major regression of experimental tumors growing in animals. These agents mainly target DNA structure or segregation of DNA as chromosomes in mitosis. *Targeted agents* refer to small molecules or “biologicals” (generally macromolecules such as antibodies or cytokines) designed and developed to interact with a defined molecular target important in either maintaining the malignant state or selectively expressed by the tumor cells. As described in Chap. 24, successful tumors have activated biochemical pathways that lead to uncontrolled proliferation through the action of, e.g., oncogene products, loss of cell cycle inhibitors, or loss of cell death regulation, and have acquired the capacity to replicate chromosomes indefinitely, invade, metastasize, and evade the immune system. Targeted therapies seek to capitalize on the biology behind the aberrant cellular behavior as a basis for therapeutic effects. *Hormonal therapies* (the first form of targeted therapy) capitalize on the biochemical pathways underlying estrogen and androgen function and action as a therapeutic basis for approaching patients with tumors of breast, prostate, uterus, and ovarian origin. *Biologic therapies* are often macromolecules that have a particular target (e.g., antiproliferative factor or cytokine antibodies) or may have the capacity to orchestrate or regulate the host immune response to kill tumor cells.

Thus biologic therapies include not only antibodies but cytokines and gene therapies.

The usefulness of any drug is governed by the extent to which a given dose causes a useful result (therapeutic effect; in the case of anticancer agents, toxicity to tumor cells) as opposed to a toxic effect. The *therapeutic index* is the degree of separation between toxic and therapeutic doses. Really useful drugs have large therapeutic indices, and this usually occurs when the drug target is expressed in the disease-causing compartment as opposed to the normal compartment. Classically, selective toxicity of an agent for an organ is governed by the expression of an agent’s target or by differential accumulation into or elimination from compartments where toxicity is experienced or ameliorated, respectively. Currently used chemotherapeutic agents have the unfortunate property that their targets are present in both normal and tumor tissues. Therefore, they have relatively narrow therapeutic indices.

Following demonstration of activity in animal models, conventional chemotherapeutic agents are further evaluated to define an optimal schedule of administration and arrive at a drug formulation designed for a given route and schedule. Safety testing in two species on an analogous schedule of administration defines the starting dose for a phase I trial in humans. This is established as a fraction, usually one-sixth to one-tenth, of the dose just causing easily reversible toxicity in the more sensitive animal species. Escalating doses of the drug are then given during the human phase I trial until reversible toxicity is observed. Dose-limiting toxicity (DLT) defines a dose that conveys greater toxicity than would be acceptable in routine practice, allowing definition of a lower maximal tolerated dose (MTD). The occurrence of toxicity, if possible, is correlated with plasma drug concentrations. The MTD or a dose just lower than the MTD is usually the dose suitable for phase II trials, where a fixed dose is administered to a relatively homogeneous set of patients with a particular tumor type in an effort to define whether the drug causes regression of tumors. An “active” agent conventionally has PR rates of at least 20–25% with reversible non-life-threatening side effects, and it may then be suitable for study in phase III trials to assess efficacy in comparison to standard or no therapy.

Response, defined as tumor shrinkage, is but the most immediate indicator of drug effect. To be clinically valuable, responses must translate into clinical benefit. This is conventionally established by a beneficial effect on overall survival, or at least an increased time to further progression of disease. Active efforts are being made to quantitate effects of anticancer agents on quality of life. Cancer drug clinical trials conventionally use a toxicity grading scale where grade I toxicities do not require treatment, grade II often require symptomatic treatment



352 but are not life-threatening, grade III toxicities are potentially life-threatening if untreated, grade IV toxicities are actually life-threatening, and grade V toxicities are those that result in the patient's death.

Development of targeted agents should proceed quite differently. Although Phase I to III trials are still conducted, molecular analysis of human tumors more precisely defines targets expressed in a patient's tumor and should allow patient selection to enrich all trial phases with patients potentially responsive to the agent by virtue of expressing the target in the tumor. Clinical trials may be designed that assess the behavior of the drug in relation to its target. Ideally, the plasma concentration that affects the drug target is known, so escalation to MTD may not be necessary. Rather, the correlation of host toxicity while achieving an "optimal biologic dose" becomes a more relevant end point for Phase I and early Phase II trials with targeted agents.

Valuable cancer drug treatment strategies using conventional chemotherapy agents, targeted agents, hormonal treatments, or biologicals have one of two valuable outcomes. They can induce cancer cell death, resulting in tumor shrinkage with corresponding improvement in patient survival, or increase the time until the disease progresses. Another potential outcome is to induce cancer cell *differentiation* or dormancy with loss of tumor cell replicative potential and reacquisition of phenotypic properties resembling normal cells. Blocking tumor cell differentiation may be a key feature in the pathogenesis of certain leukemias.

Cell death is a closely regulated process. *Necrosis* refers to cell death induced, for example, by physical damage with the hallmarks of cell swelling and membrane disruption. *Apoptosis*, or programmed cell death, refers to a highly ordered process whereby cells respond to defined stimuli by dying, and it recapitulates the necessary cell death observed during the ontogeny of the organism. *Anoikis* refers to the death of epithelial cells after removal from the normal milieu of substrate, particularly from cell-to-cell contact. Cancer chemotherapeutic agents can cause both necrosis and apoptosis. Apoptosis is characterized by chromatin condensation (giving rise to "apoptotic bodies"), cell shrinkage, and, in living animals, phagocytosis by surrounding stromal cells without evidence of inflammation. This process is regulated either by signal transduction systems that promote a cell's demise after a certain level of insult is achieved, or in response to specific cell-surface receptors that mediate cell death signals. Modulation of apoptosis by manipulation of signal transduction pathways has emerged as a basis for understanding the actions of drugs and designing new strategies to improve their use.

A general view of how cancer treatments work is that the interaction of a chemotherapeutic drug with its

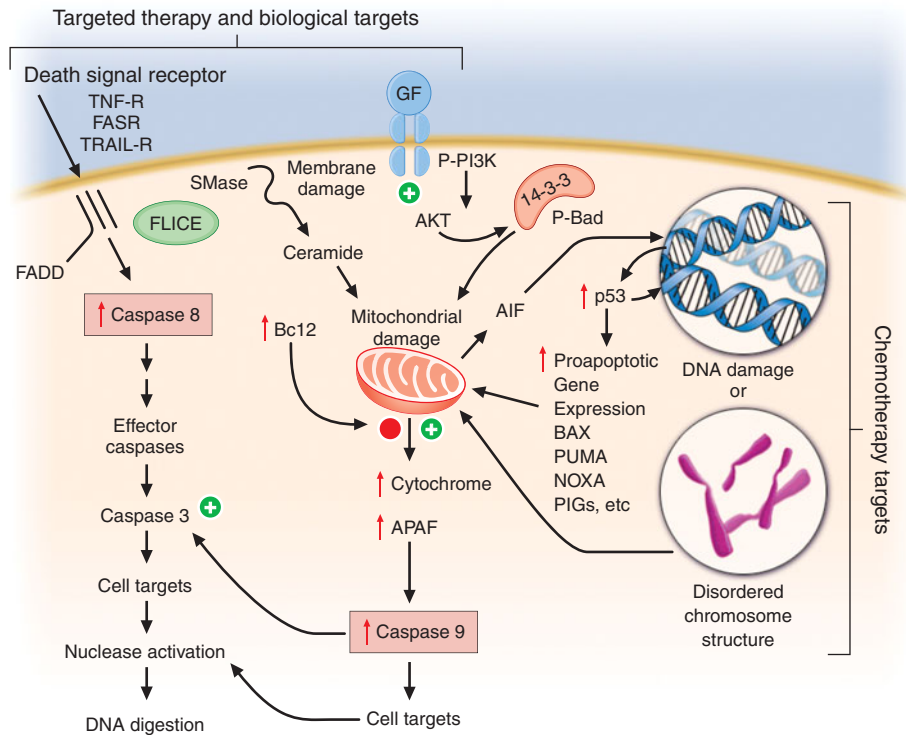
target induces a "cascade" of further signaling steps. These signals ultimately lead to cell death by triggering an "execution phase" where proteases, nucleases, and endogenous regulators of the cell death pathway are activated (Fig. 27-3).

Targeted agents differ from chemotherapy agents in that they do not indiscriminately cause macromolecular lesions but regulate the action of particular pathways. For example, the p210<sup>bcr-abl</sup> fusion protein tyrosine kinase drives chronic myeloid leukemia (CML), and HER-2/neu stimulates the proliferation of certain breast cancers. The tumor has been described as "addicted" to the function of these molecules in the sense that without the pathway's continued action, the tumor cell cannot survive. In this way, targeted agents may alter the "threshold" tumors have for undergoing apoptosis without actually creating any molecular lesions such as direct DNA strand breakage or altered membrane function.

Although apoptotic mechanisms are important in regulating cellular proliferation and the behavior of tumor cells *in vitro*, *in vivo* it is unclear whether all of the actions of chemotherapeutic agents to cause cell death can be attributed to apoptotic mechanisms. However, changes in molecules that regulate apoptosis are correlated with clinical outcomes (e.g., *bcl2* overexpression in certain lymphomas conveys poor prognosis; pro-apoptotic *bax* expression is associated with a better outcome after chemotherapy for ovarian carcinoma). A better understanding of the relationship of cell death and cell survival mechanisms is needed.

Resistance to chemotherapy drugs has been postulated to arise either from cells not being in the appropriate phase of the cell cycle to allow drug lethality, or from decreased uptake, increased efflux, metabolism of the drug, or alteration of the target, e.g., by mutation or overexpression. Indeed, p170PGP (p170 P-glycoprotein; *mdr* gene product) was recognized from experiments with cells growing in tissue culture as mediating the efflux of chemotherapeutic agents in resistant cells. Certain neoplasms, particularly hematopoietic tumors, have an adverse prognosis if they express high levels of p170PGP, and modulation of this protein's function has been attempted by a variety of strategies.

Chemotherapeutic agents where drugs acting by different mechanisms were combined (e.g., an alkylating agent plus an antimetabolite plus a mitotic spindle blocker) proved to be more effective than single agents. Particular combinations were chosen to emphasize drugs whose individual toxicities to the host were, if possible, distinct. As agents emerge with novel mechanisms of action, combinations of drugs and targeted agents may maximize the chances of affecting critical pathways in the tumor.



**FIGURE 27-3**

**Integration of cell death responses.** Cell death through an apoptotic mechanism requires active participation of the cell. In response to interruption of growth factor (GF) or propagation of certain cytokine death signals (e.g., tumor necrosis factor receptor, TNF-R), there is activation of “upstream” cysteine aspartyl proteases (caspases), which then directly digest cytoplasmic and nuclear proteins, resulting in activation of “downstream” caspases; these cause activation of nucleases, resulting in the characteristic DNA fragmentation that is a hallmark of apoptosis. Chemotherapy agents that create lesions in DNA or alter mitotic spindle function seem to activate aspects of this process by damage ultimately conveyed to the mitochondria, perhaps by activating the transcription of genes whose products can produce or modulate the toxicity of free radicals. In addition, membrane damage with activation of sphingomyelinases results in the production of ceramides that can have a direct action at

mitochondria. The antiapoptotic protein *bcl2* attenuates mitochondrial toxicity while proapoptotic gene products such as *bax* antagonize the action of *bcl2*. Damaged mitochondria release cytochrome C and apoptosis-activating factor (APAF), which can directly activate caspase 9, resulting in propagation of a direct signal to other downstream caspases through protease activation. Apoptosis-inducing factor (AIF) is also released from the mitochondrion and then can translocate to the nucleus, bind to DNA, and generate free radicals to further damage DNA. An additional proapoptotic stimulus is the *bad* protein, which can heterodimerize with *bcl2* gene family members to antagonize apoptosis. Importantly, though, *bad* protein function can be retarded by its sequestration as phospho-*bad* through the 14-3-3 adapter proteins. The phosphorylation of *bad* is mediated by the action of the AKT kinase in a way that defines how growth factors that activate this kinase can retard apoptosis and promote cell survival.

## CHEMOTHERAPEUTIC AGENTS USED FOR CANCER TREATMENT

**Table 27-2** lists commonly used cancer chemotherapy agents and pertinent clinical aspects of their use. The drugs and schedules listed are examples that have proved tolerable and useful; the specific doses that may be used in a particular patient may vary somewhat with the particular treatment protocol, or plan, of treatment. Significant variation from these dose ranges should be carefully verified to avoid or anticipate toxicity. Not included in Table 27-2 are hormone receptor-directed agents because the side effects are generally those expected from the interruption or augmentation of hormonal

effect, and doses used in most cases are those that adequately saturate the intended hormone receptor. The drugs listed may be usefully grouped into three general categories: those affecting DNA, those affecting microtubules, and molecularly targeted agents.

### Direct DNA-Interactive Agents

DNA replication occurs during the synthesis or S-phase of the cell cycle, with chromosome segregation of the replicated DNA occurring in the M, or mitosis, phase. The G1 and G2 “gap phases” precede S and M, respectively. Historically, chemotherapeutic agents have been divided into “phase-nonspecific” agents, which can act

**COMMONLY USED CANCER CHEMOTHERAPY AGENTS**

DRUG	EXAMPLES OF USUAL DOSES	TOXICITY	INTERACTIONS, ISSUES
<b>Direct DNA-Interacting Agents</b>			
<b>Alkylators</b>			
Cyclophosphamide	400–2000 mg/m <sup>2</sup> IV 100 mg/m <sup>2</sup> PO qd	Marrow (relative platelet sparing) Cystitis Common alkylator <sup>a</sup> Cardiac (high dose)	Liver metabolism required to activate to phosphoramidate mustard + acrolein Mesna protects against “high-dose” bladder damage
Mechlorethamine	6 mg/m <sup>2</sup> IV day 1 and day 8	Marrow Vesicant Nausea	Topical use in cutaneous lymphoma
Chlorambucil	1–3 mg/m <sup>2</sup> qd PO	Marrow Common alkylator <sup>a</sup>	
Melphalan	8 mg/m <sup>2</sup> qd × 5, PO	Marrow (delayed nadir) GI (high dose)	Decreased renal function delays clearance
Carmustine (BCNU)	200 mg/m <sup>2</sup> IV 150 mg/m <sup>2</sup> PO	Marrow (delayed nadir) GI, liver (high dose) Renal	
Lomustine (CCNU) Ifosfamide	100–300 mg/m <sup>2</sup> PO 1.2 g/m <sup>2</sup> per day qd × 5 + mesna	Marrow (delayed nadir) Myelosuppressive  Bladder Neurologic Metabolic acidosis Neuropathy	Isomeric analogue of cyclophosphamide More lipid soluble Greater activity vs testicular neoplasms and sarcomas Must use mesna
Procarbazine	100 mg/m <sup>2</sup> per day qd × 14	Marrow Nausea Neurologic Common alkylator <sup>a</sup>	Liver and tissue metabolism required Disulfiram-like effect with ethanol Acts as MAOI HBP after tyrosinase-rich foods Metabolic activation
Dacarbazine (DTIC)	375 mg/m <sup>2</sup> IV day 1 and day 15	Marrow Nausea Flulike	
Temozolomide	150–200 mg/m <sup>2</sup> qd × 5 q28d <i>or</i> 75 mg/m <sup>2</sup> qd × 6–7 weeks	Nausea/vomiting Headache/fatigue Constipation	Infrequent myelosuppression
Altretamine (formerly hexamethylmelamine)	260 mg/m <sup>2</sup> per day qd × 14–21 as 4 divided oral doses	Nausea Neurologic (mood swing) Neuropathy Marrow (less)	Liver activation Barbiturates enhance/ cimetidine diminishes
Cisplatin	20 mg/m <sup>2</sup> qd × 5 IV 1 q3–4 weeks <i>or</i> 100–200 mg/m <sup>2</sup> per dose IV q3–4 weeks	Nausea Neuropathy Auditory Marrow platelets >WBCs Renal Mg <sup>2+</sup> , Ca <sup>2+</sup>	Maintain high urine flow; osmotic diuresis, monitor intake/output K <sup>+</sup> , Mg <sup>2+</sup> Emetogenic—prophylaxis needed Full dose if CrCl >60 mL/min and tolerate fluid push
Carboplatin	365 mg/m <sup>2</sup> IV q3–4 weeks as adjusted for CrCl	Marrow platelets >WBCs Nausea Renal (high dose)	Reduce dose according to CrCl: to AUC of 5–7 mg/mL per min [AUC = dose/(CrCl + 25)]
Oxaliplatin	130 mg/m <sup>2</sup> q3 weeks over 2 h <i>or</i> 85 mg/m <sup>2</sup> q2 weeks	Nausea Anemia	Acute reversible neurotoxicity; chronic sensory neurotoxin cumulative with dose; reversible laryngopharyngeal spasm

(Continued)

TABLE 27-2 (CONTINUED)

COMMONLY USED CANCER CHEMOTHERAPY AGENTS			
DRUG	EXAMPLES OF USUAL DOSES	TOXICITY	INTERACTIONS, ISSUES
<b>Antitumor antibiotics</b>			
Bleomycin	15–25 mg/d qd × 5 IV bolus or continuous IV	Pulmonary Skin effects Raynaud's Hypersensitivity	Inactivate by bleomycin hydrolase (decreased in lung/skin) O <sub>2</sub> enhances pulmonary toxicity Cisplatin-induced decrease in CrCl may increase skin/lung toxicity Reduce dose if CrCl <60 mL/min Radiation recall
Actinomycin D	10–15 µg/kg per day qd × 5 IV bolus	Marrow Nausea Mucositis Vesicant Alopecia	
Mitomycin C	6–10 mg/m <sup>2</sup> q6 weeks	Marrow Vesicant Hemolytic-uremic syndrome Lung CV—heart failure	Treat superficial bladder cancers by intravesical infusion Delayed marrow toxicity Cumulative marrow toxicity
Etoposide (VP16-213)	100–150 mg/m <sup>2</sup> IV qd × 3–5d or 50 mg/m <sup>2</sup> PO qd × 21d or up to 1500 mg/m <sup>2</sup> per dose (high dose with stem cell support)	Marrow (WBCs > platelet) Alopecia Hypotension Hypersensitivity (rapid IV) Nausea Mucositis (high dose)	Hepatic metabolism—renal 30% Reduce doses with renal failure Schedule-dependent (5 day better than 1 day) Late leukemogenic Accentuate antimetabolite action
Topotecan	20 mg/m <sup>2</sup> IV q3–4 weeks over 30 min or 1.5–3 mg/m <sup>2</sup> q3–4 weeks over 24 h or 0.5 mg/m <sup>2</sup> per day over 21 days	Marrow Mucositis Nausea Mild alopecia	Reduce dose with renal failure No liver toxicity
Irinotecan (CPT II)	100–150 mg/m <sup>2</sup> IV over 90 min q3–4 weeks or 30 mg/m <sup>2</sup> per day over 120 h	Diarrhea: “early onset” with cramping, flushing, vomiting; “late onset” after several doses Marrow Alopecia Nausea Vomiting Pulmonary	Prodrug requires enzymatic clearance to active drug “SN 38” Early diarrhea likely due to biliary excretion Late diarrhea, use “high-dose” loperamide (2 mg q2–4 h)
Doxorubicin and daunorubicin	45–60 mg/m <sup>2</sup> dose q3–4 weeks or 10–30 mg/m <sup>2</sup> dose q week or continuous-infusion regimen	Marrow Mucositis Alopecia Cardiovascular acute/chronic Vesicant	Heparin aggregate; coadministration increases clearance Acetaminophen, BCNU increase liver toxicity Radiation recall
Idarubicin	10–15 mg/m <sup>2</sup> IV q 3 weeks or 10 mg/m <sup>2</sup> IV qd × 3	Marrow Cardiac (less than doxorubicin)	None established
Epirubicin	150 mg/m <sup>2</sup> IV q3 weeks	Marrow Cardiac	None established
Mitoxantrone	12 mg/m <sup>2</sup> qd × 3 or 12–14 mg/m <sup>2</sup> q3 weeks	Marrow Cardiac (less than doxorubicin) Vesicant (mild) Blue urine, sclerae, nails	Interacts with heparin Less alopecia, nausea than doxorubicin Radiation recall

(Continued)

## COMMONLY USED CANCER CHEMOTHERAPY AGENTS

DRUG	EXAMPLES OF USUAL DOSES	TOXICITY	INTERACTIONS, ISSUES
<b>Indirect DNA-Interacting Agents</b>			
<b>Antimetabolites</b>			
Deoxycoformycin	4 mg/m <sup>2</sup> IV every other week	Nausea Immunosuppression Neurologic Renal	Excretes in urine Reduce dose for renal failure Inhibits adenosine deaminase
6-Mercaptopurine	75 mg/m <sup>2</sup> PO or up 500 mg/m <sup>2</sup> PO (high dose)	Renal Marrow Liver Nausea	Variable bioavailability Metabolize by xanthine oxidase Decrease dose with allopurinol Increased toxicity with thiopurine methyltransferase deficiency
6-Thioguanine	2–3 mg/kg per day for up to 3–4 weeks	Marrow Liver Nausea	Variable bioavailability Increased toxicity with thiopurine methyltransferase deficiency
Azathioprine	1–5 mg/kg per day	Marrow Nausea Liver	Metabolizes to 6MP, therefore reduce dose with allopurinol Increased toxicity with thiopurine methyltransferase deficiency
2-Chlorodeoxyadenosine	0.09 mg/kg per day qd × 7 as continuous infusion	Marrow Renal Fever	Notable use in hairy cell leukemia
Hydroxyurea	20–50 mg/kg (lean body weight) PO qd or 1–3 g/d	Marrow Nausea Mucositis Skin changes Rare renal, liver, lung, CNS	Decrease dose with renal failure Augments antimetabolite effect
Methotrexate	15–30 mg PO or IM qd × 3–5 or 30 mg IV days 1 and 8 or 1.5–12 g/m <sup>2</sup> per day (with leucovorin)	Marrow Liver/lung Renal tubular Mucositis	Rescue with leucovorin Excreted in urine Decrease dose in renal failure NSAIDs increase renal toxicity
5-Fluorouracil	375 mg/m <sup>2</sup> IV qd × 5 or 600 mg/m <sup>2</sup> IV days 1 and 8	Marrow Mucositis Neurologic Skin changes	Toxicity enhanced by leucovorin Dihydropyrimidine dehydrogenase deficiency increases toxicity Metabolizes in tissues
Capecitabine	665 mg/m <sup>2</sup> bid continuous; 1250 mg/m <sup>2</sup> bid 2 weeks on/ 1 off; 829 mg/m <sup>2</sup> bid 2 weeks on/1 off + 60 mg/d leucovorin	Diarrhea Hand-foot syndrome	Prodrug of 5FU due to intratumoral metabolism
Cytosine arabinoside	100 mg/m <sup>2</sup> per day qd × 7 by continuous infusion or 1–3 g/m <sup>2</sup> dose IV bolus	Marrow Mucositis Neurologic (high dose) Conjunctivitis (high dose) Noncardiogenic pulmonary edema	Enhances activity of alkylating agents Metabolizes in tissues by deamination
Azacitidine	750 mg/m <sup>2</sup> per week or 150–200 mg/m <sup>2</sup> per day × 5–10 (bolus) or (continuous IV)	Marrow Nausea Liver Neurologic Myalgia	Use limited to leukemia Altered methylation of DNA alters gene expression
Gemcitabine	1000 mg/m <sup>2</sup> IV weekly × 7	Marrow Nausea Hepatic Fever/“flu syndrome”	

(Continued)

TABLE 27-2 (CONTINUED)

COMMONLY USED CANCER CHEMOTHERAPY AGENTS			
DRUG	EXAMPLES OF USUAL DOSES	TOXICITY	INTERACTIONS, ISSUES
Fludarabine phosphate	25 mg/m <sup>2</sup> IV qd × 5	Marrow Neurologic Lung	Dose reduction with renal failure Metabolized to F-ara converted to F-ara ATP in cells by deoxycytidine kinase Blocks methotrexate action
Asparaginase	25,000 IU/m <sup>2</sup> q3–4 weeks or 6000 IU/m <sup>2</sup> per day qod for 3–4 weeks or 1000–2000 IU/m <sup>2</sup> for 10–20 days	Protein synthesis Clotting factors Glucose Albumin Hypersensitivity CNS Pancreatitis Hepatic	
Pemetrexed	200 mg/m <sup>2</sup> q3 weeks	Anemia Neutropenia Thrombocytopenia	Supplement folate/B <sub>12</sub> Caution in renal failure
<b>Antimitotic agents</b>			
Vincristine	1–1.4 mg/m <sup>2</sup> per week	Vesicant Marrow Neurologic GI: ileus/constipation; bladder hypotonicity; SIADH Cardiovascular	Hepatic clearance Dose reduction for bilirubin >1.5 mg/dL Prophylactic bowel regimen
Vinblastine	6–8 mg/m <sup>2</sup> per week	Vesicant Marrow Neurologic (less common but similar spectrum to other vincas) Hypertension Raynaud's	Hepatic clearance Dose reduction as with vincristine
Vinorelbine	15–30 mg/m <sup>2</sup> per week	Vesicant Marrow Allergic/bronchospasm (immediate) Dyspnea/cough (subacute) Neurologic (less prominent but similar spectrum to other vincas)	Hepatic clearance
Paclitaxel	135–175 mg/m <sup>2</sup> per 24-h infusion or 175 mg/m <sup>2</sup> per 3-h infusion or 140 mg/m <sup>2</sup> per 96-h infusion or 250 mg/m <sup>2</sup> per 24-h infusion plus G-CSF	Hypersensitivity Marrow Mucositis Alopecia Sensory neuropathy CV conduction disturbance	Premedicate with steroids, H <sub>1</sub> and H <sub>2</sub> blockers Hepatic clearance Dose reduction as with vincas
Docetaxel	100 mg/m <sup>2</sup> per 1-h infusion q3 weeks	Nausea—infrequent Hypersensitivity Fluid retention syndrome Marrow Dermatologic Sensory neuropathy Nausea infrequent Some stomatitis	Premedicate with steroids, H <sub>1</sub> and H <sub>2</sub> blockers

(Continued)

## COMMONLY USED CANCER CHEMOTHERAPY AGENTS

DRUG	EXAMPLES OF USUAL DOSES	TOXICITY	INTERACTIONS, ISSUES
Estramustine phosphate	14 mg/kg per day in 3–4 divided doses with water >2 h after meals Avoid Ca <sup>2+</sup> -rich foods	Nausea Vomiting Diarrhea CHF Thrombosis Gynecomastia	
NAB-Paclitaxel (protein bound)	260 mg/m <sup>2</sup> q3 weeks	Neuropathy Anemia Neutropenia Thrombocytopenia	Caution in hepatic insufficiency
<b>Molecularly Targeted Agents</b>			
Imatinib	400 mg/d, continuous	Nausea Periorbital edema	Myelosuppression not frequent in solid tumor indications
Tretinoin	45 mg/m <sup>2</sup> per day until complete response + anthracycline-based regimen in APL	Teratogenic Cutaneous	APL differentiation syndrome: pulmonary dysfunction/infiltrate, pleural/pericardial effusion, fever
Bexarotene	300–400 mg/m <sup>2</sup> per day, continuous	Hypercholesterolemia Hypertriglyceridemia Cutaneous Teratogenic	Central hypothyroidism
Gemtuzumab ozogamicin	9 mg/m <sup>2</sup> over 2 h q2 weeks, usually followed by chemotherapy or marrow transplant	Neutropenia Thrombocytopenia Hepatic	Postinfusion syndrome: fever, chills, hypotension Rare hepatic venoocclusive disease Mucositis uncommon
Denileukin diftitox	9–18 µg/kg per day × 5 d q 3 wk	Nausea/vomiting Chills/fever Asthenia Hepatic	Acute hypersensitivity: hypotension, vasodilation, rash, chest tightness Vascular leak: hypotension, edema, hypoalbuminemia, thrombotic events (MI, DVT, CVA)
Gefitinib	250 mg PO per day	Rash Diarrhea	In U.S., only with prior documented benefit
Erlotinib	150 mg PO per day	Rash Diarrhea	1 h before, 2 h after meals
Dasatinib	70 mg PO bid	Liver changes Rash Neutropenia Thrombocytopenia	
Sorafenib	400 mg PO bid	Diarrhea Hand-foot syndrome Other rash	
Sunitinib	50 mg PO qd for 4 of 6 weeks	Fatigue Diarrhea Neutropenia	
<b>Miscellaneous</b>			
Arsenic trioxide	0.16 mg/kg per day up to 50 days in APL	↑QT <sub>c</sub> Peripheral neuropathy Musculoskeletal pain Hyperglycemia	APL differentiation syndrome (see under tretinoin)

<sup>a</sup>Common alkylator: alopecia, pulmonary, infertility, plus teratogenesis.

**Note:** APL, acute promyelocytic leukemia; AUC, area under the curve; CHF, congestive heart failure; CNS, central nervous system; CrCl, creatinine clearance; CV, cardiovascular; CVA, cerebrovascular accident; DVT, deep venous thrombosis; G-CSF, granulocyte colony-stimulating factor; GI, gastrointestinal; HBP, high blood pressure; MAOI, monoamine oxidase inhibitors; MI, myocardial infarction; 6MP, 6-mercaptopurine; NSAIDs, nonsteroidal anti-inflammatory drugs; SIADH, syndrome of inappropriate antidiuretic hormone; WBCs, white blood cells.

in any phase of the cell cycle, and “phase-specific” agents, which require the cell to be at a particular cell cycle phase to cause greatest effect. Once the agent has acted, cells may progress to “checkpoints” in the cell cycle where the drug-related damage may be assessed and either repaired or allowed to initiate apoptosis. An important function of certain tumor-suppressor genes such as p53 may be to modulate checkpoint function.

### Formation of Covalent DNA Adducts

Alkylating agents as a class are cell cycle phase-nonspecific agents. They break down, either spontaneously or after normal organ or tumor cell metabolism, to reactive intermediates that covalently modify bases in DNA. This leads to cross-linkage of DNA strands or the appearance of breaks in DNA as a result of repair efforts. “Broken” or cross-linked DNA is intrinsically unable to complete normal replication or cell division; in addition, it is a potent activator of cell cycle checkpoints and further activates cell-signaling pathways that can precipitate apoptosis. As a class, alkylating agents share similar toxicities: myelosuppression, alopecia, gonadal dysfunction, mucositis, and pulmonary fibrosis. They differ greatly in a spectrum of normal organ toxicities. As a class they share the capacity to cause “second” neoplasms, particularly leukemia, many years after use, particularly when used in low doses for protracted periods.

Cyclophosphamide is inactive unless metabolized by the liver to 4-hydroxy-cyclophosphamide, which decomposes into an alkylating species, as well as to chloroacetaldehyde and acrolein. The latter causes chemical cystitis; therefore, excellent hydration must be maintained while using cyclophosphamide. If severe, the cystitis may be effectively treated by mesna (2-mercaptoethanesulfonate). Liver disease impairs drug activation. Sporadic interstitial pneumonitis leading to pulmonary fibrosis can accompany the use of cyclophosphamide, and high doses used in conditioning regimens for bone marrow transplant can cause cardiac dysfunction. Ifosfamide is a cyclophosphamide analogue also activated in the liver, but more slowly, and it requires coadministration of mesna to prevent bladder injury. Central nervous system (CNS) effects, including somnolence, confusion, and psychosis, can follow ifosfamide use; the incidence appears related to low body surface area or the presence of nephrectomy.

Several alkylating agents are less commonly used. Nitrogen mustard (mechlorethamine) is the prototypic agent of this class, decomposing rapidly in aqueous solution to potentially yield a bifunctional carbonium ion. It must be administered shortly after preparation into a rapidly flowing intravenous line. It is a powerful vesicant, and infiltration may be symptomatically ameliorated by infiltration of the affected site with 1/6 *M* thiosulfate. Even without infiltration, aseptic thrombophlebitis is frequent. It can be used topically as a dilute solution in cutaneous lymphomas, with a notable incidence of

hypersensitivity reactions. It causes moderate nausea after intravenous administration.

Chlorambucil causes predictable myelosuppression, azoospermia, nausea, and pulmonary side effects. Busulfan can cause profound myelosuppression, alopecia, and pulmonary toxicity but is relatively “lymphocyte sparing.” Its routine use in treatment of CML has been curtailed in favor of imatinib (Gleevec) or dasatinib, but it is still employed in transplant preparation regimens. Melphalan shows variable oral bioavailability and undergoes extensive binding to albumin and  $\alpha_1$ -acidic glycoprotein. Mucositis appears more prominently; however, it has prominent activity in multiple myeloma.

Nitrosoureas break down to carbamylating species that not only cause a distinct pattern of DNA base pair-directed toxicity but also can covalently modify proteins. They share the feature of causing relatively delayed bone marrow toxicity, which can be cumulative and long-lasting. Streptozotocin is unique in that its glucose-like structure conveys specific toxicity to the islet cells of the pancreas (for whose derivative tumor types it is prominently indicated) as well as causing renal toxicity in the form of Fanconi’s syndrome, including amino aciduria, glycosuria, and renal tubular acidosis. Methyl CCNU (lomustine) causes direct glomerular as well as tubular damage, cumulatively related to dose and time of exposure.

Procarbazine is metabolized in the liver and possibly in tumor cells to yield a variety of free radical and alkylating species. In addition to myelosuppression, it causes hypnotic and other CNS effects, including vivid nightmares. It can cause a disulfiram-like syndrome on ingestion of ethanol. Altretamine (formerly hexamethylmelamine) and thiotepa can chemically give rise to alkylating species, although the nature of the DNA damage has not been well characterized in either case. Thiotepa can be used for intrathecal treatment of neoplastic meningitis. Dacarbazine (DTIC) is activated in the liver to yield the highly reactive methyl diazonium cation. It causes only modest myelosuppression 21–25 days after a dose but causes prominent nausea on day 1. Temozolomide is structurally related to dacarbazine but was designed to be activated by nonenzymatic hydrolysis in tumors and is bioavailable orally.

Cisplatin was discovered fortuitously by observing that bacteria present in electrolysis solutions could not divide. Only the *cis* diamine configuration is active as an antitumor agent. It is hypothesized that in the intracellular environment, a chloride is lost from each position, being replaced by a water molecule. The resulting positively charged species is an efficient bifunctional interactor with DNA, forming Pt-based cross-links. Cisplatin requires administration with adequate hydration, including forced diuresis with mannitol to prevent kidney damage; even with the use of hydration, gradual decrease in kidney function is common, along with noteworthy anemia. Hypomagnesemia frequently attends cisplatin use and can



360 lead to hypocalcemia and tetany. Other common toxicities include neurotoxicity with stocking-and-glove sensorimotor neuropathy. Hearing loss occurs in 50% of patients treated with conventional doses. Cisplatin is intensely emetogenic, requiring prophylactic antiemetics. Myelosuppression is less evident than with other alkylating agents. Chronic vascular toxicity (Raynaud's phenomenon, coronary artery disease) is a more unusual toxicity. Carboplatin displays less nephro-, oto-, and neurotoxicity. However, myelosuppression is more frequent, and because the drug is exclusively cleared through the kidney, adjustment of dose for creatinine clearance must be accomplished through use of various dosing nomograms. Oxaliplatin is a platinum analog with noteworthy activity in colon cancers refractory to other treatments. It is prominently neurotoxic.

### Antitumor Antibiotics and Topoisomerase Poisons

Antitumor antibiotics are substances produced by bacteria that in nature appear to provide a chemical defense against other hostile microorganisms. As a class they bind to DNA directly and can frequently undergo electron transfer reactions to generate free radicals in close proximity to DNA, leading to DNA damage in the form of single-strand breaks or cross-links. Topoisomerase poisons include natural products or semisynthetic species derived ultimately from plants, and they modify enzymes that regulate the capacity of DNA to unwind to allow normal replication or transcription. These include topoisomerase I, which creates single-strand breaks that then rejoin following the passage of the other DNA strand through the break. Topoisomerase II creates double-strand breaks through which another segment of DNA duplex passes before rejoining. DNA damage from these agents can occur in any cell cycle phase, but cells tend to arrest in S-phase or G<sub>2</sub> of the cell cycle in cells with p53 and Rb pathway lesions as the result of defective checkpoint mechanisms in cancer cells. Owing to the role of topoisomerase I in the procession of the replication fork, topoisomerase I poisons cause lethality if the topoisomerase I-induced lesions are made in S-phase.

Doxorubicin can intercalate into DNA, thereby altering DNA structure, replication, and topoisomerase II function. It can also undergo reduction reactions by accepting electrons into its quinone ring system, with the capacity to undergo reoxidation to form reactive oxygen radicals after reoxidation. It causes predictable myelosuppression, alopecia, nausea, and mucositis. In addition, it causes acute cardiotoxicity in the form of atrial and ventricular dysrhythmias, but these are rarely of clinical significance. In contrast, cumulative doses >550 mg/m<sup>2</sup> are associated with a 10% incidence of chronic cardiomyopathy. The incidence of cardiomyopathy appears to be related to schedule (peak serum concentration), with low dose, frequent treatment, or continuous infusions better tolerated than intermittent higher dose exposures. Cardiotoxicity has been related to iron-catalyzed oxidation and reduction of doxorubicin, and not to topoisomerase

action. Cardiotoxicity is related to peak plasma dose; thus lower doses and continuous infusions are less likely to cause heart damage. Doxorubicin's cardiotoxicity is increased when given together with trastuzumab (Herceptin), the anti-HER-2/neu antibody. Radiation recall or interaction with concomitantly administered radiation to cause local site complications is frequent. The drug is a powerful vesicant, with necrosis of tissue apparent 4–7 days after an extravasation; therefore it should be administered into a rapidly flowing intravenous line. Dexrazoxane is an antidote to doxorubicin-induced extravasation. Doxorubicin is metabolized by the liver, so doses must be reduced by 50–75% in the presence of liver dysfunction. Daunorubicin is closely related to doxorubicin and was actually introduced first into leukemia treatment, where it remains part of curative regimens and has been shown preferable to doxorubicin owing to less mucositis and colonic damage. Idarubicin is also used in acute myeloid leukemia treatment and may be preferable to daunorubicin in activity. Encapsulation of daunorubicin into a liposomal formulation has attenuated cardiac toxicity and antitumor activity in Kaposi's sarcoma and ovarian cancer.

Bleomycin refers to a mixture of glycopeptides that have the unique feature of forming complexes with Fe<sup>2+</sup> while also bound to DNA. Oxidation of Fe<sup>2+</sup> gives rise to superoxide and hydroxyl radicals. The drug causes little, if any, myelosuppression. The drug is cleared rapidly, but augmented skin and pulmonary toxicity in the presence of renal failure has led to the recommendation that doses be reduced by 50–75% in the face of a creatinine clearance <25 mL/min. Bleomycin is not a vesicant and can be administered intravenously, intramuscularly, or subcutaneously. Common side effects include fever and chills, facial flush, and Raynaud's phenomenon. Hypertension can follow rapid intravenous administration, and the incidence of anaphylaxis with early preparations of the drug has led to the practice of administering a test dose of 0.5–1 unit before the rest of the dose. The most feared complication of bleomycin treatment is pulmonary fibrosis, which increases in incidence at >300 cumulative units administered and is minimally responsive to treatment (e.g., glucocorticoids). The earliest indicator of an adverse effect is a decline in the DLCO, although cessation of drug immediately upon documentation of a decrease in DLCO may not prevent further decline in pulmonary function. Bleomycin is inactivated by a bleomycin hydrolase, whose concentration is diminished in skin and lung. Because bleomycin-dependent electron transport is dependent on O<sub>2</sub>, bleomycin toxicity may become apparent after exposure to transient very high P<sub>IO<sub>2</sub></sub>. Thus, during surgical procedures, patients with prior exposure to bleomycin should be maintained on the lowest P<sub>IO<sub>2</sub></sub> consistent with maintaining adequate tissue oxygenation.

Mitomycin C undergoes reduction of its quinone function to generate a bifunctional DNA alkylating agent. It is a broadly active antineoplastic agent with a number of unpredictable toxicities, including delayed bronchospasm

12–14 h after dosing and a chronic pulmonary fibrosis syndrome more frequent at doses of 50–60 mg/m<sup>2</sup>. Cardiomyopathy has been described, particularly in a setting of prior radiation therapy. A hemolytic/uremic syndrome carries an ultimate mortality rate of 25–50% and is poorly treated by conventional component support and exchange transfusion. Mitomycin is a notable vesicant and causes substantial nausea and vomiting. It can be used for intravesical instillation for curative treatment of superficial transitional bladder carcinomas and, with radiation therapy, for curative treatment of anal carcinoma.

Mitoxantrone is a synthetic compound that was designed to recapitulate features of doxorubicin but with less cardiotoxicity. It is quantitatively less cardiotoxic (comparing the ratio of cardiotoxic to therapeutically effective doses) but is still associated with a 10% incidence of cardiotoxicity at cumulative doses of >150 mg/m<sup>2</sup>. It also causes alopecia. Cases of acute promyelocytic leukemia (APL) have arisen shortly after exposure of patients to mitoxantrone, particularly in the adjuvant treatment of breast cancer. Whereas chemotherapy-associated leukemia is generally of the acute myeloid type, APL arising in the setting of prior mitoxantrone treatment had the typical t(15;17) chromosome translocation associated with APL, but the breakpoints of the translocation appeared to be at topoisomerase II sites that would be preferred sites of mitoxantrone action, clearly linking the action of the drug to the generation of the leukemia.

Etoposide was synthetically derived from the plant product podophyllotoxin; it binds directly to topoisomerase II and DNA in a reversible ternary complex. It stabilizes the covalent intermediate in the enzyme's action where the enzyme is covalently linked to DNA. This "alkali-labile" DNA bond was historically a first hint that an enzyme such as a topoisomerase might exist. The drug therefore causes a prominent G<sub>2</sub> arrest, reflecting the action of a DNA damage checkpoint. Prominent clinical effects include myelosuppression, nausea, and transient hypotension related to the speed of administration of the agent. Etoposide is a mild vesicant but relatively free from other large-organ toxicities. When given at high doses or very frequently, topoisomerase II inhibitors may cause acute leukemia associated with chromosome 11q23 abnormalities in up to 1% of exposed patients.

Camptothecin was isolated from extracts of a Chinese tree and had notable antileukemia activity. Early clinical studies with the sodium salt of the hydrolyzed camptothecin lactone showed evidence of toxicity with little antitumor activity. Identification of topoisomerase I as the target of camptothecins and the need to preserve lactone structure allowed additional efforts to identify active members of this series. Topoisomerase I is responsible for unwinding the DNA strand by introducing single-strand breaks and allowing rotation of one strand about the other. In S-phase, topoisomerase I-induced breaks that are not promptly resealed lead to progress of the replication fork off the end of a DNA strand. The

DNA damage is a potent signal for induction of apoptosis. Camptothecins promote the stabilization of the DNA linked to the enzyme in a so-called cleavable complex, analogous to the action of etoposide with topoisomerase II. Topotecan is a camptothecin derivative approved for use in gynecologic tumors and small cell lung cancer. Toxicity is limited to myelosuppression and mucositis. CPT-11, or irinotecan, is a camptothecin with evidence of activity in colon carcinoma. In addition to myelosuppression, it causes a secretory diarrhea related to the toxicity of a metabolite called SN-38. The diarrhea can be treated effectively with loperamide or octreotide.

### **Indirect Effectors of DNA Function: Antimetabolites**

A broad definition of antimetabolites would include compounds with structural similarity to precursors of purines or pyrimidines, or compounds that interfere with purine or pyrimidine synthesis. Antimetabolites can cause DNA damage indirectly, through misincorporation into DNA, abnormal timing or progression through DNA synthesis, or altered function of pyrimidine and purine biosynthetic enzymes. They tend to convey greatest toxicity to cells in S-phase, and the degree of toxicity increases with duration of exposure. Common toxic manifestations include stomatitis, diarrhea, and myelosuppression. Second malignancies are not associated with their use.

Methotrexate inhibits dihydrofolate reductase, which regenerates reduced folates from the oxidized folates produced when thymidine monophosphate is formed from deoxyuridine monophosphate. Without reduced folates, cells die a "thymine-less" death. N<sup>5</sup>-tetrahydrofolate or N<sup>5</sup>-formyltetrahydrofolate (leucovorin) can bypass this block and rescue cells from methotrexate, which is maintained in cells by polyglutamylation. The drug and other reduced folates are transported into cells by the folate carrier, and high concentrations of drug can bypass this carrier and allow diffusion of drug directly into cells. These properties have suggested the design of "high-dose" methotrexate regimens with leucovorin rescue of normal marrow and mucosa as part of curative approaches to osteosarcoma in the adjuvant setting and hematopoietic neoplasms of children and adults. Methotrexate is cleared by the kidney via both glomerular filtration and tubular secretion, and toxicity is augmented by renal dysfunction and drugs such as salicylates, probenecid, and nonsteroidal anti-inflammatory agents that undergo tubular secretion. With normal renal function, 15 mg/m<sup>2</sup> leucovorin will rescue 10<sup>-8</sup> to 10<sup>-6</sup> M methotrexate in three to four doses. However, with decreased creatinine clearance, doses of 50–100 mg/m<sup>2</sup> are continued until methotrexate levels are <5 × 10<sup>-8</sup> M. In addition to bone marrow suppression and mucosal irritation, methotrexate can cause renal failure itself at high doses owing to crystallization in renal tubules; therefore, high-dose regimens require alkalinization of urine with increased flow by hydration.

362 Methotrexate can be sequestered in third-space collections and leach back into the general circulation, causing prolonged myelosuppression. Less frequent adverse effects include reversible increases in transaminases and hypersensitivity-like pulmonary syndrome. Chronic low-dose methotrexate can cause hepatic fibrosis. When administered to the intrathecal space, methotrexate can cause chemical arachnoiditis and CNS dysfunction.

Pemetrexed is a novel folate-directed antimetabolite. It is “multitargeted” in that it inhibits the activity of several enzymes, including thymidylate synthetase, dihydrofolate reductase, and glycinamide ribonucleotide formyltransferase, thereby affecting the synthesis of both purine and pyrimidine nucleic acid precursors. To avoid significant toxicity to the normal tissues, patients receiving pemetrexed should also receive low-dose folate and vitamin B<sub>12</sub> supplementation. Pemetrexed has notable activity against certain lung cancers and, in combination with cisplatin, also against mesotheliomas.

5-Fluorouracil (5FU) represents an early example of “rational” drug design in that it originated from the observation that tumor cells incorporate radiolabeled uracil more efficiently into DNA than normal cells, especially gut. 5FU is metabolized in cells to 5’FdUMP, which inhibits thymidylate synthetase (TS). In addition, misincorporation can lead to single-strand breaks, and RNA can aberrantly incorporate FUMP. 5FU is metabolized by dihydropyrimidine dehydrogenase, and deficiency of this enzyme can lead to excessive toxicity from 5FU. Oral bioavailability varies unreliably, but orally administered analogues of 5FU such as capecitabine have been developed that allow at least equivalent activity to many parenteral 5FU-based approaches to refractory cancers. Intravenous administration of 5FU leads to bone marrow suppression after short infusions but to stomatitis after prolonged infusions. Leucovorin augments the activity of 5FU by promoting formation of the ternary covalent complex of 5FU, the reduced folate, and TS. Less frequent toxicities include CNS dysfunction, with prominent cerebellar signs, and endothelial toxicity manifested by thrombosis, including pulmonary embolus and myocardial infarction.

Cytosine arabinoside (ara-C) is incorporated into DNA after formation of ara-CTP, resulting in S-phase-related toxicity. Continuous infusion schedules allow maximal efficiency, with uptake maximal at 5–7  $\mu$ M. Ara-C can be administered intrathecally. Adverse effects include nausea, diarrhea, stomatitis, chemical conjunctivitis, and cerebellar ataxia. Gemcitabine is a cytosine derivative that is similar to ara-C in that it is incorporated into DNA after anabolism to the triphosphate, rendering DNA susceptible to breakage and repair synthesis, which differs from that in ara-C in that gemcitabine-induced lesions are very inefficiently removed. In contrast to ara-C, gemcitabine appears to have useful activity in a variety of solid tumors, with limited nonmyelosuppressive toxicities. 6-Thioguanine and

6-mercaptopurine (6MP) are used in the treatment of acute lymphoid leukemia. Although administered orally, they display variable bioavailability. 6MP is metabolized by xanthine oxidase and therefore requires dose reduction when used with allopurinol.

Fludarabine phosphate is a prodrug of F-adenine arabinoside (F-ara-A), which in turn was designed to diminish the susceptibility of ara-A to adenosine deaminase. F-ara-A is incorporated into DNA and can cause delayed cytotoxicity even in cells with low growth fraction, including chronic lymphocytic leukemia and follicular B cell lymphoma. CNS and peripheral nerve dysfunction and T cell depletion leading to opportunistic infections can occur in addition to myelosuppression. 2-Chlorodeoxyadenosine is a similar compound with activity in hairy cell leukemia. 2-Deoxycoformycin inhibits adenosine deaminase, with resulting increase in dATP levels. This causes inhibition of ribonucleotide reductase as well as augmented susceptibility to apoptosis, particularly in T cells. Renal failure and CNS dysfunction are notable toxicities in addition to immunosuppression. Hydroxyurea inhibits ribonucleotide reductase, resulting in S-phase block. It is orally bioavailable and useful for the acute management of myeloproliferative states.

Asparaginase is a bacterial enzyme that causes breakdown of extracellular asparagine required for protein synthesis in certain leukemic cells. This effectively stops tumor cell DNA synthesis because DNA synthesis requires concurrent protein synthesis. The outcome of asparaginase action is therefore very similar to the result of the small-molecule antimetabolites. Because asparaginase is a foreign protein, hypersensitivity reactions are common, as are effects on organs such as pancreas and liver that normally require continuing protein synthesis. This may result in decreased insulin secretion with hyperglycemia, with or without hyperamylasemia and clotting function abnormalities. Close monitoring of clotting functions should accompany use of asparaginase. Paradoxically, owing to depletion of rapidly turning over anticoagulant factors, thromboses particularly affecting the CNS may also be seen with asparaginase.

### **Mitotic Spindle Inhibitors**

Microtubules are cellular structures that form the mitotic spindle, and in interphase cells they are responsible for the cellular “scaffolding” along which various motile and secretory processes occur. Microtubules are composed of repeating noncovalent multimers of a heterodimer of  $\alpha$  and subunits of the protein tubulin. Vincristine binds to the tubulin dimer with the result that microtubules are disaggregated. This results in the block of growing cells in M-phase; however, toxic effects in G<sub>1</sub> and S-phase are also evident. Vincristine is metabolized by the liver, and dose adjustment in the presence of hepatic dysfunction is required. It is a powerful vesicant, and infiltration can be

treated by local heat and infiltration of hyaluronidase. At clinically used intravenous doses, neurotoxicity in the form of glove-and-stocking neuropathy is frequent. Acute neuropathic effects include jaw pain, paralytic ileus, urinary retention, and the syndrome of inappropriate antidiuretic hormone secretion. Myelosuppression is not seen. Vinblastine is similar to vincristine, except that it tends to be more myelotoxic, with more frequent thrombocytopenia and also mucositis and stomatitis. Vinorelbine is a vinca alkaloid that appears to have differences in resistance patterns in comparison to vincristine and vinblastine; it may be administered orally.

The taxanes include paclitaxel and docetaxel. These agents differ from the vinca alkaloids in that the taxanes stabilize microtubules against depolymerization. The “stabilized” microtubules function abnormally and are not able to undergo the normal dynamic changes of microtubule structure and function necessary for cell cycle completion. Taxanes are among the most broadly active antineoplastic agents for use in solid tumors, with evidence of activity in ovarian cancer, breast cancer, Kaposi’s sarcoma, and lung tumors. They are administered intravenously, and paclitaxel requires use of a Cremophor-containing vehicle that can cause hypersensitivity reactions. Premedication with dexamethasone (20 mg orally or intravenously 12 and 6 h before treatment) and diphenhydramine (50 mg) and cimetidine (300 mg), both 30 min before treatment, decreases but does not eliminate the risk of hypersensitivity reactions to the paclitaxel vehicle. Docetaxel uses a polysorbate 80 formulation, which can cause fluid retention in addition to hypersensitivity reactions, and dexamethasone premedication with or without antihistamines is frequently used. A protein-bound formulation of paclitaxel (called *nab-paclitaxel*) has at least equivalent antineoplastic activity and decreased risk of hypersensitivity reactions. Paclitaxel may also cause hypersensitivity reactions, myelosuppression, neurotoxicity in the form of glove-and-stocking numbness, and paresthesia. Cardiac rhythm disturbances were observed in phase I and II trials, most commonly asymptomatic bradycardia but also, much more rarely, varying degrees of heart block. These have not emerged as clinically significant in most patients. Docetaxel causes comparable degrees of myelosuppression and neuropathy. Hypersensitivity reactions, including bronchospasm, dyspnea, and hypotension, are less frequent but occur to some degree in up to 25% of patients. Fluid retention appears to result from a vascular leak syndrome that can aggravate preexisting effusions. Rash can complicate docetaxel administration, appearing prominently as a pruritic maculopapular rash affecting the forearms, but it has also been associated with fingernail ridging, breakdown, and skin discoloration. Stomatitis appears to be somewhat more frequent than with paclitaxel.

Estramustine was originally synthesized as a mustard derivative that might be useful in neoplasms that possessed

estrogen receptors. However, no evidence of interaction with DNA was observed. Surprisingly, the drug caused metaphase arrest, and subsequent study revealed that it binds to microtubule-associated proteins, resulting in abnormal microtubule function. Estramustine binds to estramustine-binding proteins (EMBPs), which are notably present in prostate tumor tissue. The drug is used as an oral formulation in patients with prostate cancer. Gastrointestinal and cardiovascular adverse effects related to the estrogen moiety occur in up to 10% of patients, including worsened heart failure and thromboembolic phenomena. Gynecomastia and nipple tenderness can also occur.

### Hormonal Agents

The family of steroid hormone receptor-related molecules has emerged as prominent targets for small molecules useful in cancer treatment. When bound to their cognate ligands, these receptors can alter gene transcription and, in certain tissues, induce apoptosis. The pharmacologic effect is a mirror or parody of the normal effects of the agent acting in nontransformed tissue, although the effects on tumors are mediated by indirect effects in some cases.

Glucocorticoids are generally given in “pulsed” high doses in leukemias and lymphomas, where they induce apoptosis in tumor cells. Cushing’s syndrome or inadvertent adrenal suppression on withdrawal from high-dose glucocorticoids can be significant complications, along with infections common in immunosuppressed patients, in particular *Pneumocystis* pneumonia, which classically appears a few days after completing a course of high-dose glucocorticoids.

Tamoxifen is a partial estrogen receptor antagonist; it has a tenfold greater antitumor activity in breast cancer patients whose tumors express estrogen receptors than in those who have low or no levels of expression. Side effects include a somewhat increased risk of estrogen-related cardiovascular complications, such as thromboembolic phenomena, and a small increased incidence of endometrial carcinoma, which appears after chronic use (usually >5 years). Progestational agents—including medroxyprogesterone acetate, androgens including fluoxymesterone (Halotestin), and, paradoxically, estrogens—have approximately the same degree of activity in primary hormonal treatment of breast cancers that have elevated expression of estrogen receptor protein. Estrogen is not used often owing to prominent cardiovascular and uterotrophic activity.

*Aromatase* refers to a family of enzymes that catalyze the formation of estrogen in various tissues, including the ovary and peripheral adipose tissue and some tumor cells. Aromatase inhibitors are of two types, the irreversible steroid analogs such as exemestane and the reversible inhibitors such as anastrozole or letrozole. Anastrozole is superior to tamoxifen in the adjuvant

364 treatment of breast cancer in postmenopausal patients with estrogen receptor–positive tumors. Letrozole treatment affords benefit following tamoxifen treatment. Adverse effects of aromatase inhibitors may include an increased risk of osteoporosis.

Prostate cancer is classically treated by androgen deprivation. Diethylstilbestrol (DES) acting as an estrogen at the level of the hypothalamus to downregulate hypothalamic luteinizing hormone (LH) production results in decreased elaboration of testosterone by the testicle. For this reason, orchiectomy is equally as effective as moderate-dose DES, inducing responses in 80% of previously untreated patients with prostate cancer but without the prominent cardiovascular side effects of DES, including thrombosis and exacerbation of coronary artery disease. In the event that orchiectomy is not accepted by the patient, testicular androgen suppression can also be effected by luteinizing hormone–releasing hormone (LHRH) agonists such as leuprolide and goserelin. These agents cause tonic stimulation of the LHRH receptor, with the loss of its normal pulsatile activation resulting in decreased output of LH by the anterior pituitary. Therefore, as primary hormonal manipulation in prostate cancer, one can choose orchiectomy or leuprolide, but not both. The addition of androgen receptor blockers, including flutamide or bicalutamide, is of uncertain additional benefit in extending overall response duration; the combined use of orchiectomy or leuprolide plus flutamide is referred to as *total androgen blockade*.

Tumors that respond to a primary hormonal manipulation may frequently respond to second and third hormonal manipulations. Thus breast tumors that had previously responded to tamoxifen have, on relapse, notable response rates to withdrawal of tamoxifen itself or to subsequent addition of an aromatase inhibitor or progestin. Likewise, initial treatment of prostate cancers with leuprolide plus flutamide may be followed after disease progression by response to withdrawal of flutamide. These responses may result from the removal of antagonists from mutant steroid hormone receptors that have come to depend on the presence of the antagonist as a growth-promoting influence.

Additional strategies to treat refractory breast and prostate cancers that possess steroid hormone receptors may also address adrenal capacity to produce androgens and estrogens, even after orchiectomy or oophorectomy, respectively. Thus aminoglutethimide or ketoconazole can be used to block adrenal synthesis by interfering with the enzymes of steroid hormone metabolism. Administration of these agents requires concomitant hydrocortisone replacement and additional glucocorticoid doses administered in the event of physiologic stress.

Humoral mechanisms can also result in complications of an underlying malignancy. Adrenocortical carcinomas can cause Cushing's syndrome as well as syndromes of androgen or estrogen excess. Mitotane can counteract

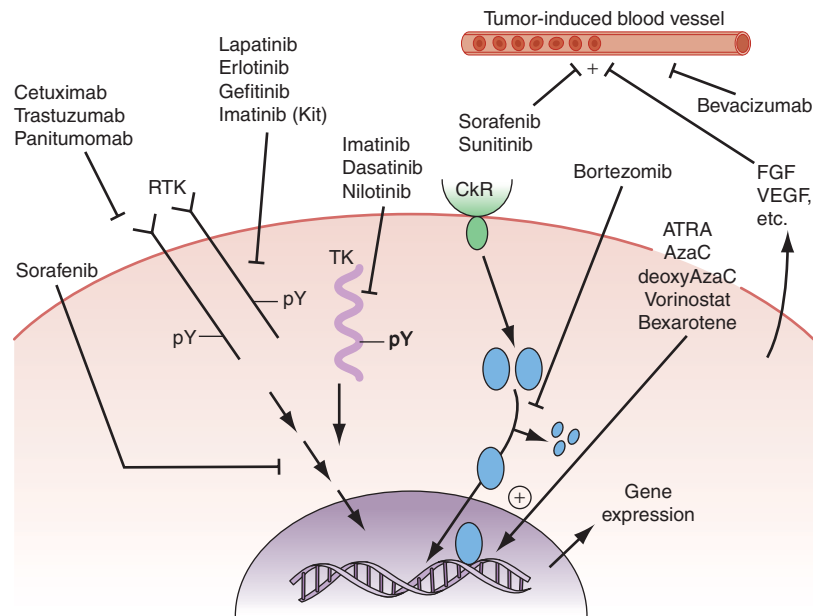
these by decreasing synthesis of steroid hormones. Islet cell neoplasms can cause debilitating diarrhea, treated with the somatostatin analogue octreotide. Prolactin-secreting tumors can be effectively managed by the dopaminergic agonist bromocriptine.

## TARGETED THERAPIES

A better understanding of cancer cell biology has suggested many new targets for cancer drug discovery and development. These include the products of oncogenes and tumor-suppressor genes, regulators of cell death pathways, mediators of cellular immortality such as telomerase, and molecules responsible for microenvironmental molding such as proteases or angiogenic factors. The essential difference in the development of agents that would target these processes is that the basis for discovery of the candidate drug is the a priori importance of the target in the biology of the tumor, rather than the initial detection of drug candidates based on the phenomenon of tumor cell regression in tissue culture or in animals. The following examples reflect the rapidly evolving clinical research activity in this area. **Figure 27-4** summarizes how FDA-approved targeted agents act.

### *Hematopoietic Neoplasms*

Imatinib targets the ATP binding site of the p210<sup>bcr-abl</sup> protein tyrosine kinase that is formed as the result of the chromosome 9,22 translocation producing the Philadelphia chromosome in CML. Imatinib is superior to interferon plus chemotherapy in the initial treatment of the chronic phase of this disorder. It has lesser activity in the blast phase of CML, where the cells may have acquired additional mutations in p210<sup>bcr-abl</sup> itself or other genetic lesions. Its side effects are relatively tolerable in most patients and include hepatic dysfunction, diarrhea, and fluid retention. Rarely, patients receiving imatinib have decreased cardiac function, which may persist after discontinuation of the drug. The quality of response to imatinib enters into the decision about when to refer patients with CML for consideration of transplant approaches. Nilotinib is a tyrosine protein kinase inhibitor with a similar spectrum of activity to imatinib, but with increased potency and perhaps better tolerance by certain patients. Dasatinib, another inhibitor of the p210<sup>bcr-abl</sup> oncoproteins, is active in certain mutant variants of p210<sup>bcr-abl</sup> that are refractory to imatinib and arise during therapy with imatinib or are present de novo. Dasatinib also has inhibitory action against kinases belonging to the src tyrosine protein kinase family; this activity may contribute to its effects in hematopoietic tumors and suggest a role in solid tumors where src kinases are active. Only the T315I mutant is resistant to dasatinib; a new class of inhibitors called aurora kinase inhibitors is in development to address this problem.



**FIGURE 27-4**

**Site of action of targeted agents.** Signals proceeding from growth factor–related receptor tyrosine kinases (RTKs) such as EGF-R, erbB2, or c-kit can be interrupted by lapatinib, erlotinib, gefitinib, and imatinib, acting at the ATP binding site; or by cetuximab, trastuzumab, or panitumomab. Tyrosine kinases (TKs) that are not directly stimulated by growth factors such as p210 bcr-abl or src can be inhibited by imatinib, dasatinib, or nilotinib. Signals projected downstream from growth factor receptors can be affected by the multitargeted kinase inhibitor sorafenib, acting on c-raf, and, upon arrival at the nucleus, affect gene expression, which can be affected by the targeted transcriptional modulators Vorinostat (targeting histone

deacetylase), azacytidine derivatives (targeting DNA methyltransferase), or retinoid receptor modulators all-*trans*-retinoic acid (ATRA) or bexarotene. Cytokine receptors (CkRs) are one stimulus for degradation of the inhibitory subunit of the NFκB transcription factor by the proteasome. Bortezomib inhibits this process and can prevent activation of NFκB-dependent genes, among other growth-related effects. Sorafenib and sunitinib, acting as inhibitors of VEGF receptors, can modulate tumor blood vessel function through their action on endothelial cells; bevacizumab targets the same process by combining with VEGF itself.

All-*trans*-retinoic acid (ATRA) targets the PML-retinoic acid receptor (RAR) α fusion protein, which is the result of the chromosome 15,17 translocation pathogenic for most forms of APL. Administered orally, it causes differentiation of the neoplastic promyelocytes to mature granulocytes and attenuates the rate of hemorrhagic complications. Adverse effects include headache with or without pseudotumor cerebri and gastrointestinal and cutaneous toxicities. Another active retinoid is the synthetic retinoid X receptor ligand bexarotene, which has activity in cutaneous T cell lymphoma.

Bortezomib is an inhibitor of the proteasome, the multi-subunit assembly of protease activities responsible for the selective degradation of proteins important in regulating activation of transcription factors, including NFκB and proteins regulating cell cycle progression. It has activity in multiple myeloma and certain lymphomas. Adverse effects include neuropathy, orthostatic hypotension with or without hyponatremia, and reversible thrombocytopenia.

Vorinostat is an inhibitor of histone deacetylases, responsible for maintaining the proper orientation of histones on DNA, with resulting capacity for transcriptional

readiness. Acetylated histones allow entry of transcription factors and therefore increased expression of genes that are selectively repressed in tumors. The result can be differentiation with the emergence of a more normal cellular phenotype, or cell cycle arrest with expression of endogenous regulators of cell cycle progression. Vorinostat is approved for clinical use in cutaneous T cell lymphoma, with dramatic skin clearing and very few side effects.

DNA methyltransferase inhibitors including 5-azacytidine and 2'-deoxy-5-azacytidine can also increase transcription of genes “silenced” during the pathogenesis of a tumor by causing demethylation of the methylated cytosines that are acquired as an “epigenetic” (i.e., after the DNA is replicated) modification of DNA. These drugs were originally considered antimetabolites but have clinical value in myelodysplastic syndromes and certain leukemias when administered at low doses. Combinations of DNA methyltransferase inhibitors and histone deacetylase inhibitors may offer new approaches to reregulate chromatin function.

Targeted toxins use macromolecules such as antibodies or cytokines with high affinity for defined tumor cell

366 surface molecules, such as a leukemia differentiation antigen, to which a therapeutic antibody can deliver a covalently linked potent cytotoxin (e.g., gemtuzumab ozogamicin, a drug linked to anti-CD33), or a growth factor such as IL-2 to deliver a toxin (in the form of diphtheria toxin in denileukin diftitox) to cells bearing the IL-2 receptor. The value of such targeted approaches is that in addition to maximizing the therapeutic index by differential expression of the target in tumor (as opposed to nonrenewable normal cells), selection of patients for clinical use can capitalize on assessing the target in the tumor.

### Solid Tumors

Small-molecule epidermal growth factor (EGF) antagonists act at the ATP binding site of the EGF receptor tyrosine kinase. In early clinical trials, gefitinib showed evidence of responses in a small fraction of patients with non-small cell lung cancer. Side effects were generally acceptable, consisting mostly of rash and diarrhea. Gefitinib was found to have antitumor activity mainly in the subset of patients with tumors containing activating mutations in the EGF receptor. Often patients who developed resistance to gefitinib have acquired additional mutations in the enzyme, similar to what was seen in imatinib-resistant CML. Erlotinib is another EGF receptor tyrosine kinase antagonist with somewhat superior activity to gefitinib in clinical trials in non-small cell lung cancer. Even patients with wild-type EGF receptors may benefit from erlotinib treatment. Lapatinib is a combined EGF receptor and erbB2 tyrosine kinase antagonist with activity in breast cancers refractory to anti-erbB2 antibodies.

In addition to the p210<sup>bcr-abl</sup> kinase, imatinib also has activity against the c-kit tyrosine kinase, activated in gastrointestinal stromal sarcoma, and the platelet-derived growth factor receptor (PDGF-R), activated by translocation in certain sarcomas. Imatinib has found clinical utility in these neoplasms previously refractory to chemotherapeutic approaches.

“Multitargeted” kinase antagonists are small-molecule ATP site-directed antagonists that inhibit more than one protein kinase. Drugs of this type with prominent activity against the vascular endothelial growth factor receptor (VEGF-R) tyrosine kinase have activity in renal cell carcinoma. Sorafenib is a VEGF-R antagonist with activity against the *raf* serine-threonine protein kinase as well. Sunitinib has anti-VEGF-R as well as anti-PDGF-R and anti-c-kit activity. It causes prominent responses as well as stabilization of disease in renal cell cancers and gastrointestinal stromal tumors. Side effects for both agents are mostly acceptable, with fatigue and diarrhea encountered with both agents. The “hand-foot syndrome” with erythema and desquamation of the distal extremities, in some cases requiring dose modification,

may be seen with sorafenib. Temsirolimus, an mTOR inhibitor, has activity in renal and breast cancer. It produces some hyperlipidemia (10%), myelosuppression (10%), and rare lung toxicity.

## ACUTE COMPLICATIONS OF CANCER CHEMOTHERAPY

### Myelosuppression

The common cytotoxic chemotherapeutic agents almost invariably affect bone marrow function. Titration of this effect determines the MTD of the agent on a given schedule. The normal kinetics of blood cell turnover influence the sequence and sensitivity of each of the formed elements. Polymorphonuclear leukocytes (PMNs;  $t_{1/2} = 6-8$  h), platelets ( $t_{1/2} = 5-7$  days), and red blood cells (RBCs;  $t_{1/2} = 120$  days) respectively have most, less, and least susceptibility to usually administered cytotoxic agents. The nadir count of each cell type in response to classes of agents is characteristic. Maximal neutropenia occurs 6–14 days after conventional doses of anthracyclines, antifolates, and antimetabolites. Alkylating agents differ from each other in the timing of cytopenias. Nitrosoureas, DTIC, and procarbazine can display delayed marrow toxicity, first appearing 6 weeks after dosing.

Complications of myelosuppression result from the predictable sequelae of the missing cells' function. *Febrile neutropenia* refers to the clinical presentation of fever (one temperature  $\geq 38.5^\circ\text{C}$  or three readings  $\geq 38^\circ\text{C}$  but  $\leq 38.5^\circ\text{C}$  per 24 h) in a neutropenic patient with an uncontrolled neoplasm involving the bone marrow or, more usually, in a patient undergoing treatment with cytotoxic agents. Mortality from uncontrolled infection varies inversely with the neutrophil count. If the nadir neutrophil count is  $>1000/\mu\text{L}$ , there is little risk; if  $<500/\mu\text{L}$ , risk of death is markedly increased. Management of febrile neutropenia has conventionally included empirical coverage with antibiotics for the duration of neutropenia (Chap. 28). Selection of antibiotics is governed by the expected association of infections with certain underlying neoplasms; careful physical examination (with scrutiny of catheter sites, dentition, mucosal surfaces, and perirectal and genital orifices by gentle palpation); chest x-ray; and Gram stain and culture of blood, urine, and sputum (if any) to define a putative site of infection. In the absence of any originating site, a broadly acting  $\beta$ -lactam with anti-*Pseudomonas* activity, such as ceftazidime, is begun empirically. The addition of vancomycin to cover potential cutaneous sites of origin (until these are ruled out or shown to originate from methicillin-sensitive organisms) or metronidazole or imipenem for abdominal or other sites favoring anaerobes reflects modifications tailored to individual patient presentations. The coexistence of pulmonary compromise raises a distinct set of potential pathogens, including *Legionella*,

*Pneumocystis*, and fungal agents that may require further diagnostic evaluations such as bronchoscopy with bronchoalveolar lavage. Febrile neutropenic patients can be stratified broadly into two prognostic groups. The first, with expected short duration of neutropenia and no evidence of hypotension or abdominal or other localizing symptoms, may be expected to do well even with oral regimens, e.g., ciprofloxacin or moxifloxacin, or amoxicillin plus clavulanic acid. A less favorable prognostic group are patients with expected prolonged neutropenia, evidence of sepsis, and end-organ compromise, particularly pneumonia. These patients clearly require tailoring of their antibiotic regimen to their underlying presentation, with frequent empirical addition of antifungal agents if fever persists for 7 days without identification of an adequately treated organism or site.

Transfusion of granulocytes has no role in the management of febrile neutropenia, owing to their exceedingly short half-life, mechanical fragility, and clinical syndromes of pulmonary compromise with leukostasis after their use. Instead, colony-stimulating factors (CSFs) are used to augment bone marrow production of PMNs. Early-acting factors such as IL-1, IL-3, and stem cell factor have not been as useful clinically as late-acting, lineage-specific factors such as G-CSF (granulocyte colony-stimulating factor) or GM-CSF (granulocyte-macrophage colony-stimulating factor), erythropoietin (EPO), thrombopoietin, IL-6, and IL-11. CSFs may easily become overused in oncology practice. The settings in which their use has been proved effective are limited. G-CSF, GM-CSF, EPO, and IL-11 are currently approved for use. The American Society of Clinical Oncology has developed practice guidelines for the use of G-CSF and GM-CSF (Table 27-3).

Primary prophylaxis (i.e., shortly after completing chemotherapy to reduce the nadir) of G-CSF to patients receiving cytotoxic regimens is associated with a 20% incidence of febrile neutropenia. “Dose-dense” regimens, where cycling of chemotherapy is intended to be completed without delay of administered doses, may also benefit, but such patients should be on a clinical trial. Administration of G-CSF in these circumstances has reduced the incidence of febrile neutropenia in several studies by ~50%. Most patients, however, receive regimens that do not have such a high risk of expected febrile neutropenia, and therefore most patients initially should not receive G-CSF or GM-CSF. Special circumstances—such as a documented history of febrile neutropenia with the regimen in a particular patient or categories of patient at increased risk, such as patients >65 years of age with aggressive lymphoma treated with curative chemotherapy regimens; extensive compromise of marrow by prior radiation or chemotherapy; or active, open wounds or deep-seated infection—may support primary treatment with G-CSF or GM-CSF. Administration of G-CSF or GM-CSF to afebrile

neutropenic patients or to patients with low-risk febrile neutropenia is not recommended, and patients receiving concomitant chemoradiation treatment, particularly those with thoracic neoplasms, likewise are not generally recommended for treatment. In contrast, administration of G-CSF to high-risk patients with febrile neutropenia and evidence of organ compromise including sepsis syndrome, invasive fungal infection, concurrent hospitalization at the time fever develops, pneumonia, profound neutropenia ( $<0.1 \times 10^9/L$ ), or age >65 years is reasonable.

*Secondary prophylaxis* refers to the administration of CSFs in patients who have experienced a neutropenic complication from a prior cycle of chemotherapy; dose reduction or delay may be a reasonably considered alternative. G-CSF or GM-CSF is conventionally started 24–72 h after completion of chemotherapy and continued until a PMN count of 10,000/ $\mu L$  is achieved, unless a “depot” preparation of G-CSF such as peg-filgrastim is used, where one dose is administered at least 14 days before the next scheduled administration of chemotherapy. Also, patients with myeloid leukemias undergoing induction therapy may have a slight reduction in the duration of neutropenia if G-CSF is commenced after completion of therapy and may be of particular value in elderly patients, but the influence on long-term outcome has not been defined. GM-CSF probably has a more restricted utility than G-CSF, with its use currently limited to patients after autologous bone marrow transplants, although proper head-to-head comparisons with G-CSF have not been conducted in most instances. GM-CSF may be associated with more systemic side effects.

Dangerous degrees of thrombocytopenia do not frequently complicate the management of patients with solid tumors receiving cytotoxic chemotherapy (with the possible exception of certain carboplatin-containing regimens), but they are frequent in patients with certain hematologic neoplasms where marrow is infiltrated with tumor. Severe bleeding related to thrombocytopenia occurs with increased frequency at platelet counts  $<20,000/\mu L$  and is very prevalent at counts  $<5000/\mu L$ . The precise “trigger” point at which to transfuse patients is being evaluated in a randomized study. This issue is important not only because of the costs of frequent transfusion, but unnecessary platelet transfusions expose the patient to the risks of allosensitization and loss of value from subsequent transfusion owing to rapid platelet clearance, as well as the infectious and hypersensitivity risks inherent in any transfusion. Prophylactic transfusions to keep platelets  $>20,000/\mu L$  are reasonable in patients with leukemia who are stressed by fever or concomitant medical conditions (the threshold for transfusion is 10,000/ $\mu L$  in patients with solid tumors and no other bleeding diathesis or physiologic stressors such as fever or hypotension, a level that might also be reasonably considered for leukemia patients who are



**TABLE 27-3****INDICATIONS FOR THE CLINICAL USE OF G-CSF OR GM-CSF****Preventive Uses**

With the first cycle of chemotherapy (so-called primary CSF administration)  
 Not needed on a routine basis  
 Use if the probability of febrile neutropenia is  $\geq 20\%$   
 Use if patient has preexisting neutropenia or active infection  
 Age  $>65$  years treated for lymphoma with curative intent or other tumor treated by similar regimens  
 Poor performance status  
 Extensive prior chemotherapy  
 Dose-dense regimens in a clinical trial or with strong evidence of benefit

With subsequent cycles if febrile neutropenia has previously occurred (so-called secondary CSF administration)  
 Not needed after short duration neutropenia without fever  
 Use if patient had febrile neutropenia in previous cycle  
 Use if prolonged neutropenia (even without fever) delays therapy

**Therapeutic Uses**

Afebrile neutropenic patients  
 No evidence of benefit

Febrile neutropenic patients  
 No evidence of benefit  
 May feel compelled to use in the face of clinical deterioration from sepsis, pneumonia, or fungal infection, but benefit unclear

In bone marrow or peripheral blood stem cell transplantation  
 Use to mobilize stem cells from marrow  
 Use to hasten myeloid recovery

In acute myeloid leukemia  
 G-CSF of minor or no benefit  
 GM-CSF of no benefit and may be harmful

In myelodysplastic syndromes  
 Not routinely beneficial  
 Use intermittently in subset with neutropenia and recurrent infection

**What Dose and Schedule Should Be Used?**

G-CSF: 5  $\mu\text{g}/\text{kg}$  per day subcutaneously  
 GM-CSF: 250  $\text{mg}/\text{m}^2$  per day subcutaneously  
 Peg-filgrastim: one dose of 6 mg 24 h after chemotherapy

**When Should Therapy Begin and End?**

When indicated, start 24–72 h after chemotherapy  
 Continue until absolute neutrophil count is 10,000/mL  
 Do not use concurrently with chemotherapy or radiation therapy

**Note:** G-CSF, granulocyte colony-stimulating factor; GM-CSF, granulocyte-macrophage colony-stimulating factor.

**Source:** From the American Society of Clinical Oncology.

thrombocytopenic but not stressed or bleeding). In contrast, patients with myeloproliferative states may have functionally altered platelets despite normal platelet counts, and transfusion with normal donor platelets should be considered for evidence of bleeding in these patients. Careful review of medication lists to prevent exposure to nonsteroidal anti-inflammatory agents and maintenance of clotting factor levels adequate to support near-normal prothrombin and partial thromboplastin time tests are important in minimizing the risk of bleeding in the thrombocytopenic patient.

Certain cytokines in clinical investigation have shown an ability to increase platelets (e.g., IL-6, IL-1, thrombopoietin), but clinical benefit and safety are not yet proven. IL-11 (oprelvekin) is approved for use in the setting of expected thrombocytopenia, but its effects on platelet counts are small, and it is associated with side effects such as headache, fever, malaise, syncope, cardiac arrhythmias, and fluid retention.

Anemia associated with chemotherapy can be managed by transfusion of packed RBCs. Transfusion is not undertaken until the hemoglobin falls to  $<80$  g/L

(8 g/dL) or if compromise of end-organ function occurs or an underlying condition (e.g., coronary artery disease) calls for maintenance of hemoglobin >90 g/L (9 g/dL). Patients who are to receive therapy for >2 months on a “stable” regimen and who are likely to require continuing transfusions are also candidates for EPO to maintain hemoglobin of 90–100 g/L (9–10 g/dL). In the setting of adequate iron stores and serum EPO levels <100 ng/mL, EPO, 150 units three times a week, can produce a slow increase in hemoglobin over about 2 months of administration. Depot formulations can be administered less frequently. It is unclear whether higher hemoglobin levels, up to 110–120 g/L (11–12 g/dL), are associated with improved quality of life to a degree that justifies the more intensive EPO use. Efforts to achieve levels at or above 120 g/L (12 g/dL) have been associated with increased thromboses and mortality. EPO may rescue hypoxic cells from death and contribute to tumor radioresistance. This may be a disadvantage in cancer but a great advantage in the setting of heart attacks and strokes.

### **Nausea and Vomiting**

The most common side effect of chemotherapy administration is nausea, with or without vomiting. Nausea may be acute (within 24 h of chemotherapy), delayed (>24 h), or anticipatory of the receipt of chemotherapy. Patients may be likewise stratified for their risk of susceptibility to nausea and vomiting, with increased risk in young, female, heavily pretreated patients without a history of alcohol or drug use but with a history of motion or morning sickness. Antineoplastic agents vary in their capacity to cause nausea and vomiting. Highly emetogenic drugs (>90%) include mechlorethamine, streptozotocin, DTIC, cyclophosphamide at >1500 mg/m<sup>2</sup>, and cisplatin; moderately emetogenic drugs (30–90% risk) include carboplatin, cytosine arabinoside (>1 mg/m<sup>2</sup>), ifosfamide, conventional-dose cyclophosphamide, and anthracyclines; low-risk (10–30%) agents include fluorouracil, taxanes, etoposide, and bortezomib, with minimal risk (<10%) afforded by treatment with antibodies, bleomycin, busulfan, fludarabine, and vinca alkaloids. *Emesis* is a reflex caused by stimulation of the vomiting center in the medulla. Input to the vomiting center comes from the chemoreceptor trigger zone (CTZ) and afferents from the peripheral gastrointestinal tract, cerebral cortex, and heart. The different emesis “syndromes” require distinct management approaches. In addition, a conditioned reflex may contribute to anticipatory nausea arising after repeated cycles of chemotherapy. Accordingly, antiemesis agents differ in their locus and timing of action. Combining agents from different classes or the sequential use of different classes of agent is the cornerstone of successful management of chemotherapy-induced nausea and

vomiting. Of great importance are the prophylactic administration of agents and such psychological techniques as the maintenance of a supportive milieu, counseling, and relaxation to augment the action of antiemetic agents.

Serotonin antagonists (5HT<sub>3</sub>) and neurokinin (NK<sub>1</sub>) receptor antagonists are useful in “high-risk” chemotherapy regimens. The combination acts at both peripheral gastrointestinal as well as CNS sites that control nausea and vomiting. For example, the 5HT<sub>3</sub> blocker dolasetron (Anzemet), 100 mg IV or PO; dexamethasone, 12 mg; and the NK<sub>1</sub> antagonist aprepitant, 125 mg PO, are combined on the day of administration of severely emetogenic regimens, with repetition of dexamethasone (8 mg) and aprepitant (80 mg) on days 2 and 3 for delayed nausea. Alternate 5HT<sub>3</sub> antagonists include ondansetron (Zofran), given as 0.15 mg/kg intravenously for three doses just before and at 4 and 8 h after chemotherapy; palonosetron (Aloxi) at 0.25 mg over 30 s, 30 min prechemotherapy; and granisetron (Kytril), given as a single dose of 0.01 mg/kg just before chemotherapy. Emesis from moderately emetic chemotherapy regimens may be prevented with a 5HT<sub>3</sub> antagonist and dexamethasone alone for patients not receiving doxorubicin and cyclophosphamide combinations; the latter combination requires the 5HT<sub>3</sub>/dexamethasone/aprepitant on day 1 but aprepitant alone on days 2 and 3. Emesis from low-emetic-risk regimens may be prevented with 8 mg of dexamethasone alone, or with non-5HT<sub>3</sub>, non-NK<sub>1</sub> antagonist approaches including the following.

Antidopaminergic phenothiazines act directly at the CTZ and include prochlorperazine (Compazine), 10 mg IM or IV, 10–25 mg orally or 25 mg per rectum every 4–6 h for up to four doses; and thiethylperazine (Torecan), 10 mg by potentially all the above routes every 6 h. Haloperidol (Haldol) is a butyrophenone dopamine antagonist given at 0.5–1.0 mg IM or PO every 8 h. Antihistamines such as diphenhydramine (Benadryl) have little intrinsic antiemetic capacity but are frequently given to prevent or treat dystonic reactions that can complicate use of the antidopaminergic agents. Lorazepam (Ativan) is a short-acting benzodiazepine that provides an anxiolytic effect to augment the effectiveness of a variety of agents when used at 1–2 mg IM, IV, or PO every 4–6 h. Metoclopramide (Reglan) acts on peripheral dopamine receptors to augment gastric emptying and is used in high doses for highly emetogenic regimens (1–2 mg/kg IV 30 min before chemotherapy and every 2 h for up to three additional doses as needed); IV doses of 10–20 mg every 4–6 h as needed or 50 mg orally 4 h before and 8 and 12 h after chemotherapy are used for moderately emetogenic regimens.

5-9-Tetrahydrocannabinol (Marinol) is a rather weak antiemetic compared to other available agents, but it may be useful for persisting nausea and is used orally at 10 mg every 3–4 h as needed.

Regimens that include fluorouracil infusions and/or irinotecan may produce severe diarrhea. Similar to the vomiting syndromes, chemotherapy-induced diarrhea may be immediate or can occur in a delayed fashion up to 48–72 h after the drugs. Careful attention to maintained hydration and electrolyte repletion, intravenously if necessary, along with antimotility treatments such as “high-dose” loperamide, commenced with 4 mg at the first occurrence of diarrhea, with 2 mg repeated every 2 h until 12 h without loose stools. Octreotide (100–150 µg), a somatostatin analog, or opiate-based preparations may be considered for patients not responding to loperamide.

### **Mucositis**

Irritation and inflammation of the mucous membranes particularly afflicting the oral and anal mucosa, but potentially involving the gastrointestinal tract, may accompany cytotoxic chemotherapy. Mucositis is due to damage to the proliferating cells at the base of the mucosal squamous epithelia or in the intestinal crypts. Topical therapies, including anesthetics and barrier-creating preparations, may provide symptomatic relief in mild cases. Palifermin or keratinocyte growth factor, a member of the fibroblast growth factor family, is effective in preventing severe mucositis in the setting of high-dose chemotherapy with stem cell transplantation for hematologic malignancies. It may also prevent mucositis from radiation.

### **Alopecia**

Chemotherapeutic agents vary widely in causing alopecia, with anthracyclines, alkylating agents, and topoisomerase inhibitors reliably causing near-total alopecia when given at therapeutic doses. Antimetabolites are more variably associated with alopecia. Psychological support and the use of cosmetic resources are to be encouraged, and “chemo caps” that reduce scalp temperature to decrease the degree of alopecia should be discouraged, particularly during treatment with curative intent of neoplasms such as leukemia or lymphoma, or in adjuvant breast cancer therapy. The richly vascularized scalp can certainly harbor micrometastatic or disseminated disease.

### **Gonadal Dysfunction and Pregnancy**

Cessation of ovulation and azoospermia reliably result from alkylating agent- and topoisomerase poison-containing regimens. The duration of these effects varies with age and sex. Males treated for Hodgkin’s disease with mechlorethamine- and procarbazine-containing regimens are effectively sterile, whereas fertility usually returns after regimens that include cisplatin, vinblastine, or etoposide and after bleomycin for testicular cancer.

Sperm banking before treatment may be considered to support patients likely to be sterilized by treatment. Females experience amenorrhea with anovulation after alkylating agent therapy; they are likely to recover normal menses if treatment is completed before age 30 but unlikely to recover menses after age 35. Even those who regain menses usually experience premature menopause. Because the magnitude and extent of decreased fertility can be difficult to predict, patients should be counseled to maintain effective contraception, preferably by barrier means, during and after therapy. Resumption of efforts to conceive should be considered in the context of the patient’s likely prognosis. Hormone replacement therapy should be undertaken in women who do not have a hormonally responsive tumor. For those patients who have had a hormone-sensitive tumor primarily treated by a local modality, conventional practice would counsel against hormone replacement, but this issue is under investigation.

Chemotherapy agents have variable effects on the success of pregnancy. All agents tend to have increased risk of adverse outcomes when administered during the first trimester, and strategies to delay chemotherapy, if possible, until after this milestone should be considered if the pregnancy is to continue to term. Patients in their second or third trimester can be treated with most regimens for the common neoplasms afflicting women in their childbearing years, with the exception of antimetabolites, particularly antifolates, which have notable teratogenic or fetotoxic effects throughout pregnancy. The need for anticancer chemotherapy per se is infrequently a clear basis to recommend termination of a concurrent pregnancy, although each treatment strategy in this circumstance must be tailored to the individual needs of the patient. Chronic effects of cancer treatment are reviewed in Chap. 52.

## **BIOLOGIC THERAPY**

The goal of biologic therapy is to manipulate the host-tumor interaction in favor of the host. Theoretically, biologic approaches should reflect a bell-shaped dose-response curve where the maximum biologic effect is less than the MTD. However, empirical trial and error has led to the discovery that a number of biologic treatment approaches may produce antitumor effects, but nearly all of them are most active at their MTD. As a class, biologic therapies may be distinguished from molecularly targeted agents in that many biologic therapies require an active response (e.g., reexpression of silenced genes, or antigen expression) on the part of the tumor cell or on the part of the host (e.g., immunologic effects) to allow therapeutic effect. This may be contrasted with the more narrowly defined antiproliferative or apoptotic response that is the ultimate goal of the molecularly targeted agents discussed earlier. However,

there is much commonality in the strategies to evaluate and use molecularly targeted and biologic therapies.

## IMMUNE MEDIATORS OF ANTITUMOR EFFECTS

The very existence of a cancer in a person is testimony to the failure of the immune system to deal effectively with the cancer. Tumors have a variety of means of avoiding the immune system: (1) they are often only subtly different from their normal counterparts; (2) they are capable of downregulating their major histocompatibility complex antigens, effectively masking them from recognition by T cells; (3) they are inefficient at presenting antigens to the immune system; (4) they can cloak themselves in a protective shell of fibrin to minimize contact with surveillance mechanisms; and (5) they can produce a range of soluble molecules, including potential immune targets, that can distract the immune system from recognizing the tumor cell or can kill the immune effector cells. Some of the cell products initially polarize the immune response away from cellular immunity (shifting from  $T_H1$  to  $T_H2$  responses;) and ultimately lead to defects in T cells that prevent their activation and cytotoxic activity. Cancer treatment further suppresses host immunity. A variety of strategies are being tested to overcome these barriers.

### Cell-Mediated Immunity

The strongest evidence that the immune system can exert clinically meaningful antitumor effects comes from allogeneic bone marrow transplantation. Adoptively transferred T cells from the donor expand in the tumor-bearing host, recognize the tumor as foreign, and can mediate impressive antitumor effects (graft-versus-tumor effects). Three types of experimental interventions are being developed to take advantage of the ability of T cells to kill tumor cells.

1. Allogeneic T cells are transferred to cancer-bearing hosts in three major settings: in the form of allogeneic bone marrow transplantation, as pure lymphocyte transfusions following bone marrow recovery after allogeneic bone marrow transplantation, and as pure lymphocyte transfusions following immunosuppressive (but not myeloablative) therapy (so-called mini-transplants). In each of these settings, the effector cells are donor T cells that recognize the tumor as being foreign, probably through minor histocompatibility differences. The main risk of such therapy is the development of graft-versus-host disease because of the minimal difference between the cancer and the normal host cells. This approach has been highly effective in certain hematologic cancers.
2. Autologous T cells are removed from the tumor-bearing host, manipulated in several ways in vitro,

and given back to the patient. The two major classes of autologous T cell manipulation are (a) to develop tumor antigen-specific T cells and expand them to large numbers over many weeks *ex vivo* before administration, and (b) to activate the cells with polyclonal stimulators such as anti-CD3 and anti-CD28 after a short period *ex vivo* and try to expand them in the host after adoptive transfer with stimulation by IL-2, for example. Short periods removed from the patient permit the cells to overcome the tumor-induced T cell defects, and such cells traffic and home to sites of disease better than cells that have been in culture for many weeks. Individual centers have successful experiences with one or the other approach but not both, and whether one is superior to the other is not known.

3. Tumor vaccines are aimed at boosting T cell immunity. The finding that mutant oncogenes that are expressed only intracellularly can be recognized as targets of T cell killing greatly expanded the possibilities for tumor vaccine development. No longer is it difficult to find something different about tumor cells. However, major difficulties remain in getting the tumor-specific peptides presented in a fashion to prime the T cells. Tumors themselves are very poor at presenting their own antigens to T cells at the first antigen exposure (*priming*). Priming is best accomplished by professional antigen-presenting cells (dendritic cells). Thus a number of experimental strategies are aimed at priming host T cells against tumor-associated peptides. Vaccine adjuvants such as GM-CSF appear capable of attracting antigen-presenting cells to a skin site containing a tumor antigen. Such an approach has been documented to eradicate microscopic residual disease in follicular lymphoma and give rise to tumor-specific T cells. Purified antigen-presenting cells can be pulsed with tumor, its membranes, or particular tumor antigens and delivered as a vaccine. Tumor cells can be transfected with genes that attract antigen-presenting cells. Other ideas are also being tested. In a variation on the theme of adoptive transfer, the tumor vaccine may be given to the normal bone marrow and lymphoid cell donor of an allogeneic transplant so that the donor immune system has more cells capable of recognizing the tumor specifically. Vaccines against viruses that cause cancers are safe and effective. Hepatitis B vaccine prevents hepatocellular carcinoma, and a tetravalent human papilloma virus vaccine prevents infection by virus types currently accounting for 70% of cervical cancer. These vaccines are ineffective at treating patients who have developed a virus-induced cancer. Investigational vaccines have shown preliminary evidence of activity against multiple myeloma, certain lymphomas, and melanomas.

In general, antibodies are not very effective at killing cancer cells. Because the tumor seems to influence the host toward making antibodies rather than generating cellular immunity, it is inferred that antibodies are easier for the tumor to fend off. Many patients can be shown to have serum antibodies directed at their tumors, but these do not appear to influence disease progression. However, the ability to grow very large quantities of high-affinity antibody directed at a tumor by the hybridoma technique has led to the application of antibodies to the treatment of cancer.

Clinical antitumor efficacy has been obtained using antibodies where the antigen-combining regions are grafted onto human immunoglobulin gene products (chimerized or humanized), or derive de novo from mice bearing human immunoglobulin gene loci. Such humanized antibodies against the CD20 molecule expressed on B cell lymphomas (rituximab) and against the HER-2/neu receptor overexpressed on epithelial cancers, especially breast cancer (trastuzumab), have become reliable tools in the oncologist's armamentarium. Each used alone can cause tumor regression (rituximab more than trastuzumab), and both appear to potentiate the effects of combination chemotherapy given just after antibody administration. Antibodies to CD52 are active in chronic lymphoid leukemia and T cell malignancies. EGF-R-directed antibodies (such as cetuximab and panitumumab) have activity in colorectal cancer refractory to chemotherapy, particularly when used to augment the activity of an additional chemotherapy program, and in the primary treatment of head and neck cancers treated with radiation therapy. The mechanism of action is unclear. Direct effects on the tumor may mediate an antiproliferative effect as well as stimulate the participation of host mechanisms involving immune cell or complement-mediated response to tumor cell-bound antibody. Alternatively, the antibody may alter the release of paracrine factors promoting tumor cell survival.

The anti-VEGF antibody bevacizumab shows little evidence of antitumor effect when used alone, but when combined with chemotherapeutic agents it improves the magnitude of tumor shrinkage and time to disease progression in colorectal, lung, and breast cancer. The mechanism for the effect is unclear and may relate to the capacity of the antibody to alter delivery and tumor uptake of the active chemotherapeutic agent.

Side effects include infusion-related hypersensitivity reactions, usually limited to the first infusion, which can be managed with glucocorticoid and/or antihistamine prophylaxis. In addition, distinct syndromes have emerged with different antibodies. Anti-EGF-R antibodies produce an acneiform rash that poorly responds to steroid cream treatment. Trastuzumab (anti-HER-2)

can inhibit cardiac function, particularly in those patients with prior exposure to anthracyclines. Bevacizumab has a number of side effects of medical significance, including hypertension, proteinuria, hemorrhage, and gastrointestinal perforations with or without prior surgeries.

Conjugation of antibodies to drugs and toxins was discussed earlier; conjugates of antibodies with isotopes, photodynamic agents, and other killing moieties may also be effective. Radioconjugates targeting CD20 on lymphomas have been approved for use [ibrutinomab tiuxetan (Zevalin), using yttrium-90 or <sup>131</sup>I-tositumomab]. Other conjugates are associated with problems that have not yet been solved (e.g., antigenicity, instability, poor tumor penetration).

### **Cytokines**

There are >70 separate proteins and glycoproteins with biologic effects in humans: interferon (IFN)  $\alpha$ ,  $\beta$ ,  $\gamma$ ; IL-1 through -29 (so far); the tumor necrosis factor (TNF) family [including lymphotoxin, TNF-related apoptosis-inducing ligand (TRAIL), CD40 ligand, and others]; and the chemokine family. Only a fraction of these has been tested against cancer; only IFN- $\alpha$  and IL-2 are in routine clinical use.

About 20 different genes encode IFN- $\alpha$ , and their biologic effects are indistinguishable. Interferon induces the expression of many genes, inhibits protein synthesis, and exerts a number of different effects on diverse cellular processes. Its antitumor effects appear to be antagonized in vitro by thymidine, suggesting that de novo thymidylate synthesis is also affected. The two recombinant forms that are commercially available are IFN- $\alpha$ 2a and - $\alpha$ 2b. In general, interferon antitumor effects are dose-related, and IFN is most effective at its MTD. Interferon is not curative for any tumor but can induce partial responses in follicular lymphoma, hairy cell leukemia, CML, melanoma, and Kaposi's sarcoma. It has been used in the adjuvant setting in stage II melanoma, multiple myeloma, and follicular lymphoma, with uncertain effects on survival. It produces fever, fatigue, a flulike syndrome, malaise, myelosuppression, and depression and can induce clinically significant autoimmune disease.

IL-2 must exert its antitumor effects indirectly through augmentation of immune function. Its biologic activity is to promote the growth and activity of T cells and natural killer (NK) cells. High doses of IL-2 can produce tumor regression in certain patients with metastatic melanoma and renal cell cancer. About 2-5% of patients may experience complete remissions that are durable, unlike any other treatment for these tumors. IL-2 is associated with myriad clinical side effects: intravascular volume depletion, capillary leak syndrome, adult respiratory distress syndrome, hypotension, fever,

chills, skin rash, and impaired renal and liver function. Patients may require blood pressure support and intensive care to manage the toxicity. However, once the agent is stopped, most of the toxicities reverse completely within 3–6 days.

## GENE THERAPIES

No gene therapy has been approved for routine clinical use. Several strategies are under evaluation, including the use of viruses that cannot replicate to express genes that can allow the action of drugs or directly inhibit cancer cell growth, viruses that can actually replicate but only in the context of the tumor cell, or viruses that can express antigens in the context of the tumor and therefore provoke a host-mediated immune response. Key issues in the success of these approaches will be in defining safe viral vector systems that escape host immune function and effectively target the tumor or tumor cell milieu. Other gene therapy strategies would use therapeutic oligonucleotides to target the expression of genes important in the maintenance of tumor cell viability.

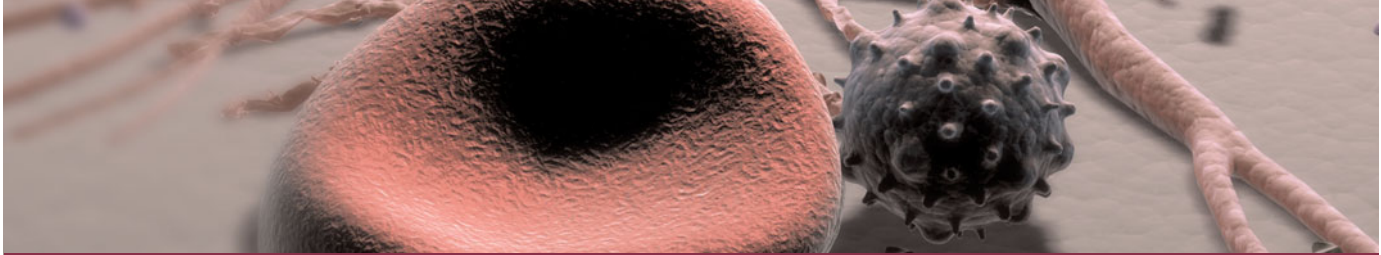
### ACKNOWLEDGMENT

*Stephen M. Hahn, MD, and Eli Glatstein, MD, contributed a chapter on radiation therapy in the prior edition of Harrison's*

*Principles of Internal Medicine, and some of their material has been incorporated into this chapter.* 373

## FURTHER READINGS

- AMERICAN SOCIETY OF CLINICAL ONCOLOGY: 2006 Update of recommendations for the use of white blood cell growth factors: An evidence-based clinical practice guideline. *J Clin Oncol* 24:3187, 2006
- : Guideline for antiemetics in oncology: Update 2006. *J Clin Oncol* 24:2932, 2006
- CHABNER BA, LONGO DL (eds): *Cancer Chemotherapy and Biotherapy: Principles and Practice*, 4th ed. Philadelphia, Lippincott Williams & Wilkins, 2006
- FOLKMAN J: Angiogenesis: An organizing principle for drug discovery? *Nat Rev Drug Discov* 6:273, 2007
- FORMENTI SC, DEMARIA S: Systemic effects of local radiotherapy. *Lancet Oncol* 10:718, 2009
- KRAUSE DS, VAN ETTEN RA: Tyrosine kinases as targets for cancer therapy. *N Engl J Med* 353:17, 2005
- LAPENNA S, GIORDANO A: Cell cycle kinases as therapeutic targets for cancer. *Nat Rev Drug Discov* 8:547, 2009
- O'CONNOR R: A review of mechanisms of circumvention and modulation of chemotherapeutic drug resistance. *Curr Cancer Drug Targets* 9:273, 2009
- O'DONNELL PH, DOLAN ME: Cancer pharmacoethnicity: Ethnic differences in susceptibility to the effects of chemotherapy. *Clin Cancer Res* 15:4806, 2009



## CHAPTER 28

# INFECTIONS IN PATIENTS WITH CANCER

Robert Finberg

■ System-Specific Syndromes . . . . .	.377	■ Abnormalities That Predispose to Infection . . . . .	.383
Skin-Specific Syndromes . . . . .	.377	The Lymphoid System . . . . .	.383
Catheter-Related Infections . . . . .	.378	The Hematopoietic System . . . . .	.383
Gastrointestinal Tract–Specific Syndromes . . . . .	.378	■ Prevention of Infection in Cancer Patients . . . . .	.386
Central Nervous System–Specific		Effect of the Environment . . . . .	.386
Syndromes . . . . .	.380	Physical Measures . . . . .	.386
Pulmonary Infections . . . . .	.380	Immunoglobulin Replacement . . . . .	.387
Cardiovascular Infections . . . . .	.382	Sexual Practices . . . . .	.387
Endocrine Syndromes . . . . .	.382	Antibiotic Prophylaxis . . . . .	.387
Musculoskeletal Infections . . . . .	.382	Vaccination of Cancer Patients . . . . .	.387
Renal and Ureteral Infections . . . . .	.383	■ Further Readings . . . . .	.387

Infections are a common cause of death and an even more common cause of morbidity in patients with a wide variety of neoplasms. Autopsy studies show that most deaths from acute leukemia and half of the deaths from lymphoma are caused directly by infection. With more intensive chemotherapy, patients with solid tumors have also become more likely to die of infection. Fortunately, an evolving approach to prevention and treatment of infectious complications of cancer has decreased rates of infection-associated mortality and will probably continue to do so. This accomplishment has resulted from three major steps:

1. The concept of “early empirical” antibiotics reduced mortality rates among patients with leukemia and bacteremia from 84% in 1965 to 44% in 1972. With better availability (and early use) of broad-spectrum antibiotics, this figure has recently dropped to 20–36%.
2. “Empirical” antifungal therapy has lowered the incidence of disseminated fungal infection; in trial settings, mortality rates now range from 7–21%. An antifungal agent is administered—on the basis of likely fungal infection—to neutropenic patients who, after 4–7 days of antibiotic therapy, remain febrile but have no positive cultures.
3. Use of antibiotics for afebrile neutropenic patients as broad-spectrum prophylaxis against infections promises to decrease both mortality and morbidity even further.

A physical predisposition to infection in patients with cancer (**Table 28-1**) can be a result of the neoplasm’s production of a break in the skin. For example, a squamous cell carcinoma may cause local invasion of the epidermis, which allows bacteria to gain access to the subcutaneous tissue and permits the development of cellulitis. The artificial closing of a normally patent orifice can also predispose to infection: Obstruction of a ureter by a tumor can cause urinary tract infection, and obstruction of the bile duct can cause cholangitis. Part of the host’s normal defense against infection depends on the continuous emptying of a viscus; without emptying, a few bacteria present as a result of bacteremia or local transit can multiply and cause disease.

A similar problem can affect patients whose lymph node integrity has been disrupted by radical surgery, particularly patients who have had radical node dissections. A common clinical problem following radical mastectomy is the development of cellulitis (usually caused by streptococci or staphylococci) because of lymphedema and/or inadequate lymph drainage. In most cases, this problem can be addressed by local measures designed to prevent fluid accumulation and breaks in the skin, but antibiotic prophylaxis has been necessary in refractory cases.

A life-threatening problem common to many cancer patients is the loss of the reticuloendothelial capacity to

TABLE 28-1

## DISRUPTION OF NORMAL BARRIERS THAT MAY PREDISPOSE TO INFECTIONS IN PATIENTS WITH CANCER

TYPE OF DEFENSE	SPECIFIC LESION	CELLS INVOLVED	ORGANISM	CANCER ASSOCIATION	DISEASE
Physical barrier	Breaks in skin	Skin epithelial cells	Staphylococci, streptococci	Head and neck, squamous cell carcinoma	Cellulitis, extensive skin infection
Emptying of fluid collections	Occlusion of orifices: ureters, bile duct, colon	Luminal epithelial cells	Gram-negative bacilli	Renal, ovarian, biliary tree, metastatic diseases of many cancers	Rapid, overwhelming bacteremia; urinary tract infection
Lymphatic function	Node dissection	Lymph nodes	Staphylococci, streptococci	Breast cancer surgery	Cellulitis
Splenic clearance of microorganisms	Splenectomy	Splenic reticuloendothelial cells	<i>Streptococcus pneumoniae</i> , <i>Haemophilus influenzae</i> , <i>Neisseria meningitidis</i> , <i>Babesia</i> , <i>Capnocytophaga canimorsus</i>	Hodgkin's disease, leukemia, idiopathic thrombocytopenic purpura	Rapid, overwhelming sepsis
Phagocytosis	Lack of granulocytes	Granulocytes (neutrophils)	Staphylococci, streptococci, enteric organisms, fungi	Hairy cell, acute myelocytic, and acute lymphocytic leukemias	Bacteremia
Humoral immunity	Lack of antibody	B cells	<i>S. pneumoniae</i> , <i>H. influenzae</i> , <i>N. meningitidis</i>	Chronic lymphocytic leukemia, multiple myeloma	Infections with organisms, sinusitis, pneumonia
Cellular immunity	Lack of T cells	T cells and macrophages	<i>Mycobacterium tuberculosis</i> , <i>Listeria</i> , herpesviruses, fungi, other intracellular parasites	Hodgkin's disease, leukemia, T cell lymphoma	Infections with intracellular bacteria, fungi, parasites

clear microorganisms after splenectomy. Splenectomy may be performed as part of the management of hairy cell leukemia, chronic lymphocytic leukemia (CLL), and chronic myelocytic leukemia (CML) and in Hodgkin's disease. Even after curative therapy for the underlying disease, the lack of a spleen predisposes such patients to rapidly fatal infections. The loss of the spleen through trauma similarly predisposes the normal host to overwhelming infection for life after splenectomy. The splenectomized patient should be counseled about the risks of infection with certain organisms, such as the protozoan *Babesia* and *Capnocytophaga canimorsus* (formerly dysgonic fermenter 2, or DF-2), a bacterium carried in the mouths of animals. Because encapsulated bacteria (*Streptococcus pneumoniae*, *Haemophilus influenzae*, and *Neisseria meningitidis*) are the organisms most commonly associated with postsplenectomy sepsis, splenectomized persons should be vaccinated (and revaccinated; [Table 28-2](#)) against the capsular polysaccharides of these organisms. Many clinicians recommend giving splenectomized

patients a small supply of antibiotics effective against *S. pneumoniae*, *N. meningitidis*, and *H. influenzae* to avert rapid, overwhelming sepsis in the event that they cannot present for medical attention immediately after the onset of fever or other symptoms of bacterial infection. A few amoxicillin/clavulanic acid tablets are a reasonable choice for this purpose.

The level of suspicion of infections with certain organisms should depend on the type of cancer diagnosed ([Table 28-3](#)). Diagnosis of multiple myeloma or CLL should alert the clinician to the possibility of hypogammaglobulinemia. Although immunoglobulin replacement therapy can be effective, in most cases prophylactic antibiotics are a cheaper, more convenient method of eliminating bacterial infections in CLL patients with hypogammaglobulinemia. Patients with acute lymphocytic leukemia (ALL), patients with non-Hodgkin's lymphoma, and all cancer patients treated with high-dose glucocorticoids (or glucocorticoid-containing chemotherapy regimens) should receive antibiotic prophylaxis for *Pneumocystis*



## VACCINATION OF CANCER PATIENTS RECEIVING CHEMOTHERAPY

VACCINE	USE IN INDICATED PATIENTS		
	INTENSIVE CHEMOTHERAPY	HODGKIN'S DISEASE	HEMATOPOIETIC STEM CELL TRANSPLANTATION
Diphtheria-tetanus <sup>a</sup>	Primary series and boosters as necessary	No special recommendation	12, 14, and 24 months after transplantation
Poliomyelitis <sup>b</sup>	Complete primary series and boosters	No special recommendation	12, 14, and 24 months after transplantation
<i>Haemophilus influenzae</i> type b conjugate	Primary series and booster for children	Immunization before treatment and booster 3 months afterward	12, 14, and 24 months after transplantation
Hepatitis A	Not routinely recommended	Not routinely recommended	Not routinely recommended
Hepatitis B	Complete series	No special recommendation	12, 14, and 24 months after transplantation
23-Valent pneumococcal polysaccharide <sup>c</sup>	Every 5 years	Immunization before treatment and booster 3 months afterward	12 and 24 months after transplantation
4-Valent meningococcal conjugate <sup>d</sup>	Should be administered to splenectomized patients and patients living in endemic areas, including college students in dormitories	Should be administered to splenectomized patients and patients living in endemic areas, including college students in dormitories	Should be administered to splenectomized patients and patients living in endemic areas, including college students in dormitories
Influenza	Seasonal immunization	Seasonal immunization	Seasonal immunization
Measles/mumps/rubella	Contraindicated	Contraindicated during chemotherapy	After 24 months in patients without graft-versus-host disease
Varicella-zoster virus	Contraindicated <sup>e</sup>	Contraindicated	Contraindicated

<sup>a</sup>The Td (tetanus-diphtheria) combination is currently recommended for adults. Pertussis vaccines have not been recommended for people >6 years of age in the past. However, recent data indicate that the Tdap (tetanus-diphtheria-acellular pertussis) product is both safe and efficacious in adults.

<sup>b</sup>Live-virus vaccine is contraindicated; inactivated vaccine should be used.

<sup>c</sup>The seven-serotype pneumococcal conjugate vaccine is currently recommended only for children. It is anticipated that future vaccines will include more serotypes and will be recommended for adults.

<sup>d</sup>Currently licensed for people 11–55 years of age.

<sup>e</sup>Contact the manufacturer for more information on use in children with acute lymphocytic leukemia.

TABLE 28-3

## INFECTIONS ASSOCIATED WITH SPECIFIC TYPES OF CANCER

CANCER	UNDERLYING IMMUNE ABNORMALITY	ORGANISMS CAUSING INFECTION
Multiple myeloma	Hypogammaglobulinemia	<i>Streptococcus pneumoniae</i> , <i>Haemophilus influenzae</i> , <i>Neisseria meningitidis</i>
Chronic lymphocytic leukemia	Hypogammaglobulinemia	<i>S. pneumoniae</i> , <i>H. influenzae</i> , <i>N. meningitidis</i>
Acute myelocytic or lymphocytic leukemia	Granulocytopenia, skin and mucous-membrane lesions	Extracellular gram-positive and gram-negative bacteria, fungi
Hodgkin's disease	Abnormal T cell function	Intracellular pathogens ( <i>Mycobacterium tuberculosis</i> , <i>Listeria</i> , <i>Salmonella</i> , <i>Cryptococcus</i> , <i>Mycobacterium avium</i> ) <i>Pneumocystis</i>
Non-Hodgkin's lymphoma and acute lymphocytic leukemia	Glucocorticoid chemotherapy, T and B cell dysfunction	
Colon and rectal tumors	Local abnormalities <sup>a</sup>	<i>Streptococcus bovis</i> (bacteremia)
Hairy cell leukemia	Abnormal T cell function	Intracellular pathogens ( <i>M. tuberculosis</i> , <i>Listeria</i> , <i>Cryptococcus</i> , <i>M. avium</i> )

<sup>a</sup>The reason for this association is not well defined.

infection (Table 28-3) for the duration of their chemotherapy. In addition to exhibiting susceptibility to certain infectious organisms, patients with cancer are likely to manifest their infections in characteristic ways.

## SYSTEM-SPECIFIC SYNDROMES

### SKIN-SPECIFIC SYNDROMES

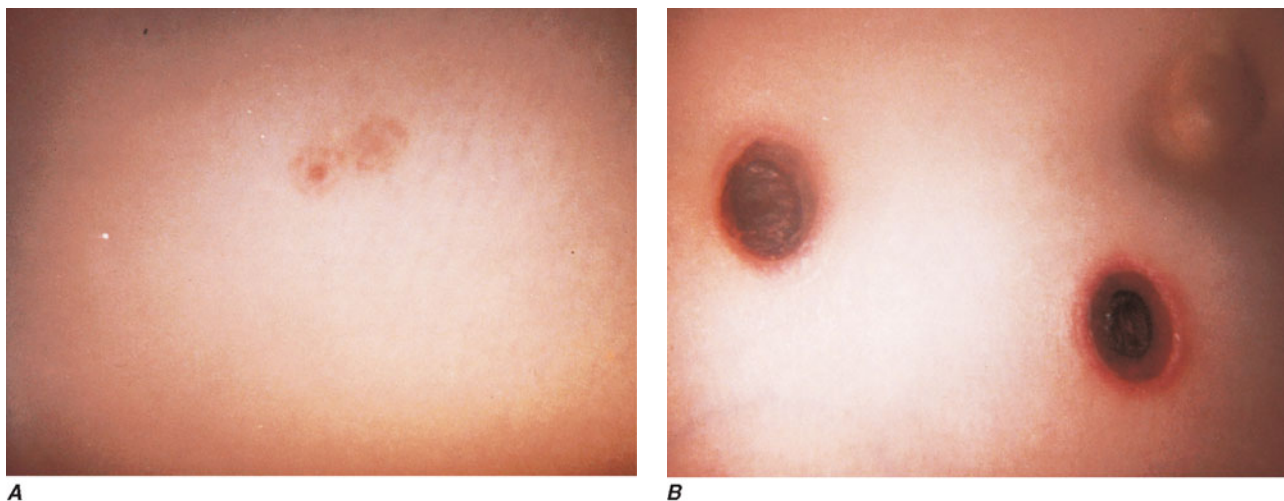
Skin lesions are common in cancer patients, and the appearance of these lesions may permit the diagnosis of systemic bacterial or fungal infection. Although cellulitis caused by skin organisms such as *Streptococcus* or *Staphylococcus* is common, neutropenic patients—i.e., those with <500 functional polymorphonuclear leukocytes (PMNs)/ $\mu\text{L}$ —and patients with impaired blood or lymphatic drainage may develop infections with unusual organisms. Innocent-looking macules or papules may be the first sign of bacterial or fungal sepsis in immunocompromised patients (Fig. 28-1). In the neutropenic host, a macule progresses rapidly to ecthyma gangrenosum, a usually painless, round, necrotic lesion consisting of a central black or gray-black eschar with surrounding erythema. Ecthyma gangrenosum, which is located in nonpressure areas (as distinguished from necrotic lesions associated with lack of circulation), is often associated with *Pseudomonas aeruginosa* bacteremia but may be caused by other bacteria.

Candidemia is also associated with a variety of skin conditions and commonly presents as a maculopapular rash. Punch biopsy of the skin may be the best method for diagnosis.

*Cellulitis*, an acute spreading inflammation of the skin, is most often caused by infection with group A *Streptococcus* or *Staphylococcus aureus*, virulent organisms normally

found on the skin. Although cellulitis tends to be circumscribed in normal hosts, it may spread rapidly in neutropenic patients. A tiny break in the skin may lead to spreading cellulitis, which is characterized by pain and erythema; in the affected patients, signs of infection (e.g., purulence) are often lacking. What might be a furuncle in a normal host may require amputation because of uncontrolled infection in a patient presenting with leukemia. A dramatic response to an infection that might be trivial in a normal host can mark the first sign of leukemia. Fortunately, granulocytopenic patients are likely to be infected with certain types of organisms (Table 28-4); thus the selection of an antibiotic regimen is somewhat easier than it might otherwise be (see “Antibacterial Therapy,” later). It is essential to recognize cellulitis early and to treat it aggressively. Patients who are neutropenic or have previously received antibiotics for other reasons may develop cellulitis with unusual organisms (e.g., *Escherichia coli*, *Pseudomonas*, or fungi). Early treatment, even of innocent-looking lesions, is essential to prevent necrosis and loss of tissue. Debridement to prevent spread may sometimes be necessary early in the course of disease, but it can often be performed after chemotherapy, when the PMN count increases.

*Sweet’s syndrome*, or *febrile neutrophilic dermatosis*, was originally described in women with elevated white blood cell (WBC) counts. The disease is characterized by the presence of leukocytes in the lower dermis, with edema of the papillary body. Ironically, this disease now is usually seen in neutropenic patients with cancer, most often in association with acute leukemia but also in association with a variety of other malignancies. Sweet’s syndrome usually presents as red or bluish red papules or nodules that may coalesce and form sharply bordered



**FIGURE 28-1**

**A.** Papules related to *Escherichia coli* bacteremia in a neutropenic patient with acute lymphocytic leukemia. **B.** The same lesion the following day.

**ORGANISMS LIKELY TO CAUSE INFECTIONS  
IN GRANULOCYTOPENIC PATIENTS**

Gram-positive cocci
<i>Staphylococcus epidermidis</i>
<i>Staphylococcus aureus</i>
Viridans <i>Streptococcus</i>
<i>Enterococcus faecalis</i>
<i>Streptococcus pneumoniae</i>
Gram-negative bacilli
<i>Escherichia coli</i>
<i>Klebsiella</i> spp.
<i>Pseudomonas aeruginosa</i>
Non-aeruginosa <i>Pseudomonas</i> spp. <sup>a</sup>
<i>Enterobacter</i> spp.
<i>Serratia</i> spp.
<i>Acinetobacter</i> spp. <sup>a</sup>
<i>Citrobacter</i> spp.
Gram-positive bacilli
Diphtheroids
JK bacillus <sup>a</sup>
Fungi
<i>Candida</i> spp.
<i>Aspergillus</i> spp.

<sup>a</sup>Often associated with intravenous catheters.

plaques. The edema may suggest vesicles, but on palpation the lesions are solid, and vesicles probably never arise in this disease. The lesions are most common on the face, neck, and arms. On the legs, they may be confused with erythema nodosum. The development of lesions is often accompanied by high fevers and an elevated erythrocyte sedimentation rate. Both the lesions and the temperature elevation respond dramatically to glucocorticoid administration. Treatment begins with high doses of glucocorticoids (60 mg/d of prednisone) followed by tapered doses over the next 2–3 weeks.

Data indicate that *erythema multiforme* with mucous membrane involvement is often associated with herpes simplex virus (HSV) infection and is distinct from Stevens-Johnson syndrome, which is associated with drugs and tends to have a more widespread distribution. Because cancer patients are both immunosuppressed (and therefore susceptible to herpes infections) and heavily treated with drugs (and therefore subject to Stevens-Johnson syndrome), both of these conditions are common in this population.

*Cytokines*, which are used as adjuvants or primary treatments for cancer, can themselves cause characteristic rashes, further complicating the differential diagnosis. This phenomenon is a particular problem in bone marrow transplant recipients, who, in addition to having the usual chemotherapy-, antibiotic-, and cytokine-induced rashes, are plagued by graft-versus-host disease.

**CATHETER-RELATED INFECTIONS**

Because IV catheters are commonly used in cancer chemotherapy and are prone to infection, they pose a major problem in the care of patients with cancer. Some catheter-associated infections can be treated with antibiotics; in others the catheter must be removed (Table 28-5). If the patient has a “tunneled” catheter (which consists of an entrance site, a subcutaneous tunnel, and an exit site), a red streak over the subcutaneous part of the line (the tunnel) is grounds for immediate removal of the catheter. Failure to remove catheters under these circumstances may result in extensive cellulitis and tissue necrosis.

More common than tunnel infections are exit-site infections, often with erythema around the area where the line penetrates the skin. Most authorities recommend treatment (usually with vancomycin) for an exit-site infection caused by a coagulase-negative *Staphylococcus*. Treatment of coagulase-positive staphylococcal infection is associated with a poorer outcome, and it is advisable to remove the catheter if possible. Similarly, many clinicians remove catheters associated with infections due to *P. aeruginosa* and *Candida* species because such infections are difficult to treat and bloodstream infections with these organisms are likely to be deadly. Catheter infections caused by *Burkholderia cepacia*, *Stenotrophomonas* spp., *Agrobacterium* spp., and *Acinetobacter baumannii* as well as *Pseudomonas* spp. other than *aeruginosa* are likely to be very difficult to eradicate with antibiotics alone. Similarly, isolation of *Bacillus*, *Corynebacterium*, and *Mycobacterium* spp. should prompt removal of the catheter.

**GASTROINTESTINAL TRACT-SPECIFIC SYNDROMES****Upper Gastrointestinal Tract Disease****Infections of the Mouth**

The oral cavity is rich in aerobic and anaerobic bacteria that normally live in a commensal relationship with the host. The antimetabolic effects of chemotherapy cause a breakdown of host defenses, leading to ulceration of the mouth and the potential for invasion by resident bacteria. Mouth ulcerations afflict most patients receiving chemotherapy and have been associated with viridans streptococcal bacteremia. The use of keratinocyte growth factor (palifermin) in a daily dose of 60 µg/kg for 3 days before chemotherapy and total-body irradiation is of proven value in preventing mucosal ulceration after stem cell transplantation. Fluconazole is clearly effective in the treatment of both local infections (thrush) and systemic infections (esophagitis) due to *Candida albicans*. Newer azoles (such as voriconazole) are similarly effective.

*Noma* (*cancrem oris*), commonly seen in malnourished children, is a penetrating disease of the soft and hard

TABLE 28-5

APPROACH TO CATHETER INFECTIONS IN IMMUNOCOMPROMISED PATIENTS			
CLINICAL PRESENTATION	CATHETER REMOVAL	ANTIBIOTICS	COMMENTS
<b>Evidence of Infection, Negative Blood Cultures</b>			
Exit-site erythema	Not necessary if infection responds to treatment	Usually begin treatment for gram-positive cocci.	Coagulase-negative staphylococci are most common.
Tunnel-site erythema	Required	Treat for gram-positive cocci pending culture results.	Failure to remove the catheter may lead to complications.
<b>Blood Culture–Positive Infections</b>			
Coagulase-negative staphylococci	Line removal optimal but may be unnecessary if patient is clinically stable and responds to antibiotics	Usually start with vancomycin. (Linezolid, quinupristin/dalfopristin, and daptomycin are all appropriate.)	If there are no contraindications to line removal, this course of action is optimal. If the line is removed, antibiotics may not be necessary.
Other gram-positive cocci (e.g., <i>Staphylococcus aureus</i> , <i>Enterococcus</i> ); gram-positive rods ( <i>Bacillus</i> , <i>Corynebacterium</i> spp.)	Recommended	Treat with antibiotics to which the organism is sensitive, with duration based on the clinical setting.	The incidence of metastatic infections following <i>S. aureus</i> infection and the difficulty of treating enterococcal infection make line removal the recommended course of action. In addition, gram-positive rods do not respond readily to antibiotics alone.
Gram-negative bacteria	Recommended	Use an agent to which the organism is shown to be sensitive.	Organisms like <i>Stenotrophomonas</i> , <i>Pseudomonas</i> , and <i>Burkholderia</i> are notoriously hard to treat.
Fungi	Recommended	—	Fungal infections of catheters are extremely difficult to treat.

tissues of the mouth and adjacent sites, with resulting necrosis and gangrene. It has a counterpart in immunocompromised patients and is thought to be due to invasion of the tissues by *Bacteroides*, *Fusobacterium*, and other normal inhabitants of the mouth. Noma is associated with debility, poor oral hygiene, and immunosuppression.

Viruses, particularly HSV, are a prominent cause of morbidity in immunocompromised patients, in whom they are associated with severe mucositis. The use of acyclovir, either prophylactically or therapeutically, is of value.

### Esophageal Infections

The differential diagnosis of esophagitis (usually presenting as substernal chest pain upon swallowing) includes herpes simplex and candidiasis, both of which are readily treatable.

### Lower Gastrointestinal Tract Disease

Hepatic candidiasis results from seeding of the liver (usually from a gastrointestinal source) in neutropenic patients. It is most common in patients being treated for

acute leukemia and usually presents symptomatically around the time the neutropenia resolves. The characteristic picture is that of persistent fever unresponsive to antibiotics; abdominal pain and tenderness or nausea; and elevated serum levels of alkaline phosphatase in a patient with hematologic malignancy who has recently recovered from neutropenia. The diagnosis of this disease (which may present in an indolent manner and persist for several months) is based on the finding of yeasts or pseudohyphae in granulomatous lesions. Hepatic ultrasound or CT may reveal bull's-eye lesions. In some cases, MRI reveals small lesions not visible by other imaging modalities. The pathology (a granulomatous response) and the timing (with resolution of neutropenia and an elevation in granulocyte count) suggest that the host response to *Candida* is an important component of the manifestations of disease. In many cases, although organisms are visible, cultures of biopsied material may be negative. The designation *hepatosplenic candidiasis* or *hepatic candidiasis* is a misnomer because the disease often involves the kidneys and other tissues; the term *chronic disseminated candidiasis* may be more appropriate. Because

380 of the risk of bleeding with liver biopsy, diagnosis is often based on imaging studies (MRI, CT). Amphotericin B is traditionally used for therapy (often for several months, until all manifestations of disease have disappeared), but fluconazole may be useful for outpatient therapy. The use of other antifungal agents and combination therapy is less well studied.

### **Typhlitis**

*Typhlitis* (also referred to as necrotizing colitis, neutropenic colitis, necrotizing enteropathy, ileocecal syndrome, and cecitis) is a clinical syndrome of fever and right-lower-quadrant tenderness in an immunosuppressed host. This syndrome is classically seen in neutropenic patients after chemotherapy with cytotoxic drugs. It may be more common among children than among adults and appears to be much more common among patients with acute myelocytic leukemia (AML) or ALL than among those with other types of cancer; a similar syndrome has been reported in patients infected with HIV type 1. Physical examination reveals right-lower-quadrant tenderness, with or without rebound tenderness. Associated diarrhea (often bloody) is common, and the diagnosis can be confirmed by the finding of a thickened cecal wall on CT, MRI, or ultrasonography. Plain films may reveal a right-lower-quadrant mass, but CT with contrast or MRI is a much more sensitive means of making the diagnosis. Although surgery is sometimes attempted to avoid perforation from ischemia, most cases resolve with medical therapy alone. The disease is sometimes associated with positive blood cultures (which usually yield aerobic gram-negative bacilli), and therapy is recommended for a broad spectrum of bacteria (particularly gram-negative bacilli, which are likely to be found in the bowel flora). Surgery is indicated in the case of perforation.

### **Clostridium difficile–Induced Diarrhea**

Patients with cancer are predisposed to the development of *C. difficile* diarrhea as a consequence of chemotherapy alone. Thus they may have positive toxin tests before receiving antibiotics. Obviously, such patients are also subject to *C. difficile*–induced diarrhea as a result of antibiotic pressure. *C. difficile* should always be considered as a possible cause of diarrhea in cancer patients who have received antibiotics.

## **CENTRAL NERVOUS SYSTEM–SPECIFIC SYNDROMES**

### **Meningitis**

The presentation of meningitis in patients with lymphoma or CLL, patients receiving chemotherapy (particularly with glucocorticoids) for solid tumors, and patients who have received bone marrow transplants

suggests a diagnosis of cryptococcal or listerial infection. As noted previously, splenectomized patients are susceptible to rapid, overwhelming infection with encapsulated bacteria (including *S. pneumoniae*, *H. influenzae*, and *N. meningitidis*). Similarly, patients who are antibody-deficient (such as patients with CLL, those who have received intensive chemotherapy, or those who have undergone bone marrow transplantation) are likely to have infections caused by these bacteria. Other cancer patients, however, because of their defective cellular immunity, are likely to be infected with other pathogens (Table 28–3).

### **Encephalitis**

The spectrum of disease resulting from viral encephalitis is expanded in immunocompromised patients. A predisposition to infections with intracellular organisms similar to those encountered in patients with AIDS is seen in cancer patients receiving (1) high-dose cytotoxic chemotherapy, (2) chemotherapy affecting T cell function (e.g., fludarabine), or (3) antibodies that eliminate T cells (e.g., anti-CD3) or cytokine activity. Infection with varicella-zoster virus (VZV) has been associated with encephalitis that may be caused by VZV-related vasculitis. Chronic viral infections may also be associated with dementia and encephalitic presentations, and a diagnosis of progressive multifocal leukoencephalopathy should be considered when a patient who has received chemotherapy presents with dementia (Table 28–6). Other abnormalities of the central nervous system (CNS) that may be confused with infection include normal-pressure hydrocephalus and vasculitis resulting from CNS irradiation. It may be possible to differentiate these conditions by MRI.

### **Brain Masses**

Mass lesions of the brain most often present as headache with or without fever or neurologic abnormalities. Infections associated with mass lesions may be caused by bacteria (particularly *Nocardia*), fungi (particularly *Cryptococcus* or *Aspergillus*), or parasites (*Toxoplasma*). Epstein-Barr virus (EBV)–associated lymphoproliferative disease may also present as single or multiple mass lesions of the brain. A biopsy may be required for a definitive diagnosis.

## **PULMONARY INFECTIONS**

Pneumonia in immunocompromised patients may be difficult to diagnose because conventional methods of diagnosis depend on the presence of neutrophils. Bacterial pneumonia in neutropenic patients may present without purulent sputum—or, in fact, without any sputum at all—and may not produce physical findings suggestive of chest consolidation (rales or egophony).

TABLE 28-6

**DIFFERENTIAL DIAGNOSIS OF CENTRAL NERVOUS SYSTEM INFECTIONS IN PATIENTS WITH CANCER**

FINDINGS ON CT OR MRI	UNDERLYING PREDISPOSITION	
	PROLONGED NEUTROPENIA	DEFECTS IN CELLULAR IMMUNITY <sup>a</sup>
Mass lesions	<i>Aspergillus</i> brain abscess <i>Nocardia</i> brain abscess <i>Cryptococcus</i> brain abscess	Toxoplasmosis EBV-LPD
Diffuse encephalitis	PML (J-C virus)	Infection with VZV, CMV, HSV, HHV-6, J-C virus (PML), <i>Listeria</i>

<sup>a</sup>High-dose glucocorticoid therapy, cytotoxic chemotherapy.

**Note:** CMV, cytomegalovirus; EBV-LPD, Epstein-Barr virus lymphoproliferative disease; HHV-6, human herpesvirus type 6; HSV, herpes simplex virus; PML, progressive multifocal leukoencephalopathy; VZV, varicella-zoster virus.

In granulocytopenic patients with persistent or recurrent fever, the chest x-ray pattern may help to localize an infection and thus to determine which investigative tests and procedures should be undertaken and which therapeutic options should be considered (Table 28-7). The difficulties encountered in the management of pulmonary infiltrates relate in part to the difficulties of performing diagnostic procedures on the patients involved. When platelet counts can be increased to adequate levels by transfusion, microscopic and microbiologic evaluation of the fluid obtained by endoscopic bronchial lavage is often diagnostic. Lavage fluid should be cultured for *Mycoplasma*, *Chlamydophila*, *Legionella*, *Nocardia*, more common bacterial pathogens, and fungi. In addition, the possibility of *Pneumocystis* pneumonia should

be considered, especially in patients with ALL or lymphoma who have not received prophylactic trimethoprim-sulfamethoxazole (TMP-SMX). The characteristics of the infiltrate may be helpful in decisions about further diagnostic and therapeutic maneuvers. Nodular infiltrates suggest fungal pneumonia (e.g., that caused by *Aspergillus* or *Mucor*). Such lesions may best be approached by visualized biopsy procedures.

*Aspergillus* spp. can colonize the skin and respiratory tract or cause fatal systemic illness. Although *Aspergillus* may cause aspergillomas in a previously existing cavity or may produce allergic bronchopulmonary aspergillosis, the major problem posed by this genus in neutropenic patients is invasive disease due to *A. fumigatus* or *A. flavus*. The organisms enter the host following colonization of the respiratory tract, with subsequent invasion of the blood vessels. The disease is likely to present as a thrombotic or embolic event because of the ability of the organisms to invade blood vessels. The risk of infection with *Aspergillus* correlates directly with the duration of neutropenia. In prolonged neutropenia, positive surveillance cultures for colonization of the nasopharynx with *Aspergillus* may predict the development of disease.

Patients with *Aspergillus* infection often present with pleuritic chest pain and fever, which are sometimes accompanied by cough. Hemoptysis may be an ominous sign. Chest x-rays may reveal new focal infiltrates or nodules. Chest CT may reveal a characteristic halo consisting of a mass-like infiltrate surrounded by an area of low attenuation. The presence of a “crescent sign” on a chest x-ray or a chest CT scan, in which the mass progresses to central cavitation, is characteristic of invasive *Aspergillus* infection but may develop as the lesions are resolving.

In addition to causing pulmonary disease, *Aspergillus* may invade through the nose or palate, with deep sinus penetration. The appearance of a discolored area in the

TABLE 28-7

**DIFFERENTIAL DIAGNOSIS OF CHEST INFILTRATES IN IMMUNOCOMPROMISED PATIENTS**

INFILTRATE	CAUSE OF PNEUMONIA	
	INFECTIOUS	NONINFECTIOUS
Localized	Bacteria, <i>Legionella</i> , mycobacteria	Local hemorrhage or embolism, tumor
Nodular	Fungi (e.g., <i>Aspergillus</i> or <i>Mucor</i> ), <i>Nocardia</i>	Recurrent tumor
Diffuse	Viruses (especially CMV), <i>Chlamydophila</i> , <i>Pneumocystis</i> , <i>Toxoplasma gondii</i> , mycobacteria	Congestive heart failure, radiation pneumonitis, drug-induced lung injury, diffuse alveolar hemorrhage (described after BMT)

**Note:** BMT, bone marrow transplantation; CMV, cytomegalovirus.

382 nasal passages or on the hard palate should prompt a search for invasive *Aspergillus*. This situation is likely to require surgical debridement. Catheter infections with *Aspergillus* usually require both removal of the catheter and antifungal therapy.

Diffuse interstitial infiltrates suggest viral, parasitic, or *Pneumocystis* pneumonia. If the patient has a diffuse interstitial pattern on chest x-ray, it may be reasonable to institute empirical treatment with TMP-SMX (for *Pneumocystis*) and a quinolone (for *Chlamydia*, *Mycoplasma*, and *Legionella*) or an erythromycin derivative (e.g., azithromycin) while considering invasive diagnostic procedures. Noninvasive procedures, such as staining of sputum smears for *Pneumocystis*, serum cryptococcal antigen tests, and urine testing for *Legionella* antigen, may be helpful. In transplant recipients who are seropositive for cytomegalovirus (CMV), a determination of CMV load in the serum should be considered. Viral load studies (which allow physicians to quantitate viruses) have superseded simple measurement of serum IgG, which merely documents prior exposure to virus. Infections with viruses that cause only upper respiratory symptoms in immunocompetent hosts, such as respiratory syncytial virus (RSV), influenza viruses, and parainfluenza viruses, may be associated with fatal pneumonitis in immunocompromised hosts. An attempt at early diagnosis by nasopharyngeal aspiration should be considered so that appropriate treatment can be instituted.

Bleomycin is the most common cause of chemotherapy-induced lung disease. Other causes include alkylating agents (such as cyclophosphamide, chlorambucil, and melphalan), nitrosoureas [carmustine (BCNU), lomustine (CCNU), and methyl-CCNU], busulfan, procarbazine, methotrexate, and hydroxyurea. Both infectious and non-infectious (drug- and/or radiation-induced) pneumonitis can cause fever and abnormalities on chest x-ray; thus the differential diagnosis of an infiltrate in a patient receiving chemotherapy encompasses a broad range of conditions (Table 28-7). Because the treatment of radiation pneumonitis (which may respond dramatically to glucocorticoids) or drug-induced pneumonitis is different from that of infectious pneumonia, a biopsy may be important in the diagnosis. Unfortunately, no definitive diagnosis can be made in ~30% of cases, even after bronchoscopy.

Open-lung biopsy is the “gold standard” of diagnostic techniques. Biopsy via a visualized thoracostomy can replace an open procedure in many cases. When a biopsy cannot be performed, empirical treatment can be undertaken with a quinolone or erythromycin (or an erythromycin derivative such as azithromycin) and TMP-SMX (in the case of diffuse infiltrates) or with amphotericin B or other antifungal agents (in the case of nodular infiltrates). The risks should be weighed carefully in these cases. If inappropriate drugs are administered, empirical treatment may prove toxic or ineffective; either of these outcomes may be riskier than biopsy.

## CARDIOVASCULAR INFECTIONS

Patients with Hodgkin's disease are prone to persistent infections by *Salmonella*, sometimes (and particularly often in elderly patients) affecting a vascular site. The use of IV catheters deliberately lodged in the right atrium is associated with a high incidence of bacterial endocarditis, presumably related to valve damage followed by bacteremia. Nonbacterial thrombotic endocarditis has been described in association with a variety of malignancies (most often solid tumors) and may follow bone marrow transplantation as well. The presentation of an embolic event with a new cardiac murmur suggests this diagnosis. Blood cultures are negative in this disease of unknown pathogenesis.

## ENDOCRINE SYNDROMES

Infections of the endocrine system have been described in immunocompromised patients. *Candida* infection of the thyroid may be difficult to diagnose during the neutropenic period. It can be defined by indium-labeled WBC scans or gallium scans after neutrophil counts increase. CMV infection can cause adrenalitis with or without resulting adrenal insufficiency. The presentation of a sudden endocrine anomaly in an immunocompromised patient may be a sign of infection in the involved end organ.

## MUSCULOSKELETAL INFECTIONS

Infection that is a consequence of vascular compromise, resulting in gangrene, can occur when a tumor restricts the blood supply to muscles, bones, or joints. The process of diagnosis and treatment of such infection is similar to that in normal hosts, with the following caveats:

1. *In terms of diagnosis*, a lack of physical findings resulting from a lack of granulocytes in the granulocytopenic patient should make the clinician more aggressive in obtaining tissue rather than relying on physical signs.
2. *In terms of therapy*, aggressive debridement of infected tissues may be required, but it is usually difficult to operate on patients who have recently received chemotherapy, both because of a lack of platelets (which results in bleeding complications) and because of a lack of WBCs (which may lead to secondary infection). A blood culture positive for *Clostridium perfringens*—an organism commonly associated with gas gangrene—can have a number of meanings. Bloodstream infections with intestinal organisms such as *Streptococcus bovis* and *C. perfringens* may arise spontaneously from lower gastrointestinal lesions (tumor or polyps); alternatively, these lesions may be harbingers of invasive disease. The clinical setting must be considered in order to define the appropriate treatment for each case.

## RENAL AND URETERAL INFECTIONS

Infections of the urinary tract are common among patients whose ureteral excretion is compromised (Table 28-1). *Candida*, which has a predilection for the kidney, can invade either from the bloodstream or in a retrograde manner (via the ureters or bladder) in immunocompromised patients. The presence of “fungus balls” or persistent candiduria suggests invasive disease. Persistent funguria (with *Aspergillus* as well as *Candida*) should prompt a search for a nidus of infection in the kidney.

Certain viruses are typically seen only in immunosuppressed patients. BK virus (polyomavirus hominis 1) has been documented in the urine of bone marrow transplant recipients and, like adenovirus, may be associated with hemorrhagic cystitis. BK-induced cystitis usually remits with decreasing immunosuppression. Anecdotal reports have described the treatment of infections due to adenovirus and BK virus with cidofovir.

### ABNORMALITIES THAT PREDISPOSE TO INFECTION

(Table 28-1)

## THE LYMPHOID SYSTEM

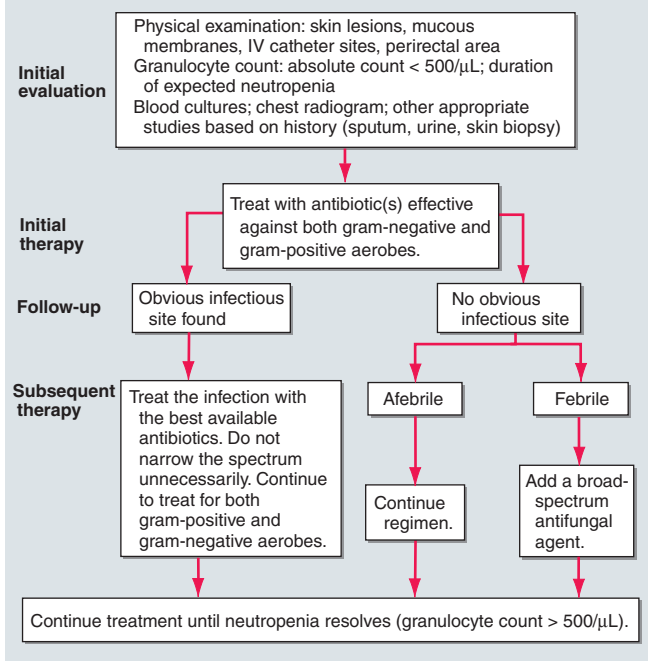
It is beyond the scope of this chapter to detail how all the immunologic abnormalities that result from cancer or from chemotherapy for cancer lead to infections. Disorders of the immune system are discussed in other sections of this book. As noted earlier, patients with antibody deficiency are predisposed to overwhelming infection with encapsulated bacteria (including *S. pneumoniae*, *H. influenzae*, and *N. meningitidis*). It is worth mentioning, however, that patients undergoing intensive chemotherapy for any form of cancer will have not only defects due to granulocytopenia but also lymphocyte dysfunction, which may be profound. Thus these patients—especially those receiving glucocorticoid-containing regimens or drugs that inhibit T cell activation or cytokine induction—should be given prophylaxis for *Pneumocystis pneumonia*.

## THE HEMATOPOIETIC SYSTEM

Initial studies in the 1960s revealed a dramatic increase in the incidence of infections (fatal and nonfatal) among cancer patients with a granulocyte count of  $<500/\mu\text{L}$ . More recent studies have cited a figure of 48.3 infections per 100 neutropenic patients ( $<1000$  granulocytes/ $\mu\text{L}$ ) with hematologic malignancies and solid tumors, or 46.3 infections per 1000 days at risk.

Neutropenic patients are unusually susceptible to infection with a wide variety of bacteria; thus antibiotic therapy should be initiated promptly to cover likely pathogens if infection is suspected. Indeed, early initiation of antibacterial agents is mandatory to prevent

### DIAGNOSIS AND TREATMENT FOR PATIENTS WITH FEBRILE NEUTROPENIA



**FIGURE 28-2**

**Algorithm for the diagnosis and treatment of febrile neutropenic patients.**

deaths. These patients are susceptible to gram-positive and gram-negative organisms found commonly on the skin and in the bowel (Table 28-4). Because treatment with narrow-spectrum agents leads to infection with organisms not covered by the antibiotics used, the initial regimen should target pathogens likely to be initial causes of bacterial infection in neutropenic hosts (Fig. 28-2).

### Rx Treatment: INFECTIONS IN CANCER PATIENTS

**ANTIBACTERIAL THERAPY** Hundreds of antibacterial regimens have been tested for use in patients with cancer. The major risk of infection is related to the degree of neutropenia seen as a consequence of either the disease or the therapy. Many of the relevant studies involved small populations in which the outcomes were generally good, and most lacked the statistical power to detect differences among the regimens studied. Each febrile neutropenic patient should be approached as a unique problem, with particular attention given to previous infections and recent antibiotic exposures. Several general guidelines are useful in the initial treatment of neutropenic patients with fever (Fig. 28-2):

1. In the initial regimen, it is necessary to use antibiotics active against both gram-negative and gram-positive bacteria (Table 28-4).
2. An aminoglycoside or an antibiotic without good activity against gram-positive organisms (e.g., ciprofloxacin or aztreonam) alone is not adequate in this setting.



3. The agents used should reflect both the epidemiology and the antibiotic resistance pattern of the hospital.
4. If the pattern of resistance justifies its use, a single third-generation cephalosporin constitutes an appropriate initial regimen in many hospitals.
5. Most standard regimens are designed for patients who have not previously received prophylactic antibiotics. The development of fever in a patient who has received antibiotics affects the choice of subsequent therapy, which should target resistant organisms and organisms known to cause infections in patients being treated with the antibiotics already administered.
6. Randomized trials have indicated the safety of oral antibiotic regimens in the treatment of "low-risk" patients with fever and neutropenia. Outpatients who are expected to remain neutropenic for <10 days and who have no concurrent medical problems (such as hypotension, pulmonary compromise, or abdominal pain) can be classified as low risk and treated with a broad-spectrum oral regimen.
7. Several large-scale studies indicate that prophylaxis with a fluoroquinolone (ciprofloxacin or levofloxacin) decreases morbidity and mortality rates among afebrile patients who are anticipated to have neutropenia of long duration.

The initial antibacterial regimen should be refined on the basis of culture results (Fig. 28-2). Blood cultures are the most relevant on which to base therapy; surface cultures of skin and mucous membranes may be misleading. In the case of gram-positive bacteremia or another gram-positive infection, it is important that the antibiotic be optimal for the organism isolated. Although it is not desirable to leave the patient unprotected, the addition of more and more antibacterial agents to the regimen is not appropriate unless there is a clinical or microbiologic reason to do so. Planned progressive therapy (the serial, empirical addition of one drug after another without culture data) is not efficacious in most settings and may have unfortunate consequences. Simply adding another antibiotic for fear that a gram-negative infection is present is a dubious practice. The synergy exhibited by  $\beta$ -lactams and aminoglycosides against certain gram-negative organisms (especially *P. aeruginosa*) provides the rationale for using two antibiotics in this setting, but recent analyses suggest that efficacy is not enhanced by the addition of aminoglycosides while toxicity may be increased. Mere "double coverage," with the addition of a quinolone or another antibiotic that is not likely to exhibit synergy, has not been shown to be of benefit and may cause additional toxicities and side effects. Cephalosporins can cause bone marrow suppression, and vancomycin is associated with neutropenia in some healthy individuals. Furthermore, the addition of multiple cephalosporins may induce  $\beta$ -lactamase

production by some organisms; cephalosporins and double  $\beta$ -lactam combinations should probably be avoided altogether in *Enterobacter* infections.

**ANTIFUNGAL THERAPY** Fungal infections in cancer patients are most often associated with neutropenia. Neutropenic patients are predisposed to the development of invasive fungal infections, most commonly those due to *Candida* and *Aspergillus* species and occasionally those caused by *Fusarium*, *Trichosporon*, and *Bipolaris*. Cryptococcal infection, which is common among patients taking immunosuppressive agents, is uncommon among neutropenic patients receiving chemotherapy for AML. Invasive candidal disease is usually caused by *C. albicans* or *C. tropicalis* but can be caused by *C. krusei*, *C. parapsilosis*, and *C. glabrata*.

For decades it has been common clinical practice to add amphotericin B to antibacterial regimens if a neutropenic patient remains febrile despite 4–7 days of treatment with antibacterial agents. The rationale for the empirical addition of amphotericin B is that it is difficult to culture fungi before they cause disseminated disease and that mortality rates from disseminated fungal infections in granulocytopenic patients are high. Before the introduction of newer azoles into clinical practice, amphotericin B was the mainstay of antifungal therapy. The insolubility of amphotericin B has resulted in the marketing of several lipid formulations that are less toxic than the amphotericin B deoxycholate complex. However, because of the high cost of the lipid preparations, their use at many centers is reserved for patients who fail to respond to standard amphotericin B. Because the side effects of the formulations differ, unnecessary switching from one to another is not recommended.

Although fluconazole is efficacious in the treatment of infections due to many *Candida* spp., its use against serious fungal infections in immunocompromised patients is limited by its narrow spectrum: it has no activity against *Aspergillus* or against several non-*albicans* *Candida* spp. The release of newer broad-spectrum azoles (such as voriconazole and posaconazole) has provided another option for the treatment of *Aspergillus* infection (including CNS infection, in which amphotericin B has usually failed). In fact, experience indicates that these drugs may well supplant amphotericin B as the mainstay of treatment because of their lesser toxicity and better penetration into cerebrospinal fluid and other sites. Clinicians should be aware that the spectrum of each azole is somewhat different and that no drug can be assumed to be efficacious against all fungi. For example, whereas voriconazole is active against *Pseudallescheria boydii*, amphotericin B is not; however, voriconazole has no activity against *Mucor*. Recent studies suggest a role for posaconazole as a prophylactic agent in patients with prolonged neutropenia.

Echinocandins (such as caspofungin) are useful in the treatment of infections caused by azole-resistant *Candida*. Studies in progress are assessing the use of these agents in combinations to determine whether treatment with multiple antifungal agents leads to better outcomes.

**ANTIVIRAL THERAPY** The availability of a variety of agents active against herpes-group viruses, including some new agents with a broader spectrum of activity, has heightened focus on the treatment of viral infections, which pose a major problem in cancer patients. Viral diseases caused by the herpes group are prominent. Serious (and sometimes fatal) infections due to HSV and CMV are well documented, and VZV infections may be fatal to patients receiving chemotherapy. The roles of human herpesvirus (HHV) 6, HHV-7, and HHV-8 (Kaposi's sarcoma herpesvirus) in cancer patients are being defined. Although clinical experience is most extensive with acyclovir, which can be used therapeutically or prophylactically, a number of derivative drugs offer advantages over this agent (Table 28-8).

In addition to the herpes group, several respiratory viruses (especially RSV) may cause serious disease in cancer patients. Vaccination with influenza vaccine is recommended (see later), but it may be ineffective in this patient population. The availability of antiviral drugs

with activity against influenza viruses gives the clinician additional options for the treatment of these patients (Table 28-9).

**OTHER THERAPEUTIC MODALITIES** Another way to address the problems of the febrile neutropenic patient is to replenish the neutrophil population. Although granulocyte transfusions are efficacious in the treatment of refractory gram-negative bacteremia, they do not have a documented role in prophylaxis. Because of the expense, the risk of leukoagglutinin reactions (which has probably been decreased by improved cell-separation procedures), and the risk of transmission of CMV from unscreened donors (which has been reduced by the use of filters), granulocyte transfusion is reserved for patients unresponsive to antibiotics. This modality is efficacious for documented gram-negative bacteremia refractory to antibiotics, particularly in situations where granulocyte numbers will be depressed for only a short period. The demonstrated usefulness of granulocyte colony-stimulating factor (G-CSF) in mobilizing neutrophils and advances in preservation techniques may make this option more useful than in the past.

A variety of cytokines, including G-CSF and granulocyte-macrophage colony-stimulating factor, enhance granulocyte recovery after chemotherapy and consequently shorten the period of maximal vulnerability to fatal

TABLE 28-8

## ANTIVIRAL AGENTS ACTIVE AGAINST HERPESVIRUSES

AGENT	DESCRIPTION	SPECTRUM	TOXICITY	OTHER ISSUES
Acyclovir	Inhibits HSV polymerase	HSV, VZV (± CMV, EBV)	Rarely has side effects; crystalluria can occur at high doses	Long history of safety; original antiviral agent
Famciclovir	Prodrug of penciclovir (a guanosine analogue)	HSV, VZV (± CMV)	Associated with cancer in rats	Longer effective half-life than acyclovir
Valacyclovir	Prodrug of acyclovir; better absorption	HSV, VZV (± CMV)	Associated with thrombotic microangiopathy in one study of immunocompromised patients	Better oral absorption and longer effective half-life than acyclovir; can be given as a single daily dose for prophylaxis
Ganciclovir	More potent polymerase inhibitor; more toxic than acyclovir	HSV, VZV, CMV, HHV-6	Bone marrow suppression	Neutropenia may respond to G-CSF or GM-CSF
Valganciclovir	Prodrug of ganciclovir; better absorption	HSV, VZV, CMV, HHV-6	Bone marrow suppression	—
Cidofovir	Nucleotide analogue of cytosine	HSV, VZV, CMV; good in vitro activity against adenovirus and others	Nephrotoxic marrow suppression	Given IV once a week
Foscarnet	Phosphonoformic acid; inhibits viral DNA polymerase	HSV, VZV, CMV, HHV-6	Nephrotoxic; electrolyte abnormalities common	IV only

**Note:** ±, agent has some activity but not enough for the treatment of infections; CMV, cytomegalovirus; EBV, Epstein-Barr virus; G-CSF, granulocyte colony-stimulating factor; GM-CSF, granulocyte-macrophage colony-stimulating factor; HHV, human herpesvirus; HSV, herpes simplex virus; VZV, varicella-zoster virus.

## OTHER ANTIVIRAL AGENTS USEFUL IN THE TREATMENT OF INFECTIONS IN CANCER PATIENTS

AGENT	DESCRIPTION	SPECTRUM	TOXICITY	OTHER ISSUES
Amantadine, rimantadine	Interfere with uncoating	Influenza A only	5–10% fewer CNS effects with rimantadine	May be given prophylactically
Zanamivir	Neuraminidase inhibitor	Influenza A and B	Usually well tolerated	Inhalation only
Oseltamivir	Neuraminidase inhibitor	Influenza A and B	Usually well tolerated	PO dosing
Pleconaril	Blocks enterovirus binding and uncoating	90% of enteroviruses, 80% of rhinoviruses	Generally well tolerated	Decreases duration of meningitis; available for compassionate use only
Interferons	Cytokines with broad spectrum of activity	Used locally for warts, systemically for hepatitis	Fever, myalgias, bone marrow suppression	Not shown to be helpful in CMV infection; use limited by toxicity
Ribavirin	Purine analogue (precise mechanism of action unknown)	Broad theoretical spectrum; documented use against RSV, Lassa fever virus, and hepatitis viruses (with interferon)	IV form causes anemia	Given by aerosol for RSV infection (efficacy in doubt); approved for use in children with heart/lung disease

**Note:** CMV, cytomegalovirus; CNS, central nervous system; RSV, respiratory syncytial virus.

infections. The role of these cytokines in routine practice is still a matter of some debate. Most authorities recommend their use only when neutropenia is both severe and prolonged. The cytokines themselves may have adverse effects, including fever, hypoxemia, and pleural effusions or serositis in other areas. Because little evidence indicates that their routine administration lessens the risk of death and they are still expensive, the use of these cytokines has not become the standard of care in all centers. The role of other cytokines (such as macrophage colony-stimulating factor for monocytes or interferon- $\gamma$ ) in preventing or treating infections in granulocytopenic patients is under investigation.

Once neutropenia has resolved, patients are not at increased risk of infection. However, depending on what drugs they receive, patients who continue on chemotherapeutic protocols remain at high risk for certain diseases. Any patient receiving more than a maintenance dose of glucocorticoids (including many treatment regimens for diffuse lymphoma) should also receive prophylactic TMP-SMX because of the risk of *Pneumocystis* infection; those with ALL should receive such prophylaxis for the duration of chemotherapy.

## PREVENTION OF INFECTION IN CANCER PATIENTS

### EFFECT OF THE ENVIRONMENT

Outbreaks of fatal *Aspergillus* infection have been associated with construction projects and materials in several hospitals. The association between spore counts and risk

of infection suggests the need for a high-efficiency air-handling system in hospitals that care for large numbers of neutropenic patients. The use of laminar-flow rooms and prophylactic antibiotics has decreased the number of infectious episodes in severely neutropenic patients. However, because of the expense of such a program and the failure to show that it dramatically affects mortality rates, most centers do not routinely use laminar flow to care for neutropenic patients. Some centers use “reverse isolation,” in which health care providers and visitors to a patient who is neutropenic wear gowns and gloves. Because most of the infections these patients develop are due to organisms that colonize the patients’ own skin and bowel, the validity of such schemes is dubious, and limited clinical data do not support their use. Hand washing by all staff caring for neutropenic patients should be required to prevent the spread of resistant organisms.

The presence of large numbers of bacteria (particularly *P. aeruginosa*) in certain foods, especially fresh vegetables, has led some authorities to recommend a special “low-bacteria” diet. A diet consisting of cooked and canned food is satisfactory to most neutropenic patients and does not involve elaborate disinfection or sterilization protocols. However, there are no studies to support even this type of dietary restriction. Counseling of patients to avoid leftovers, deli foods, and unpasteurized dairy products is recommended.

### PHYSICAL MEASURES

Although few studies address this issue, patients with cancer are predisposed to infections resulting from anatomic compromise (e.g., lymphedema resulting from node dissections after radical mastectomy). Surgeons

who specialize in cancer surgery can provide specific guidelines for the care of such patients, and patients benefit from commonsense advice about how to prevent infections in vulnerable areas.

## IMMUNOGLOBULIN REPLACEMENT

Many patients with multiple myeloma or CLL have immunoglobulin deficiencies as a result of their disease, and all allogeneic bone marrow transplant recipients are hypogammaglobulinemic for a period after transplantation. However, current recommendations reserve intravenous immunoglobulin (IVIg) replacement therapy for those patients with severe (<400 mg/dL), prolonged hypogammaglobulinemia. Antibiotic prophylaxis has been shown to be cheaper and efficacious in preventing infections in most CLL patients with hypogammaglobulinemia. Routine use of IVIg replacement is not recommended.

## SEXUAL PRACTICES

The use of condoms is recommended for severely immunocompromised patients. Any sexual practice that results in oral exposure to feces is not recommended. Neutropenic patients should be advised to avoid any practice that results in trauma because even microscopic cuts may result in bacterial invasion and fatal sepsis.

## ANTIBIOTIC PROPHYLAXIS

Several studies indicate that the use of oral fluoroquinolones prevents infection and decreases mortality rates among severely neutropenic patients. Fluconazole prevents *Candida* infections when given prophylactically to patients receiving bone marrow transplants. The use of broader-spectrum antifungal agents (e.g., posaconazole) appears to be more efficacious. Prophylaxis for *Pneumocystis* is mandatory for patients with ALL and for all cancer patients receiving glucocorticoid-containing chemotherapy regimens.

## VACCINATION OF CANCER PATIENTS

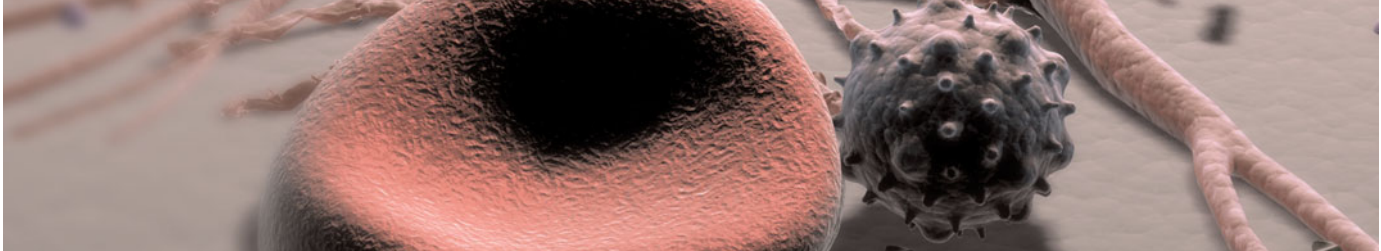
In general, patients undergoing chemotherapy respond less well to vaccines than do normal hosts. Their greater

need for vaccines thus leads to a dilemma in their management. Purified proteins and inactivated vaccines are almost never contraindicated and should be given to patients even during chemotherapy. For example, all adults should receive diphtheria-tetanus toxoid boosters at the indicated times as well as seasonal influenza vaccine. However, if possible, vaccination should not be undertaken concurrent with cytotoxic chemotherapy. If patients are expected to be receiving chemotherapy for several months and vaccination is indicated (e.g., influenza vaccination in the fall), the vaccine should be given midcycle—as far apart in time as possible from the antimetabolic agents that will prevent an immune response. The meningococcal and pneumococcal polysaccharide vaccines should be given to patients before splenectomy, if possible. The *H. influenzae* type b conjugate vaccine should be administered to all splenectomized patients.

In general, live virus (or live bacterial) vaccines should not be given to patients during intensive chemotherapy because of the risk of disseminated infection. Recommendations on vaccination are summarized in Table 28-2.

## FURTHER READINGS

- BOHLIUS J et al: Granulopoiesis-stimulating factors to prevent adverse effects in the treatment of malignant lymphoma. *Cochrane Database Syst Rev* CD003189, 2004
- GAFTER-GVILI A et al: Antibiotic prophylaxis for bacterial infections in afebrile neutropenic patients following chemotherapy. *Cochrane Database Syst Rev* CD004386, 2005
- HALL K et al: Diagnosis and management of long-term central venous catheter infections. *J Vasc Interv Radiol* 15:327, 2004
- KAMBOJ M, SEPKOWITZ KA: Nosocomial infections in patients with cancer. *Lancet Oncol* 10:589, 2009
- KLASTERSKY J: The changing face of febrile neutropenia—from monotherapy to moulds to mucositis. Why empirical therapy? *J Antimicrob Chemother* 63 (suppl 1):i14, 2009
- PAUL M et al: Empirical antibiotic monotherapy for febrile neutropenia: Systematic review and meta-analysis of randomized controlled trials. *J Antimicrob Chemother* 57:176, 2006
- SEGAL BH: Aspergillosis. *N Engl J Med* 360:1870, 2009
- SPENCER SP et al: Multidetector computed tomography of the acute abdomen in the immunocompromised host: A pictorial review. *Curr Probl Diagn Radiol* 38:145, 2009
- ÜLLMANN AJ et al: Posaconazole or fluconazole for prophylaxis in severe graft-versus-host disease. *N Engl J Med* 356:335, 2007



## CHAPTER 29

# HEMATOPOIETIC CELL TRANSPLANTATION

Frederick R. Appelbaum

■ The Hematopoietic Stem Cell	.388
■ Categories of Hematopoietic Cell Transplantation	.388
■ The Transplant Preparative Regimen	.390
The Transplant Procedure	.390
Engraftment	.391
Complications Following Hematopoietic Cell Transplant	.391
■ Treatment of Specific Diseases using Hematopoietic Cell Transplantation	.394
■ Further Readings	.397

*Bone marrow transplantation* was the original term used to describe the collection and transplantation of hematopoietic stem cells, but with the demonstration that the peripheral blood and umbilical cord blood are also useful sources of stem cells, *hematopoietic cell transplantation* has become the preferred generic term for this process. The procedure is usually carried out for one of two purposes: (1) to replace an abnormal but nonmalignant lymphohematopoietic system with one from a normal donor, or (2) to treat malignancy by allowing the administration of higher doses of myelosuppressive therapy than would otherwise be possible. The use of hematopoietic cell transplantation has been increasing, both because of its efficacy in selected diseases and because of increasing availability of donors. The International Bone Marrow Transplant Registry (<http://www.ibmtr.org>) estimates that ~50,000 transplants are performed each year.

### THE HEMATOPOIETIC STEM CELL

Several features of the hematopoietic stem cell make transplantation clinically feasible, including its remarkable regenerative capacity, its ability to home to the marrow space following intravenous injection, and the ability of the stem cell to be cryopreserved. Transplantation of a single stem cell can replace the entire lymphohematopoietic system of an adult mouse. In humans, transplantation of a few percent of a donor's bone

marrow volume regularly results in complete and sustained replacement of the recipient's entire lymphohematopoietic system, including all red cells, granulocytes, B and T lymphocytes, and platelets, as well as cells comprising the fixed macrophage population, including Kupffer cells of the liver, pulmonary alveolar macrophages, osteoclasts, Langerhans cells of the skin, and brain microglial cells. The ability of the hematopoietic stem cell to home to the marrow following intravenous injection is mediated, at least in part, by the interaction of cell-surface molecules, termed *selectins*, on bone marrow endothelial cells with ligands, termed *integrins*, on early hematopoietic cells. Human hematopoietic stem cells can survive freezing and thawing with little, if any, damage, making it possible to remove and store a portion of the patient's own bone marrow for later reinfusion following treatment of the patient with high-dose myelo-toxic therapy.

### CATEGORIES OF HEMATOPOIETIC CELL TRANSPLANTATION

Hematopoietic cell transplantation can be described according to the relationship between the patient and the donor and by the anatomic source of stem cells. In ~1% of cases, patients have identical twins who can serve as donors. With the use of syngeneic donors, there is no risk of graft-versus-host disease (GVHD) that

often complicates allogeneic transplantation, and unlike the use of autologous marrow, there is no risk that the stem cells are contaminated with tumor cells.

*Allogeneic transplantation* involves a donor and recipient who are not immunologically identical. Following allogeneic transplantation, immune cells transplanted with the stem cells or developing from them can react against the patient, causing GVHD. Alternatively, if the immunosuppressive preparative regimen used to treat the patient before transplant is inadequate, immunocompetent cells of the patient can cause graft rejection. The risks of these complications are greatly influenced by the degree of matching between donor and recipient for antigens encoded by genes of the major histocompatibility complex.

The human leukocyte antigen (HLA) molecules are responsible for binding antigenic proteins and presenting them to T cells. The antigens presented by HLA molecules may derive from exogenous sources (e.g., during active infections) or may be endogenous proteins. If individuals are not HLA-matched, T cells from one individual will react strongly to the mismatched HLA, or “major antigens,” of the second. Even if the individuals are HLA-matched, the T cells of the donor may react to differing endogenous, or “minor antigens,” presented by the HLA of the recipient. Reactions to minor antigens tend to be less vigorous. The genes of major relevance to transplantation include HLA-A, -B, -C, and -D; they are closely linked and therefore tend to be inherited as haplotypes, with only rare crossovers between them. Thus the odds that any one full sibling will match a patient are one in four, and the probability that the patient has an HLA-identical sibling is  $1 - (0.75)^n$ , where  $n$  equals the number of siblings.

With current techniques, the risk of graft rejection is 1–3%, and the risk of severe, life-threatening acute GVHD is ~15% following transplantation between HLA-identical siblings. The incidence of graft rejection and GVHD increases progressively with the use of family member donors mismatched for one, two, or three antigens. Although survival following a one-antigen mismatched transplant is not markedly altered, survival following two- or three-antigen mismatched transplants is significantly reduced, and such transplants should be performed only as part of clinical trials.

Since the formation of the National Marrow Donor Program, it has become possible to identify HLA-matched unrelated donors for many patients. The genes encoding HLA antigens are highly polymorphic, and thus the odds of any two unrelated individuals being HLA-identical are extremely low, somewhat less than 1 in 10,000. However, by identifying and typing >7 million volunteer donors, HLA-matched donors can now be found for ~50% of patients for whom a search is initiated. It takes, on average, 3–4 months to complete a search and schedule and initiate an unrelated donor

transplant. Results so far suggest that GVHD is somewhat increased and survival somewhat poorer with such donors than with HLA-matched siblings.

*Autologous transplantation* involves the removal and storage of the patient’s own stem cells with subsequent reinfusion after the patient receives high-dose myeloablative therapy. Unlike allogeneic transplantation, there is no risk of GVHD or graft rejection with autologous transplantation. However, autologous transplantation lacks a graft-versus-tumor (GVT) effect, and the autologous stem cell product can be contaminated with tumor cells that could lead to relapse. A variety of techniques have been developed to “purge” autologous products of tumor cells. Some use antibodies directed at tumor-associated antigens plus complement, antibodies linked to toxins, or antibodies conjugated to immunomagnetic beads. In vitro incubation with certain chemotherapeutic agents such as 4-hydroperoxycyclophosphamide and long-term culture of bone marrow have also been shown to diminish tumor cell numbers in stem cell products. Another technique is positive selection of stem cells using antibodies to CD34, with subsequent column adherence or flow techniques to select normal stem cells while leaving tumor cells behind. All these approaches can reduce the number of tumor cells from 1000- to 10,000-fold and are clinically feasible; however, no prospective randomized trials have yet shown that any of these approaches results in a decrease in relapse rates or improvements in disease-free or overall survival.

Bone marrow aspirated from the posterior and anterior iliac crests has traditionally been the source of hematopoietic stem cells for transplantation. Typically, anywhere from  $1.5$  to  $5 \times 10^8$  nucleated marrow cells per kilogram are collected for allogeneic transplantation. Several studies have found improved survival in the settings of both matched sibling and unrelated transplantation by transplanting higher numbers of bone marrow cells.

Hematopoietic stem cells circulate in the peripheral blood but in very low concentrations. Following the administration of certain hematopoietic growth factors, including granulocyte colony-stimulating factor (G-CSF) or granulocyte-macrophage colony-stimulating factor (GM-CSF), and during recovery from intensive chemotherapy, the concentration of hematopoietic progenitor cells in blood, as measured either by colony-forming units or expression of the CD34 antigen, increases markedly. This has made it possible to harvest adequate numbers of stem cells from the peripheral blood for transplantation. Donors are typically treated with 4 or 5 days of hematopoietic growth factor, following which stem cells are collected in one or two 4-h pheresis sessions. In the autologous setting, transplantation of  $>2.5 \times 10^6$  CD34 cells per kilogram, a number easily collected in most circumstances, leads to rapid and sustained engraftment in virtually all cases. Compared to the use of autologous marrow, use of peripheral blood

390 stem cells results in more rapid hematopoietic recovery, with granulocytes recovering to 500/ $\mu$ L by day 12 and platelets recovering to 20,000/ $\mu$ L by day 14. Although this more rapid recovery diminishes the morbidity of transplantation, no studies show improved survival.

Hesitation in studying the use of peripheral blood stem cells for allogeneic transplantation was because peripheral blood stem cell products contain as much as one log more T cells than are contained in the typical marrow harvest; in animal models, the incidence of GVHD is related to the number of T cells transplanted. Nonetheless, clinical trials have shown that the use of growth factor–mobilized peripheral blood stem cells from HLA-matched family members leads to faster engraftment without an increase in acute GVHD. Chronic GVHD may be increased with peripheral blood stem cells, but in trials conducted so far, this has been more than balanced by reductions in relapse rates and nonrelapse mortality, with the use of peripheral blood stem cells resulting in improved overall survival.

Umbilical cord blood contains a high concentration of hematopoietic progenitor cells, allowing for its use as a source of stem cells for transplantation. Cord blood transplantation from family members has been explored in the setting where the immediate need for transplantation precludes waiting the ~9 months generally required for the baby to mature to the point of donating marrow. Use of cord blood results in slower engraftment and peripheral count recovery than seen with marrow but a low incidence of GVHD, perhaps reflecting the low number of T cells in cord blood. Several banks have been developed to harvest and store cord blood for possible transplantation to unrelated patients from material that would otherwise be discarded. A summary of the first 562 unrelated cord blood transplants, facilitated by the New York Blood Center, reported engraftment in ~85% of patients but at a slower pace than seen with marrow. Severe GVHD was seen in 23% of patients. The risk of graft failure was related to the dose of cord blood cells per kilogram infused. The low cell content of most cord blood collections has limited the use of this approach for adult patients.

## THE TRANSPLANT PREPARATIVE REGIMEN

The treatment regimen administered to patients immediately preceding transplantation is designed to eradicate the patient's underlying disease and, in the setting of allogeneic transplantation, immunosuppress the patient adequately to prevent rejection of the transplanted marrow. The appropriate regimen therefore depends on the disease setting and source of marrow. For example, when transplantation is performed to treat severe combined immunodeficiency and the donor is a histocompatible

sibling, no treatment is required because no host cells require eradication and the patient is already too immunoincompetent to reject the transplanted marrow. For aplastic anemia, there is no large population of cells to eradicate, and high-dose cyclophosphamide plus antithymocyte globulin are sufficient to immunosuppress the patient adequately to accept the marrow graft. In the setting of thalassemia and sickle cell anemia, high-dose busulfan is frequently added to cyclophosphamide in order to eradicate hyperplastic host hematopoiesis. A variety of different regimens have been developed to treat malignant diseases. Most of these regimens include agents that have high activity against the tumor in question at conventional doses and have myelosuppression as their predominant dose-limiting toxicity. Therefore, these regimens commonly include busulfan, cyclophosphamide, melphalan, thiotepea, carmustine, etoposide, and total-body irradiation in various combinations.

Although high-dose treatment regimens have typically been used in transplantation, the understanding that much of the antitumor effect of transplantation derives from an immunologically mediated GVT response has led investigators to ask if less-intensive “nonmyeloablative” regimens might be effective and more tolerable. Evidence for a GVT effect comes from studies showing that posttransplant relapse rates are lowest in patients who develop acute and chronic GVHD, higher in those without GVHD, and higher still in recipients of T cell–depleted allogeneic or syngeneic marrow. The demonstration that complete remissions can be obtained in many patients who have relapsed posttransplant by simply administering viable lymphocytes from the original donor further strengthens the argument for a potent GVT effect. Accordingly, a variety of less-intensive nonmyeloablative regimens have been studied, ranging in intensity from the very minimum required to achieve engraftment (e.g., fludarabine plus 200 cGy total-body irradiation) to regimens of more immediate intensity (e.g., fludarabine plus melphalan). Studies to date document that engraftment can be readily achieved with less toxicity than seen with conventional transplantation. Furthermore, the severity of GVHD appears to be decreased because less tissue damage is done by the lower doses of drugs in the preparative regimen. Complete sustained responses have been documented in many patients, particularly those with more indolent hematologic malignancies. The role of nonmyeloablative transplants in any disease, however, has not been fully defined.

## THE TRANSPLANT PROCEDURE

Marrow is usually collected from the donor's posterior and sometimes anterior iliac crests with the donor under general or spinal anesthesia. Typically, 10–15 mL/kg of marrow is aspirated, placed in heparinized media, and

filtered through 0.3- and 0.2-mm screens to remove fat and bony spicules. The collected marrow may undergo further processing depending on the clinical situation, such as the removal of red cells to prevent hemolysis in ABO-incompatible transplants, the removal of donor T cells to prevent GVHD, or attempts to remove possible contaminating tumor cells in autologous transplantation. Marrow donation is safe, with only very rare complications reported.

Peripheral blood stem cells are collected by leukapheresis after the donor has been treated with hematopoietic growth factors or, in the setting of autologous transplantation, sometimes after treatment with a combination of chemotherapy and growth factors. Stem cells for transplantation are generally infused through a large-bore central venous catheter. Such infusions are usually well tolerated, although occasionally patients develop fever, cough, or shortness of breath. These symptoms usually resolve with slowing of the infusion. When the stem cell product has been cryopreserved using dimethyl sulfoxide, patients more often experience short-lived nausea or vomiting due to the odor and taste of the cryoprotectant.

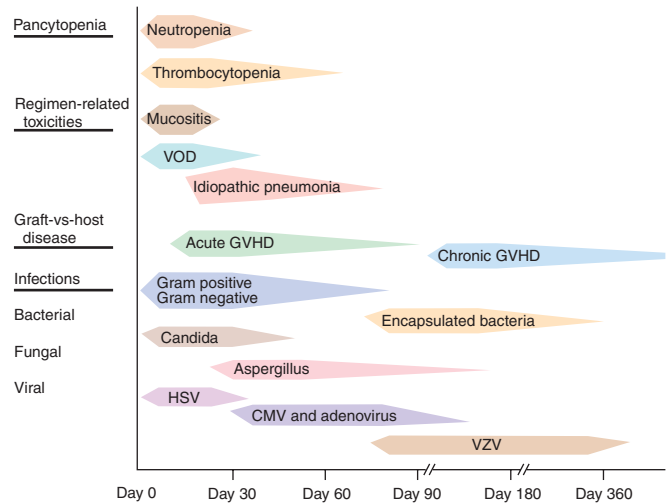
## ENGRAFTMENT

Peripheral blood counts usually reach their nadir several days to a week posttransplant as a consequence of the preparative regimen, and then cells produced by the transplanted stem cells begin to appear in the peripheral blood. The rate of recovery depends on the source of stem cells, the use of posttransplant growth factors, and the form of GVHD prophylaxis employed. If marrow is the source of stem cells, recovery to 100 granulocytes/ $\mu\text{L}$  occurs by day 16 and to 500/ $\mu\text{L}$  by day 22. Use of G-CSF–mobilized peripheral blood stem cells speeds the rate of recovery by  $\sim 1$  week when compared to marrow. Use of a myeloid growth factor (G-CSF or GM-CSF) posttransplant can further accelerate recovery by 3–5 days; use of methotrexate to prevent GVHD delays engraftment by a similar period. Following allogeneic transplantation, engraftment can be documented using fluorescence in situ hybridization of sex chromosomes if donor and recipient are sex-mismatched, HLA-typing if HLA-mismatched, or restriction fragment length polymorphism analysis if sex- and HLA-matched.

## COMPLICATIONS FOLLOWING HEMATOPOIETIC CELL TRANSPLANT

### Early Direct Chemoradiotoxicities

The transplant preparative regimens commonly used cause a spectrum of acute toxicities that vary according to the specific regimen but frequently result in nausea, vomiting, and mild skin erythema (Fig. 29-1). Regimens that include high-dose cyclophosphamide can result in



**FIGURE 29-1**

**Major syndromes complicating marrow transplantation.** VOD, venoocclusive disease; GVHD, graft-versus-host disease; HSV, herpes simplex virus; CMV, cytomegalovirus; VZV, varicella-zoster virus. The size of the shaded area roughly reflects the risk of the complication.

hemorrhagic cystitis, which can usually be prevented by bladder irrigation or with the sulfhydryl compound mercaptoethanesulfonate (MESNA); rarely, acute hemorrhagic carditis is seen. Most preparative regimens result in oral mucositis, which typically develops 5–7 days posttransplant and often requires narcotic analgesia. Use of a patient-controlled analgesic pump provides the greatest patient satisfaction and results in a lower cumulative dose of narcotic. Patients begin losing their hair 5–6 days posttransplant and by 1 week are usually profoundly pancytopenic.

Approximately 10% of patients develop venoocclusive disease of the liver, a syndrome resulting from direct cytotoxic injury to hepatic-venular and sinusoidal endothelium, with subsequent deposition of fibrin and the development of a local hypercoagulable state. This chain of events results in the clinical symptoms of tender hepatomegaly, ascites, jaundice, and fluid retention. These symptoms can develop any time during the first month posttransplant, with the peak incidence at day 16. Predisposing factors include prior exposure to intensive chemotherapy, pretransplant hepatitis of any cause, and use of more intense conditioning regimens. The mortality of venoocclusive disease is  $\sim 30\%$ , with progressive hepatic failure culminating in a terminal hepatorenal syndrome. Both thrombolytic and antithrombotic agents, such as tissue plasminogen activator, heparin, and prostaglandin E, have been studied as therapy, but none has proven of consistent major benefit in controlled trials, and all have significant toxicity. Early studies with defibrotide, a polydeoxyribonucleotide, seem encouraging.

Although most pneumonias developing posttransplant are caused by infectious agents, in  $\sim 5\%$  of patients a



392 diffuse interstitial pneumonia will develop that is thought to be the result of direct toxicity of the preparative regimen. Bronchoalveolar lavage typically shows alveolar hemorrhage, and biopsies are typically characterized by diffuse alveolar damage, although some cases may have a more clearly interstitial pattern. High-dose glucocorticoids are often used as treatment, although randomized trials testing their utility have not been reported.

### Late Direct Chemoradiotoxicities

Late complications of the preparative regimen include decreased growth velocity in children and delayed development of secondary sex characteristics. These complications can be partly ameliorated with the use of appropriate growth and sex hormone replacement. Most men become azoospermic, and most postpubertal women will develop ovarian failure, which should be treated. Thyroid dysfunction, usually well compensated, is sometimes seen. Cataracts develop in 10–20% of patients and are most common in patients treated with total-body irradiation and those who receive glucocorticoid therapy posttransplant for treatment of GVHD. Aseptic necrosis of the femoral head is seen in 10% of patients and particularly frequent in those receiving chronic glucocorticoid therapy.

### Graft-Versus-Host Disease

GVHD is the result of allogeneic T cells that were either transferred with the donor's stem cell inoculum or develop from it, reacting with antigenic targets on host cells. GVHD developing within the first 3 months posttransplant is termed *acute GVHD*; GVHD developing or persisting beyond 3 months posttransplant is termed *chronic GVHD*. Acute GVHD most often first becomes apparent 2–4 weeks posttransplant and is characterized by an erythematous maculopapular rash; persistent

anorexia or diarrhea, or both; and by liver disease with increased serum levels of bilirubin, alanine and aspartate aminotransferase, and alkaline phosphatase. Because many conditions can mimic acute GVHD, diagnosis usually requires skin, liver, or endoscopic biopsy for confirmation. In all these organs, endothelial damage and lymphocytic infiltrates are seen. In skin, the epidermis and hair follicles are damaged; in liver, the small bile ducts show segmental disruption; and in intestines, destruction of the crypts and mucosal ulceration may be noted. A commonly used rating system for acute GVHD is shown in **Table 29-1**. Grade I acute GVHD is of little clinical significance, does not affect the likelihood of survival, and does not require treatment. In contrast, grades II to IV GVHD are associated with significant symptoms and a poorer probability of survival, and they require aggressive therapy. The incidence of acute GVHD is higher in recipients of stem cells from mismatched or unrelated donors, in older patients, and in patients unable to receive full doses of drugs used to prevent the disease.

One general approach to the prevention of GVHD is the administration of immunosuppressive drugs early after transplant. Combinations of methotrexate and either cyclosporine or tacrolimus are among the most effective and widely used regimens. Prednisone, anti-T cell antibodies, mycophenolate mofetil, and other immunosuppressive agents have also been or are being studied in various combinations. A second general approach to GVHD prevention is removal of T cells from the stem cell inoculum. Although effective in preventing GVHD, T cell depletion is associated with an increased incidence of graft failure and of tumor recurrence posttransplant; as yet, little evidence suggests that T-cell depletion improves cure rates in any specific setting.

Despite prophylaxis, significant acute GVHD will develop in ~30% of recipients of stem cells from matched siblings and in as many as 60% of those receiving stem cells from unrelated donors. The disease is usually treated

**TABLE 29-1**

**CLINICAL STAGING AND GRADING OF ACUTE GRAFT-VERSUS-HOST DISEASE**

CLINICAL STAGE	SKIN	LIVER—BILIRUBIN, $\mu\text{mol/L}$ (mg/dL)	GUT
1	Rash <25% body surface	34–51 (2–3)	Diarrhea 500–1000 mL/d
2	Rash 25–50% body surface	51–103 (3–6)	Diarrhea 1000–1500 mL/d
3	Generalized erythroderma	103–257 (6–15)	Diarrhea >1500 mL/d
4	Desquamation and bullae	>257 (>15)	Ileus
OVERALL CLINICAL GRADE	SKIN STAGE	LIVER STAGE	GUT STAGE
I	1–2	0	0
II	1–3	1	1
III	1–3	2–3	2–3
IV	2–4	2–4	2–4

with glucocorticoids, antithymocyte globulin, or monoclonal antibodies targeted against T cells or T cell subsets.

Between 20% and 50% of patients surviving >6 months after allogeneic transplantation develop chronic GVHD. The disease is more common in older patients, in recipients of mismatched or unrelated stem cells, and in those with a preceding episode of acute GVHD. The disease resembles an autoimmune disorder with malar rash, sicca syndrome, arthritis, obliterative bronchiolitis, and bile duct degeneration and cholestasis. Single-agent prednisone or cyclosporine is standard treatment at present, although trials of other agents are underway. In most patients, chronic GVHD resolves, but it may require 1–3 years of immunosuppressive treatment before these agents can be withdrawn without the disease recurring. Because patients with chronic GVHD are susceptible to significant infection, they should receive prophylactic trimethoprim-sulfamethoxazole, and all suspected infections should be investigated and treated aggressively.

### Graft Failure

Although complete and sustained engraftment is usually seen posttransplant, occasionally marrow function either does not return or, after a brief period of engraftment, is lost. Graft failure after autologous transplantation can be the result of inadequate numbers of stem cells being transplanted, damage during ex vivo treatment or storage, or exposure of the patient to myelotoxic agents posttransplant. Infections with cytomegalovirus (CMV) or human herpes virus type 6 have also been associated with loss of marrow function. Graft failure after allogeneic transplantation can also be due to immunologic rejection of the graft by immunocompetent host cells. Immunologically based graft rejection is more common following use of less-immunosuppressive preparative regimens, in recipients of T cell–depleted stem cell products, and in patients receiving grafts from HLA-mismatched donors.

Treatment of graft failure usually involves removing all potentially myelotoxic agents from the patient's

regimen and attempting a short trial of a myeloid growth factor. Persistence of lymphocytes of host origin in allogeneic transplant recipients with graft failure indicates immunologic rejection. Reinfusion of donor stem cells in such patients is usually unsuccessful unless preceded by a second immunosuppressive preparative regimen. Standard preparative regimens are generally tolerated poorly if administered within 100 days of a first transplant because of cumulative toxicities. However, use of regimens combining, for example, anti-CD3 antibodies with high-dose glucocorticoids, fludarabine plus low-dose total-body irradiation, or cyclophosphamide plus antithymocyte globulin have been effective in some cases.

### Infection

Posttransplant patients, particularly recipients of allogeneic transplantation, require unique approaches to the problem of infection. Early after transplantation, patients are profoundly neutropenic, and because the risk of bacterial infection is so great, most centers initiate antibiotic treatment once the granulocyte count falls to <500/ $\mu$ L. Fluconazole prophylaxis at a dose of 200–400 mg/kg per day reduces the risk of candidal infections. Patients seropositive for herpes simplex should receive acyclovir prophylaxis. One approach to infection prophylaxis is shown in [Table 29-2](#). Despite these prophylactic measures, most patients develop fever and signs of infection posttransplant. The management of patients who become febrile despite bacterial and fungal prophylaxis is a difficult challenge and is guided by individual aspects of the patient and by the institution's experience.

Once patients engraft, the incidence of bacterial infection diminishes; however, patients, particularly allogeneic transplant recipients, remain at significant risk of infection. During the period from engraftment until ~3 months posttransplant, the most common causes of infection are gram-positive bacteria, fungi (particularly *Aspergillus*), and viruses including CMV. CMV infection, which in the past was frequently seen and often fatal,

**TABLE 29-2**

#### APPROACH TO INFECTION PROPHYLAXIS IN ALLOGENEIC TRANSPLANT RECIPIENTS

ORGANISM		APPROACH
Bacterial	Ceftazidime	2 g IV q8h while neutropenic
Fungal	Fluconazole	400 mg PO qd to day 75 posttransplant
<i>Pneumocystis carinii</i>	Trimethoprim-sulfamethoxazole	1 double-strength tablet PO bid 2 days/week until day 180 or off immunosuppression
Viral		
Herpes simplex	Acyclovir	800 mg PO bid to day 30
Varicella zoster	Acyclovir	800 mg PO bid to day 365
Cytomegalovirus	Ganciclovir	5 mg/kg IV bid for 7 days, then 5 (mg/kg)/d 5 days/week to day 100

394 can be prevented in seronegative patients by the use of seronegative blood products. The use of ganciclovir, either as prophylaxis beginning at the time of engraftment or initiated when CMV first reactivates as evidenced by development of antigenemia, can significantly reduce the risk of CMV disease in seropositive patients. Elimination of white blood cells from transfused blood products is another method to prevent CMV transmission. Foscarnet is effective for some patients who develop CMV antigenemia or infection despite the use of ganciclovir or who cannot tolerate the drug.

*Pneumocystis jiroveci* pneumonia, once seen in 5–10% of patients, can be prevented by treating patients with oral trimethoprim-sulfamethoxazole for 1 week pretransplant and resuming the treatment once patients have engrafted.

The risk of infection diminishes considerably beyond 3 months after transplant unless chronic GVHD develops, requiring continuous immunosuppression. Most transplant centers recommend continuing trimethoprim-sulfamethoxazole prophylaxis while patients are receiving any immunosuppressive drugs and also recommend careful monitoring for late CMV reactivation. In addition, many centers recommend prophylaxis against varicella zoster, using acyclovir for 1 year posttransplant.

## TREATMENT OF SPECIFIC DISEASES USING HEMATOPOIETIC CELL TRANSPLANTATION

### **Rx** Treatment: NONMALIGNANT DISEASES

**IMMUNODEFICIENCY DISORDERS** By replacing abnormal stem cells with cells from a normal donor, hematopoietic cell transplantation can cure patients of a variety of immunodeficiency disorders including severe combined immunodeficiency, Wiskott-Aldrich syndrome, and Chédiak-Higashi syndrome. The widest experience has been with severe combined immunodeficiency disease, where cure rates of 90% can be expected with HLA-identical donors and success rates of 50–70% have been reported using haplotype-mismatched parents as donors (Table 29-3).

**APLASTIC ANEMIA** Transplantation from matched siblings after a preparative regimen of high-dose cyclophosphamide and antithymocyte globulin can cure up to 90% of patients <40 years with severe aplastic anemia. Results in older patients and in recipients of mismatched family member or unrelated marrow are less favorable; therefore, a trial of immunosuppressive therapy is generally recommended for such patients before considering transplantation. Transplantation is effective in all forms of aplastic anemia including, for

**TABLE 29-3**

### ESTIMATED 5-YEAR SURVIVAL RATES FOLLOWING TRANSPLANTATION<sup>a</sup>

DISEASE	ALLOGENEIC, %	AUTOLOGOUS, %
Severe combined immunodeficiency	90	N/A
Aplastic anemia	90	N/A
Thalassemia	90	N/A
Acute myeloid leukemia		
First remission	55–60	50
Second remission	40	30
Acute lymphocytic leukemia		
First remission	50	40
Second remission	40	30
Chronic myeloid leukemia		
Chronic phase	70	ID
Accelerated phase	40	ID
Blast crisis	15	ID
Chronic lymphocytic leukemia	50	ID
Myelodysplasia	45	ID
Multiple myeloma	30	35
Non-Hodgkin's lymphoma		
First relapse/second remission	40	40
Hodgkin's disease		
First relapse/second remission	40	50
Breast cancer		
High-risk stage II	N/A	70
Stage IV	N/A	15

<sup>a</sup>These estimates are generally based on data reported by the International Bone Marrow Transplant Registry. The analysis has not been reviewed by their Advisory Committee.

**Note:** N/A, not applicable; ID, insufficient data.

example, the syndromes associated with paroxysmal nocturnal hemoglobinuria and Fanconi's anemia. Patients with Fanconi's anemia are abnormally sensitive to the toxic effects of alkylating agents and so less intensive preparative regimens must be used in their treatment (Chap. 11).

**HEMOGLOBINOPATHIES** Marrow transplantation from an HLA-identical sibling following a preparative regimen of busulfan and cyclophosphamide can cure 70–90% of patients with thalassemia major. The best outcomes can be expected if patients are transplanted before they develop hepatomegaly or portal fibrosis and if they have been given adequate iron chelation therapy. Among such patients, the probabilities of 5-year survival and disease-free survival are 95 and 90%, respectively. Although prolonged survival can be achieved with aggressive chelation therapy, transplantation is

the only curative treatment for thalassemia. Transplantation is being studied as a curative approach to patients with sickle cell anemia. Two-year survival and disease-free survival rates of 90 and 80%, respectively, have been reported following matched sibling transplantation. Decisions about patient selection and the timing of transplantation remain difficult, but transplantation represents a reasonable option for younger patients who suffer repeated crises or other significant complications and who have not responded to other interventions (Chap. 8).

**OTHER NONMALIGNANT DISEASES** Theoretically, hematopoietic cell transplantation should be able to cure any disease that results from an inborn error of the lymphohematopoietic system. Transplantation has been used successfully to treat congenital disorders of white blood cells such as Kostmann's syndrome, chronic granulomatous disease, and leukocyte adhesion deficiency. Congenital anemias such as Blackfan-Diamond anemia can also be cured with transplantation. Infantile malignant osteopetrosis is due to an inability of the osteoclast to resorb bone, and because osteoclasts derive from the marrow, transplantation can cure this rare inherited disorder.

Hematopoietic cell transplantation has been used as treatment for a number of storage diseases caused by enzymatic deficiencies, such as Gaucher's disease, Hurler's syndrome, Hunter's syndrome, and infantile metachromatic leukodystrophy. Transplantation for these diseases has not been uniformly successful, but treatment early in the course of these diseases, before irreversible damage to extramedullary organs has occurred, increases the chance for success.

Transplantation is being explored as a treatment for severe acquired autoimmune disorders. These trials are based on studies demonstrating that transplantation can reverse autoimmune disorders in animal models and on the observation that occasional patients with coexisting autoimmune disorders and hematologic malignancies have been cured of both with transplantation.

## **Rx Treatment:** **MALIGNANT DISEASES**

**ACUTE LEUKEMIA** Allogeneic hematopoietic cell transplantation cures 15–20% of patients who do not achieve complete response from induction chemotherapy for acute myeloid leukemia (AML) and is the only form of therapy that can cure such patients. Cure rates of 30–35% are seen when patients are transplanted in second remission or in first relapse. The best results with allogeneic transplantation are achieved when applied during first remission, with disease-free

survival rates averaging 55–60%. Chemotherapy alone can cure a portion of AML patients, and so the relative merits of transplanting all patients during first remission versus only transplanting very-high-risk patients and those who relapse continue to be discussed. Autologous transplantation is also able to cure a portion of patients with AML. The rates of disease recurrence with autologous transplantation are higher than those seen after allogeneic transplantation, and cure rates are somewhat less.

Similar to patients with AML, adults with acute lymphocytic leukemia who do not achieve a complete response to induction chemotherapy can be cured in 15–20% of cases with immediate transplantation. Cure rates improve to 30–50% in second remission, and therefore transplantation can be recommended for adults who have persistent disease after induction chemotherapy or who have subsequently relapsed. Transplantation in first remission results in cure rates ~55%. Although transplantation appears to offer a clear advantage over chemotherapy for patients with high-risk disease, such as those with Philadelphia chromosome–positive disease, debate continues about whether adults with standard-risk disease should be transplanted in first remission or whether transplantation should be reserved until relapse. Autologous transplantation is associated with a higher relapse rate but a somewhat lower risk of nonrelapse mortality when compared to allogeneic transplantation. On balance, most experts recommend use of allogeneic stem cells if an appropriate donor is available.

**CHRONIC LEUKEMIA** Allogeneic hematopoietic cell transplantation is the only therapy shown to cure a substantial portion of patients with chronic myeloid leukemia (CML). Five-year disease-free survival rates are 15–20% for patients transplanted for blast crisis, 25–50% for accelerated-phase patients, and 60–70% for chronic phase patients, with cure rates as high as 80% at selected centers. Use of unrelated donors results in more GVHD and slightly worse survival than seen with matched siblings, although 3-year disease-free survival rates of 70% have been reported at some large centers. The timing of transplantation in CML has become more complicated with the introduction of imatinib mesylate, a remarkably effective, relatively nontoxic oral agent. Even though imatinib is not generally regarded as curative, given its favorable toxicity profile, most physicians favor its use as initial therapy for CML, with transplantation reserved for those who fail to achieve a complete cytogenetic response with imatinib, relapse after an initial response, or are intolerant of the drug (Chap. 14).

Allogeneic transplantation has been used to only a limited extent for chronic lymphocytic leukemia, in

large part because of the chronic nature of the disease and because of the age profile of patients. With allogeneic transplantation, complete remissions have been achieved in the majority of patients so far reported, with disease-free survival rates of ~50% at 3 years. However, treatment-related mortality has been substantial, and further follow-up is needed. Encouraging results have been seen using reduced intensity preparative regimens before allogeneic transplantation.

**MYELOYDYSPLASIA** Between 40 and 50% of patients with myelodysplasia appear to be cured with allogeneic transplantation. Results are better among younger patients and those with less-advanced disease. However, some patients with myelodysplasia can live for extended periods without intervention, and so transplantation is generally recommended only for patients with disease categorized as intermediate risk I or greater according to the International Prognostic Scoring System (Chap. 11).

**LYMPHOMA** Patients with disseminated intermediate- or high-grade non-Hodgkin's lymphoma who have not been cured by first-line chemotherapy and are transplanted in first relapse or second remission can still be cured in 40–50% of cases. This represents a clear advantage over results obtained with conventional-dose salvage chemotherapy. It is unsettled whether patients with high-risk disease benefit from transplantation in first remission. Most experts favor the use of autologous rather than allogeneic transplantation for patients with intermediate- or high-grade non-Hodgkin's lymphoma because fewer complications occur with this approach and survival appears equivalent. For patients with recurrent disseminated indolent non-Hodgkin's lymphoma, autologous transplantation results in high response rates and improved progression-free survival compared to salvage chemotherapy. However, late relapses are seen after transplantation. The role of autologous transplantation in the initial treatment of patients is under study. Nonmyeloablative preparative regimens followed by allogeneic transplantation result in high response rates in patients with indolent lymphomas, but the exact role of this approach remains to be defined.

The role of transplantation in Hodgkin's disease is similar to that in intermediate- and high-grade non-Hodgkin's lymphoma. With transplantation, 5-year disease-free survival is 20–30% in patients who never achieve a first remission with standard chemotherapy and up to 70% for those transplanted in second remission. Transplantation has no defined role in first remission in Hodgkin's disease.

**MYELOMA** Patients with myeloma who have progressed on first-line therapy can sometimes benefit from

allogeneic or autologous transplantation. Autologous transplantation has been studied as part of the initial therapy of patients, and both disease-free survival as well as overall survival were improved with this approach in randomized trials. The use of autologous transplantation followed by nonmyeloablative allogeneic transplantation has shown encouraging results.

**SOLID TUMORS** Among women with metastatic breast cancer, 15–20% disease-free survival rates at 3 years have been reported, with better results seen in younger patients who have responded completely to standard-dose therapy before undergoing transplantation. Randomized trials have not shown superior survival for patients treated for metastatic disease with high-dose chemotherapy plus stem cell support. Randomized trials evaluating transplantation as treatment for primary breast cancer have yielded mixed results. No role for autologous transplantation has been established in the treatment of breast cancer.

Patients with testicular cancer who have failed first-line chemotherapy have been treated with autologous transplantation; ~10–20% of such patients apparently have been cured with this approach.

The use of high-dose chemotherapy with autologous stem cell support is being studied for several other solid tumors, including ovarian cancer, small cell lung cancer, neuroblastoma, and pediatric sarcomas. As in most other settings, the best results have been obtained in patients with limited amounts of disease and where the remaining tumor remains sensitive to conventional-dose chemotherapy. Few randomized trials of transplantation in these diseases have been completed.

Partial and complete responses have been reported following nonmyeloablative allogeneic transplantation for some solid tumors, most notably renal cell cancers. The GVT effect, well documented in the treatment of hematologic malignancies, may apply to selected solid tumors under certain circumstances.

**POSTTRANSPLANT RELAPSE** Patients who relapse following autologous transplantation sometimes respond to further chemotherapy, particularly if the remission following transplantation was long. More options are available for patients who relapse following allogeneic transplantation. Of particular interest are the response rates seen with infusion of unirradiated donor lymphocytes. Complete responses in as many as 75% of patients with chronic myeloid leukemia, 40% in myelodysplasia, 25% in AML, and 15% in myeloma have been reported. Major complications of donor lymphocyte infusions include transient myelosuppression and the development of GVHD. These complications depend on the number of donor lymphocytes given and the schedule of infusions, with less GVHD seen with lower dose, fractionated schedules.

## FURTHER READINGS

- ADELBERG DE, BISHOP MR: Emergencies related to cancer chemotherapy and hematopoietic stem cell transplantation. *Emerg Med Clin North Am* 27:311, 2009
- APPELBAUM FR: Haematopoietic cell transplantation as immunotherapy. *Nature* 411:385, 2001
- BARON F, STORB R: Hematopoietic stem cell transplantation after reduced-intensity conditioning for older adults with acute myeloid leukemia. *Curr Opin Hematol* 14:145, 2007
- BENSINGER WI et al: Transplantation of bone marrow as compared with peripheral-blood cells from HLA-identical relatives in patients with hematologic cancers. *N Engl J Med* 344:175, 2001

- COPELAN EA: Hematopoietic stem-cell transplantation. *N Engl J Med* 354:1813, 2006
- HIEMENZ JW: Management of infections complicating allogeneic hematopoietic stem cell transplantation. *Semin Hematol* 46:289, 2009
- PETERSDORF EW et al: Major-histocompatibility-complex class I alleles and antigens in hematopoietic-cell transplantation. *N Engl J Med* 345:1794, 2001
- PIDALA J et al: Quality of life after allogeneic hematopoietic cell transplantation. *Blood* 114:7, 2009
- WILLIAMS KM et al: Bronchiolitis obliterans after allogeneic hematopoietic stem cell transplantation. *JAMA* 302:306, 2009

## CHAPTER 30

# PALLIATIVE AND END-OF-LIFE CARE

Ezekiel J. Emanuel ■ Joshua Hauser ■ Linda L. Emanuel

■ Epidemiology . . . . .	.398	Withdrawing and Withholding Life-Sustaining Treatment . . .	.414
■ Hospice and the Palliative Care Framework . . . . .	.399	Futile Care . . . . .	.415
Assessment and Care Planning . . . . .	.399	Euthanasia and Physician-Assisted Suicide . . . . .	.415
■ Interventions . . . . .	.404	Care During the Last Hours . . . . .	.416
Physical Symptoms and Their Management . . . . .	.404	■ Palliative Care Services: How and Where . . . . .	.419
Psychological Symptoms and Their Management . . . . .	.409	■ Future Directions . . . . .	.419
Social Needs and Their Management . . . . .	.412	Outcome Measures . . . . .	.419
Existential Needs and Their Management . . . . .	.413	■ Further Readings . . . . .	.419
■ Managing the Last Stages . . . . .	.414		

### EPIDEMIOLOGY

In 2003, 2,448,288 individuals died in the United States (Table 30-1). Over 70% of all deaths occur in those >65 years of age. The epidemiology of mortality is similar in most developed countries; cardiovascular diseases

and cancer are the predominant causes of death, a marked change since 1900 when heart disease caused ~8% of all deaths and cancer accounted for <4% of all deaths. In 2003, AIDS accounted for <1% of all deaths, although among those ages 35–44, it remains a leading cause of death.

**TABLE 30-1**

**TEN LEADING CAUSES OF DEATH IN THE UNITED STATES AND BRITAIN**

CAUSE OF DEATH	UNITED STATES			BRITAIN	
	NUMBER OF DEATHS	PERCENT OF TOTAL	NUMBER OF DEATHS AMONG PEOPLE ≥65 YEARS OF AGE	NUMBER OF DEATHS	PERCENT OF TOTAL
All deaths	2,448,288	100	1,804,373	538,254	100
Heart disease	685,089	28	563,390	129,009	24
Cancer	556,902	22.7	388,390	135,955	25.3
Stroke	157,689	6.4	138,134	57,808	10.7
Chronic obstructive pulmonary disease	126,382	5.2	109,139	27,905	5.2
Accidents	109,277	4.5	34,335	10,979	2
Diabetes	74,219	3	54,919	6316	1.2
Pneumonia/influenza	65,163	2.7	57,670	34,477	6.4
Alzheimer's disease	63,457	2.6	62,814	5055	0.9
Nephritis, nephritic syndrome, nephrosis	42,453	1.7	35,254	3287	0.6
Septicemia	34,069	1.3	26,445	2206	0.4

Source: National Center for Health Statistics (2003) <http://www.cdc.gov/nchs>; National Statistics (Great Britain, 2003) <http://www.statistics.gov.uk>.

Central to this type of care is an interdisciplinary team approach that typically encompasses pain and symptom management, spiritual and psychological care for the patient, and support for family caregivers during the patient's illness and the bereavement period.

Terminally ill patients have a wide variety of advanced diseases, often with multiple symptoms demanding relief, and require noninvasive therapeutic regimens to be delivered in flexible care settings. Fundamental to ensuring quality palliative and end-of-life care is a focus on four broad domains: (1) physical symptoms; (2) psychological symptoms; (3) social needs that include interpersonal relationships, caregiving, and economic concerns; and (4) existential or spiritual needs.

A comprehensive assessment screens for and evaluates needs in each of these four domains. Goals for care are established in discussion with the patient and/or family based on the assessment in each of these domains. Interventions are then aimed at improving or managing symptoms and needs. Although physicians are responsible for certain especially technical interventions, and for coordinating the interventions, they cannot be responsible for providing all of them. Because failing to address any one of the domains is likely to preclude a good death, a well-coordinated, effectively communicating interdisciplinary team takes on special importance in end-of-life care. Depending on the setting, critical members of the interdisciplinary team include physicians, nurses, social workers, chaplains, nurse's aides, physical therapists, bereavement counselors, and volunteers.

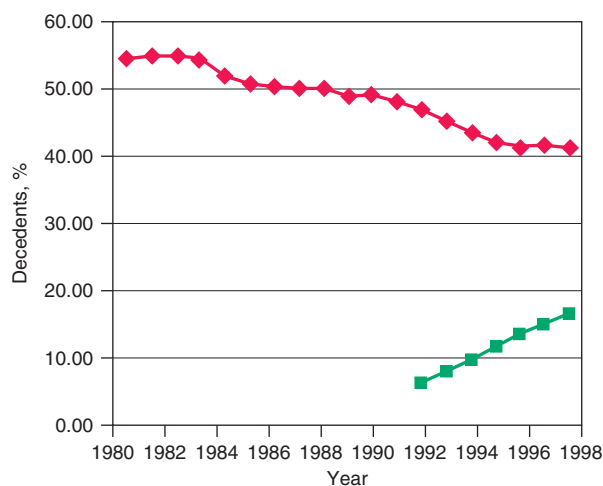
### ASSESSMENT AND CARE PLANNING

#### Comprehensive Assessment

Standardized methods for conducting a comprehensive assessment focus on evaluating the patient's condition in all four domains affected by illness: physical, psychological, social, and spiritual. The assessment of physical and mental symptoms should follow a modified version of the traditional medical history and physical examination that emphasizes symptoms. Questions should aim at elucidating symptoms and discerning sources of suffering and gauging how much these symptoms interfere with the patient's quality of life. Standardized assessment is critical. Currently, there are 21 symptom assessment instruments for cancer alone. Instruments with good psychometric properties that assess a wide range of symptoms include the Memorial Symptom Assessment Scale (MSAS), the Rotterdam Symptom Checklist, the Worthing Chemotherapy Questionnaire, and the Computerized Symptom Assessment Instrument. These are long and may be useful for initial clinical or for research

It is estimated that in developed countries ~70% of all deaths are preceded by a disease or condition such that it is reasonable to plan for dying in the foreseeable future. Cancer has served as the paradigm for terminal care, but it is not the only type of illness with a recognizable and predictable terminal phase. Because heart failure, chronic obstructive pulmonary disease (COPD), chronic liver failure, dementia, and many other conditions have recognizable terminal phases, a systematic approach to end-of-life care should be part of all medical specialties. Many patients with illness-related suffering can also benefit from palliative care, regardless of prognosis. Ideally, palliative care should be considered as a part of comprehensive care for all patients.

Over the past few decades in the United States, a significant change in the site of death has occurred that coincides with patient and family preferences. Nearly 60% of Americans died as inpatients in hospitals in 1980. By 2000, the trend was reversing, with ~40% of Americans dying as hospital inpatients (Fig. 30-1). This shift has been most dramatic for those dying from cancer and COPD and for younger and very old individuals. In the past decade, it is associated with the increased use of hospice care; in 2005, ~33% of all decedents in the United States received such care. Cancer patients currently constitute ~50% of hospice users, with ~60% of all terminal cancer patients receiving hospice care. About 70% of patients receiving hospice care die out of the hospital. In addition, with shortening of hospital stays, many serious conditions are being treated at home or on an outpatient basis. Consequently, providing optimal palliative and end-of-life care requires ensuring that appropriate services are available in a variety of settings, including noninstitutional settings.



**FIGURE 30-1**

Graph showing trends in the site of death in the past two decades. ◆, percentage of hospital inpatient deaths; ■, percentage of decedents enrolled in a hospice.



400 assessments. Shorter instruments are useful for patients whose performance status does not permit comprehensive assessments. Suitable shorter instruments include the Condensed Memorial Symptom Assessment Scale, the Edmonton Symptom Assessment System, the M.D. Anderson Symptom Assessment Inventory, and the Symptom Distress Scale. Using such instruments ensures that the assessment is comprehensive and does not just focus on pain and a few other physical symptoms. Invasive tests are best avoided in end-of-life care, and even minimally invasive tests should be carefully evaluated for their benefit-to-burden ratio for the patient. Aspects of the physical examination that are uncomfortable and unlikely to yield useful information can also be omitted.

Regarding social needs, health care providers should assess the status of important relationships, financial burdens, caregiving needs, and access to medical care. Relevant questions will include: *How often is there someone to feel close to? How has this illness been for your family? How has it affected your relationships? How much help do you need with things like getting meals or getting around? How much trouble do you have getting the medical care you need?* In the area of existential needs, providers should assess distress and the patient's sense of being emotionally and existentially settled and of finding purpose or meaning. Helpful assessment questions can include: *How much are you able to find meaning since your illness began? What things are most important to you at this stage?* In addition, it can be helpful to ask about how well the patient perceives his or her care to be: *How much do you feel your doctors and nurses respect you? How clear is the information from us about what to expect regarding your illness? How much do you feel that the medical care you are getting fits with your goals?* If concern is detected in any of these areas, deeper evaluative questions are warranted.

### Communication

Especially when an illness is life-threatening, there are many emotionally charged and potentially conflict-creating moments, collectively called “bad news” situations, in which empathic and effective communication skills are essential. These moments include communicating to the patient and/or family about a terminal diagnosis, the patient's prognosis, any treatment failures, deemphasizing efforts to cure and prolong life while focusing more on symptom management and palliation, advance care planning, and the patient's death.

Just as surgeons plan and prepare for major operations or investigators rehearse a presentation of research results, physicians and health care providers caring for patients with significant or advanced illness can develop a practiced approach to sharing important information and planning interventions. In addition, families identify as important both how well the physician was prepared to deliver bad news and the setting in which it was

delivered. For instance, 27% of families making critical decisions for patients in an intensive care unit (ICU) desired better and more private physical space to communicate with physicians, and 48% found having clergy present reassuring.

An organized and effective procedure for communicating bad news with seven steps goes by the acronym P-SPIKES: (1) **p**repare for the discussion, (2) **s**et up a suitable environment, (3) begin the discussion by finding out what the **p**atient and/or family understand, (4) determine how they will comprehend new **i**nformation best and how much they want to know, (5) provide needed new **k**nowledge accordingly, (6) allow for **e**motional responses, and (7) **s**hare plans for the next steps in care. **Table 30-2** provides a summary of these steps along with suggested phrases and underlying rationales for each.

### Continuous Goal Assessment

Major barriers to ensuring quality palliative and end-of-life care include difficulty in providing an accurate prognosis and emotional resistance of patients and their families to accepting the implications of a poor prognosis. A practical solution to these barriers is to integrate palliative care with curative care regardless of prognosis. With this approach, palliative care no longer conveys the message of failure, having no more treatments, or “giving up hope.” Fundamental to integrating palliative care with curative therapy is to include continuous goal assessment as part of the routine patient reassessment that occurs at most patient-physician encounters.

Goals for care are numerous, ranging from cure of a specific disease, to prolonging life, to relief of a symptom, to delaying the course of an incurable disease, to adapting to progressive disability without disrupting the family, to finding peace of mind or personal meaning, to dying in a manner that leaves loved ones with positive memories. Discernment of goals for care can be approached through a seven-step protocol: (1) ensure that medical and other information is as complete as reasonably possible and understood by all relevant parties (see earlier); (2) explore what the patient and/or family are hoping for while identifying relevant and realistic goals; (3) share all the options with the patient and family; (4) respond with empathy as they adjust to changing expectations; (5) make a plan, emphasizing what can be done toward the realistic goals; (6) follow through with the plan; and (7) review and revise this plan periodically, considering at every encounter whether the goals of care should be reviewed with the patient and/or family. Each of these steps need not be followed in rote order, but together they provide a helpful framework for interactions with patients and their families about goals for care. It can be especially challenging if a patient or family member has difficulty letting go of an unrealistic goal. One strategy is to help them refocus on more realistic goals, and also

TABLE 30-2

## ELEMENTS OF COMMUNICATING BAD NEWS—THE P-SPIKES APPROACH

ACRONYM	STEPS	AIM OF THE INTERACTION	PREPARATIONS, QUESTIONS, OR PHRASES
P	Preparation	Mentally prepare for the interaction with the patient and/or family.	Review what information needs to be communicated. Plan how you will provide emotional support. Rehearse key steps and phrases in the interaction.
S	Setting of the interaction	Ensure the appropriate setting for a serious and potentially emotionally charged discussion.	Ensure patient, family, and appropriate social supports are present. Devote sufficient time. Ensure privacy and prevent interruptions by people or beeper. Bring a box of tissues.
P	Patient's perception and preparation	Begin the discussion by establishing the baseline and whether the patient and family can grasp the information. Ease tension by having the patient and family contribute.	Start with open-ended questions to encourage participation. Possible phrases to use: <i>What do you understand about your illness?</i> <i>When you first had symptom X, what did you think it might be?</i> <i>What did Dr. X tell you when he sent you here?</i> <i>What do you think is going to happen?</i>
I	Invitation and information needs	Discover what information needs the patient and/or family have and what limits they want regarding the bad information.	Possible phrases to use: <i>If this condition turns out to be something serious, do you want to know?</i> <i>Would you like me to tell you all the details of your condition? If not, then who would you like me to talk to?</i>
K	Knowledge of the condition	Provide the bad news or other information to the patient and/or family sensitively.	Do not just dump the information on the patient and family. Check for patient and family understanding. Possible phrases to use: <i>I feel bad to have to tell you this, but . . .</i> <i>Unfortunately, the tests showed . . .</i> <i>I'm afraid the news is not good . . .</i>
E	Empathy and exploration	Identify the cause of the emotions—e.g., poor prognosis. Empathize with the patient and/or family's feeling.  Explore by asking open-ended questions.	Strong feelings in reaction to bad news are normal. Acknowledge what the patient and family are feeling. Remind them such feelings are normal, even if frightening. Give them time to respond. Remind patient and family you won't abandon them. Possible phrases to use: <i>I imagine this is very hard for you to hear.</i> <i>You look very upset. Tell me how you are feeling.</i> <i>I wish the news were different.</i> <i>We'll do whatever we can to help you.</i>
S	Summary and planning	Delineate for the patient and the family the next steps, including additional tests or interventions.	It is the unknown and uncertain that can increase anxiety. Recommend a schedule with goals and landmarks. Provide your rationale for the patient and/or family to accept (or reject). If the patient and/or family are not ready to discuss the next steps, schedule a follow-up visit.

Source: Adapted from Buckman (1992).

402 suggest that, while hoping for the best, it is still prudent to plan for other outcomes as well.

## Advance Care Planning

### Practices

Advance care planning is a process of planning for future medical care in case the patient becomes incapable of making medical decisions. Ideally, such planning would occur before a health care crisis or the terminal phase of an illness. Unfortunately, diverse barriers prevent this. Although 80% of Americans endorse advance care planning and completing living wills, only 29% have actually done so. Most patients expect physicians to initiate advance care planning and wait for physicians to broach the subject. Patients also wish to discuss advance care planning with their families. Yet patients with unrealistic expectations are significantly more likely to prefer aggressive treatments. Fewer than a third of health care providers have completed advance care planning for themselves. Hence a good first step is for health care providers to complete advance care planning for themselves. This makes providers aware of the critical choices in the process and the issues that are especially charged and allows them to tell their patients truthfully that they have done advance planning themselves.

Steps in effective advance care planning center on (1) introducing the topic, (2) structuring a discussion, (3) reviewing plans that have been discussed by the patient and family, (4) documenting the plans, (5) updating them periodically, and (6) implementing the advance care directives (Table 30-3). Two of the main barriers to advance care planning are problems in raising the topic and structuring a succinct discussion. Raising the topic can be done efficiently as a routine matter, noting that it is recommended for all patients, analogous to purchasing insurance or estate planning. Almost all of the most difficult cases have involved unexpected, acute episodes of brain damage in young individuals.

Structuring a focused discussion is a central communication skill. Identify the health care proxy and recommend his or her involvement in the advance care planning process. Select a worksheet, preferably one that has been evaluated and demonstrated to produce reliable and valid expressions of patient preferences, and orient the patient and proxy to it. Such worksheets exist for both general and disease-specific situations. Discuss with the patient and proxy one scenario as an example to demonstrate how to think about the issues. It is often helpful to begin with a scenario in which the patient is likely to have settled preferences for care, such as being in a persistent vegetative state. Once the patient's preferences for interventions in this scenario are determined, suggest that the patient and proxy discuss and complete the worksheet for the others. If appropriate, suggest they involve other family members in the discussion. On a return visit, go over the patient's

preferences, checking and resolving any inconsistencies. After having the patient and proxy sign the document, place it in the medical chart and be sure that copies are provided to relevant family members and care sites. Because patients' preferences can change, these documents need to be reviewed periodically.

### Types of Documents

Advance care planning documents are of two broad types. The first includes living wills or instructional directives; these are advisory documents that describe the types of decisions that should direct care. Some are more specific, delineating different scenarios and interventions for the patient to choose from. Among these, some are for general use and others are designed for use by patients with a specific type of disease, such as cancer or HIV. Less specific directives can be general statements of not wanting life-sustaining interventions or forms that describe the values that should guide specific terminal care decisions. The second type of advance directive allows the designation of a health care proxy (sometimes also referred to as a durable attorney for health care) who is an individual selected by the patient to make decisions. The choice is not either/or; a combined directive that includes a living will and designates a proxy is often used, and the directive should clearly indicate whether the specified patient preferences or the proxy's choice takes precedence if they conflict.

A potentially misleading distinction relates to statutory as opposed to advisory documents. Statutory documents are drafted to fulfill relevant state laws. Advisory documents are drafted to reflect the patient's wishes. Both are legal, the first under state law, and the latter under common or constitutional law.

### Legal Aspects

As of 2006, 48 states and the District of Columbia had enacted living will legislation. Many states have their own statutory forms. Massachusetts and Michigan do not have living will laws, although both have health care proxy laws. In 25 states, the laws state that the living will is not valid if a woman is pregnant. However, like all other states except Alaska, these states have enacted durable power of attorney for health care laws that permit patients to designate a proxy decision maker with authority to terminate life-sustaining treatments. Only in Alaska does the law prohibit proxies from terminating life-sustaining treatments.

The U.S. Supreme Court has ruled that patients have a constitutional right to decide about refusing and terminating medical interventions, including life-sustaining interventions, and that mentally incompetent patients can exercise this right by providing "clear and convincing evidence" of their preferences. Because advance care directives permit patients to provide such evidence, commentators agree that they are constitutionally protected. Most

TABLE 30-3

## STEPS IN ADVANCE CARE PLANNING

STEP	GOALS TO BE ACHIEVED AND MEASURES TO COVER	USEFUL PHRASES OR POINTS TO MAKE
Introducing advance care planning	<p>Ask the patient what he or she knows about advance care planning and if he or she has already completed an advanced care directive.</p> <p>Indicate that you as a physician have completed advance care planning.</p> <p>Indicate that you try to perform advance care planning with all patients regardless of prognosis.</p> <p>Explain the goals of the process as empowering the patient and ensuring you and the proxy understand the patient's preferences.</p> <p>Provide the patient relevant literature including the advance care directive that you prefer to use.</p> <p>Recommend the patient identify a proxy decision-maker who should attend the next meeting.</p>	<p><i>I'd like to talk with you about something I try to discuss with all my patients. It's called advance care planning. In fact, I feel that this is such an important topic that I have done this myself. Are you familiar with advance care planning or living wills?</i></p> <p><i>Have you thought about the type of care you would want if you ever became too sick to speak for yourself? That is the purpose of advance care planning. There is no change in health that we have not discussed. I am bringing this up now because it is sensible for everyone, no matter how well or ill, old or young.</i></p> <p>Have many copies of advance care directives available, including in the waiting room, for patients and families.</p> <p>Know resources for state-specific forms (available at <a href="http://www.nhpco.org">www.nhpco.org</a>).</p>
Structured discussion of scenarios and patient	<p>Affirm that the goal of the process is to follow the patient's wishes if the patient loses decision-making capacity.</p> <p>Elicit the patient's overall goals related to health care.</p> <p>Elicit the patient's preferences for specific interventions in a few salient and common scenarios.</p> <p>Help the patient define the threshold for withdrawing and withholding interventions.</p> <p>Define the patient's preference for the role of the proxy.</p>	<p>Use a structured worksheet with typical scenarios. Begin the discussion with persistent vegetative state and consider other scenarios, such as recovery from an acute event with serious disability, asking the patient about his or her preferences regarding specific interventions, such as ventilators, artificial nutrition, and CPR, and then proceeding to less-invasive interventions, such as blood transfusions and antibiotics.</p>
Review the patient's preferences	<p>After the patient has made choices of interventions, review them to ensure they are consistent and the proxy is aware of them.</p>	
Document the patient's preferences	<p>Formally complete the advance care directive and have witness sign it.</p> <p>Provide a copy for the patient and the proxy.</p> <p>Insert a copy into the patient's medical record and summarize in a progress note.</p>	
Update the directive	<p>Periodically, and with major changes in health status, review the directive with the patient and make any modifications.</p>	
Apply the directive	<p>The directive goes into effect only when the patient becomes unable to make medical decisions for him- or herself.</p> <p>Re-read the directive to be sure about its content.</p> <p>Discuss your proposed actions based on the directive with the proxy.</p>	

**Note:** CPR, cardiopulmonary resuscitation.

commentators believe that a state is required to honor any clear advance care directive, whether or not it is written on an "official" form. Many states have enacted laws to explicitly honor out-of-state directives. If a patient is not using a statutory form, then it might be advisable to

attach a statutory form to the advance care directive being used. State-specific forms are readily available free of charge for health care providers and patients and families through the website of the National Hospice and Palliative Care Organization (<http://www.nhpco.org>).

## PHYSICAL SYMPTOMS AND THEIR MANAGEMENT

Great emphasis has been placed on addressing dying patients' pain. Some institutions have made pain assessment a fifth vital sign to emphasize its importance. This has also been advocated by large health care systems, such as the Veterans' Administration and accrediting bodies such as the Joint Commission on the Accreditation of Health Care Organizations (JCAHO). Although this embrace of pain as the fifth vital sign has been symbolically important, no data document that it has changed pain management practices. Although good palliative care requires good pain management, it also requires more. The frequency of symptoms varies by disease and other factors. The most common physical and psychological symptoms among all terminally ill patients include pain, fatigue, insomnia, anorexia, dyspnea, depression, anxiety, and nausea and vomiting. In the last days of life, terminal delirium is also common. Assessments of patients with advanced cancer have shown that patients experienced an average of 11.5 different physical and psychological symptoms (Table 30-4).

Evaluations to determine the etiology of these symptoms can usually be limited to the history and physical examination. In some cases, radiologic or other diagnostic examinations provide sufficient benefit in directing optimal palliative care to warrant the risks, potential discomfort, and inconvenience especially to the seriously ill patient. Only a few of the common symptoms presenting difficult management issues are addressed in this

**TABLE 30-4**

### COMMON PHYSICAL AND PSYCHOLOGICAL SYMPTOMS OF TERMINALLY ILL PATIENTS

PHYSICAL SYMPTOMS	PSYCHOLOGICAL SYMPTOMS
Pain	Anxiety
Fatigue and weakness	Depression
Dyspnea	Hopelessness
Insomnia	Meaninglessness
Dry mouth	Irritability
Anorexia	Impaired concentration
Nausea and vomiting	Confusion
Constipation	Delirium
Cough	Loss of libido
Swelling of arms or legs	
Itching	
Diarrhea	
Dysphagia	
Dizziness	
Fecal and urinary incontinence	
Numbness/tingling in hands/feet	

chapter. Additional information on the management of nausea and other symptoms can be found in Chap. 25.

## Pain

### Frequency

The frequency of pain among terminally ill patients varies widely. Substantial pain occurs in 36–90% of patients with advanced cancer. In the SUPPORT study of hospitalized patients with diverse conditions and an estimated survival of  $\leq 6$  months, 22% reported moderate to severe pain, and caregivers of these patients noted that 50% had similar levels of pain during the last few days of life.

### Etiology

*Nociceptive pain* is the result of direct mechanical or chemical stimulation of nociceptors and normal neural signaling to the brain. It tends to be localized, aching, throbbing, and cramping. The classic example is bone metastases. *Visceral pain* is caused by nociceptors in gastrointestinal, respiratory, and other organ systems. It is a deep or colicky type of pain classically associated with pancreatitis, myocardial infarction, or tumor invasion of viscera. *Neuropathic pain* arises from disordered nerve signals. It is described by patients as burning, electrical, or shocklike pain. Classic examples are poststroke pain, tumor invasion of the brachial plexus, and herpetic neuralgia.

### Assessment

Pain is a subjective experience. Depending on the patient's circumstances, perspective, and physiologic condition, the same physical lesion or disease state can produce different levels of reported pain and need for pain relief. Systematic assessment includes eliciting the following: (1) type: throbbing, cramping, burning, etc. (2) periodicity: continuous, with or without exacerbations, or incident; (3) location; (4) intensity; (5) modifying factors; (6) effects of treatments; (7) functional impact; and (8) impact on patient. Several validated pain assessment measures may be used, such as the Visual Analogue Scale, the Brief Pain Inventory, and the pain component of one of the more comprehensive symptom assessment instruments. Frequent reassessments are essential to assess the effects of interventions.

### Interventions

Interventions for pain must be tailored to each individual with the goal of preempting chronic pain and relieving breakthrough pain. At the end of life, there is rarely reason to doubt the patient's report of pain. Pain medications are the cornerstone of management. If these are failing and nonpharmacologic interventions—including radiotherapy, anesthetic or neurosurgical procedures, such as peripheral nerve blocks or epidural medications—are required, a pain consultation is appropriate.

Pharmacologic interventions follow the World Health Organization three-step approach involving nonopioid analgesics, mild opioids, and strong opioids, with or without adjuvants. Nonopioid analgesics, especially nonsteroidal anti-inflammatory drugs (NSAIDs), are the initial treatments for mild pain. They work primarily by inhibiting peripheral prostaglandins, reducing inflammation, but may also have central nervous system (CNS) effects. They have a ceiling effect. Ibuprofen, up to 1600 mg/d qid, has a minimal risk of bleeding and renal impairment and is a good initial choice. In patients with a history of severe gastrointestinal (GI) or other bleeding, it should be avoided. In patients with a history of mild gastritis or gastroesophageal reflux disease (GERD), acid-lowering therapy, such as a proton-pump inhibitor, should be used. Acetaminophen is an alternative in patients with a history of GI bleeding and can be used safely at up to 4 g/d, qid. In patients with liver dysfunction due to metastases or other causes or in patients with heavy alcohol use, doses should be reduced.

If nonopioid analgesics are insufficient, then opioids should be introduced. They work by interacting with mu opioid receptors in the CNS to activate pain-inhibitory neurons; most are receptor antagonists. The mixed agonist/antagonist opioids useful for postacute pain should not be used for the chronic pain in end-of-life care. Weak opioids, such as codeine, can be used initially. However, if these are escalated and fail to relieve pain, then strong opioids, such as morphine 5–10 mg every 4 h, should be used. Nonopioid analgesics should be combined with opioids because they potentiate the effect of opioids.

For continuous pain, opioids should be administered on a regular, around-the-clock basis consistent with their duration of analgesia. They should not be provided only when the patient experiences pain; the goal is to prevent patients from experiencing pain. Patients should also be provided rescue medication, such as liquid morphine, for breakthrough pain that should generally be 20% of the baseline dose. Patients should be informed that using the rescue medication does not obviate their taking the next standard dose of pain medication. If after 24 h the patient's pain remains uncontrolled and recurs before the next dose, requiring the patient to use the rescue medication, the daily opioid dose can be increased by the total dose of rescue medications used by the patient, or by 50% for moderate pain and 100% for severe pain of the standing opioid daily dose.

It is inappropriate to start with extended-release preparations. Instead, an initial focus on using short-acting preparations to determine how much is required in the first 24–48 h will allow clinicians to determine opioid needs. Once pain relief is obtained with short-acting preparations, then switch to extended-release preparations. Even with a stable extended-release preparation regimen, the patient may have incident pain, such as

during movement or dressing changes. Short-acting preparations should be taken before such predictable episodes. Although less common, patients may have “end-of-dose failure” with long-acting opioids, meaning that they develop pain after 8 h in the case of an every 12-h medication. In these cases, a trial of giving an every 12-h medication every 8 h is appropriate.

Because of differences in opioid receptors, cross-tolerance among opioids is incomplete and patients may experience different side effects with different opioids. Therefore, if a patient is not experiencing pain relief or is experiencing too many side effects, change to another opioid preparation is appropriate. When switching, begin with 50–75% of the published equianalgesic dose of the new opioid.

Unlike NSAIDs, opioids have no ceiling effect; therefore, there is no maximum dose no matter how many milligrams the patient is receiving. The appropriate dose is the dose needed to achieve pain relief. This is an important point for clinicians to explain to patients and families. Addiction or excessive respiratory depression is extremely unlikely in the terminally ill; fear of these side effects should neither prevent escalating opioid medications when the patient is experiencing insufficient pain relief nor justify using opioid antagonists.

Opioid side effects should be anticipated and treated preemptively. Nearly all patients experience constipation that can be debilitating (see later). Failure to prevent constipation often results in noncompliance with opioid therapy. Methylnaltrexone is a drug that targets opioid-induced constipation by blocking peripheral opioid receptors but not central receptors for analgesia. In placebo-controlled trials, it has been shown to cause laxation within 24 h of administration. As with the use of opioids, about a third of patients using methylnaltrexone experience nausea and vomiting, but unlike constipation, tolerance develops, usually within a week. Therefore, when beginning opioids, an antiemetic, such as metoclopramide or a serotonin antagonist, is often prescribed prophylactically and stopped after 1 week. Olanzapine has also been shown to have anti-nausea properties and can also be effective in countering delirium or anxiety, with the advantage of some weight gain.

Drowsiness, a common side effect of opioids, also usually abates within a week. During this period, drowsiness can be treated with psychostimulants, such as dextroamphetamine, methylphenidate, or modafinil. Modafinil has the advantage of every day dosing. Pilot reports suggest that donepezil may also be helpful for opiate-induced drowsiness, as well as relieving fatigue and anxiety. Metabolites of morphine and most opioids are cleared renally; doses may need to be adjusted for patients with renal failure.

Seriously ill patients with chronic pain relief rarely if ever become addicted. Suspicion of addiction should

406 not be a reason to withhold pain medications from terminally ill patients. Patients and families may withhold prescribed opioids for fear of addiction or dependence. Physicians and health care providers should reassure patients and families that the patient will not become addicted to opioids if used as prescribed for pain relief; this fear should not prevent the patient from taking the medications around the clock. However, diversion of drugs for use by other family members or illicit sale may occur. It may be necessary to advise the patient and caregiver about secure storage of opioids. Contract writing with the patient and family can help. If that fails, transfer to a safe facility may be necessary.

Tolerance is the need for increasing medication dosage for the same pain relief without a change in disease. In the case of patients with advanced disease, the need for increasing opioid dosage for pain relief is usually caused by disease progression rather than tolerance. Physical dependence is indicated by symptoms from the abrupt withdrawal of opioids and should not be confused with addiction.

Adjuvant analgesic medications are nonopioids that potentiate the analgesic effects of opioids. They are especially important in the management of neuropathic pain. Gabapentin, an anticonvulsant initially studied in the setting of herpetic neuralgia, is now the first-line treatment for neuropathic pain from a variety of causes. It is begun at 100–300 mg bid or tid, with 50–100% dose increments every 3 days. Usually 900–3600 mg/d in two or three doses is effective. One potential side effect to be aware of is confusion and drowsiness, especially in the elderly. Other effective adjuvant medications include pregabalin, which has the same mechanism of action as gabapentin but is more efficiently absorbed from the GI tract. Lamotrigine is a novel agent whose mechanism of action is unknown, but it has shown effectiveness. It is recommended to begin at 25–50 mg/d increasing to 100 mg/d. Carbamazepine, a first-generation agent, has been proven effective in randomized trials for neuropathic pain. Other potentially effective anticonvulsant adjuvants include topiramate (25–50 mg qd or bid rising to 100–300 mg/d) and oxcarbazepine (75–300 mg bid, rising to 1200 mg bid). Glucocorticoids, preferably dexamethasone given once a day, can be useful in reducing inflammation that causes pain while elevating mood, energy, and appetite. Its main side effects include confusion, sleep difficulties, and fluid retention. Glucocorticoids are especially effective for bone pain and abdominal pain from distention of the GI tract or liver. Other drugs, including clonidine and baclofen, can be effective in pain relief. These drugs are adjuvants and should generally be used in conjunction with—not instead of—opioids. Methadone, carefully dosed because of unpredictable half-life in many patients, has activity at the *N*-methyl D-aspartate (NMDA) receptor and is useful for complex pain

syndromes and neuropathic pain. It is generally reserved for cases when first-line opioids (morphine, oxycodone, hydromorphone) are either ineffective or unavailable.

Radiation therapy can treat bone pain from single metastatic lesions. Bone pain from multiple metastases can be amenable to radiopharmaceuticals, such as strontium 89 and samarium 153. Bisphosphonates [such as pamidronate (90 mg every 4 weeks)] and calcitonin (200 IU intranasally once or twice a day) also provide relief from bone pain but have onset of action of days.

## Constipation

### Frequency

Constipation is reported in up to 90% of terminally ill patients.

### Etiology

Although hypercalcemia and other factors can cause constipation, it is most frequently a predictable consequence of the use of opioids for the relief of pain and dyspnea and of tricyclic antidepressants, from their anticholinergic effects, as well as of the inactivity and poor diet that are common among seriously ill patients. If untreated, constipation can cause substantial pain and vomiting and is also associated with confusion and delirium. Whenever opioids and other medications known to cause constipation are used, preemptive treatment for constipation should be instituted.

### Assessment

Establish the patient's previous bowel habits, including the frequency, consistency, and volume. Abdominal and rectal examinations should be performed to exclude impaction or acute abdomen. Radiographic assessments beyond a simple flat plate of the abdomen in cases where obstruction is suspected are rarely necessary.

### Intervention

Although physical activity, adequate hydration, and dietary treatments with fiber can be helpful, each is limited in its effectiveness for most seriously ill patients, and fiber may exacerbate problems in the setting of dehydration and if impaired motility is the etiology. Fiber is contraindicated in the presence of opioid use. Stimulant and osmotic laxatives, stool softeners, fluids, and enemas are the mainstays of therapy (Table 30-5). When preventing constipation from opioids and other medications, a combination of a laxative and stool softener (such as senna and docusate) should be used. If after several days of treatment a bowel movement has not occurred, a rectal examination to remove impacted stool and to place a suppository is necessary. For patients with impending bowel obstruction or gastric stasis, octreotide to reduce secretions can be helpful. For patients in

TABLE 30-5

## MEDICATIONS FOR THE MANAGEMENT OF CONSTIPATION

INTERVENTION	DOSE	COMMENT
Stimulant laxatives		These agents directly stimulate peristalsis and may reduce colonic absorption of water.
Prune juice	120–240 mL/d	
Senna (Senokot)	2–8 tablets PO bid	
Bisacodyl	5–15 mg/d PO, PR	Work in 6–12 h.
Osmotic laxatives		These agents are not absorbed. They attract and retain water in the gastrointestinal tract.
Lactulose	15–30 mL PO q4–8h	Lactulose may cause flatulence and bloating.
Magnesium hydroxide (Milk of Magnesia)	15–30 mL/d PO	
Magnesium citrate	125–250 mL/d PO	Lactulose works in 1 day; magnesium products in 6 h.
Stool softeners		These agents work by increasing water secretion and as detergents increasing water penetration into the stool.
Sodium docusate (Colace)	300–600 mg/d PO	
Calcium docusate	300–600 mg/d PO	Work in 1–3 days.
Suppositories and enemas		
Bisacodyl	10–15 PR qd	
Sodium phosphate enema	PR qd	Fixed dose, 4.5 oz, Fleet's.

whom the suspected mechanism is dysmotility, metoclopramide can be helpful.

### Nausea

#### Frequency

Up to 70% of patients with advanced cancer have nausea, defined as the subjective sensation of wanting to vomit.

#### Etiology

Nausea and vomiting are both caused by stimulation at one of four sites: the GI tract, the vestibular system, the chemoreceptor trigger zone (CTZ), and the cerebral cortex. Medical treatments of nausea are aimed at receptors at each of these sites: The GI tract contains mechanoreceptors, chemoreceptors, and 5-hydroxytryptamine type 3 (5-HT<sub>3</sub>) receptors; the vestibular system likely contains histamine and acetylcholine receptors; and the CTZ contains chemoreceptors, dopamine type 2 receptors, and 5-HT<sub>3</sub> receptors. An example of nausea that is most likely mediated by the cortex is anticipatory nausea before a dose of chemotherapy or other noxious stimuli.

Specific causes of nausea include metabolic changes (liver failure, uremia from renal failure, hypercalcemia), bowel obstruction, constipation, infection, GERD, vestibular disease, brain metastases, medications (including antibiotics, NSAIDs, proton-pump inhibitors, opioids, chemotherapy), and radiation therapy. Anxiety can also contribute to nausea.

#### Intervention

Medical treatment of nausea is directed at the anatomic and receptor-mediated cause that a careful history and

physical examination reveals. When a single specific cause is not found, many advocate beginning treatment with dopamine antagonists such as haloperidol or prochlorperazine. Prochlorperazine is usually more sedating than haloperidol. When decreased motility is suspected, metoclopramide can be an effective treatment. When inflammation of the GI tract is suspected, glucocorticoids such as dexamethasone are an appropriate treatment. For postchemotherapy and -radiation therapy nausea, one of the 5-HT<sub>3</sub> receptor antagonists (ondansetron, granisetron, dolasetron) is recommended. When a vestibular cause (such as “motion sickness” or labyrinthitis) is suspected, antihistamines such as meclizine (whose primary side effect is drowsiness) or anticholinergics such as scopolamine can be effective. In anticipatory nausea, a benzodiazepine such as lorazepam is indicated. As with antihistamines, drowsiness and confusion are the main side effects.

### Dyspnea

#### Frequency

Dyspnea is a subjective experience of being short of breath. Nearly 75% of dying patients experience dyspnea at some point in their illness. Dyspnea is among the most distressing of physical symptoms and can be even more distressing than pain.

#### Assessment

As with pain, dyspnea is a subjective experience that may not correlate with objective measures of PO<sub>2</sub>, PCO<sub>2</sub>, or respiratory rate. Consequently, measurements of oxygen



408 saturation through pulse oximetry or blood gases are rarely helpful in guiding therapy. Potentially reversible or treatable causes of dyspnea include infection, pleural effusions, pulmonary emboli, pulmonary edema, asthma, or tumor encroachment on the airway. However, the risk-benefit ratio of the diagnostic and therapeutic interventions for patients with little time left to live must be carefully considered before undertaking diagnostic steps. Frequently, the specific etiology cannot be identified, and dyspnea is the consequence of progression of the underlying disease that cannot be treated. The anxiety caused by dyspnea and the choking sensation can significantly exacerbate the underlying dyspnea in a negatively reinforcing cycle.

### Interventions

When reversible or treatable etiologies are diagnosed, they should be treated as long as the side effects of treatment, such as repeated drainage of effusions or anticoagulants, are less burdensome than the dyspnea itself. More aggressive treatments, such as stenting a bronchial lesion, may be warranted if it is clear that the dyspnea is due to tumor invasion at that site and if the patient and family understand the risks of such a procedure. Usually, treatment is symptomatic (Table 30-6). Low-dose opioids reduce the sensitivity of the central respiratory center and the sensation of dyspnea. If patients are not receiving opioids, weak opioids can be initiated; if patients are already receiving opioids, then morphine or other strong opioids should be used. Controlled trials do not support the use of nebulized opioids for dyspnea at the end of life. Phenothiazines and chlorpromazine may be helpful when combined with opioids. Benzodiazepines can be helpful if anxiety is present but should be neither first-line therapy nor used alone in the treatment of dyspnea. If the patient has a history of COPD or

asthma, inhaled bronchodilators and glucocorticoids may also be helpful. If the patient has pulmonary edema due to heart failure, diuresis with a medication such as furosemide is indicated. Excess secretions can be dried with scopolamine, transdermally or intravenously. Oxygen can be used, although it may only be an expensive placebo. For some families and patients, oxygen is distressing; for some it is reassuring. More general interventions that medical staff can do include sitting the patient upright, removing smoke or other irritants such as perfume, ensuring a supply of fresh air with sufficient humidity, and minimizing other factors that can increase anxiety.

### Fatigue

#### Frequency

More than 90% of terminally ill patients experience fatigue and/or weakness. Fatigue is frequently cited as among the most distressing of symptoms.

#### Etiology

The multiple causes of fatigue in the terminally ill can be categorized as resulting from the underlying disease; from disease-induced factors, such as tumor necrosis factor and other cytokines; and from secondary factors such as dehydration, anemia, infection, hypothyroidism, and drug side effects. Apart from low caloric intake, loss of muscle mass and changes in muscle enzymes may play an important role in the fatigue of terminal illness. The importance of changes in the CNS, especially the reticular activating system, have been hypothesized based on reports of fatigue in patients receiving cranial radiation, experiencing depression, or with chronic pain in the absence of cachexia or other physiologic changes. Finally, depression and other causes of psychological distress can contribute to fatigue.

TABLE 30-6

#### MEDICATIONS FOR THE MANAGEMENT OF DYSPNEA

INTERVENTION	DOSE	COMMENTS
Weak opioids		For patients with mild dyspnea
Codeine (or codeine with 325 mg acetaminophen)	30 mg PO q4h	For opioid-naive patient
Hydrocodone	5 mg PO q4h	
Strong opioids		For opioid-naive patients with moderate to severe dyspnea
Morphine	5–10 mg PO q4h	
	30–50% of baseline opioid dose q4h	For patients already taking opioids for pain or other symptoms
Oxycodone	5–10 mg PO q4h	
Hydromorphone	1–2 mg PO q4h	
Anxiolytics		Give a dose every hour until the patient is relaxed, then provide a dose for maintenance
Lorazepam	0.5–2.0 mg PO/SL/IV qh then q4–6h	
Clonazepam	0.25–2.0 mg PO q12h	
Midazolam	0.5 mg IV q15min	

### Assessment

Fatigue is subjective; objective changes, even in body mass, may be absent. Consequently, assessment must rely on patient self-reporting. Scales used to measure fatigue, such as the Edmonton Functional Assessment Tool, the Fatigue Self-Report scales, or the Rhoten Fatigue scale, are usually appropriate for research rather than clinical purposes. In clinical practice, a simple performance assessment such as the Karnofsky Performance Status or the Eastern Cooperative Oncology Group's question "How much of the day does the patient spend in bed?" may be the best measure. In this 0–4 performance status assessment, a 0 = normal activity; 1 = symptomatic without being bedridden; 2 = requiring some, but <50%, bed time; 3 = bedbound more than half the day; and 4 = bedbound all the time. Such a scale allows for assessment over time and correlates with overall disease severity and prognosis.

### Interventions

At the end of life, fatigue will not be "cured." The goal is to ameliorate it and help patients and families to adjust expectations. Behavioral interventions should be used to avoid blaming the patient for inactivity and to educate both the family and patient that the underlying disease causes physiologic changes producing low energy levels. Understanding that the problem is physiologic not psychological can help to alter expectations regarding the patient's level of physical activity. Practically, this may mean reducing routine activities, such as housework and cooking, or social events outside the house, and making it acceptable to receive guests lying on a couch. At the same time, institution of exercise regimens and physical therapy can raise endorphins, reduce muscle wasting, and reduce the risk of depression. In addition, ensuring good hydration without worsening edema may help reduce fatigue. Discontinuing medications that worsen fatigue may help, including cardiac medications, benzodiazepines, certain antidepressants or opioids, if pain is well controlled.

Only a few pharmacologic interventions target fatigue and weakness. Glucocorticoids can increase energy and enhance mood. Dexamethasone is preferred for its once-a-day dosing and minimal mineralocorticoid activity. Benefit, if any, is usually seen within the first month. Psychostimulants, such as dextroamphetamine (5–10 mg PO) and methylphenidate (2.5–5 mg PO), may also enhance energy levels, although a randomized trial did not show methylphenidate beneficial compared to placebo in cancer fatigue. Dosages should be given in the morning and at noon to minimize the risk of counterproductive insomnia. Modafinil, developed for narcolepsy, has shown some promise in the treatment of fatigue and has the advantage of once-daily dosing. Its precise role in the fatigue at the end of life is yet to be determined. Anecdotal evidence suggests that

L-carnitine might improve fatigue, depression, and sleep disruption.

## PSYCHOLOGICAL SYMPTOMS AND THEIR MANAGEMENT

### Depression

#### Frequency

Depression at the end of life presents an apparently paradoxical situation. Many people believe that depression is normal among seriously ill patients because they are dying. People frequently say, "Wouldn't you be depressed?" However, depression is not a necessary part of terminal illness and can contribute to needless suffering. Although sadness, anxiety, anger, and irritability are normal responses to a serious condition, they are typically of modest intensity and transient. Persistent sadness and anxiety and the physically disabling symptoms that these can lead to are abnormal and suggestive of major depression. Although as many as 75% of terminally ill patients experience depressive symptoms, <25% of terminally ill patients have major depression.

#### Etiology

Previous history of depression, family history of depression or bipolar disorder, and prior suicide attempts are associated with increased risk for depression among terminally ill patients. Other symptoms, such as pain and fatigue, are associated with higher rates of depression; uncontrolled pain can exacerbate depression, and depression can cause patients to be more distressed by pain. Many medications used in the terminal stages, including glucocorticoids, and some anticancer agents, such as tamoxifen, interleukin 2, interferon  $\alpha$ , and vincristine, are also associated with depression. Some terminal conditions, such as pancreatic cancer, certain strokes, and heart failure have been reported to be associated with higher rates of depression, although this is controversial. Finally, depression may be attributable to grief over the loss of a role or function, social isolation, or loneliness.

#### Assessment

Diagnosing depression among seriously ill patients is complicated because many of the vegetative symptoms in the DSM-IV criteria for clinical depression—insomnia, anorexia and weight loss, fatigue, decreased libido, and difficulty concentrating—are associated with the dying process itself. The assessment of depression in seriously ill patients should therefore focus on the dysphoric mood, helplessness, hopelessness, and lack of interest and enjoyment and concentration in normal activities. The single questions "How often do you feel downhearted and blue?" (more than a good bit of the time or similar responses) or "Do you feel depressed most of the time?" are appropriate for screening.

Certain conditions may be confused with depression. Endocrinopathies, such as hypothyroidism or Cushing's syndrome, electrolyte abnormalities such as hypercalcemia, and akathisia, especially from dopamine-blocking antiemetics such as metoclopramide and prochlorperazine, can mimic depression and should be excluded.

### Interventions

Physicians must treat any physical symptom, such as pain, that may be causing or exacerbating depression. Fostering adaptation to the many losses that the patient is experiencing can also be helpful. Nonpharmacologic interventions, including group or individual psychological counseling, and behavioral therapies, such as relaxation or imagery, can be helpful, especially in combination with drug therapy.

Pharmacologic interventions remain the core of therapy. The same medications are used to treat depression in terminally ill as in non-terminally ill patients. Psychostimulants may be preferred for patients with a poor prognosis or for those with fatigue or opioid-induced somnolence. Psychostimulants are comparatively fast acting, working within a few days, instead of the weeks required for selective serotonin reuptake inhibitors (SSRIs). Dextroamphetamine or methylphenidate should be started at 2.5–5.0 mg in the morning and at noon, the same starting dosages used for treating fatigue. The dose can be escalated up to 15 mg bid. Modafinil is started at 100 mg qd and can be increased to 200 mg if there is no effect at the lower dose. Pemoline is a non-amphetamine psychostimulant with minimal abuse potential. It is also effective as an antidepressant beginning at 18.75 mg in the morning and at noon. Because it can be absorbed through the buccal mucosa, it is preferred for patients with intestinal obstruction or dysphagia. If used for prolonged periods, liver function must be monitored. The psychostimulants can also be combined with more traditional antidepressants while waiting for the latter to become effective and then tapered after a few weeks if necessary. Psychostimulants have side effects, particularly initial anxiety, insomnia, and rarely paranoia, which may necessitate lowering the dose or discontinuing treatment.

Mirtazapine, an antagonist at the postsynaptic serotonin receptors, is a promising psychostimulant. It should be started at 7.5 mg before bed. It has sedating, antiemetic, and anxiolytic properties with few drug interactions. Its side effect of weight gain may also be beneficial for seriously ill patients; it is available in orally disintegrating tablets.

For patients with a prognosis of several months or longer, SSRIs, including fluoxetine, sertraline, paroxetine and citalopram, and serotonin-noradrenaline reuptake inhibitors, such as venlafaxine, are the preferred treatment because of their efficacy and comparatively few side effects. Because low doses of these medications may

be effective for seriously ill patients, use half the usual starting dose for healthy adults. The starting dose for fluoxetine is 10 mg once a day. In most cases, once-a-day dosing is possible. The choice of which SSRI to use should be driven by (1) the patient's past success or failure with the specific medication, and (2) the most favorable side effect profile for that specific agent. For instance, for a patient in whom fatigue is a major symptom, a more activating SSRI (fluoxetine) would be appropriate. For a patient in whom anxiety and sleeplessness are major symptoms, a more sedating SSRI (paroxetine) would be appropriate.

Atypical antidepressants are recommended only in selected circumstances, usually with the assistance of a specialty consultation. Trazodone can be an effective antidepressant but is sedating and can cause orthostatic hypotension and, rarely, priapism. Therefore, it should be used only when a sedating effect is desired and is often used for patients with insomnia, at a dose starting at 25 mg. In addition to its antidepressant effects, bupropion is energizing, making it useful for depressed patients suffering from fatigue. However, it can cause seizures, preventing its use for patients with a risk of CNS neoplasms or terminal delirium. Finally, alprazolam, a benzodiazepine, starting at 0.25–1.0 mg tid, can be effective in seriously ill patients suffering from a combination of anxiety and depression. Although it is potent and works quickly, it has many drug interactions and may cause delirium, especially among very ill patients, because of its strong binding to the benzodiazepine–GABA receptor complex.

Unless used as adjuvants for the treatment of pain, tricyclic antidepressants are not recommended. Similarly, the monoamine oxidase (MAO) inhibitors are not recommended because of their side effects and dangerous drug interactions.

## Delirium

### Frequency

In the weeks or months before death, delirium is uncommon, although it may be significantly underdiagnosed. However, delirium becomes relatively common in the hours and days immediately before death. Up to 85% of patients dying from cancer may experience terminal delirium.

### Etiology

Delirium is a global cerebral dysfunction characterized by alterations in cognition and consciousness. It is frequently preceded by anxiety, changes in sleep patterns (especially reversal of day and night), and decreased attention. In contrast to dementia, delirium has an acute onset, fluctuating consciousness and inattention, and is reversible, although reversibility may be more theoretical than real for patients near death. Delirium may occur in

a patient with dementia; indeed, patients with dementia are more vulnerable to delirium.

Causes of delirium include metabolic encephalopathy arising from liver or renal failure, hypoxemia, or infection; electrolyte imbalances such as hypercalcemia; paraneoplastic syndromes; dehydration; and primary brain tumors, brain metastases, or leptomeningeal spread of tumor. Commonly, among dying patients, delirium can be caused by side effects of treatments, including radiation for brain metastases, and medications, including opioids, glucocorticoids, anticholinergic drugs, antihistamines, antiemetics, benzodiazepines, and chemotherapeutic agents. The etiology may be multifactorial; e.g., dehydration may exacerbate opioid-induced delirium.

### Assessment

Delirium should be recognized in any terminally ill patient with new onset of disorientation, impaired cognition, somnolence, fluctuating levels of consciousness, or delusions with or without agitation. Delirium must be distinguished from acute anxiety and depression, as well as dementia. The central distinguishing feature is altered consciousness, which is not usually noted in anxiety, depression, and dementia. Although “hyperactive” delirium characterized by overt confusion and agitation is likely more common, patients should also be assessed for “hypoactive” delirium characterized by sleep-wake reversal and decreased alertness.

In some cases, use of formal assessment tools such as the Mini-Mental Status Examination (which does not distinguish delirium from dementia) or the Delirium Rating Scale (which does distinguish delirium from dementia) may be helpful in distinguishing delirium from other processes. The patient’s list of medications must be carefully evaluated. Nonetheless, a reversible etiologic factor for delirium is found in fewer than half of terminally ill patients. Because most terminally ill patients experiencing delirium will be very close to death and may be at home, extensive diagnostic evaluations, such as lumbar punctures or neuroradiologic examinations, are usually inappropriate.

### Interventions

One of the most important objectives of terminal care is to provide terminally ill patients the lucidity to say goodbye to the people they love. Delirium, especially with agitation during the final days, is distressing to family and caregivers. A strong determinant of bereavement difficulties is witnessing a difficult death. Thus terminal delirium should be treated aggressively.

At the first sign of delirium, such as day-night reversal with slight changes in mentation, let the family know that it is time to be sure that everything they want to have said has been said. The family should be informed that delirium is common just before death.

**TABLE 30-7**

### MEDICATIONS FOR THE MANAGEMENT OF DELIRIUM

INTERVENTIONS	DOSE
<b>Neuroleptics</b>	
Haloperidol	0.5–5 mg q2–12h, PO/IV/SC/IM
Thioridazine	10–75 mg q4–8h, PO
Chlorpromazine	12.5–50 mg q4–12h, PO/IV/IM
<b>Atypical neuroleptics</b>	
Olanzapine	2.5–5 mg qd or bid, PO
Risperidone	1–3 mg q12h, PO
<b>Anxiolytics</b>	
Lorazepam	0.5–2 mg q1–4h, PO/IV/IM
Midazolam	1–5 mg/h continuous infusion, IV/SC
<b>Anesthetics</b>	
Propofol	0.3–2.0 mg/h continuous infusion, IV

If medications are suspected of being a cause of the delirium, then unnecessary agents should be discontinued. Other potentially reversible causes such as constipation, urinary retention, and metabolic abnormalities should be treated. Supportive measures aimed at providing a familiar environment should be instituted, including restricting visits only to individuals with whom the patient is familiar and eliminating new experiences; orienting the patient, if possible, by providing a clock and calendar; and gently correcting the patient’s hallucinations or cognitive mistakes.

Pharmacologic management focuses on the use of neuroleptics and, in the extreme, anesthetics (Table 30-7). Haloperidol remains first-line therapy. Usually, patients can be controlled with a low dose (1–3 mg/d), usually given every 6 h, although some may require as much as 20 mg/d. It can be administered PO, SC, or IV. IM injections should not be used, except when it is the only way to get a patient under control. Olanzapine, an atypical neuroleptic, has shown significant effectiveness in completely resolving delirium in cancer patients. It has other beneficial effects for terminally ill patients, including antinausea, antianxiety, and weight gain. It is useful for patients with longer anticipated life expectancy because it is less likely to cause dysphoria and has a lower risk of dystonic reactions. Also, because it is metabolized through multiple pathways, it can be used in patients with hepatic and renal dysfunction. Olanzapine has the disadvantage that it is only available orally and that it takes a week to reach steady state. The usual dose is 2.5–5 mg PO bid. Chlorpromazine (10–25 mg every 4–6 h) can be useful if sedation is desired and can be administered IV or PR in addition to PO. Dystonic reactions resulting from dopamine blockade are a side effect of neuroleptics, although they are reported to be rare when used to treat terminal delirium. If patients develop dystonic reactions, benztropine should be administered.

412 Neuroleptics may be combined with lorazepam to reduce agitation when the delirium is the result of alcohol or sedative withdrawal.

If no response to first-line therapy is seen, a specialty consultation should be obtained with a change to a different medication. If patients fail to improve after a second neuroleptic, then sedation with an anesthetic such as propofol or continuous-infusion midazolam may be necessary. By some estimates, at the very end of life as many as 25% of patients experiencing delirium, especially restless delirium with myoclonus or convulsions, may require sedation.

Physical restraints should be used with great reluctance only when the patient's violence is threatening to self or others. If used, their appropriateness should be reevaluated frequently.

## Insomnia

### Frequency

Sleep disorders, defined as either difficulty initiating sleep or maintaining sleep, sleep difficulty at least 3 nights a week or sleep difficulty that causes impairment of daytime functioning, occurs in between 19% and 63% of patients with advanced cancer.

### Etiology

Patients with cancer may have changes in sleep efficiency such as an increase in stage I sleep. Other etiologies of insomnia are coexisting physical illness, such as thyroid disease, or coexisting psychological illnesses, such as depression and anxiety. Medications, including antidepressants, psychostimulants, steroids, and  $\beta$  agonists, are significant contributors to sleep disorders, as are caffeine and alcohol. Multiple over-the-counter medications contain caffeine and antihistamines, which can contribute to sleep disorders.

### Assessment

Assessment should include specific questions concerning sleep onset, sleep maintenance, and early morning waking because these will provide clues to the causative agents and to management. Patients should be asked about previous sleep problems, screened for depression and anxiety, and asked about symptoms of thyroid disease. Caffeine and alcohol are prominent causes of sleep problems, and a careful history of these substances should be obtained. Both excessive use and withdrawal from alcohol can be causes of sleep problems.

### Interventions

The mainstays of intervention include improvement of sleep hygiene (encouraging regular time for sleep, decreased nighttime distractions, elimination of caffeine and other stimulants and alcohol), intervention to treat anxiety and depression, and finally treatment for the

insomnia itself. For patients with depression who have insomnia and anxiety, a sedating antidepressant such as mirtazapine can be helpful. In the elderly, trazodone, beginning at 25 mg at nighttime, is an effective sleep aid at doses lower than its antidepressant effect. Zolpidem may have a decreased incidence of delirium in patients compared with traditional benzodiazepines, but this has not been clearly established. When benzodiazepines are prescribed, short-acting ones (such as lorazepam) are favored over longer-acting (such as diazepam). Patients who receive these medications should be observed for signs of increased confusion and delirium.

## SOCIAL NEEDS AND THEIR MANAGEMENT

### Financial Burdens

#### Frequency

Dying can impose substantial economic strains on patients and families, causing distress. In the United States, with one of the least comprehensive health insurance systems among the developed countries, ~20% of terminally ill patients and their families spend >10% of family income on health care costs over and above health insurance premiums. Between 10% and 30% of families sell assets, use savings, or take out a mortgage to pay for the patient's health care costs. Nearly 40% of terminally ill patients in the United States report that the cost of their illness is a moderate or great economic hardship for their family.

The patient is likely to reduce and stop working. In 20% of cases, a family member of the terminally ill patient also stops working to provide care. The major underlying causes of economic burden are related to poor physical functioning and care needs, such as the need for housekeeping, nursing, and personal care. More debilitated patients and poor patients experience greater economic burdens.

#### Intervention

This economic burden should not be ignored as a private matter. It has been associated with a number of adverse health outcomes, including preferring comfort care over life-prolonging care as well as consideration of euthanasia or physician-assisted suicide. Economic burdens increase the psychological distress of families and caregivers of terminally ill patients, and poverty is associated with many adverse health outcomes. Assistance from a social worker, early on if possible, to ensure access to all available benefits may be helpful. Many patients, families, and health care providers are unaware of options for long-term care insurance, respite care, the Family Medical Leave Act (FMLA), and other sources of assistance. Some of these options (such as respite care) may be part of a formal hospice program but others (such as the FMLA) do not require enrollment in a hospice program.

## Relationships

### Frequency

Settling personal issues and closing the narrative of lived relationships are universal needs. When asked if sudden death or death after an illness is preferable, respondents often initially select the former but soon change to the latter as they reflect on the importance of saying goodbye. Bereaved family members who have not had the chance to say goodbye often have a more difficult grief process.

### Interventions

Care of seriously ill patients requires efforts to facilitate the types of encounters and time spent with family and friends that are necessary to meet these needs. Family and close friends may need to be accommodated with unrestricted visiting hours, which may include sleeping near the patient even in otherwise regimented institutional settings. Physicians and other health care providers may be able to facilitate and resolve strained interactions between the patient and other family members. Assistance for patients and family members who are unsure about how to create or help preserve memories, whether by providing materials such as a scrapbook or memory box or by offering them suggestions and informational resources, can be deeply appreciated. Taking photographs and creating videos can be especially helpful to terminally ill patients who have younger children or grandchildren.

## Family Caregivers

### Frequency

Caring for seriously ill patients places a heavy burden on families. Families are frequently required to provide transportation and homemaking as well as other services. Typically, paid professionals such as home health nurses and hospice workers supplement family care; only about a quarter of all caregiving is exclusively paid professional assistance. The trend toward more out-of-hospital deaths will increase reliance on families for end-of-life care. Increasingly, family members are being called on to provide physical care (such as moving and bathing patients) and medical care (such as assessing symptoms and giving medications) in addition to emotional care and support.

Three-quarters of family caregivers of terminally ill patients are women—wives, daughters, and even sisters. Because many are widowed, women themselves tend to be able to rely less on family for caregiving assistance and may need more paid assistance. About 20% of terminally ill patients report substantial unmet needs for nursing and personal care. The impact of caregiving on family caregivers is substantial: both bereaved and current caregivers have a higher mortality compared to non-caregiving controls.

### Interventions

It is imperative to inquire about unmet needs and to try to ensure those needs are met either through the family or paid professional services when possible. Community assistance through houses of worship or other community groups can often be mobilized by one or two phone calls from the medical team to someone the patient or family identifies. Sources of support specifically for family caregivers should be identified through local sources or nationally through groups such as the National Family Caregivers Association ([www.nfcares.org](http://www.nfcares.org)), the American Cancer Society ([www.cancer.org](http://www.cancer.org)), and the Alzheimer's Association ([www.alz.org](http://www.alz.org)).

## EXISTENTIAL NEEDS AND THEIR MANAGEMENT

### Frequency

Religion and spirituality are often important to dying patients. Nearly 70% of patients report becoming more religious or spiritual when they became terminally ill, and many find comfort in various religious or spiritual practices such as prayer. However, ~20% of terminally ill patients become less religious, frequently feeling cheated or betrayed by becoming terminally ill. For other patients, the need is for existential meaning and purpose that is distinct from and may even be antithetical to religion or spirituality. When asked, patients and family caregivers frequently report wanting their professional caregivers to be more attentive to religion and spirituality.

### Assessment

Health care providers are often hesitant about involving themselves in the religious, spiritual, and existential experiences of their patients because it may seem private or not relevant to the current illness. But physicians and other members of the care team should be able to at least detect spiritual and existential needs. Screening questions have been developed for a physician's spiritual history taking. Spiritual distress can amplify other types of suffering and even masquerade as intractable physical pain, anxiety, or depression. The screening questions in the comprehensive assessment are usually sufficient. Deeper evaluation and intervention are rarely appropriate for the physician unless no other member of a care team is available or suitable. Pastoral care providers may be helpful, whether from the medical institution or the patient's own community.

### Interventions

Precisely how religious practices, spirituality, and existential explorations can be facilitated and improve end-of-life care is not well established. What is clear is that for physicians, one main intervention is to inquire about the role and importance of spirituality and religion in a patient's life. This will help a patient

414 feel heard and help physicians to identify specific needs. In one study, only 36% of respondents indicated that a clergy member would be comforting. Nevertheless, the increase in religious and spiritual interest among a substantial fraction of dying patients suggests inquiring of individual patients how this need can be addressed.

## MANAGING THE LAST STAGES

### WITHDRAWING AND WITHHOLDING LIFE-SUSTAINING TREATMENT

#### Legal Aspects

For centuries, it has been deemed ethical to withhold or withdraw life-sustaining interventions. The current legal consensus is that patients have a constitutional and common law right to refuse medical interventions. Courts have also held that incompetent patients have a right to refuse medical interventions. For patients who are incompetent and terminally ill and who have not completed an advance care directive, next of kin can exercise this right, although this may be restricted in some states depending how clear and convincing the evidence is of the patient's preferences. Courts have limited families' ability to terminate life-sustaining treatments from patients who are conscious, incompetent, but not terminally ill. In theory, patients' right to refuse medical therapy can be limited by four countervailing interests: (1) preservation of life, (2) prevention of suicide, (3) protection of third parties such as children, and (4) preserving the integrity of the medical profession. In practice, these interests almost never override the right of competent patients and incompetent patients who have left explicit and advance care directives.

Regarding incompetent patients who either appointed a proxy without specific indications of their wishes or who never completed an advance care directive, three criteria have been suggested to guide the decision to terminate medical interventions. First, some commentators suggest that ordinary care should be administered but extraordinary care could be terminated. Because the ordinary/extraordinary distinction is too vague, courts and commentators widely agree that it should not be used to justify decisions about stopping treatment. Second, many courts have advocated use of the substituted-judgment criterion, which holds that the proxy decision makers should try to imagine what the incompetent patient would do if he or she were competent. However, multiple studies indicate that many proxies, even close family members, cannot accurately predict what the patient would have wanted. Therefore, substituted judgment becomes more of a guessing game than a way of fulfilling the patient's wishes. Finally, the best-interests criterion holds that proxies should evaluate treatments by balancing their

benefits and risks and select those treatments in which the benefits maximally outweigh the burdens of treatment. Clinicians have a clear and crucial role in this by carefully and dispassionately explaining the known benefits and burdens of specific treatments. Yet, even when information is as clear as possible, different individuals can have very different views of what is in the patient's best interests, and families may have disagreements or even overt conflicts. This criterion has been criticized because no single way exists of determining the balance between benefits and burdens; it depends on a patient's personal values. As a matter of practice, physicians rely on family members to make decisions that they feel are best and object only if these decisions seem to demand treatments that the physicians consider not beneficial.

#### Practices

Withholding and withdrawing acutely life-sustaining medical interventions from terminally ill patients are now standard practice. More than 90% of American patients die without cardiopulmonary resuscitation (CPR), and just as many forgo other potentially life-sustaining interventions. For instance, during 1987–1988 in ICUs, CPR was performed 49% of the time, but only 10% of the time in 1992–1993. On average, 3.8 interventions, such as vasopressors and transfusions, were stopped for each dying ICU patient. However, practices vary widely among hospitals and ICUs, suggesting an important element of physician preferences rather than objective data.

Mechanical ventilation may be the most challenging intervention to withdraw. The two approaches are *terminal extubation*, which is the removal of the endotracheal tube, and *terminal weaning*, which is the gradual reduction of the  $FI_{O_2}$  or ventilator rate. A third of ICU physicians prefer to use the terminal wean technique, whereas 13% extubate; most physicians use both techniques. Some recommend terminal weaning because patients do not develop upper airway obstruction and the distress caused by secretions or stridor; however, terminal weaning can also prolong the dying process and not allow a patient's family to be with him or her unencumbered by an endotracheal tube. To ensure comfort for conscious or semiconscious patients before withdrawal of the ventilator, neuromuscular blocking agents should be terminated and sedatives and analgesics administered. Removing the neuromuscular blocking agents permits patients to show discomfort, facilitating the titration of sedatives and analgesics; it also permits interactions between patients and their families. A common practice is to inject a bolus of midazolam (2–4 mg) or lorazepam (2–4 mg) before withdrawal, followed by 5–10 mg of morphine and continuous infusion of morphine (50% of the bolus dose per hour) during weaning. In patients who have

significant upper airway secretions, IV scopolamine at a rate of 100 µg/h can be administered. Additional boluses of morphine or increases in the infusion rate should be administered for respiratory distress or signs of pain. Higher doses will be needed for patients already receiving sedatives and opioids. Families need to be reassured about treatments for common symptoms after withdrawal of ventilatory support such as dyspnea or agitation and warned about the uncertainty of length of survival after withdrawal of ventilatory support: up to 10% of patients unexpectedly survive for 1 day or more after mechanical ventilation is stopped.

## FUTILE CARE

Beginning in the late 1980s, some commentators argued that physicians could terminate futile treatments demanded by families of terminally ill patients. Although no objective definition or standard of futility exists, several categories have been proposed. Physiologic futility means that an intervention will have no physiologic effect. Some have defined qualitative futility as those that “fail to end a patient’s total dependence on intensive medical care.” Quantitative futility occurs “when physicians conclude (either through personal experience, experiences shared with colleagues, or consideration of reported empirical data) that in the last 100 cases, a medical treatment has been useless.” The term conceals subjective value judgments about when a treatment is “not beneficial.” Deciding whether a treatment that obtains an additional 6 weeks of life or a 1% survival advantage confers benefit depends on patients’ preferences and goals. Furthermore, physicians’ predictions of when treatments were futile deviated markedly from the quantitative definition. When residents thought CPR was quantitatively futile, more than one in five patients had a >10% chance of survival to hospital discharge.

Quantitative futility rarely applies in ICU settings. Many commentators reject using futility as a criterion of withdrawing care, preferring instead to consider futility situations as ones that represent conflict that can benefit from careful negotiation between families and health care providers.

Some hospitals have enacted “unilateral DNR” policies to allow clinicians to provide a do-not-resuscitate order in cases where consensus cannot be reached with families and medical opinion is that resuscitation would be futile if attempted. This type of a policy is not a replacement for careful and patient communication and negotiation, but it recognizes that agreement cannot always be reached. Texas, Virginia, Maryland, and California and have enacted so-called medical futility laws that provide physicians a “safe harbor” from liability if they terminate life-sustaining treatments over the wishes of the patient’s family. For instance, in Texas when a disagreement about terminating interventions between the medical team and family has not been resolved by an ethics consultation, then the hospital is supposed to try to facilitate transfer of the patient to another institution willing to provide treatment. If this fails after 10 days, then the hospital and physician may unilaterally withdraw treatments determined to be futile. The family may appeal to a state court. Early data suggest the law increases futility consultations for the ethics committee and that although most families concur with withdrawal, about 10–15% of families refuse to withdraw treatment. Approximately 12 cases have gone to court in Texas in 7 years after adoption of the law.

## EUTHANASIA AND PHYSICIAN-ASSISTED SUICIDE

Euthanasia and physician-assisted suicide are defined in [Table 30-8](#). Terminating life-sustaining care and

**TABLE 30-8**

### DEFINITIONS OF ASSISTED SUICIDE AND EUTHANASIA

TERM	DEFINITION	LEGAL STATUS
Voluntary active euthanasia	Intentionally administering medications or other interventions to cause the patient’s death with the patient’s informed consent	Netherlands Belgium
Involuntary active euthanasia	Intentionally administering medications or other interventions to cause the patient’s death when the patient was competent to consent but did not—e.g., the patient may not have been asked	Nowhere
Passive euthanasia	Withholding or withdrawing life-sustaining medical treatments from a patient to let him or her die (terminating life-sustaining treatments)	Everywhere
Physician-assisted suicide	A physician provides medications or other interventions to a patient with the understanding that the patient can use them to commit suicide	Oregon Netherlands Belgium Switzerland



416 providing opioid medications to manage symptoms have long been considered ethical by the medical profession and legal by courts and should not be confused with euthanasia or physician-assisted suicide.

### Legal Aspects

Euthanasia is legal in the Netherlands and Belgium. Euthanasia was legalized in the Northern Territory of Australia but then repealed. Euthanasia is not legal in any state in the United States. Physician-assisted suicide is legal in Oregon but only if multiple criteria are met and then only after a process that includes a 15-day waiting period. In Switzerland, a layperson can legally assist suicide. In all other countries and all other states in the United States, physician-assisted suicide and euthanasia are illegal explicitly or by common law.

### Practices

Fewer than 10–20% of terminally ill patients actually consider euthanasia and/or physician-assisted suicide for themselves. In the Netherlands and Oregon, >70% of patients using these interventions are dying of cancer; <5% of deaths by euthanasia or physician-assisted suicide involve patients with AIDS or amyotrophic lateral sclerosis. In the Netherlands, if all legal and illegal acts are grouped, euthanasia and physician-assisted suicide account for 3.5% of all deaths. In Oregon, ~0.1% of patients die by physician-assisted suicide, although this may be an underestimate.

Pain is not a primary motivator for patients' requests for or interest in euthanasia and/or physician-assisted suicide. Among the first patients to receive physician-assisted suicide in Oregon, only 1 patient of 15 had inadequate pain control compared to 15 of 43 patients in a control group experiencing inadequate pain relief. Depression, hopelessness, and, more profoundly, concerns about loss of dignity or autonomy or being a burden on family members appear to be primary factors motivating a desire for euthanasia or physician-assisted suicide. A study from the Netherlands showed that depressed terminally ill cancer patients were four times more likely to request euthanasia, and it confirmed that uncontrolled pain was not associated with greater interest in euthanasia.

Euthanasia and physician-assisted suicide are no guarantee of a painless, quick death. Data from the Netherlands indicate that in as many as 20% of cases technical and other problems arose, including patients waking from coma, not becoming comatose, regurgitating medications, and a prolonged time to death. Problems were significantly more common in physician-assisted suicide, sometimes requiring the physician to intervene and provide euthanasia.

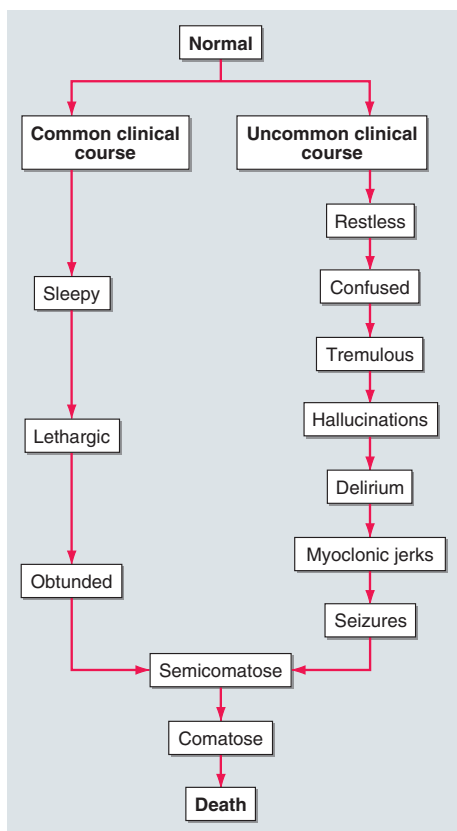
Whether practicing in a setting where euthanasia is legal or not, over a career, between 12% and 54% of

physicians will receive a request for euthanasia or physician-assisted suicide from a patient. Competency in dealing with such a request is crucial. Although challenging, such a request can also be a chance to address intense suffering. After receiving a request for euthanasia and/or physician-assisted suicide, health care providers should carefully clarify the request with empathic, open-ended questions to help elucidate the underlying cause for the request such as "What makes you want to consider this option?" Endorsing either moral opposition or moral support for the act tends to be counterproductive, either lending an impression of being judgmental or endorsing the idea that the patient's life is worthless. Health care providers must reassure the patient of continued care and commitment. The patient should be educated about alternative, less controversial options, such as symptom management and withdrawing any unwanted treatments; the reality of euthanasia and/or physician-assisted suicide because the patient may have misconceptions about their effectiveness; and also the legal implications of the choice. Depression, hopelessness, and other symptoms of psychological distress as well as physical suffering and economic burdens are likely factors motivating the request, and such factors should be assessed and treated aggressively. After these interventions and clarification of options, most patients proceed with another approach, declining life-sustaining interventions, possibly including refusal of nutrition and hydration.

## CARE DURING THE LAST HOURS

Most laypersons have limited experiences with the actual dying process and death. They frequently do not know what to expect of the final hours, and afterward. The family and other caregivers must be prepared, especially if the plan is for the patient to die at home.

Patients in the last days of life typically experience extreme weakness and fatigue and become bedbound, which can lead to pressure sores. The issue of turning patients who are near the end of life, however, must be balanced against the potential discomfort that movement may cause. Patients stop eating and drinking with drying of mucosal membranes and dysphagia. Careful attention to oral swabbing, lubricants for lips, and use of artificial tears can provide a form of care to substitute for attempts at feeding the patient. With loss of the gag reflex and dysphagia, patients may also experience accumulation of oral secretions, producing noises during respiration sometimes called "the death rattle." Scopolamine can reduce the secretions. Patients also experience changes in respiration with periods of apnea or Cheyne-Stokes breathing. Decreased intravascular volume and cardiac output cause tachycardia, hypotension, peripheral coolness, and livedo reticularis (skin



**FIGURE 30-2**

**Common and uncommon clinical courses in the last days of terminally ill patients.** (Adapted from FD Ferris et al: *Module 4: Palliative care, in Comprehensive Guide for the Care of Persons with HIV Disease*. Toronto: Mt. Sinai Hospital and Casey Hospice, 1995, at [www.cpsonline.info/content/resources/hivmodule4.html](http://www.cpsonline.info/content/resources/hivmodule4.html).)

mottling). Patients can have urinary and, less frequently, fecal incontinence. Changes in consciousness and neurologic function generally lead to two different paths to death (Fig. 30-2).

Each of these terminal changes can cause patients and families distress, requiring reassurance and targeted interventions (Table 30-9). Informing families that these changes might occur, and even providing them an information sheet, can help to preempt problems and minimize distress. Understanding that patients stop eating because they are dying, not dying because they have stopped eating, can reduce family and caregiver anxiety. Similarly, informing the family and caregivers that the “death rattle” may occur and that it is not indicative of suffocation or choking can reduce their worry from the breathing sounds.

Families and caregivers may also feel guilty about stopping treatments, fearing that they are “killing” the patient. This may lead to demands for interventions that may be ineffective. In such cases, the physician should remind the family and caregivers about the inevitability

of events and the palliative goals. Interventions may prolong the dying process and cause discomfort. Physicians should also emphasize that withholding treatments is both legal and ethical, and that the family members are not the cause of the patient’s death. This reassurance may need to be provided multiple times.

Hearing and touch are said to be the last senses to stop functioning. Whether this is the case or not, families and caregivers can be encouraged to communicate with the dying patient. Encouraging them to talk directly to the patient, even if he or she is unconscious, and hold the patient’s hand or demonstrate affection in other ways can be an effective way to channel their urge “to do something” for the patient.

When the plan is for the patient to die at home, the physician must inform the family and caregivers how to determine that the patient has died. The cardinal signs are cessation of cardiac function and respiration; the pupils become fixed; the body becomes cool; muscles relax; and incontinence may occur. Remind the family and caregivers that the eyes may remain open even when the patient has died because the retroorbital fat pad may be depleted, permitting the orbit to fall posteriorly, which makes it difficult for the eyelids to cover the eyeball.

The physician should establish a plan for who the family or caregivers will contact when the patient is dying or has died. Without a plan, they may panic and call 911, unleashing a cascade of unwanted events from arrival of emergency personnel and resuscitation to hospital admission. The family and caregivers should be instructed to contact the hospice (if one is involved), the covering physician, or the on-call member of the palliative care team. They should also be told that the medical examiner need not be called, unless the state requires it for all deaths. Unless foul play is suspected, the health care team need not contact the medical examiner either.

Just after the patient dies, even the best-prepared family may experience shock and loss and be emotionally distraught. They need time to assimilate the event and be comforted. Health care providers may find it meaningful to write a bereavement card or letter to the family. The purpose is to communicate about the patient, perhaps emphasizing the patient’s virtues, the honor it was to care for the patient, and express concern for the family’s hardship. Some physicians attend the funerals of their patients. Although this is beyond any medical obligation, the presence of the physician can be a source of support to the grieving family and provides an opportunity for closure for the physician.

Death of a spouse is a strong predictor of poor health, and even mortality, for the surviving spouse. It may be important to alert the spouse’s physician about the death to be aware of symptoms that might require professional attention.

**MANAGING CHANGES IN THE PATIENT'S CONDITION DURING THE FINAL DAYS AND HOURS**

<b>CHANGES IN THE PATIENT'S CONDITION</b>	<b>POTENTIAL COMPLICATION</b>	<b>FAMILY'S POSSIBLE REACTION AND CONCERN</b>	<b>ADVICE AND INTERVENTION</b>
Profound fatigue	Bedbound with development of pressure ulcers that are prone to infection, malodor, and pain, and joint pain	Patient is lazy and giving up.	Reassure family and caregivers that terminal fatigue will not respond to interventions and should not be resisted. Use an air mattress if necessary.
Anorexia	None	Patient is giving up; patient will suffer from hunger and will starve to death.	Reassure family and caregivers that the patient is not eating because he or she is dying; not eating at the end of life does not cause suffering or death. Forced feeding, whether oral, parenteral, or enteral, does not reduce symptoms or prolong life.
Dehydration	Dry mucosal membranes (see below)	Patient will suffer from thirst and die of dehydration.	Reassure family and caregivers that dehydration at the end of life does not cause suffering because patients lose consciousness before any symptom distress. Intravenous hydration can worsen symptoms of dyspnea by pulmonary edema and peripheral edema as well as prolong dying process.
Dysphagia	Inability to swallow oral medications needed for palliative care		Do not force oral intake. Discontinue unnecessary medications that may have been continued including antibiotics, diuretics, anti-depressants, and laxatives. If swallowing pills is difficult, convert essential medications (analgesics, antiemetics, anxiolytics, and psychotropics) to oral solutions, buccal, sublingual, or rectal administration.
"Death rattle"—noisy breathing		Patient is choking and suffocating.	Reassure the family and caregivers that this is caused by secretions in the oropharynx and the patient is not choking. Reduce secretions with scopolamine (0.2–0.4 mg SC q4h or 1–3 patches q3d) Reposition patient to permit drainage of secretions. Do not suction. Suction can cause patient and family discomfort, and is usually ineffective.
Apnea, Cheyne-Stokes respirations, dyspnea		Patient is suffocating.	Reassure family and caregivers that unconscious patients do not experience suffocation or air hunger. Apneic episodes are frequently a premonitory change. Opioids or anxiolytics may be used for dyspnea. Oxygen is unlikely to relieve dyspneic symptoms and may prolong the dying process.
Urinary or fecal incontinence	Skin breakdown if days until death Potential transmission of infectious agents to caregivers	Patient is dirty, malodorous, and physically repellent.	Remind family and caregivers to use universal precautions. Frequent changes of bedclothes and bedding. Use diapers, urinary catheter, or rectal tube if diarrhea or high urine output.
Agitation or delirium	Day/night reversal Hurt self or caregivers	Patient is in horrible pain and going to have a horrible death.	Reassure family and caregivers that agitation and delirium do not necessarily connote physical pain. Depending on the prognosis and goals of treatment, consider evaluating for causes of delirium and modify medications. Manage symptoms with haloperidol, chlorpromazine, diazepam, or midazolam.
Dry mucosal membranes	Cracked lips, mouth sores, and candidiasis can also cause pain. Odor	Patient may be malodorous, physically repellent.	Use baking soda mouthwash or saliva preparation q15–30min. Use topical nystatin for candidiasis. Coat lips and nasal mucosa with petroleum jelly q60–90min. Use ophthalmic lubricants q4h or artificial tears q30min.

## PALLIATIVE CARE SERVICES: HOW AND WHERE

Determining the best approach to providing palliative care to patients will depend on patient preferences, the availability of caregivers and specialized services in close proximity, institutional resources, and reimbursement. Hospice is a leading, but not the only, model of palliative care services. In the United States, the vast majority of hospice care is provided in residential homes. By 2002, just over 20% of hospice was provided in nursing homes. In the United States, Medicare pays for hospice services under Part A, the hospital insurance part of reimbursement. Two physicians must certify that the patient has a prognosis of  $\leq 6$  months, if the disease runs its usual course. Prognoses are probabilistic by their nature; patients are not required to die within 6 months but rather to have a condition from which half the individuals with it would not be alive within 6 months. Patients sign a hospice enrollment form that states their intent to forgo curative services related to their terminal illness, but they can still receive medical services for other comorbid conditions. Patients can also withdraw enrollment and reenroll later; the hospice Medicare benefit can be revoked later to secure traditional Medicare benefits. Payments to the hospice are per diem (or capitated), not fee-for-service. Payments are intended to cover physician services for the medical direction of the care team; regular home care visits by registered nurses and licensed practical nurses; home health aid and homemaker services; chaplain services; social work services; bereavement counseling; and medical equipment, supplies, and medications. No specific therapy is excluded, and the goal is for each therapy to be considered for its symptomatic (as opposed to disease-modifying) effect. Additional clinical care, including services of the primary physician, is covered by Medicare Part B, even while the hospice Medicare benefit is in place.

By 2005, the mean length of enrollment in a hospice was 59 days, with the median being 26 days. Such short stays create barriers to establishing high-quality palliative services in patients' homes and also place financial strains on hospice providers because the initial assessments are resource intensive. Physicians should initiate early referrals to the hospice to allow more time for patients to receive palliative care.

Hospice care has been the main way of securing palliative services for terminally ill patients. However, efforts are now being made to ensure continuity of palliative care across settings and through time. Palliative care services are becoming available as consultative services and more rarely as palliative care units in hospitals, in day care and other outpatient settings, and in nursing homes. Palliative care consultations for nonhospice

patients can be billed as for other consultations under Medicare Part B, the physician reimbursement part. Many believe palliative care should be offered to patients regardless of their prognosis. A patient, his or her family, and physicians should not have to make a "curative versus palliative care" decision because it is rarely possible to make such a decisive switch to embracing mortality.

## FUTURE DIRECTIONS

### OUTCOME MEASURES

Care near the end of life cannot be measured by most of the available validated outcome measures because palliative care does not consider death a bad outcome. Similarly, the family and patients receiving end-of-life care may not desire the elements elicited in current quality-of-life measurements. Symptom control, enhanced family relationships, and quality of bereavement are difficult to measure and are rarely the primary focus of carefully developed or widely used outcome measures. Nevertheless, outcomes are as important in end-of-life care as in any other field of medical care. Specific end-of-life care instruments are being developed both for assessment, such as The Brief Hospice Inventory and NEST (*needs near the end of life screening tool*), and for outcome measures, such as the Palliative Care Outcomes Scale, and for prognosis, such as the Palliative Prognostic Index. The field of end-of-life care is entering an era of evidence-based practice and continuous improvement through clinical trials.

### FURTHER READINGS

#### WEBSITES

- Education in Palliative and End of Life Care (EPEC) <http://www.epec.net>
- End of Life—Palliative Education Resource Center <http://www.eperc.mcw.edu>
- National Hospice and Palliative Care Organization (including state-specific advance directives) <http://www.nhpco.org>
- NCCN: The National Comprehensive Cancer Network palliative care guidelines <http://www.nccn.org>
- Center to Advance Palliative Care <http://www.capc.org>
- Family Caregiver Alliance <http://www.caregiver.org>
- National Family Caregivers Association <http://www.nfcares.org/>
- The Medical Directive <http://www.medicaldirective.org>
- American Academy of Hospice and Palliative Medicine [www.aahpm.org](http://www.aahpm.org)

#### BOOKS

- AMERICAN SOCIETY OF CLINICAL ONCOLOGY: *Optimizing Cancer Care—The Importance of Symptom Management*. Vols 1 and 2. Alexandria, VA, ASCO, 2001
- BUCKMAN R: *How to Break Bad News: A Guide for Health Care Professionals*. Baltimore, Johns Hopkins University Press, 1992

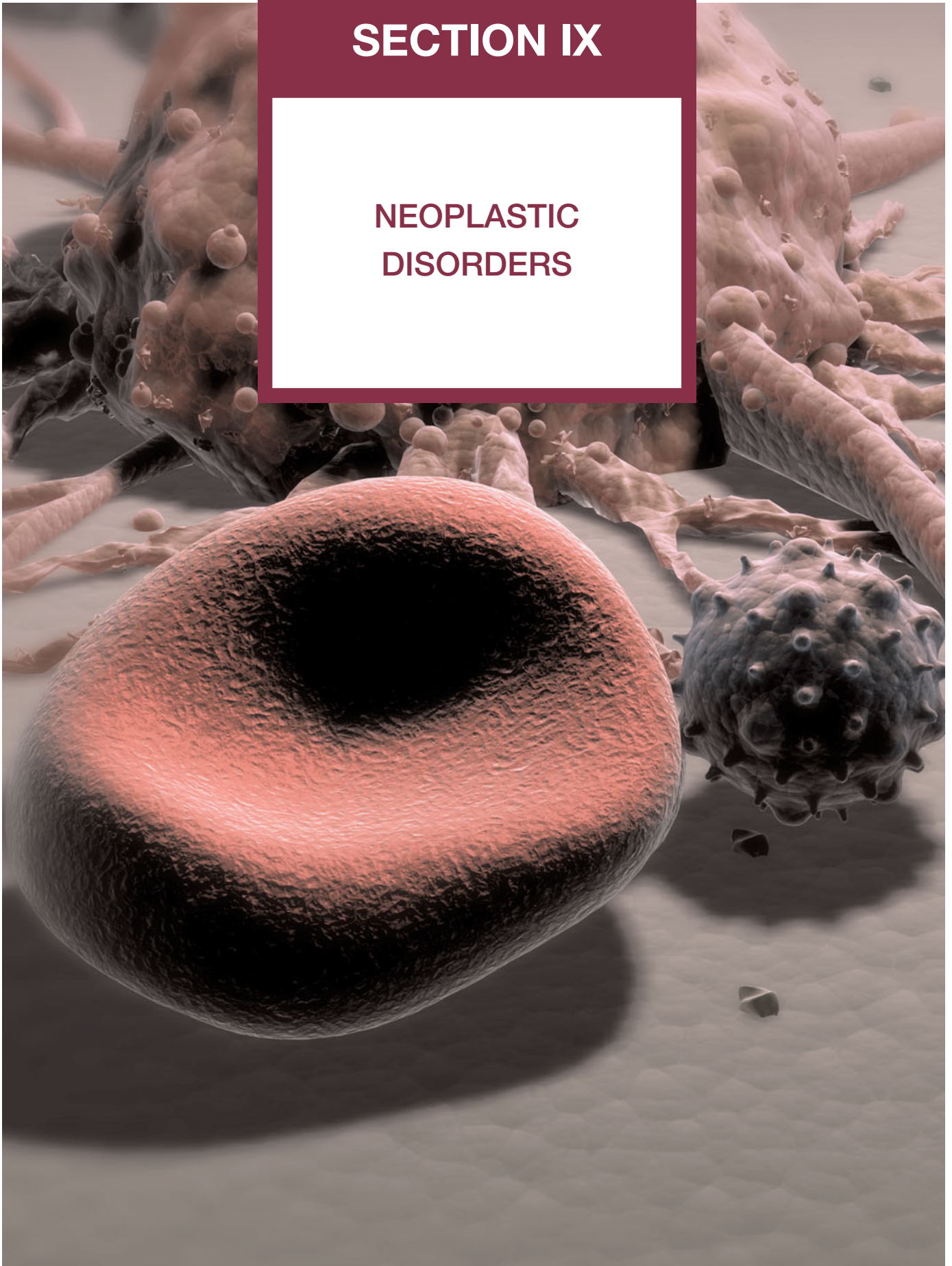
#### ARTICLES

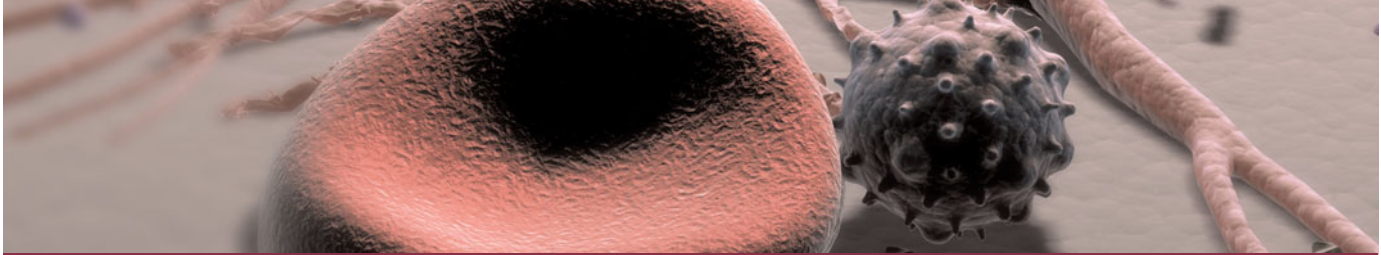
- CHRISTAKIS NA, ALLISON PD: Mortality after the hospitalization of a spouse. *N Engl J Med* 354:719, 2006.

- 420 EMANUEL L et al, for the PALLIATIVE CARE GUIDELINES GROUP OF THE AMERICAN HOSPICE FOUNDATION: Integrating palliative care into disease management guidelines. *J Palliat Med* 7:774, 2004
- HASSELAAR JG et al: When cancer symptoms cannot be controlled: The role of palliative sedation. *Curr Opin Support Palliat Care* 3:14, 2009
- KAPO J et al: Palliative care for the older adult. *J Palliat Med* 10:185, 2007
- LYNN J: Serving patients who may die soon and their families: The role of hospice and other services. *JAMA* 285:925, 2001
- MEISEL A et al, for the AMERICAN COLLEGE OF PHYSICIANS–AMERICAN SOCIETY OF INTERNAL MEDICINE END-OF-LIFE CARE CONSENSUS PANEL: Seven legal barriers to end-of-life care: Myths, realities, and grains of truth. *JAMA* 284:2495, 2000
- MULARSKI RA et al: Pain management within the palliative and end-of-life care experience in the ICU. *Chest* 135:1360, 2009
- MURRAY SA et al: Illness trajectories and palliative care. *BMJ* 330:1007, 2005
- OXBERRY SG, LAWRIE I: Symptom control and palliative care: Management of breathlessness. *Br J Hosp Med* 70:212, 2009
- WILFEN PJ: Evidence-based pain management and palliative care in issue one for 2009 of the Cochrane Library. *J Pain Palliat Care Pharmacother* 23:166, 2009
- ZAIDER T, KISSANE D: The assessment and management of family distress during palliative care. *Curr Opin Support Palliat Care* 3:67, 2009

# SECTION IX

## NEOPLASTIC DISORDERS





## CHAPTER 31

# CANCER OF THE SKIN

Arthur J. Sober ■ Hensin Tsao ■ Carl V. Washington, Jr.

■ Melanoma . . . . .	422	Etiology . . . . .	429
Epidemiology . . . . .	422	Clinical Presentation . . . . .	429
Clinical Characteristics . . . . .	422	Natural History . . . . .	430
Prognostic Factors . . . . .	423	Prevention . . . . .	431
Natural History . . . . .	424	Other Nonmelanoma Cutaneous	
Management . . . . .	424	Malignancies . . . . .	431
■ Nonmelanoma Skin Cancer . . . . .	428	■ Further Readings . . . . .	431

### MELANOMA

Pigmented lesions are among the most common findings on skin examination. The challenge is to distinguish cutaneous melanomas, which may be lethal, from the remainder, which with rare exceptions are benign. Examples of malignant and benign pigmented lesions are shown in [Fig. 31-1](#).

### EPIDEMIOLOGY

Melanomas originate from neural crest–derived melanocytes; pigment cells present normally in the epidermis and sometimes in the dermis. This tumor affects ~62,000 individuals per year in the United States, resulting in 7910 deaths. Melanoma is the fifth most common cancer in men (5% of cancers) and the sixth most common in women (4% of cancers). The tumor can affect adults of all ages, even young individuals (starting in the mid-teens); has distinct clinical features that make it detectable at a time when cure by surgical excision is possible; and is located on the skin surface, where it is visible. The incidence has increased dramatically (6% per year from 1973 to 1980, then 3% per year). Current lifetime risk ratio is 1:53 in males and 1:78 in females. The reason for this increase is uncertain but may involve increased recreational sun exposure, especially early in life. Individuals of similar ethnic background who immigrate after childhood to areas of high sun exposure (e.g., Israel and Australia) have

lower melanoma rates than individuals of similar age who were either born in those countries or immigrated before age 10. The individuals most susceptible to development of melanoma are those with fair complexions, red or blond hair, blue eyes, and freckles and who tan poorly and sunburn easily. Other factors associated with increased risk include a family history of melanoma (~1 in 10 melanoma patients have a family member with melanoma), the presence of a clinically atypical mole (dysplastic nevus) or a giant congenital melanocytic nevus, the presence of a higher than average number of ordinary melanocytic nevi, and immunosuppression ([Table 31-1](#)). Individuals with 50 or more moles  $\geq 2$  mm in size have a 64-fold increased risk. About 30% of melanomas arise in a nevus. Some individuals with multiple primary melanomas and/or a strong family history have heritable mutations in the *CDKN2A* gene. Melanoma is relatively rare in heavily pigmented peoples. Dark-skinned populations (such as those of India and Puerto Rico), blacks, and East Asians have rates 10–20 times lower than lighter-skinned whites. In keeping with the role of sun exposure, the incidence is inversely correlated with the latitude of residence; at any latitude, darker-skinned persons have the lowest incidence. Melanoma is rare in children under age 10.

### CLINICAL CHARACTERISTICS

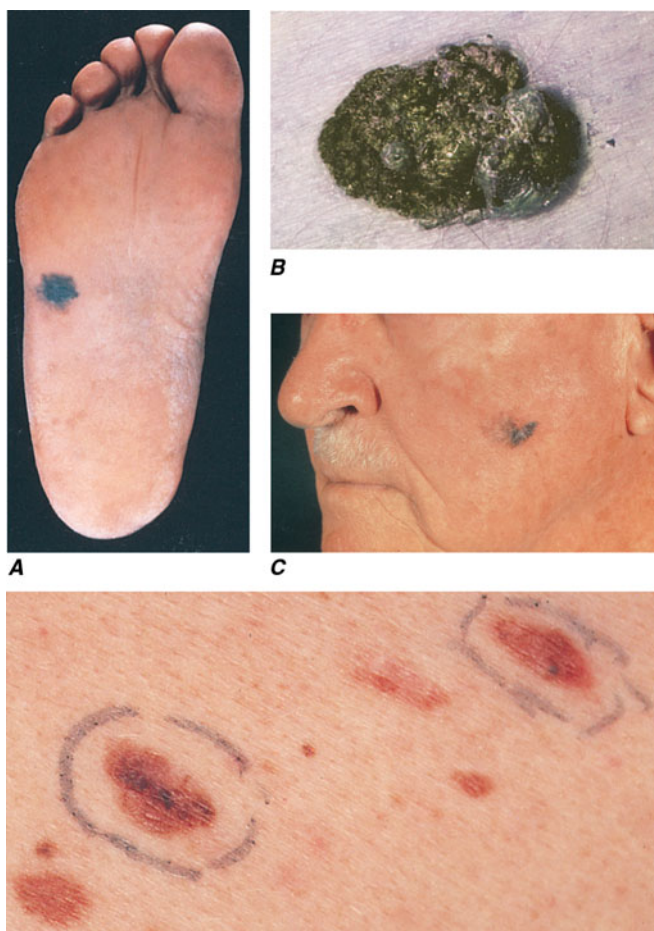
There are four types of cutaneous melanoma ([Table 31-2](#)). In three of these—*superficial spreading melanoma*, *lentigo*

TABLE 31-1

## RISK FACTORS FOR CUTANEOUS MELANOMA

High risk (>50-fold increase in risk)
Persistently changing mole
Clinically atypical moles in patient with two family members with melanoma
Adulthood (vs childhood)
>50 nevi $\geq 2$ mm in diameter
Intermediate risk (~10-fold increase in risk)
Family history of melanoma
Sporadic clinically atypical moles
Congenital nevi (?)
White ethnicity (vs black or East Asian ethnicity)
Personal history of prior melanoma
Low risk (2- to 4-fold increase in risk)
Immunosuppression
Sun sensitivity or excess exposure to sun

Source: Adapted from AR Rhodes et al: JAMA 258:3146, 1987.



D

FIGURE 31-1

**Atypical and malignant pigmented lesions.** The most common melanoma is superficial spreading melanoma (not pictured). **A.** Acral lentiginous melanoma is the most common melanoma in blacks, Asians, and Hispanics and occurs as an enlarging hyperpigmented macule or plaque on the palms and soles. Lateral pigment diffusion is present. **B.** Nodular melanoma most commonly manifests itself as a rapidly growing, often ulcerated or crusted black nodule. **C.** Lentigo maligna melanoma occurs on sun-exposed skin as a large, hyperpigmented macule or plaque with irregular borders and variable pigmentation. **D.** Dysplastic nevi are irregularly pigmented and shaped nevocellular lesions that may be associated with familial melanoma.

*maligna melanoma*, and *acral lentiginous melanoma*—the lesion has a period of superficial (so-called radial) growth during which it increases in size but does not penetrate deeply. It is during this period that the melanoma is most capable of being cured by surgical excision. The fourth type—*nodular melanoma*—does not have a recognizable radial growth phase and usually presents as a deeply invasive lesion, capable of early metastasis. When tumors begin to penetrate deeply into the skin, they are in the so-called vertical growth phase.

Melanomas with a radial growth phase are characterized by irregular and sometimes notched borders, variation in pigment pattern, and variation in color. An increase in size or change in color is noted by the patient in 70% of early lesions. Bleeding, ulceration, and pain are late signs and are of little help in early recognition. Superficial spreading melanoma is the most frequent variant observed in the white population. Melanomas arising in dysplastic nevi (see later) are usually of this type. The back is the most common site for melanoma in men. In women, the back and the lower leg (from knee to ankle) are common sites. Nodular melanomas are dark brown-black to blue-black nodules. Lentigo maligna melanoma is usually confined to chronically sun-damaged, sun-exposed sites (face, neck, back of hands) in older individuals. Acral lentiginous melanoma occurs on the palms, soles, nail beds, and mucous membranes. Although this type occurs in whites, it is most frequent (along with nodular melanoma) in blacks and East Asians.

A fifth type of melanoma, the *desmoplastic melanoma*, is recognized. This tumor type is associated with a fibrotic response to the tumor, neural invasion, and a higher tendency to local recurrence. Occasionally, melanomas can be amelanotic, in which case the diagnosis is established histologically after biopsy of a new or changing skin nodule or because of a suspicion of a basal cell carcinoma (see later).

## PROGNOSTIC FACTORS

The most important prognostic factor is the stage at the time of presentation. Fortunately, most melanomas are diagnosed in clinical stages I and II. The revised American Joint Committee on Cancer (AJCC) staging



## CLINICAL FEATURES OF MALIGNANT MELANOMA

TYPE	SITE	AVERAGE AGE AT DIAGNOSIS, YEARS	DURATION OF KNOWN EXISTENCE, YEARS	COLOR
Lentigo maligna melanoma	Sun-exposed surfaces, particularly malar region of cheek and temple	70	5–20 <sup>a</sup> or longer	In flat portions, shades of brown and tan predominant, but whitish gray occasionally present; in nodules, shades of reddish brown, bluish gray, bluish black
Superficial spreading melanoma	Any site (more common on upper back and, in women, on lower legs)	40–50	1–7	Shades of brown mixed with bluish red (violaceous), bluish black, reddish brown, and often whitish pink, and the border of lesion is at least in part visibly and/or palpably elevated
Nodular melanoma	Any site	40–50	Months to less than 5 years	Reddish blue (purple) or bluish black; either uniform in color or mixed with brown or black
Acral lentiginous melanoma	Palm, sole, nail bed, mucous membrane	60	1–10	In flat portions, dark brown predominantly; in raised lesions (plaques) brown-black or blue-black predominantly

<sup>a</sup>During much of this time, the precursor stage, lentigo maligna, is confined to the epidermis.

**Source:** Adapted from AJ Sober, in *Pathophysiology of Dermatologic Diseases*, NA Soter, HP Baden (eds). New York, McGraw-Hill, 1984.

system for melanoma is based on microscopic primary tumor depth (Breslow's thickness), presence of ulceration, evidence of nodal involvement, and presence of metastatic disease to internal sites (Table 31-3). Certain anatomic sites may affect the prognosis. The favorable sites appear to be the forearm and leg (excluding feet); unfavorable sites include scalp, hands, feet, and mucous membranes. In general, women with stage I or II disease have a better survival than men, perhaps in part because of earlier diagnosis; women frequently have melanomas on the lower leg, where self-recognition is more likely and prognosis is better. Older individuals, especially men >60 years of age, have poorer prognoses. This finding has been explained in part by a tendency toward later diagnosis (and thus thicker tumors) in men and by a higher proportion in men of acral melanomas (palmar-plantar), which have a poorer prognosis. Melanoma may recur after many years. About 10–15% of first-time recurrences develop >5 years after treatment of the original lesion. The time to recurrence varies inversely with tumor thickness. An alternative prognostic scheme for clinical stages I and II melanoma, proposed by Clark, is based on the anatomic level of invasion in the skin. Level I is intraepidermal (in situ); level II penetrates the papillary dermis; level III spans the papillary dermis; level IV penetrates the reticular dermis; and level V penetrates into the subcutaneous fat. The 5-year survival for these stages averages 100, 95, 82, 71, and 49%, respectively.

## NATURAL HISTORY

Melanomas may spread by the lymphatic channels or the bloodstream. The earliest metastases are often to regional lymph nodes. Lymphadenectomy may control early regional disease. Liver, lung, bone, and brain are common sites of hematogenous spread, but unusual sites, such as the anterior chamber of the eye, may also be involved. Once metastatic disease is established, cure is unlikely.

## MANAGEMENT

The entire cutaneous surface, including the scalp and mucous membranes, should be examined in each patient. Bright room illumination is important, and a 7× to 10× hand lens is helpful for evaluating variation in pigment pattern. A history of relevant risk factors should be elicited. Any suspicious lesions should be biopsied, evaluated by a specialist, or recorded by chart and/or photography for follow-up. Examination of the lymph nodes and palpation of the abdominal viscera are part of the staging examination for suspected melanoma. The patient should be advised to have other family members screened if either melanoma or clinically atypical moles (dysplastic nevi) are present. The detection of early melanoma in relatives has been reported.

Melanoma prevention is based on protection from the sun. Routine use of a broad spectrum UV-A/UV-B sunblock with sun protection factor ≥15, use of protective

TABLE 31-3

PROGNOSIS OF MELANOMA BY THICKNESS (BRESLOW) AND REVISED AJCC STAGES: 5-YEAR SURVIVAL RATES				
AJCC STAGE	THICKNESS, mm	ULCERATION	NODAL DISEASE	DISTANT METASTASES
0	In situ	N/A	No	No
IA	<1	No	No	No
IB	<1	Yes	No	No
	1.01–2.0	No	No	No
IIA	1.01–2.0	Yes	No	No
	2.01–4.0	No	No	No
IIB	2.01–4.0	Yes	No	No
	>4.0	No	No	No
IIC	>4.0	Yes	No	No
IIIA	Any	No	Yes	
			1 node w/microscopic disease	No
IIIB	Any	Yes	2–3 nodes w/microscopic disease	No
			1 node w/microscopic disease	No
			2–3 nodes w/microscopic disease	No
			1 node w/macrosopic disease	No
			2–3 nodes w/macrosopic disease	No
			In transit or satellite disease w/out nodal disease	No
IIIC	Any	Yes	1 node w/macrosopic disease	No
			2–3 nodes w/macrosopic disease	No
			≥4 metastatic or matted nodes, or in transit mets/satellites or metastatic nodes	No
IV	Any	Any	Any	Yes

**Note:** AJCC, American Joint Commission for Cancer.

clothing, and avoiding intense midday ultraviolet exposure should be recommended. The patient should be educated in the clinical features of melanoma and advised to report any growth or other change in a pigmented lesion. Patient education brochures are available from the American Cancer Society, the American Academy of Dermatology, the National Cancer Institute, and the Skin Cancer Foundation. Self-examination at 6- to 8-week intervals may enhance the likelihood of detecting change. The importance of routine follow-up visits for melanoma patients and patients with clinically atypical moles (dysplastic nevi) should be emphasized because these visits may facilitate early detection of new primary tumors.

### Precursor Lesions

Clinically atypical moles, also termed *dysplastic nevi*, occur in certain families affected by melanoma. In some families, melanomas occur nearly exclusively in the individuals with dysplastic nevi. In other families, the nevi may not be present in all individuals with an increased risk of melanoma. The melanomas may arise in clinically atypical moles or in normal skin (in the latter situation the moles act as markers of increased risk). Individuals with clinically atypical moles and a strong family history of melanoma have been reported to have a >50%

lifetime risk for developing melanoma. **Table 31-4** lists the features that are characteristic of clinically atypical moles and that differentiate them from benign acquired nevi. The number of clinically atypical moles may vary from one to several hundred. Clinically atypical moles usually differ from each other in appearance. The borders are often hazy and indistinct, and the pigment pattern is more highly varied than that in benign acquired nevi. Of the 90% of melanoma patients whose disease is regarded as sporadic (i.e., who lack a family history of melanoma), ~40% have clinically atypical moles, as compared with an estimated 5–10% of the population at large. Further studies to determine the background frequency of clinically atypical moles are required, once greater unanimity exists regarding their clinical and histopathologic features. The observation that sporadic melanomas can arise in association with a clinically atypical mole makes this the most important precursor for melanoma. Less frequent precursors include the giant congenital melanocytic nevus. Congenital melanocytic nevi are present at birth or appear in the neonatal period (tardive form). The *giant melanocytic nevus*, also called the bathing trunk, cape, or garment nevus, is a rare malformation that affects perhaps 1 in 30,000 to 1 in 100,000 individuals. These nevi are usually >20 cm in diameter and may cover more than half the body surface. Giant nevi often occur in association with

## CLINICAL FEATURES DISTINGUISHING ATYPICAL MOLES FROM BENIGN ACQUIRED NEVI

CLINICAL FEATURE	CLINICALLY ATYPICAL MOLES	BENIGN ACQUIRED NEVI
Color	Variable mixtures of tan, brown, black, or red/pink within a single nevus; nevi may look very different from each other	Uniformly tan or brown
Shape	Irregular borders; pigment may fade off into surrounding skin; macular portion at the edge of the nevus	Round; sharp, clear-cut borders between the nevus and the surrounding skin; may be flat or elevated
Size	Usually >6 mm in diameter; may be >10 mm; occasionally <6 mm	Usually <6 mm in diameter
Number	Often very many (>100), but occasionally may be only one	In a typical adult, 10 to 40 are scattered over the body; perhaps 15% of patients have no nevi
Location	Sun-exposed areas; the back is the most common site, but dysplastic nevi may also be seen on the scalp, breasts, and buttocks	Generally on the sun-exposed surfaces of the skin above the waist; the scalp, breasts, and buttocks are rarely involved

Source: Modified from RJ Friedman et al: CA—A Cancer J Clinicians 33(3):130, 1985.

multiple small congenital nevi. The borders are sharp, and hair may be present. The lesions are usually dark brown and may have darker and lighter areas. Pigment is haphazardly displayed. The surface is smooth to rugose or cerebriform and may vary from one portion of the lesion to another.

A lifetime risk of melanoma development of 6% has been estimated. The risk is greatest before age 5 and next greatest between ages 5 and 10. Early detection of melanoma is difficult in these lesions because of the deep dermal or subcutaneous origin of primary melanoma and because of the large and varied surface of the nevus. Prophylactic excision early in life can be accomplished by staged removal with coverage by split-thickness skin grafts. Surgery cannot remove all at-risk nevus cells because some may penetrate into the muscles or central nervous system below the nevus. At present there are no uniform management guidelines for giant congenital nevi. The *small- to medium-sized congenital melanocytic nevus*, which affects approximately 1% of persons, usually presents as a raised dark- to medium-brown lesion with a smooth or papillomatous surface. The border is sharp, and lesions may be oriented along lines of skin cleavage. Follicular hyper- and hypopigmentation may coexist in a salt-and-pepper configuration. The lesion may have an excess of thick, coarse hairs. The risk of melanoma developing in these lesions is not known but appears to be relatively small. The management of small- to medium-sized congenital melanocytic nevi remains controversial. Melanomas in small congenital melanocytic nevi appear to occur after puberty, unlike melanomas that arise in giant congenital nevi and tend to occur much earlier in life. Melanomas can also arise in benign dermal and compound moles. Overall, it has been estimated that for a 20-year-old individual, the lifetime risk of any selected

mole transforming into melanoma by age 80 years is approximately 0.03% (1 in 3,164) for men and 0.009% (1 in 10,800) for women.

### Differential Diagnosis

The aim of differential diagnosis is to distinguish benign pigmented lesions from melanoma and its precursor. If melanoma is a consideration, then biopsy is appropriate. Some benign look-alikes may be removed in the process of trying to detect authentic melanoma. **Table 31-5** summarizes the distinguishing features of benign lesions that may be confused with melanoma. Early detection of melanoma may be facilitated by applying the “ABCD rules”: A—*asymmetry*, benign lesions are usually symmetric; B—*border irregularity*, most nevi have clear-cut borders; C—*color variegation*, benign lesions usually have uniform light or dark pigment; D—*diameter >6 mm* (the size of a pencil eraser). Of these criteria, the weakest is diameter >6 mm because a significant fraction of melanomas are now diagnosed with diameters <6 mm. In addition, the preceding features are less helpful in the recognition of nodular melanomas, which may be symmetric and have uniform colors. “Different” has been substituted for “diameter” by some. Addition of an “E” for *evolution* has been proposed because other features may become more significant if the lesion is changing.

### Biopsy

Any pigmented cutaneous lesion that has changed in size or shape or has other features suggestive of malignant melanoma is a candidate for biopsy. The recommended technique is an excisional biopsy because that facilitates pathologic assessment of the lesion, permits accurate measurement of thickness if the lesion is melanoma, and

TABLE 31-5

**PIGMENTED LESIONS THAT MUST BE DISTINGUISHED FROM CUTANEOUS MELANOMA AND ITS PRECURSORS**

Blue nevus	Gunmetal or cerulean blue, blue-gray. Stable over time. One-half occur on dorsa of hands and feet. Lesions are usually single, small, 3 mm to <1 cm. Must be distinguished from nodular melanoma.
Compound nevus	Round or oval shape, well-demarcated, smooth-bordered. May be dome-shaped or papillomatous; colors range from flesh colored to very dark brown, with individual nevi being relatively homogeneous in color.
Hemangioma	Dome-shaped reddish, purple, blue nodule. Compression with a glass microscope slide may result in blanching. Must be distinguished from nodular melanoma.
Junctional nevus	Flat to barely raised brown lesion. Sharp border. Fine pigmentary stippling visible, especially on magnification.
Lentigo Juvenile Solar	Flat, uniformly medium or dark brown lesion with sharp border. Solar lentigines are acquired lesions on sites of chronic solar exposure (face and backs of hands). Lesions are 2 mm to $\geq 1$ cm. Solar lentigines have reticulate pigmentation on magnification.
Pigmented basal cell carcinoma	Papular border. May have central ulceration. Usually on a sun-exposed surface in an older patient. Patient usually has dark brown eyes and dark brown or black hair.
Pigmented dermatofibroma	Lesion is not well demarcated visually, is firm, and dimples downward when compressed laterally. Usually on extremities. Usually <6 mm.
Seborrheic keratosis	Rough, sharp-bordered lesions that feel waxy and “stuck on”; range in color from flesh to tan, to dark brown. Presence of keratin plugs in surface is helpful for discriminating especially dark lesions from melanoma.
Subungual hematoma	Maroon (red-brown) coloration. As lesion grows out from nail fold, a curving clear area is seen.
Tattoo (medical or traumatic)	In medical tattoo, lesions are small pigmentary dots, often blue or green, which make a regular pattern (rectangle). Traumatic tattoos are irregular, and pigmentation may appear black.

constitutes treatment if the lesion is benign. For large lesions or lesions on anatomic sites where excisional biopsy may not be feasible (such as the face, hands, or feet), an incisional biopsy through the most nodular or darkest area of the lesion is acceptable; this should

include the vertical growth phase of the primary tumor, if present. Incisional biopsy does not appear to facilitate the spread of melanoma.

### Staging

Once the diagnosis of malignant melanoma has been confirmed, the tumor must be staged to determine prognosis and treatment. The history should probe for evidence of metastatic disease, such as malaise, weight loss, headaches, visual difficulty, or bone pain. The physical examination should be directed especially to the skin, regional draining lymph nodes, central nervous system, liver, and spleen. In the absence of signs or symptoms of metastasis, few laboratory or radiologic tests are indicated for staging purposes. No tests or scans are routinely indicated unless the history or physical examination suggests metastasis to a specific organ. Once signs of metastasis exist, favored sites of spread, such as the liver, lungs, bone, and brain, should be evaluated. Patients are classified into four stages (Table 31-3).

### **R<sub>x</sub>** Treatment: MELANOMA

**SURGICAL MANAGEMENT** For a newly diagnosed cutaneous melanoma, wide surgical excision of the lesion with a margin of normal skin is necessary to remove all malignant cells and minimize possible local recurrence. The appropriate width of the margin is a source of controversy. A World Health Organization trial that prospectively randomized between 1- and 3-cm margins in 612 patients with thin malignant melanomas ( $\leq 2$  mm thick) reported that the narrower margin resulted in higher rates of local recurrence but no difference in rates of nodal or distant metastases, disease-free survival, or overall survival. Another large randomized trial comparing 2- or 4-cm surgical margins for intermediate-thickness lesions (1–4 mm thick) also found no significant differences in overall survival. The following margins can be recommended for primary melanoma: in situ: 0.5 cm; invasive up to 1 mm thick: 1.0 cm; >1 mm: 2.0 cm. For lesions on the face, hands, and feet, strict adherence to these margins must give way to individual considerations about the constraints of surgery and minimization of morbidity. In all instances, however, inclusion of subcutaneous fat in the surgical specimen facilitates adequate thickness measurement and assessment of surgical margins by the pathologist.

**Sentinel Node Biopsy** Sentinel node biopsy (SLNB) has replaced elective regional nodal dissection for the evaluation of regional nodal status. The initial draining node(s) from the primary site is/are identified by injecting a blue dye and a radioisotope around the primary site. The initial draining node(s) is/are then identified by

inspection of the nodal basin for the blue-stained node and/or the node with high uptake of the radioisotope. The identified nodes are removed and subjected to careful histopathologic processing with serial section hematoxylin and eosin stains as well as immunohistochemical stains that identify melanocytes. Sentinel lymph node examination is a valuable staging tool, and in the instance of a negative biopsy, SLNB may obviate the need for complete nodal dissection. Patients with lesions <0.75 mm thick have an excellent prognosis and are not candidates for SLNB unless other high-risk features are present (ulceration, shave biopsy with base involved, etc.). At the other extreme, patients with lesions >4 mm thick have such a high risk for distant metastases that controlling nodal disease may not alter the ultimate clinical outcome. A subset of patients with lesions of intermediate thickness may have a survival benefit from regional node dissection. SLNB is of value in selecting patients who may benefit from adjuvant therapy. Survival benefit of SLNB remains to be proven.

#### ADJUVANT THERAPY FOR NODAL DISEASE

For patients who are free of disease but at high risk for metastases, adjuvant therapy that complements surgery is needed to destroy occult micrometastases, prolong disease-free survival, and improve the cure rate. Many strategies have been tried unsuccessfully. However, adjuvant interferon (IFN)  $\alpha 2b$  may be capable of improving disease-free and overall survival in patients with nodal metastases (stage III disease). The U.S. Food and Drug Administration has approved a high-dose IFN adjuvant protocol consisting of 20 million units per square meter IV 5 days a week for 4 weeks followed by 10 million units per square meter SC three times a week for 11 months. In a large fraction of patients, these doses of IFN are associated with severe toxicity, including a flulike illness and decline in performance status. The toxicity in most patients reverses promptly with lower doses and when therapy is stopped.

#### TREATMENT OF METASTATIC DISEASE

Melanoma can metastasize to any internal organ, with the brain a particularly common site. Metastatic melanoma is generally incurable, with survival in patients with visceral metastases generally <1 year. Thus the goal of treatment is usually palliation. Patients with soft tissue and nodal metastases fare better than those with liver and brain metastases. Metastases limited to regional nodes (AJCC stage III disease) warrant a therapeutic lymph node dissection. Surgical excision of a single metastasis to the lung or to a surgically accessible brain site can prolong survival. Stereotactic radiosurgery has been successful in the treatment of isolated brain metastases. Radiation therapy can provide local palliation for recurrent tumors or metastases. Patients who have advanced regional disease limited to a limb may benefit from hyperthermic limb perfusion with melphalan. High complete response rates have been

reported, and responses are associated with significant palliation of symptoms.

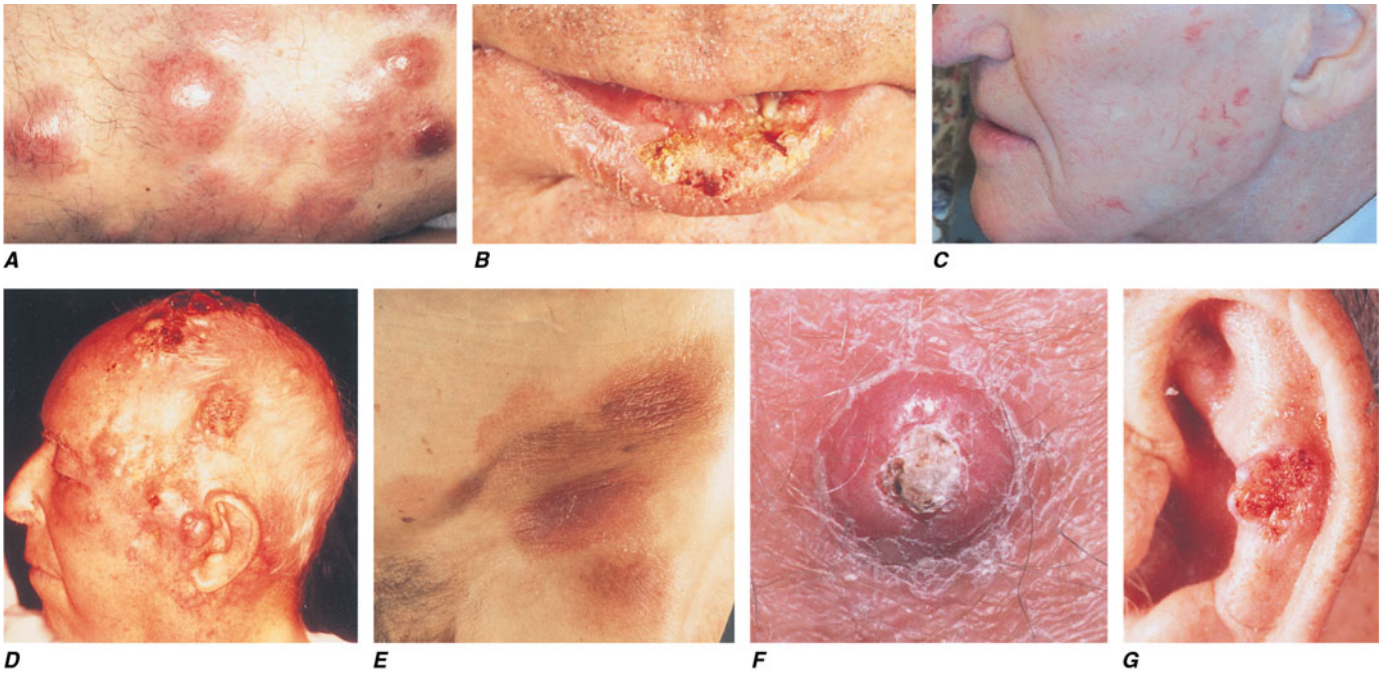
A number of drugs and biological therapies have demonstrated minimal antitumor activity (15–20% partial response rates) in metastatic melanoma, including dacarbazine (DTIC); the nitrosoureas carmustine (BCNU), lomustine (CCNU), and semustine (methyl-CCNU); platinum analogues such as cisplatin and carboplatin; vinca alkaloids such as vincristine, vinblastine, and vindesine; the taxanes paclitaxel and docetaxel; IFN- $\alpha$ ; and interleukin 2 (IL-2). Although limited in efficacy, single-agent dacarbazine is still considered the standard treatment. Ongoing trials are attempting to define superior combinations. IL-2 produces response rates similar to those seen with cytotoxic agents; however, active doses usually cause greater toxicity than chemotherapy. Response rates of >50% have been observed with IL-2 for intracutaneous and subcutaneous disease.

Melanoma can express cell-surface antigens that may be recognized by host immune cells. These melanoma-associated antigens alone or in combination may make it possible to develop vaccination strategies against melanoma. Such strategies include the use of purified tumor proteins as immunogens and the use of genetically altered tumor cells to elicit a T cell response. Alternative experimental approaches include efforts to expand tumor-specific T cells (either obtained from the tumor as tumor-infiltrating lymphocytes or harvested from the peripheral blood after vaccination) in vitro and transfer them into patients in large numbers. In addition, monoclonal antibodies to tumor antigens are being evaluated. Agents directed against the cell cycle pathways are also currently in trial. All of these experimental approaches will need considerable further development before being applicable on a wide scale. Advances in treating metastatic disease may also prove applicable in the adjuvant setting.

The absence of curative therapy for patients with metastatic melanoma underscores the importance of early detection and prevention as strategies to decrease melanoma mortality. Patients with stage 4 melanoma are best treated by medical oncologists with expertise in treating patients with advanced disease. Clinical trials should be considered as an option for this patient group.

## NONMELANOMA SKIN CANCER

Nonmelanoma skin cancer (NMSC) is the most common cancer in the United States, with an estimated annual incidence of >1.5 million cases. Basal cell carcinomas (BCCs) account for 70–80% of NMSCs. Squamous cell carcinomas (SCCs), although representing only ~20% of NMSC, are more significant because of their ability to metastasize ([Fig. 31-2](#)); they account for most of the 2400 deaths annually. Incidence rates have risen dramatically over the past decade.



**FIGURE 31-2**

**Cutaneous neoplasms.** **A.** Non-Hodgkin's lymphoma involves the skin with typical violaceous, "plum-colored" nodules. **B.** Squamous cell carcinoma is seen here as a hyperkeratotic crusted and somewhat eroded plaque on the lower lip. Sun-exposed skin such as the head, neck, hands, and arms are other typical sites of involvement. **C.** Actinic keratoses consist of hyperkeratotic erythematous papules and patches on sun-exposed skin. They arise in middle-aged to older adults and

have some potential for malignant transformation. **D.** Metastatic carcinoma to the skin is characterized by inflammatory, often ulcerated dermal nodules. **E.** Mycosis fungoides is a cutaneous T cell lymphoma, and plaque stage lesions are seen in this patient. **F.** Keratoacanthoma is a low-grade squamous cell carcinoma that presents as an exophytic nodule with central keratinous debris. **G.** This basal cell carcinoma shows central ulceration and a pearly, rolled, telangiectatic tumor border.

## ETIOLOGY

The causes of BCC and SCC are multifactorial. Cumulative exposure to sunlight, principally the ultraviolet B (UV-B) spectrum, is the most significant factor. Emerging data suggest that ultraviolet A radiation may be more carcinogenic than previously believed. Other factors associated with a higher incidence of skin cancer are male sex, older age, Celtic descent, a fair complexion, a tendency to sunburn easily, and an outdoor occupation. The incidence of these tumors increases with decreasing latitude. Most tumors develop on sun-exposed areas of the head and neck. Tumors are more common on the left side of the body in the United States but on the right side in England, presumably owing to asymmetric exposure during driving. As the earth's ozone shield continues to thin, further increases in the incidence of skin cancer are anticipated. In certain geographic areas, exposure to arsenic in well water or from industrial sources may significantly increase the risk of BCC and SCC. Skin cancer in affected individuals may be seen with or without other cutaneous markers of chronic arsenism (e.g., arsenical keratoses). Less common is exposure to the cyclic aromatic hydrocarbons in tar, soot, or shale. The risk of lip or oral SCC is increased with cigarette smoking. Human papillomaviruses and UV radiation may act as cocarcinogens.

Host factors associated with a high risk of skin cancer include immunosuppression induced by disease or drugs. Transplant recipients receiving chronic immunosuppressive therapy are particularly prone to SCC. The frequency of skin cancer is proportional to the duration of immunosuppression and the extent of sun exposure both before and after transplantation. Skin cancer is not uncommon in patients infected with HIV, and it may be more aggressive in this setting. Other factors include ionizing radiation, thermal burn scars, and chronic ulcerations. Several heritable conditions are associated with skin cancer (e.g., albinism, xeroderma pigmentosum, and basal cell nevus syndrome). Mutations in the tumor suppressor *patch* gene have been implicated in the development of BCC.

## CLINICAL PRESENTATION

NMSCs are often asymptomatic, but nonhealing ulceration, bleeding, or pain can occur in advanced lesions.

### Basal Cell Carcinoma

BCC is a malignancy arising from epidermal basal cells. The least invasive of BCC subtypes, *superficial BCC*, classically consists of truncal erythematous, scaling plaques that slowly enlarge. This BCC subtype may be confused

with benign inflammatory dermatoses, especially nummular eczema and psoriasis. BCC can also present as a small, slow-growing pearly nodule, often with small telangiectatic vessels on its surface (*nodular BCC*). The occasional presence of melanin in this variant of nodular BCC (*pigmented BCC*) may lead to confusion clinically with melanoma. *Morpheaform (fibrosing) BCC* and *micronodular BCC*, the most invasive subtypes, manifest as solitary, flat or slightly depressed, indurated, whitish or yellowish plaques. Borders are typically indistinct, a feature associated with a greater potential for extensive subclinical spread.

### Squamous Cell Carcinoma

Primary *cutaneous SCC* is a malignant neoplasm of keratinizing epidermal cells. SCC can grow rapidly and metastasize. The clinical features of SCC vary widely. Commonly, SCC appears as an ulcerated erythematous nodule or superficial erosion on the skin or lower lip, but it may present as a verrucous papule or plaque. Overlying telangiectasias are uncommon. The margins of this tumor may be ill-defined, and fixation to underlying structures may occur. Cutaneous SCC may develop anywhere on the body but usually arises on sun-damaged skin. A related neoplasm, keratoacanthoma, typically appears as a dome-shaped papule with a central keratotic crater, expands rapidly, and commonly regresses without therapy. This lesion can be difficult to differentiate from SCC.

*Actinic keratoses* and *cheilitis*, both premalignant forms of SCC, present as hyperkeratotic papules on sun-exposed areas. The potential for malignant degeneration in untreated lesions ranges from 0.25 to 20%. *Bowen's disease*, an in situ form of SCC, presents as a scaling, erythematous plaque. Treatment of premalignant and in situ lesions reduces the subsequent risk of invasive disease.

## NATURAL HISTORY

### Basal Cell Carcinoma

The natural history of BCC is that of a slowly enlarging, locally invasive neoplasm. The degree of local destruction and risk of recurrence vary with the size, duration, location, and histologic subtype of the tumor; presence of recurrent disease; and various patient characteristics. Location on the central face, ears, or scalp may portend a higher risk. Small nodular, pigmented, cystic, or superficial BCCs respond well to most treatments. Large lesions and micronodular and morpheaform subtypes may be more aggressive. The metastatic potential of BCC has been estimated to be 0.0028–0.1%. Persons with either BCC or SCC have an increased risk of developing subsequent skin cancers, estimated to be up to 40% in 5 years.

### Squamous Cell Carcinoma

The natural history of SCC depends on both tumor and host characteristics. Tumors arising on actinically damaged

skin have a lower metastatic potential than those on protected surfaces. The metastatic frequency of cutaneous SCC, reported at 0.3–5.2%, occurs most frequently in regional draining lymph nodes. Tumors occurring on the lower lip and ear have metastatic potentials approaching 13% and 11%, respectively. The metastatic potential of SCC arising in scars, chronic ulcerations, and genital or mucosal surfaces is higher. The overall metastatic rate for recurrent tumors may approach 30%. Large, poorly differentiated, deep tumors, with perineural or lymphatic invasion, often behave aggressively. Multiple tumors with rapid growth and aggressive behavior can be a therapeutic challenge in immunosuppressed patients.

## Rx Treatment: NONMELANOMA SKIN CANCER

**BASAL CELL CARCINOMA** The most frequently employed treatment modalities for BCC include electrodesiccation and curettage (ED&C), excision, cryosurgery, radiation therapy, laser therapy, Mohs micrographic surgery (MMS), topical 5-fluorouracil, and topical immunomodulators. The mode of therapy chosen depends on tumor characteristics, patient age, medical status, preferences of the patient, and other factors. ED&C remains the method most commonly employed by dermatologists. This method is selected for low-risk tumors (e.g., a small primary tumor of a less aggressive subtype in a favorable location). Excision, which offers the advantage of histologic control, is usually selected for more aggressive tumors or those in high-risk locations or, in many instances, for aesthetic reasons. Cryosurgery employing liquid nitrogen may be used for certain low-risk tumors but requires specialized equipment (cryoprobes) to be effective for advanced neoplasms. Radiation therapy, although not used as often, offers an excellent chance for cure in many cases of BCC. It is useful in patients not considered surgical candidates and as a surgical adjunct in high-risk tumors. Younger patients may not be good candidates for radiation therapy because of the risks of long-term carcinogenesis and radiodermatitis. Despite rapidly advancing technology in laser development, their long-term efficacy in treating infiltrative or recurrent lesions is still unknown. However, MMS, a specialized type of surgical excision that permits the best histologic control and preservation of uninvolved tissue, is associated with cure rates >98%. It is the preferred modality for lesions that are recurrent, in a high-risk location, or large and ill-defined and where maximal tissue conservation is critical (e.g., the eyelids). Topical 5-fluorouracil therapy should be limited to superficial BCC. New topicals, the immunomodulators, show promise in their efficacy at treating superficial and even nodular BCCs. Imiquimod, a relatively well-tolerated cream, has successfully undergone phase III clinical trials.

TABLE 31-6

OTHER NONMELANOMA CUTANEOUS MALIGNANCIES			
TUMOR TYPE	MOST COMMON LOCATION	RECURRENCE RATE, <sup>a</sup> %	METASTATIC RATE, %
Atypical fibroxanthoma	Head and neck	21	4
Merkel cell carcinoma	Head and neck	40	75
Dermatofibrosarcoma protuberans	Trunk	50	1
Sebaceous carcinoma	Eyelid	12	30
Microcystic adnexal carcinoma	Face	50	1 case
Porocarcinoma	Extremity	20	10
Eccrine carcinoma	Head and neck	36	11
Angiosarcoma	Head and neck	75	75

<sup>a</sup>Recurrence rates are the highest reported and were established prior to widespread use of Mohs micrographic surgery.

Intralesional chemotherapy (5-fluorouracil and INF) and photodynamic therapy (which employs selective activation of a photoactive drug by visible light) have been used successfully in patients with numerous tumors. A topical endonuclease (T4N5 liposome lotion) has been shown to repair DNA and may decrease the rate of NMSC in xeroderma pigmentosum.

**SQUAMOUS CELL CARCINOMA** The therapy of cutaneous SCC should be based on an analysis of risk factors influencing the biologic behavior of the tumor. These include the size, location, and degree of histologic differentiation of the tumor as well as the age and physical condition of the patient. Surgical excision, MMS, and radiation therapy are standard methods of treatment. Cryosurgery and ED&C have been used successfully for premalignant lesions and small primary tumors. Metastases are treated with lymph node dissection, irradiation, or both. 13-*cis*-retinoic acid (1 mg orally every day) plus INF- $\alpha$  (3 million units SC or IM every day) may produce a partial response in most patients. Systemic chemotherapy combinations that include cisplatin may also be palliative in some patients.

## PREVENTION

Because the vast majority of skin cancers are related to chronic UV radiation exposure, patient and physician education could dramatically reduce their incidence. Emphasis should be placed on preventive measures beginning early in life. Patients must understand that damage from UV-B begins early, despite the fact that cancers develop years later. Regular use of sunscreens and protective clothing should be encouraged. Avoidance of tanning salons and midday (10 A.M.–2 P.M.) sun exposure is recommended. Precancerous and in situ lesions should be treated early. Early detection of small tumors affords simpler treatment modalities with higher cure rates and lower morbidity. In patients with a history of skin cancer, long-term follow-up for the detection of recurrence, metastasis, and new skin cancers should be

emphasized. Chemoprophylaxis using synthetic retinoids is useful in controlling new lesions in some patients with multiple tumors.

## OTHER NONMELANOMA CUTANEOUS MALIGNANCIES

Neoplasms of cutaneous adnexa and sarcomas of fibrous, mesenchymal, fatty, and vascular tissues make up 1–2% of NMSC (Table 31-6). Some can portend a poor prognosis such as *Merkel cell carcinoma*, which is a neural crest–derived, highly aggressive malignancy that exhibits a metastatic rate of 75% and a 5-year survival rate of 30–40%. Others, such as the human herpes virus 8–induced, HIV-related *Kaposi's sarcoma*, exhibit a more indolent course. The marked decrease in incidence of this tumor parallels the institution of the highly active antiretroviral therapy.

### ACKNOWLEDGMENT

*Katarina G. Chiller, MD, and Howard K. Koh, MD, contributed to this chapter in the 16th edition of Harrison's Principles of Internal Medicine, and material from that chapter is included here.*

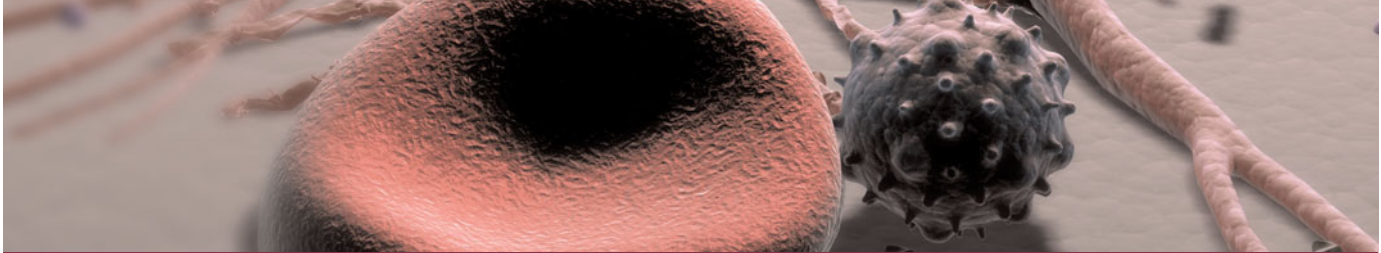
### FURTHER READINGS

- AMERICAN CANCER SOCIETY: Website at [www.cancer.org](http://www.cancer.org)
- BALCH CM et al: Prognostic factors analysis of 17,600 melanoma patients: Validation of the American Joint Committee on Cancer melanoma staging system. *J Clin Oncol* 19:3622, 2001
- et al: Final version of the AJCC staging system for cutaneous melanoma. *J Clin Oncol* 19:3635, 2001
- BHATIA S et al: Treatment of metastatic melanoma: An overview. *Oncology* 23:488, 2009
- CORNISH D et al: A systematic review of health-related quality of life in cutaneous melanoma. *Ann Oncol* 20 (suppl 6):vi51, 2009
- DRAKE LA et al: Guidelines of care of basal cell carcinoma. *J Am Acad Dermatol* 26:117, 1992
- et al: Guidelines of care for cutaneous squamous cell carcinoma. *J Am Acad Dermatol* 28:628, 1993
- GEISSE JK et al: Imiquimod 5% cream for the treatment of superficial basal cell carcinoma: A double-blind, randomized, vehicle-controlled study. *J Am Acad Dermatol* 47:390, 2002



- 432 JAMBUSARIA-PAHLAJANI A et al: Surgical monotherapy versus surgery plus adjuvant radiotherapy in high-risk cutaneous squamous cell carcinoma: A systematic review of outcomes. *Dermatol Surg* 35:574, 2009
- JOHNSON TM et al: Staging workup, sentinel node biopsy, and follow-up tests for melanoma: Update of current concepts, *Arch Dermatol* 140:107, 2004
- MORTON DL et al: Sentinel-node biopsy on nodal observation in melanoma. *N Engl J Med* 355:1307, 2006

- PETRELLA T et al: Single agent interleukin-2 in the treatment of metastatic melanoma: A systematic review. *Cancer Treat Rev* 33:484, 2007
- RIGEL DS et al: ABCDE: An evolving concept in the early diagnosis of melanoma. *Arch Dermatol* 141:1032, 2005
- SARNIAK AA, WEBER JS: Recent advances using anti-CTLA-4 for the treatment of melanoma. *Cancer J* 15:169, 2009
- TSAO H et al: Management of cutaneous melanoma. *N Engl J Med* 351:998, 2004



## CHAPTER 32

# HEAD AND NECK CANCER

Everett E. Vokes

Incidence and Epidemiology . . . . .	433
Etiology and Genetics . . . . .	433
Histopathology, Carcinogenesis, and Molecular Biology . . . . .	434
Clinical Presentation and Differential Diagnosis . . . . .	434
Chemoprevention . . . . .	437
Treatment Complications . . . . .	437
Salivary Gland Tumors . . . . .	438
■ Further Readings . . . . .	438

Epithelial carcinomas of the head and neck arise from the mucosal surfaces in the head and neck area and typically are squamous cell in origin. This category includes tumors of the paranasal sinuses, the oral cavity, and the nasopharynx, oropharynx, hypopharynx, and larynx. Tumors of the salivary glands differ from the more common carcinomas of the head and neck in etiology, histopathology, clinical presentation, and therapy. Thyroid malignancies are described in Chap. 45.

### INCIDENCE AND EPIDEMIOLOGY



The number of new cases of head and neck cancers in the United States was 40,500 in 2006, accounting for ~3% of adult malignancies. The worldwide incidence exceeds half a million cases annually. In North America and Europe, the tumors usually arise from the oral cavity, oropharynx, or larynx, whereas nasopharyngeal cancer is more common in the Mediterranean countries and in the Far East.

### ETIOLOGY AND GENETICS

Alcohol and tobacco use are the most common risk factors for head and neck cancer in the United States. Smokeless tobacco is an etiologic agent for oral cancers.

Other potential carcinogens include marijuana and occupational exposures such as nickel refining, exposure to textile fibers, and woodworking.

Dietary factors may contribute. The incidence of head and neck cancer is highest in people with the lowest consumption of fruits and vegetables. Certain vitamins, including carotenoids, may be protective if included in a balanced diet. Supplements of retinoids such as *cis*-retinoic acid have not been shown to prevent head and neck cancers (or lung cancer) and may increase the risk in active smokers.

Some head and neck cancers may have a viral etiology. The DNA of human papillomavirus (HPV) has been detected in the tissue of oral and tonsil cancers, and may predispose to oral and tonsillar cancer in the absence of tobacco and alcohol use. These patients can present at a somewhat younger age. The incidence of HPV-related head and neck cancer may be increasing. Epstein-Barr virus (EBV) infection is associated with nasopharyngeal cancer. Nasopharyngeal cancer occurs endemically in some countries of the Mediterranean and Far East, where EBV antibody titers can be measured to screen high-risk populations. Nasopharyngeal cancer has also been associated with consumption of salted fish.

No specific risk factors or environmental carcinogens have been identified for salivary gland tumors.

Squamous cell head and neck cancers can be divided into well-differentiated, moderately well-differentiated, and poorly differentiated categories. Poorly differentiated tumors have a worse prognosis than well-differentiated tumors. For nasopharyngeal cancers, the less common differentiated squamous cell carcinoma is distinguished from nonkeratinizing and undifferentiated carcinoma (lymphoepithelioma) that contains infiltrating lymphocytes.

Salivary gland tumors can arise from the major (parotid, submandibular, sublingual) or minor salivary glands (located in the submucosa of the upper aerodigestive tract). Most parotid tumors are benign, but half of submandibular and sublingual gland tumors and most minor salivary gland tumors are malignant. Malignant tumors include mucoepidermoid and adenoidcystic carcinomas and adenocarcinomas.

The mucosal surface of the entire pharynx is exposed to alcohol- and tobacco-related carcinogens and is at risk for the development of a premalignant or malignant lesion, such as erythroplakia or leukoplakia (hyperplasia, dysplasia), that can progress to invasive carcinoma. Alternatively, multiple synchronous or metachronous cancers can develop. In fact, over time patients with early-stage head and neck cancer are at greater risk of dying from a second malignancy than from a recurrence of the primary disease.

Second head and neck malignancies are usually not therapy-induced; they reflect the exposure of the upper aerodigestive mucosa to the same carcinogens that caused the first cancer. These second primaries develop in the head and neck area, the lung, or the esophagus. Rarely, patients can develop a radiation therapy–induced sarcoma after having undergone prior radiotherapy for a head and neck cancer.

Chromosomal deletions and other alterations, most frequently involving chromosomes 3p, 9p, 17p, and 13q, have been identified in both premalignant and malignant head and neck lesions, as have mutations in tumor suppressor genes, such as the p53 gene. Amplification of oncogenes is less common, but overexpression of PRAD-1/bcl-1 (cyclin D1), bcl-2, transforming growth factor  $\beta$ , and the epidermal growth factor receptor (EGFR) has been described. EGFR overexpression has been shown to be very common, and its extent seems to be of prognostic importance.

Resected tumor specimens with histopathologically negative margins (“complete resection”) can have residual tumor cells with persistent p53 mutations at the margins. Thus a tumor-specific p53 mutation can be detected in some phenotypically “normal” surgical margins, indicating residual disease. Patients with such submicroscopic marginal involvement may have a worse prognosis than patients with truly negative margins.

## CLINICAL PRESENTATION AND DIFFERENTIAL DIAGNOSIS

Most head and neck cancers occur after age 50, although these cancers can appear in younger patients, including those without known risk factors. The manifestations vary according to the stage and primary site of the tumor. Patients with nonspecific signs and symptoms in the head and neck area should be evaluated with a thorough otolaryngologic examination, particularly if symptoms persist longer than 2–4 weeks.

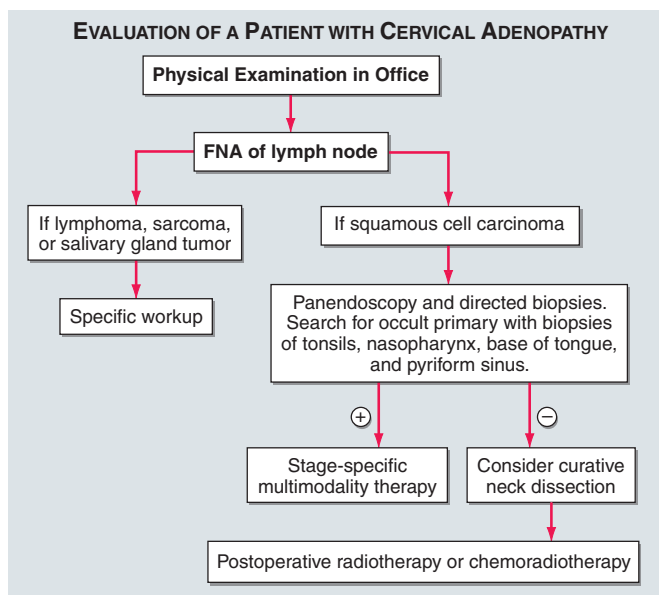
Cancer of the nasopharynx typically does not cause early symptoms. However, on occasion it may cause unilateral serous otitis media due to obstruction of the eustachian tube, unilateral or bilateral nasal obstruction, or epistaxis. Advanced nasopharyngeal carcinoma causes neuropathies of the cranial nerves.

Carcinomas of the oral cavity present as nonhealing ulcers, changes in the fit of dentures, or painful lesions. Tumors of the tongue base or oropharynx can cause decreased tongue mobility and alterations in speech. Cancers of the oropharynx or hypopharynx rarely cause early symptoms, but they may cause sore throat and/or otalgia.

Hoarseness may be an early symptom of laryngeal cancer, and persistent hoarseness requires referral to a specialist for indirect laryngoscopy and/or radiographic studies. If a head and neck lesion treated initially with antibiotics does not resolve in a short period, further workup is indicated; to simply continue the antibiotic treatment may be to lose the chance of early diagnosis of a malignancy.

Advanced head and neck cancers in any location can cause severe pain, otalgia, airway obstruction, cranial neuropathies, trismus, odynophagia, dysphagia, decreased tongue mobility, fistulas, skin involvement, and massive cervical lymphadenopathy, which may be unilateral or bilateral. Some patients have enlarged lymph nodes even though no primary lesion can be detected by endoscopy or biopsy; these patients are considered to have carcinoma of unknown primary (**Fig. 32-1**). If the enlarged nodes are located in the upper neck and the tumor cells are of squamous cell histology, the malignancy probably arose from a mucosal surface in the head or neck. Tumor cells in supraclavicular lymph nodes may also arise from a primary site in the chest or abdomen.

The physical examination should include inspection of all visible mucosal surfaces and palpation of the floor of mouth and tongue and of the neck. In addition to tumors themselves, leukoplakia (a white mucosal patch) or erythroplakia (a red mucosal patch) may be observed; these “pre-malignant” lesions can represent hyperplasia, dysplasia, or carcinoma in situ. All visible or palpable lesions should be biopsied. Further examination should be performed by a specialist. Additional staging procedures include CT of the head and neck to identify the extent of the disease. Patients with lymph node involvement should

**FIGURE 32-1**

**Evaluation of a patient with cervical adenopathy** without a primary mucosal lesion; a diagnostic workup. FNA, fine-needle aspiration.

have chest radiography and a bone scan to screen for distant metastases. The definitive staging procedure is an endoscopic examination under anesthesia, which may include laryngoscopy, esophagoscopy, and bronchoscopy; during this procedure, multiple biopsy samples are obtained to establish a primary diagnosis, define the extent of primary disease, and identify any additional premalignant lesions or second primaries.

Head and neck tumors are classified according to the TNM system of the American Joint Committee on Cancer. This classification varies according to the specific anatomic subsite (Tables 32-1 and 32-2). Distant metastases are found in <10% of patients at initial diagnosis, but in autopsy series, microscopic involvement of the lungs, bones, or liver is more common, particularly in patients with advanced neck lymph node disease. Modern imaging techniques may increase the number of patients with clinically detectable distant metastases in the future.

In patients with lymph node involvement and no visible primary, the diagnosis should be made by lymph node excision. If the results indicate squamous cell carcinoma, a panendoscopy should be performed, with biopsy of all suspicious-appearing areas and directed biopsies of common primary sites, such as the nasopharynx, tonsil, tongue base, and pyriform sinus.

## **Rx Treatment:** **HEAD AND NECK CANCER**

Patients with head and neck cancer can be categorized into three clinical groups: those with localized disease, those with locally or regionally advanced disease, and

those with recurrent and/or metastatic disease. Comorbidities associated with tobacco and alcohol abuse can affect treatment outcome and define long-term risks for patients who are cured of their disease.

**LOCALIZED DISEASE** Nearly a third of patients have localized disease; that is, T1 or T2 (stage I or stage II) lesions without detectable lymph node involvement or distant metastases. These lesions are treated with curative intent by surgery or radiation therapy. The choice of modality differs according to anatomic location and institutional expertise. Radiation therapy is often preferred for laryngeal cancer to preserve voice function, and surgery is preferred for small lesions in the oral cavity to avoid the long-term complications of radiation, such as xerostomia and dental decay. Overall 5-year survival is 60–90%. Most recurrences occur within the first 2 years following diagnosis and are usually local.

**LOCALLY OR REGIONALLY ADVANCED DISEASE** Locally or regionally advanced disease—disease with a large primary tumor and/or lymph node metastases—is the stage of presentation for >50% of patients. Such patients can also be treated with curative intent, but not with surgery or radiation therapy alone. Combined modality therapy including surgery, radiation therapy, and chemotherapy is most successful. Concomitant chemotherapy and radiation therapy appears to be the most effective approach. It can be administered either as a primary treatment for patients with unresectable disease, to pursue an organ preserving approach, or in the postoperative setting for intermediate-stage resectable tumors.

**Induction Chemotherapy** In this strategy, patients receive chemotherapy [usually cisplatin and fluorouracil (5-FU)] before surgery and radiation therapy. Most patients who receive three cycles show tumor reduction, and the response is clinically “complete” in up to half. This “sequential” multimodality therapy allows for organ preservation in patients with laryngeal and hypopharyngeal cancer, and it has been shown to result in higher cure rates compared with radiotherapy alone when drug combinations including cisplatin, 5-FU, and a taxane are used.

**Concomitant Chemoradiotherapy** With the concomitant strategy, chemotherapy and radiation therapy are given simultaneously rather than sequentially. Because most patients with head and neck cancer develop recurrent disease in the head and neck area, this approach is aimed at killing radiation-resistant cancer cells with chemotherapy. In addition, chemotherapy can enhance cell killing by radiation therapy. Toxicity (especially mucositis, grade 3 or 4 in 70–80%) is increased with concomitant chemoradiotherapy. However, meta-analyses of randomized trials document an

## TNM CLASSIFICATION FOR HEAD AND NECK CANCER (EXCEPT NASOPHARYNGEAL)

## Primary Tumor Site

T Grade	Oropharynx	Hypopharynx
T1	0–2 cm	0–2 cm
T2	2.1–4 cm	>1 site, 2–4 cm
T3	>4 cm	>4 cm
T4a	Larynx, muscle of tongue, medial pterygoid, hard palate, mandible invasion	Thyroid/cricoid cartilage, hyoid bone, thyroid gland, esophagus, or central compartment soft tissue invasion
T4b	Lateral pterygoid muscle, pterygoid plates, lateral nasopharynx, or skull base or encases carotid artery invasion	Invasion of prevertebral fascia, encases carotid artery, or involves mediastinal structures

## Regional Lymph Nodes (N)

NX	Regional lymph nodes cannot be assessed
N0	No regional lymph node metastasis
N1	Unilateral metastasis in lymph node(s), ≤6 cm in greatest dimension, above the supraclavicular fossa
N2	Bilateral metastasis in lymph node(s), ≤6 cm in greatest dimension, above the supraclavicular fossa
N3	Metastasis in a lymph node(s) >6 cm and/or to supraclavicular fossa
	N3a >6 cm
	N3b Extension to the supraclavicular fossa
MX	Distant metastasis cannot be assessed
M0	No distant metastasis
M1	Distant metastasis

## Stage Grouping

Stage 0	Tis	N0	M0
Stage I	T1	N0	M0
Stage II	T2	N0	M0
Stage III	T3	N0	M0
	T1	N1	M0
	T2	N1	M0
	T3	N1	M0
Stage IVA	T4a	N0	M0
	T4a	N1	M0
	T1	N2	M0
	T2	N2	M0
	T3	N2	M0
	T4a	N2	M0
Stage IVB	T4b	Any N	M0
	Any T	N3	M0
Stage IVC	Any T	Any N	M1

improvement in 5-year survival of 8% with concomitant chemotherapy and radiation therapy. Results seem even more favorable when more active combinations of drugs are used but have not yet been validated in randomized trials. Five-year survival is 34–50%. In addition, concomitant chemoradiotherapy produces better laryngectomy-free survival (organ preservation) than radiation therapy alone in patients with advanced larynx cancer. The use of radiation therapy together with cisplatin has produced markedly improved survival in patients with advanced nasopharyngeal cancer.

The success of concomitant chemoradiotherapy in patients with unresectable disease has led to the testing of a similar approach in patients with resected disease as a postoperative therapy. Concomitant chemoradiotherapy produces a significant improvement over postoperative radiation therapy alone for patients whose tumors demonstrate higher risk features, such as spread beyond nodes, involvement of multiple lymph nodes, or positive margins following surgery.

Monoclonal antibody to the EGFR (cetuximab) increases survival rates when administered during radiotherapy.

TABLE 32-2

## DEFINITION OF TNM–NASOPHARYNX

PRIMARY TUMOR (T)		STAGE GROUPING			
TX	Cannot be assessed	Stage 0	Tis	N0	M0
T0	No evidence	Stage I	T1	N0	M0
Tis	Carcinoma in situ	Stage IIA	T2a	N0	M0
T1	Tumor confined to the nasopharynx	Stage IIB	T1	N1	M0
T2	Tumor extends to soft tissues		T2	N1	M0
	T2a Tumor extends to the oropharynx and/or nasal cavity w/o parapharyngeal extension		T2a	N1	M0
	T2b Any tumor with parapharyngeal extension		T2b	N1	M0
T3	Tumor involves bony structures and/or paranasal sinuses		T2b	N1	M0
T4	Tumor with intracranial extension and/or involvement of cranial nerves, infratemporal fossa, hypopharynx, orbit, or masticator space	Stage III	T1	N2	M0
			T2a	N2	M0
	Regional Lymph Nodes (N)		T2b	N2	M0
	The distribution and the prognostic impact of regional lymph node spread from nasopharynx cancer, particularly of the undifferentiated type, are different from those of other head and neck mucosal cancers and justify the use of a different N classification scheme.		T3	N0	M0
	NX Regional lymph nodes cannot be assessed		T3	N1	M0
	N0 No regional lymph node metastasis		T3	N2	M0
	N1 Unilateral metastasis in lymph node(s), ≤6 cm in greatest dimension, above the supraclavicular fossa		T4	N0	M0
	N2 Bilateral metastasis in lymph node(s), ≤6 cm in greatest dimension, above the supraclavicular fossa		T4	N1	M0
	N3 Metastasis in lymph node(s), >6 cm and/or to supraclavicular fossa		T4	N2	M0
	N3a Greater than 6 cm in dimension		Any T	N3	M0
	N3b Extension to the supraclavicular fossa		Any T	Any N	M1

EGFR blockade results in radiation sensitization and has milder side effects than traditional chemotherapy agents. The integration of cetuximab into current standard chemoradiotherapy regimens is under investigation.

#### RECURRENT AND/OR METASTATIC DISEASE

Ten percent of patients present with metastatic disease, and over half of patients with locoregionally advanced disease have recurrence, 20% outside the head and neck region. Patients with recurrent and/or metastatic disease are, with few exceptions, treated with palliative intent. Some patients may require local or regional radiation therapy for pain control, but most are given chemotherapy. Response rates to chemotherapy average only 30–50%; the duration of response averages only 3 months, and the median survival time is 6–8 months. Therefore, chemotherapy provides transient symptomatic benefit. Drugs with single-agent activity in this setting include methotrexate, 5-FU, cisplatin, paclitaxel, and docetaxel. Combinations of cisplatin with 5-FU, carboplatin with 5-FU, and cisplatin or carboplatin with paclitaxel or docetaxel are frequently used.

EGFR-directed therapies, including monoclonal antibodies (e.g., cetuximab) and tyrosine kinase inhibitors (TKI) of the EGFR signaling pathway (e.g., erlotinib or gefitinib)

have single-agent activity of ~10%. Side effects are usually limited to an acneiform rash and diarrhea (for the TKIs). Their impact on survival times when combined with traditional agents or in combination with other novel agents such as antiangiogenic compounds is under investigation.

#### CHEMOPREVENTION

β-Carotene and *cis*-retinoic acid can lead to the regression of leukoplakia. However, *cis*-retinoic acid does not reduce the incidence of second primaries.

#### TREATMENT COMPLICATIONS

Complications from treatment of head and neck cancer are usually correlated to the extent of surgery and exposure of normal tissue structures to radiation. Currently, the extent of surgery has been limited or completely replaced by chemotherapy and radiation therapy as the primary approach. Acute complications of radiation include mucositis and dysphagia. Long-term complications include xerostomia, loss of taste, decreased tongue mobility, second malignancies, dysphagia, and neck fibrosis. The

438 complications of chemotherapy vary with the regimen used but usually include myelosuppression, mucositis, nausea and vomiting, and nephrotoxicity (with cisplatin).

The mucosal side effects of therapy can lead to malnutrition and dehydration. Many centers address issues of dentition before starting treatment, and some place feeding tubes to assure control of hydration and nutrition intake. About 50% of patients develop hypothyroidism from the treatment; thus thyroid function should be monitored.

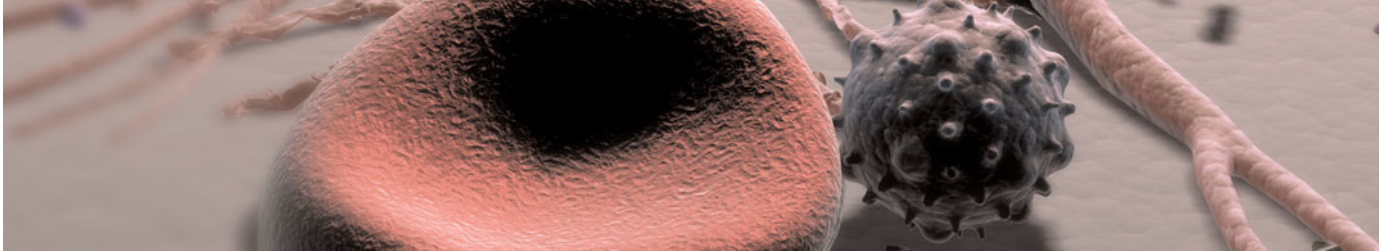
## SALIVARY GLAND TUMORS

Most benign salivary gland tumors are treated with surgical excision, and patients with invasive salivary gland tumors are treated with surgery and radiation therapy. Neutron radiation may be particularly effective. These tumors may recur regionally; adenoidcystic carcinoma has a tendency to recur along the nerve tracks. Distant metastases may occur as late as 10–20 years after the initial diagnosis. For metastatic disease, therapy is given with palliative intent, usually chemotherapy with doxorubicin and/or cisplatin.

## FURTHER READINGS

- ADELSTEIN DJ et al: An intergroup phase III comparison of standard radiation therapy and two schedules of concurrent chemoradiotherapy in patients with unresectable squamous cell head and neck cancer. *J Clin Oncol* 21:92, 2003
- BERNIER J et al: Postoperative irradiation with or without concomitant chemotherapy for locally advanced head and neck cancer. *N Engl J Med* 350:1945, 2004

- et al: Molecular therapy in head and neck oncology. *Nat Rev Clin Oncol* 6:266, 2009
- BONNER JA et al: Radiotherapy plus cetuximab for squamous-cell carcinoma of the head and neck. *N Engl J Med* 354:567, 2006
- BROCKSTEIN B, VOKES EE: Concurrent chemoradiotherapy for head and neck cancer. *Semin Oncol* 31:786, 2004
- COHEN EE et al: The expanding role of systemic therapy in head and neck cancer. *J Clin Oncol* 22:1743, 2004
- FORASTIERE AA et al: Concurrent chemotherapy and radiotherapy for organ preservation in advanced laryngeal cancer. *N Engl J Med* 349:2091, 2003
- GRANT DG et al: Complications following gastrostomy tube insertion in patients with head and neck cancer: A prospective multi-institution study, systematic review, and meta-analysis. *Clin Otolaryngol* 34:103, 2009
- KELLOFF GJ et al: Early detection of oral neoplasia: Watching with new eyes. *Cancer Prev Res* 2:405, 2009
- PFISTER DG et al: American Society of Clinical Oncology clinical practice guideline for the use of larynx-preservation strategies in the treatment of laryngeal cancer. *J Clin Oncol* 24:3693, 2006
- SEIWERT TY et al: The chemoradiation paradigm in head and neck cancer. *Nat Clin Pract Oncol* 4:145, 2007
- SLEBOS RJ et al: Gene expression differences associated with human papillomavirus status in head and neck squamous cell carcinoma. *Clin Cancer Res* 12:701, 2006
- VAN DER MOLEN L et al: Functional outcomes and rehabilitation strategies in patients treated with chemoradiotherapy for advanced head and neck cancer; a systematic review. *Eur Arch Otorhinolaryngol* 266:901, 2009
- VOKES E et al: Weekly carboplatin and paclitaxel followed by concomitant TFHX chemoradiotherapy: Curative and organ preserving therapy for advanced head and neck cancer. *J Clin Oncol* 21:320, 2003




## CHAPTER 33

# NEOPLASMS OF THE LUNG

John D. Minna ■ Joan H. Schiller

■ The Magnitude of the Problem . . . . .	.439	Staging of Small Cell Lung Cancer . . . . .	.448
■ Pathology . . . . .	.439	Resectability and Operability . . . . .	.449
■ Etiology . . . . .	.441	■ Lung Cancer Prevention . . . . .	.456
Biology and Molecular Pathogenesis . . . . .	.441	■ Benign Lung Neoplasms . . . . .	.456
■ Clinical Manifestations . . . . .	.443	Bronchial Adenomas . . . . .	.457
■ Diagnosis and Staging . . . . .	.444	Carcinoid and Other Neuroendocrine	
Screening . . . . .	.444	Lung Tumors . . . . .	.457
Establishing a Diagnosis of Lung Cancer . . . . .	.445	Hamartomas . . . . .	.457
Staging Patients with Lung Cancer . . . . .	.445	■ Metastatic Pulmonary Tumors . . . . .	.457
Lung Cancer Staging Procedures . . . . .	.445	■ Further Readings . . . . .	.458

### THE MAGNITUDE OF THE PROBLEM

 In 2007, primary carcinoma of the lung affected 114,760 males and 98,620 females in the United States; 86% die within 5 years of diagnosis, making it the leading cause of cancer death in both men and women. The incidence of lung cancer peaks between ages 55 and 65 years. Lung cancer accounts for 29% of all cancer deaths (31% in men, 26% in women). Lung cancer is responsible for more deaths in the United States each year than breast cancer, colon cancer, and prostate cancer combined; more women die each year of lung cancer than of breast cancer. The age-adjusted lung cancer death rate in males is decreasing, but in females it is stable or still increasing. These death rates are related to smoking; smoking cessation efforts begun 40 years ago in men are largely responsible for the change in incidence and death rates. However, women started smoking in substantial numbers about 10–15 years later than men; smoking cessation efforts need to increase for women. The 5-year overall lung cancer survival rate (15%) has nearly doubled in the past 30 years. The improvement is due to advances in combined-modality treatment with surgery, radiotherapy, and chemotherapy. The International Agency for Research on Cancer estimates that there will be >1.18 million deaths from lung cancer worldwide in 2007, which will rise to 10 million

deaths per year by 2030. This represents one lung cancer case for every 3 million cigarettes smoked. Thus primary carcinoma of the lung is a major health problem with a generally grim prognosis.

### PATHOLOGY

The term *lung cancer* is used for tumors arising from the respiratory epithelium (bronchi, bronchioles, and alveoli). Mesotheliomas, lymphomas, and stromal tumors (sarcomas) are distinct from epithelial lung cancer. Four major cell types make up 88% of all primary lung neoplasms according to the World Health Organization classification (**Table 33-1**). These are *squamous* or *epidermoid carcinoma*, *small cell* (also called *oat cell carcinoma*), *adenocarcinoma* (including bronchioloalveolar), and *large cell carcinoma*. The remainder include undifferentiated carcinomas, carcinoids, bronchial gland tumors (including adenoid cystic carcinomas and mucoepidermoid tumors), and rarer tumor types. The various cell types have different natural histories and responses to therapy, and thus a correct histologic diagnosis by an experienced pathologist is the first step to correct treatment. In the past 25 years, adenocarcinoma has replaced squamous cell carcinoma as the most frequent histologic subtype, and the incidence of small cell carcinoma is on the decline.



**FREQUENCY, AGE-ADJUSTED INCIDENCE, AND SURVIVAL RATES FOR DIFFERENT HISTOLOGIC TYPES OF LUNG CANCER<sup>a</sup>**

HISTOLOGIC TYPE OF THORACIC MALIGNANCY	FREQUENCY, %	AGE-ADJUSTED RATE	5-YEAR SURVIVAL RATE (ALL STAGES)
Adenocarcinoma (and all subtypes)	32	17	17
Bronchioloalveolar carcinoma	3	1.4	42
Squamous cell (epidermoid) carcinoma	29	15	15
Small cell carcinoma	18	9	5
Large cell carcinoma	9	5	11
Carcinoid	1.0	0.5	83
Mucoepidermoid carcinoma	0.1	<0.1	39
Adenoid cystic carcinoma	<0.1	<0.1	48
Sarcoma and other soft tissue tumors	0.1	0.1	30
All others and unspecified carcinomas	<u>11.0</u>	<u>6</u>	<u>NA</u>
<b>Total</b>	100	52	14

<sup>a</sup>Data on histology frequency and age-adjusted incidence rates per 100,000 U.S. population are from 60,514 cases of invasive lung cancer involving all races and both sexes obtained from the data for 1983–1987 of the Surveillance, Epidemiology, and End Results (SEER) Program of the National Cancer Institute; 5-year relative survival rates for all stages, all races, and both sexes are from the SEER data on 87,128 carcinomas, 1978–1986. NA, not available.

**Source:** Summarized from Travis et al: Cancer 75:191, 1995.

Major treatment decisions are made on the basis of whether a tumor is classified as a small cell lung carcinoma (SCLC) or as one of the non-small cell lung cancer (NSCLC) varieties (squamous, adenocarcinoma, large cell carcinoma, bronchioloalveolar carcinoma, and mixed versions of these). The histologic distinctions between SCLC and NSCLC include the following: SCLC has scant cytoplasm, small hyperchromatic nuclei with fine chromatin pattern and indistinct nucleoli with diffuse sheets of cells, whereas NSCLC has abundant cytoplasm, pleomorphic nuclei with coarse chromatin pattern, prominent nucleoli, and glandular or squamous architecture. Among the molecular distinctions, SCLC displays neuroendocrine properties absent in NSCLCs, production of specific peptide hormones [such as adrenocorticotrophic hormone (ACTH), arginine vasopressin (AVP), atrial natriuretic factor (ANF), gastrin-releasing peptide (GRP)] and differences in oncogene and tumor-suppressor gene changes (SCLCs have *RB* mutations in 90% and *p16* abnormalities in 10% but never have *KRAS* or *EGFR* mutations, whereas NSCLCs have *RB* mutations in only 20%, *p16* changes in 50%, *KRAS* mutations in 30%, and *EGFR* mutations in ~10%). Both types have frequent *p53* mutations (>70% in SCLC and >50% in NSCLC), 3p allele loss (>90% in both), telomerase expression (>90% in both), and tumor-acquired promoter methylation in multiple genes (>80% in both, often involving the same genes, including *RASSF1A*). SCLCs are initially very responsive to combination chemotherapy (>70% responses, with 30% complete responses) and to radiotherapy (>90% responses); however, most SCLCs ultimately relapse. By contrast, NSCLCs have objective tumor shrinkage following radiotherapy in 30–50% of cases and response to

combination chemotherapy in 20–35% of cases. At presentation, SCLCs usually have already spread such that surgery is unlikely to be curative and, given their responsiveness to chemotherapy, are managed primarily by chemotherapy with or without radiotherapy. Chemotherapy clearly provides symptom relief and survival advantage. By contrast, NSCLCs that are clinically localized at the time of presentation may be cured with either surgery or radiotherapy. The beneficial role of chemotherapy in NSCLC is in palliation of symptoms and improving survival modestly.

Although it is important to differentiate whether a tumor is SCLC or NSCLC for both prognostic and therapeutic reasons, it is less important to identify the histologic subtypes of NSCLC. Stage for stage, the histology of NSCLC is not an important prognostic factor, and in the past the different subtypes of NSCLC were rarely treated differently. However, lung adenocarcinomas (often with bronchioloalveolar features) may be responsive to therapy aimed at the epidermal growth factor receptor (EGFR) (see later). In addition, patients with squamous cell carcinoma may not be appropriate candidates for antiangiogenic therapy due to an increased risk of bleeding (see later).

Eighty-five percent of patients with lung cancer of all histologic types are current or former cigarette smokers. Of the annual 213,380 new cases of lung cancer, ~50% develop in former smokers. With increased success in smoking cessation efforts, the number of former smokers will grow, and these individuals will be important candidates for early detection and chemoprevention efforts.

All histologic types of lung cancer are due to smoking. However, lung cancer can also occur in individuals who have never smoked. By far the most common form

of lung cancer arising in lifetime nonsmokers, in women, and in young patients (<45 years) is adenocarcinoma. However, in nonsmokers with adenocarcinoma involving the lung, the possibility of other primary sites should be considered. Squamous and small cell cancers usually present as central masses with endobronchial growth, whereas adenocarcinomas and large cell cancers tend to present as peripheral nodules or masses, frequently with pleural involvement. Squamous and large cell cancers cavitate in 10–20% of cases. Bronchioloalveolar carcinoma (BAC) is a subtype of adenocarcinoma that grows along the alveoli without invasion and can present radiographically as a single mass; as a diffuse, multinodular lesion; as a fluffy infiltrate; and on screening CT scans as a “ground-glass” opacity. The male to female ratio is 1:1, and although BAC can be associated with smoking, it is often found in nonsmokers. Histologically pure BAC is relatively rare. More common is adenocarcinoma with BAC features. BAC may present in a mucinous form, which tends to be multicentric, and a nonmucinous form, which tends to be solitary. Many of the EGFR mutations found in nonsmoking lung cancers occur in adenocarcinomas with BAC histologic features.

## ETIOLOGY

Most lung cancers are caused by carcinogens and tumor promoters inhaled via cigarette smoking. The prevalence of smoking in the United States is 28% for males and 25% for females,  $\geq 18$  years or older; 38% of high school seniors smoke. The relative risk of developing lung cancer is increased  $\sim 13$ -fold by active smoking and  $\sim 1.5$ -fold by long-term passive exposure to cigarette smoke. Chronic obstructive pulmonary disease, which is also smoking-related, further increases the risk of developing lung cancer. The lung cancer death rate is related to the total amount (often expressed in “cigarette pack-years”) of cigarettes smoked, such that the risk is increased 60- to 70-fold for a man smoking two packs a day for 20 years as compared with a nonsmoker. Conversely, the chance of developing lung cancer decreases with cessation of smoking but may never return to the nonsmoker level. The increase in lung cancer rate in women is also associated with a rise in cigarette smoking. Women have a higher relative risk per given exposure than men ( $\sim 1.5$ -fold higher). This sex difference may be due to a greater susceptibility to tobacco carcinogens in women, although the data are controversial.

About 15% of lung cancers occur in individuals who have never smoked. Most of these are found in women. The reason for this sex difference is not known but may be related to hormonal factors.

Efforts to get people to stop smoking are mandatory. However, smoking cessation is extremely difficult because the smoking habit represents a powerful addiction to

nicotine. Smoking addiction is both biologic and psychosocial. Different methods are available to help motivated smokers give up the habit, including counseling, behavioral therapy, nicotine replacement (gum, patch, sublingual spray, inhaler), and antidepressants (such as bupropion). However, 1 year after starting such smoking cessation aids, the methods are successful in only 20–25% of individuals. Preventing people from starting to smoke is thus very important, and this primary prevention effort needs to be targeted to children because most cigarette smoking addiction occurs during the teenage years.

Radiation is another environmental cause of lung cancer. People exposed to high levels of radon or receiving thoracic radiation therapy have a higher than normal incidence of lung cancer, particularly if they smoke.

## BIOLOGY AND MOLECULAR PATHOGENESIS

Molecular genetic studies have shown the acquisition by lung cancer cells of a number of genetic lesions, including activation of dominant oncogenes and inactivation of tumor-suppressor or recessive oncogenes (Chaps. 23 and 24). In fact, lung cancer cells may have to accumulate a large number (perhaps  $\geq 20$ ) of such lesions. A small subpopulation (perhaps  $< 1\%$ ) of cells within a tumor are responsible for the full malignant behavior of the tumor; these are referred to as *cancer stem cells*. As part of this concept, the large bulk of the cells in a cancer are “offspring” of these cancer stem cells and, although clonally related to the cancer stem cell subpopulation, by themselves cannot regenerate the full malignant phenotype such as metastatic disease and unlimited replicative potential. These cancer stem cells are very important to identify because successful treatment of the tumor will require eradication of this stem cell component. These cancer stem cells may be more resistant to chemotherapy than the bulk of the tumor. Features that distinguish cancer stem cells from the remaining tumor cells have not been defined and validated.

### Activation of Dominant Oncogenes

Changes in dominant oncogenes include point mutations in the coding regions of the *RAS* family of oncogenes (particularly in the *KRAS* gene in adenocarcinoma of the lung); mutations in the tyrosine kinase domain of the EGFR found in adenocarcinomas from nonsmokers ( $\sim 10\%$  in the United States with rates  $> 50\%$  in nonsmoking East Asian patients); occasional mutations in *BRAF* and *PIK3CA* or activation of the PIK3CA/AKT/mTor pathway; amplification, rearrangement, and/or loss of transcriptional control of *myc* family oncogenes (*c-*, *N-*, and *L-myc*; changes in *c-myc* are found in non-small cell cancers, whereas changes in all *myc* family members are found in SCLC); overexpression of *bcl-2* and other antiapoptotic proteins; overexpression of other EGFR family

442 members such as Her-2/neu and ERBB3; and activated expression of the telomerase gene in >90% of lung cancers. Genome-wide approaches are identifying other amplified or mutated dominant oncogenes that could be important new therapeutic targets.

### **Inactivation of Tumor-Suppressor Genes**

A large number of tumor-suppressor genes (recessive oncogenes) have been identified that are inactivated during the pathogenesis of lung cancer. This usually occurs by a tumor-acquired inactivating mutation of one allele [seen, for example, in the *p53* and retinoblastoma (*RB*) tumor-suppressor gene] or tumor-acquired inactivation of expression by tumor-acquired promoter DNA methylation (seen, for example, in the case of the *p16* and *RASSF1A* tumor-suppressor genes), which is then coupled with physical loss of the other parental allele (“loss of heterozygosity”). This leaves the tumor cell with only the functionally inactive allele and thus loss of function of the growth-regulatory tumor-suppressor gene. Genome-wide approaches have identified many such genes involved in lung cancer pathogenesis, including *p53*, *RB*, *RASSF1A*, *SEMA3B*, *SEMA3F*, *FUS1*, *p16*, *LKB1*, *RAR $\beta$* , and *FHIT*. Several tumor-suppressor genes on chromosome 3p appear to be involved in nearly all lung cancers. Allelic loss for this region occurs very early in lung cancer pathogenesis, including in histologically normal smoking-damaged lung epithelium.

### **Autocrine Growth Factors**

The large number of genetic and epigenetic lesions shows that lung cancer, like other common epithelial malignancies, arises as a multistep process that is likely to involve both carcinogens causing mutation (“initiation”) and tumor promoters. Prevention can be directed at both processes. Lung cancer cells produce many peptide hormones and express receptors for these hormones. They can promote tumor cell growth in an “autocrine” fashion.

Highly carcinogenic derivatives of nicotine are formed in cigarette smoke. Lung cancer cells of all histologic types (and the cells from which they are derived) express nicotinic acetylcholine receptors. Nicotine activates signaling pathways in tumor and normal cells that block apoptosis. Thus nicotine itself could be directly involved in lung cancer pathogenesis both as a mutagen and tumor promoter.

### **Inherited Predisposition to Lung Cancer**

Although an inherited predisposition to develop lung cancer is not common, several features suggest a potential for familial association. People with inherited mutations in *RB* (patients with retinoblastomas living to

adulthood) and *p53* (Li-Fraumeni syndrome) genes may develop lung cancer. First-degree relatives of lung cancer probands have a two- to threefold excess risk of lung cancer or other cancers, many of which are not smoking-related. An as yet unidentified gene in chromosome region 6q23 was found to segregate in families at high risk of developing lung cancer of all histologic types. Finally, certain polymorphisms of the P450 enzyme system (which metabolizes carcinogens) or chromosome fragility (*mutagen sensitivity*) genotypes are associated with the development of lung cancer. The use of any of these inherited differences to identify persons at very high risk of developing lung cancer would be useful in early detection and prevention efforts.

### **Therapy Targeted at Molecular Abnormalities**

A detailed understanding of the molecular pathogenesis should be applicable to new methods of early diagnosis, prevention, and treatment of lung cancer. Two examples of this translation involve EGFR and vascular endothelial growth factor (VEGF). EGFR belongs to the ERBB (HER) family of protooncogenes, including EGFR (ERBB1), Her2/neu (ERBB2), HER3 (ERBB3), and HER4 (ERBB4), cell-surface receptors consisting of an extracellular ligand-binding domain, a transmembrane structure, and an intracellular tyrosine kinase (TK) domain. The binding of ligand to receptor activates receptor dimerization and TK autophosphorylation, initiating a cascade of intracellular events, leading to increased cell proliferation, angiogenesis, metastasis, and a decrease in apoptosis (Chap. 24). Overexpression of EGFR protein or amplification of the *EGFR* gene has been found in as many as 70% of NSCLCs.

Activating/oncogenic mutations (usually a missense or a small deletion mutation) in the TK domain of EGFR have been identified. These are found most commonly in women, East Asians, patients who have never smoked, and those with adenocarcinoma and BAC histology. This is also the group of patients who are most likely to have dramatic responses to drugs that inhibit TK activation [tyrosine kinase inhibitors (TKIs)]. EGFR mutations are almost never found in cancers other than lung cancer, nor in lung cancers that have *KRAS* mutations. These EGFR mutations, often associated with amplification of the *EGFR* gene, usually confer sensitivity of these lung cancers to EGFR TKIs (such as gefitinib or erlotinib), resulting in clinically beneficial tumor responses that unfortunately are still not permanent. In many cases the development of EGFR TKI resistance is associated with the development of another mutation in the *EGFR* gene (*T790M* mutation), or amplification of the *c-met* oncogene. However, other drugs with EGFR TKI activity are in development to which the lung cancers with these resistance mutations will respond as are drugs targeting *c-met* or its pathways.

The discovery of EGFR mutation/amplification driving lung cancer growth and the dramatic response of these tumors to oral EGFR TKI therapy has prompted a widespread search for other drugs “targeted” against oncogenic changes in lung cancer. An important example of another such target is VEGF, which, although not mutated, is inappropriately produced by lung cancers and stimulates tumor angiogenesis (Chap. 24). VEGF is often overexpressed in lung cancer, and the resulting increase in tumor microvessel density correlates with poor prognosis. A monoclonal antibody to the VEGF ligand, bevacizumab, has significant antitumor effects when used with chemotherapy in lung cancer (see later).

### **Molecular Profiles Predict Survival and Response**

Just as the presence of EGFR TK domain mutations and amplification is an excellent predictor of response to EGFR TKIs, molecular predictors of response to standard chemotherapy and other new targeted agents are being sought. Lung cancers can be molecularly typed at the time of diagnosis to yield information that predicts survival and defines agents to which the tumor is most likely to respond. One example is the identification of alterations in lung cancer DNA repair pathways that may predict resistance to chemotherapy. Patients whose tumors exhibit low activity of the excision-repair-cross complementation group 1 (ERCC1) proteins typically have a worse prognosis because they are unable to repair DNA adducts in the tumor. However, retrospective analysis shows that when treated with cisplatin, patients with tumors expressing low levels of ERCC1 activity appear to do better because they are unable to repair DNA adducts caused by cisplatin, whereas patients with high ERCC1 activity actually do worse with cisplatin-based chemotherapy. Although these protein or gene expression “signatures” have yet to be validated in large prospective studies, it is possible that such information will allow future therapy to be tailored to the characteristics of each patient’s tumor. Mass spectroscopy-based proteomic studies have identified unique protein patterns in the serum of patients, one of which allows for early diagnosis while another can predict sensitivity or resistance to drugs. However, such methods have not been validated and may be difficult to implement in a patient care setting.

### **CLINICAL MANIFESTATIONS**

Lung cancer gives rise to signs and symptoms caused by local tumor growth, invasion or obstruction of adjacent structures, growth in regional nodes through lymphatic spread, growth in distant metastatic sites after hematogenous dissemination, and remote effects of tumor products (paraneoplastic syndromes) (Chaps. 49 and 50).

Although 5–15% of patients with lung cancer are identified while they are asymptomatic, usually as a result of a routine chest radiograph or through the use of screening CT scans, most patients present with some sign or symptom. Central or endobronchial growth of the primary tumor may cause cough, hemoptysis, wheeze and stridor, dyspnea, and postobstructive pneumonitis (fever and productive cough). Peripheral growth of the primary tumor may cause pain from pleural or chest wall involvement, dyspnea on a restrictive basis, and symptoms of lung abscess resulting from tumor cavitation. Regional spread of tumor in the thorax (by contiguous growth or by metastasis to regional lymph nodes) may cause tracheal obstruction, esophageal compression with dysphagia, recurrent laryngeal nerve paralysis with hoarseness, phrenic nerve paralysis with elevation of the hemidiaphragm and dyspnea, and sympathetic nerve paralysis with Horner’s syndrome (enophthalmos, ptosis, miosis, and ipsilateral loss of sweating). Malignant pleural effusion often leads to dyspnea. *Pancoast’s* (or *superior sulcus tumor*) *syndrome* results from local extension of a tumor growing in the apex of the lung with involvement of the eighth cervical and first and second thoracic nerves, with shoulder pain that characteristically radiates in the ulnar distribution of the arm, often with radiologic destruction of the first and second ribs. Often Horner’s syndrome and Pancoast’s syndrome coexist. Other problems of regional spread include *superior vena cava syndrome* from vascular obstruction; pericardial and cardiac extension with resultant tamponade, arrhythmia, or cardiac failure; lymphatic obstruction with resultant pleural effusion; and lymphangitic spread through the lungs with hypoxemia and dyspnea. In addition, BAC can spread transbronchially, producing tumor growing along multiple alveolar surfaces with impairment of gas exchange, respiratory insufficiency, dyspnea, hypoxemia, and sputum production.

*Extrathoracic metastatic disease* is found at autopsy in >50% of patients with squamous carcinoma, 80% of patients with adenocarcinoma and large cell carcinoma, and >95% of patients with small cell cancer. Lung cancer metastases may occur in virtually every organ system. Common clinical problems related to metastatic lung cancer include brain metastases with headache, nausea, and neurologic deficits; bone metastases with pain and pathologic fractures; bone marrow invasion with cytopenias or leukoerythroblastosis; liver metastases causing liver dysfunction, biliary obstruction, anorexia, and pain; lymph node metastases in the supraclavicular region and occasionally in the axilla and groin; and spinal cord compression syndromes from epidural or bone metastases. Adrenal metastases are common but rarely cause adrenal insufficiency.

*Paraneoplastic syndromes* are common in patients with lung cancer and may be the presenting finding or first sign of recurrence. In addition, paraneoplastic syndromes

may mimic metastatic disease and, unless detected, lead to inappropriate palliative rather than curative treatment. Often the paraneoplastic syndrome may be relieved with successful treatment of the tumor. In some cases, the pathophysiology of the paraneoplastic syndrome is known, particularly when a hormone with biologic activity is secreted by a tumor (Chap. 49). However, in many cases the pathophysiology is unknown. Systemic symptoms of anorexia, cachexia, weight loss (seen in 30% of patients), fever, and suppressed immunity are paraneoplastic syndromes of unknown etiology. *Endocrine syndromes* are seen in 12% of patients: hypercalcemia and hypophosphatemia resulting from the ectopic production by squamous tumors of parathyroid hormone (PTH) or, more commonly, PTH-related peptide; hyponatremia with the syndrome of inappropriate secretion of antidiuretic hormone or possibly atrial natriuretic factor by small cell cancer; and ectopic secretion of ACTH by small cell cancer. ACTH secretion usually results in additional electrolyte disturbances, especially hypokalemia, rather than the changes in body habitus that occur in Cushing's syndrome from a pituitary adenoma.

*Skeletal-connective tissue syndromes* include clubbing in 30% of cases (usually non-small cell carcinomas) and hypertrophic pulmonary osteoarthropathy in 1–10% of cases (usually adenocarcinomas), with periostitis and clubbing causing pain, tenderness, and swelling over the affected bones and a positive bone scan. *Neurologic-myoapathic syndromes* are seen in only 1% of patients but are dramatic and include the myasthenic *Eaton-Lambert syndrome* and retinal blindness with small cell cancer; peripheral neuropathies, subacute cerebellar degeneration, cortical degeneration, and polymyositis are seen with all lung cancer types. Many of these are caused by autoimmune responses such as the development of anti-voltage-gated calcium channel antibodies in the Eaton-Lambert syndrome (Chap. 50). Coagulation, thrombotic, or other hematologic manifestations occur in 1–8% of patients and include migratory venous thrombophlebitis (*Trousseau's syndrome*), nonbacterial thrombotic (marantic) endocarditis with arterial emboli, disseminated intravascular coagulation with hemorrhage, anemia, granulocytosis, and leukoerythroblastosis. Thrombotic disease complicating cancer is usually a poor prognostic sign. Cutaneous manifestations such as dermatomyositis and acanthosis nigricans are uncommon (1%), as are the renal manifestations of nephrotic syndrome or glomerulonephritis ( $\leq 1\%$ ).

## DIAGNOSIS AND STAGING

### SCREENING

Most patients with lung cancer present with advanced disease, raising the question of whether screening would detect these tumors at an earlier stage when they are theoretically more curable. The role of screening high-risk

patients (e.g., current or former smokers  $>50$  years of age) for early stage lung cancers is debated. Results from five randomized screening studies in the 1980s of chest x-rays with or without cytologic analysis of sputum did not show any impact on lung cancer-specific mortality from screening high-risk patients, although earlier-stage cancers were detected in the screened groups. These studies have been criticized for their design and statistical analyses, but they led to current recommendations not to use these tools to screen for lung cancer. However, low-dose, noncontrast, thin-slice, helical, or spiral CT has emerged as a possible new tool for lung cancer screening. Spiral CT is a scan in which only the pulmonary parenchyma is examined, thus negating the use of intravenous contrast and the necessity of a physician being present at the examination. The scan can usually be done quickly (within one breath) and involves low doses of radiation. In a nonrandomized study of current and former smokers from the Early Lung Cancer Action Project (ELCAP), low-dose CT was shown to be more sensitive than chest x-ray for detecting lung nodules and lung cancer in early stages. Survival from date of diagnosis is also long (10-year survival predicted to be 92% in screening-detected stage I NSCLC patients). Other nonrandomized CT screening studies of asymptomatic current or former smokers also found that early lung cancer cases were diagnosed more often with CT screening than predicted by standard incidence data. However, no decline in the number of advanced lung cancer cases or deaths from lung cancer was noted in the screened group. Thus spiral CT appears to diagnose more lung cancer without improving lung cancer mortality. Concerns include the influence of lead-time bias, length-time bias, and overdiagnosis (cancers so slow-growing that they are unlikely to cause the death of the patient). Overdiagnosis is a well-established problem in prostate cancer screening, but it is surprising that some lung cancers are not fatal. However, many of the small adenocarcinomas found as "ground-glass" opacities on screening CT appear to have such long doubling times ( $>400$  days) that they may never harm the patient. Although CT screening will detect lung cancer in 1–4% of the patients screened over a 5-year period, it also detects a substantial number of false-positive lung lesions (ranging from 25–75% in different series) that need follow-up and evaluation. The appropriate management of these small lesions is undefined. Unnecessary treatment of these patients may include thoracotomy and lung resection, thus adding to the cost, mortality, and morbidity of treatment. A large randomized trial of CT screening for lung cancer (National Lung Cancer Screening Trial) involving ~55,000 individuals has completed accrual and will provide definitive data in the next several years on whether screening reduces lung cancer mortality. Until these results become available, routine CT screening for lung cancer cannot be recommended for any risk group. For

those patients who want to be screened, physicians need to discuss the possible benefits and risks of such screening, including the risk of false-positive scans that could result in multiple follow-up CTs and possible biopsies for a malignancy that may not be life-threatening.

## ESTABLISHING A DIAGNOSIS OF LUNG CANCER

Once signs, symptoms, or screening studies suggest lung cancer, a tissue diagnosis must be established. Tumor tissue can be obtained by a bronchial or transbronchial biopsy during fiberoptic bronchoscopy; by node biopsy during mediastinoscopy; from the operative specimen at the time of definitive surgical resection; by percutaneous biopsy of an enlarged lymph node, soft tissue mass, lytic bone lesion, bone marrow, or pleural lesion; by fine-needle aspiration of thoracic or extrathoracic tumor masses using CT guidance; or from an adequate cell block obtained from a malignant pleural effusion. In most cases, the pathologist should be able to make a definite diagnosis of epithelial malignancy and distinguish small cell from non-small cell lung cancer.

## STAGING PATIENTS WITH LUNG CANCER

Lung cancer staging consists of two parts: first, a determination of the location of tumor (anatomic staging) and, second, an assessment of a patient's ability to withstand various antitumor treatments (physiologic staging). In a patient with NSCLC, *resectability* (whether the tumor can be entirely removed by a standard surgical procedure such as a lobectomy or pneumonectomy), which depends on the anatomic stage of the tumor, and *operability* (whether the patient can tolerate such a surgical procedure), which depends on the cardiopulmonary function of the patient, are determined.

### Non-Small Cell Lung Cancer

The TNM International Staging System should be used for cases of NSCLC, particularly in preparing patients for curative attempts with surgery or radiotherapy (Table 33-2). The various T (tumor size), N (regional node involvement), and M (presence or absence of distant metastasis) factors are combined to form different stage groups. At presentation, approximately a third of patients have disease localized enough for a curative attempt with surgery or radiotherapy (patients with stage I or II disease and some with stage IIIA disease), a third have distant metastatic disease (stage IV disease), and a third have local or regional disease that may or may not be amenable to a curative attempt (some patients with stage IIIA disease and others with stage IIIB disease) (see later). This staging system provides useful prognostic information.

### Small Cell Lung Cancer

A simple two-stage system is used. In this system, *limited-stage disease* (seen in ~30% of all patients with SCLC) is defined as disease confined to one hemithorax and regional lymph nodes (including mediastinal, contralateral hilar, and usually ipsilateral supraclavicular nodes), whereas *extensive-stage disease* (seen in ~70% of patients) is defined as disease exceeding those boundaries. Clinical studies such as physical examination, x-rays, CT and bone scans, and bone marrow examination are used in staging. In part, the definition of limited-stage disease relates to whether the known tumor can be encompassed within a tolerable radiation therapy port. Thus contralateral supraclavicular nodes, recurrent laryngeal nerve involvement, and superior vena caval obstruction can all be part of limited-stage disease. However, cardiac tamponade, malignant pleural effusion, and bilateral pulmonary parenchymal involvement generally qualify disease as extensive stage because the organs within a curative radiation therapy port cannot safely tolerate curative radiation doses.

## LUNG CANCER STAGING PROCEDURES

(Table 33-3) All patients with lung cancer should have a complete history and physical examination, with evaluation of all other medical problems, determination of performance status and history of weight loss, and a CT scan of the chest and abdomen with contrast. Positron emission tomography (PET) scans are sensitive in detecting both intrathoracic and metastatic disease. PET is useful in assessing the mediastinum and solitary pulmonary nodules. A standardized uptake value (SUV) of  $>2.5$  is highly suspicious for malignancy.

False negatives can be seen in diabetes, in slow-growing tumors such as BAC, in concurrent infection such as tuberculosis, and in lesions  $<8$  mm. False positives can also be seen in infections and granulomatous disease. Thus PET should never be used alone to diagnose lung cancer, mediastinal involvement, or metastases. Instead, its primary function is to help guide a mediastinal biopsy for staging purposes and to help identify sites of metastatic disease. Fiberoptic bronchoscopy obtains material for pathologic examination and information on tumor size, location, degree of bronchial obstruction (i.e., assesses resectability), and recurrence.

Chest radiographs and CT scans are needed to evaluate tumor size and nodal involvement; old radiographs are useful for comparison. CT scans of the thorax and upper abdomen are of use in the preoperative staging of NSCLC to detect mediastinal nodes and pleural extension and occult abdominal disease (e.g., liver, adrenal) and in planning curative radiation therapy. However, mediastinal nodal involvement should be documented histologically if the findings will influence therapeutic decisions. Thus sampling of lymph nodes

## TUMOR, NODE, METASTASIS INTERNATIONAL STAGING SYSTEM FOR LUNG CANCER

5-YEAR SURVIVAL RATE, %

STAGE	TNM DESCRIPTORS	CLINICAL STAGE	SURGICAL-PATHOLOGIC STAGE
IA	T1 N0 M0	61	67
IB	T2 N0 M0	38	57
IIA	T1 N1 M0	34	55
IIB	T2 N1 M0	24	39
IIB	T3 N0 M0	22	38
IIIA	T3 N1 M0	9	25
IIIB	T1–2–3 N2 M0	13	23
	T4 N0–1–2 M0	7	<5
	T1–2–3–4 N3 M0	3	<3
IV	Any T any N M1	1	<1
<b>Tumor (T) Status Descriptor</b>			
T0	No evidence of a primary tumor		
TX	Primary tumor cannot be assessed, or tumor proven by the presence of malignant cells in sputum or bronchial washings but not visualized by imaging or bronchoscopy		
TIS	Carcinoma in situ		
T1	Tumor <3 cm in greatest dimension, surrounded by lung or visceral pleura, without bronchoscopic evidence of invasion more proximal than lobar bronchus (i.e., not in main bronchus)		
T2	Tumor with any of following: >3 cm in greatest dimension; involves main bronchus, ≥2 cm distal to the carina; invades visceral pleura; associated with atelectasis or obstructive pneumonitis extending to hilum but does not involve entire lung		
T3	Tumor of any size that directly invades any of the following: chest wall (including superior sulcus tumors), diaphragm, mediastinal pleura, parietal pericardium; or tumor in main bronchus <2 cm distal to carina but without involvement of carina; or associated atelectasis or obstructive pneumonitis of entire lung		
T4	Tumor of any size that invades any of the following: mediastinum, heart, great vessels, trachea, esophagus, vertebral body, carina; or tumor with a malignant pleural or pericardial effusion, <sup>a</sup> or with satellite tumor nodule(s) within the ipsilateral primary-tumor lobe of the lung.		
<b>Lymph Node (N) Involvement Descriptor</b>			
NX	Regional lymph nodes cannot be assessed		
N0	No regional lymph node metastasis		
N1	Metastasis to ipsilateral peribronchial and/or ipsilateral hilar lymph nodes, and intrapulmonary nodes involved by direct extension of the primary tumor		
N2	Metastasis to ipsilateral mediastinal and/or subcarinal lymph node(s)		
N3	Metastasis to contralateral mediastinal, contralateral hilar, ipsilateral or contralateral scalene, or supraclavicular lymph node(s)		
<b>Distant Metastasis (M) Descriptor</b>			
MX	Presence of distant metastasis cannot be assessed		
M0	No distant metastasis		
M1	Distant metastasis present <sup>b</sup>		

<sup>a</sup>Most pleural effusions associated with lung cancer are due to tumor. However, in a few patients with multiple negative cytopathologic exams of a nonbloody, nonexudative pleural or pericardial effusion that clinical judgment dictates is not related to the tumor, the effusion should be excluded as a staging element and the patient's disease staged as T1, T2, or T3.

<sup>b</sup>Separate metastatic pulmonary tumor nodule(s) in the ipsilateral nonprimary tumor lobe(s) of the lung are classified as M1.

**Source:** Adapted from CF Mountain. Revisions in the International System for Staging of Lung Cancer. Chest 111:1710, 1997; with permission.

via mediastinoscopy or thoracotomy to establish the presence or absence of N2 or N3 nodal involvement is crucial in considering a curative surgical approach for patients with NSCLC with clinical stage I, II, or III disease, regardless of whether the PET is positive or negative. A preoperative mediastinoscopy may not need

to be done in patients with normal-size nodes (by CT) that are PET-negative because the discovery of micrometastases is unlikely to change the preoperative management of the disease, although lymph node sampling should be done intraoperatively. A standard nomenclature for referring to the location of lymph

TABLE 33-3

## PRETREATMENT STAGING PROCEDURES FOR PATIENTS WITH LUNG CANCER

**All Patients**

Complete history and physical examination  
 Determination of performance status and weight loss  
 Complete blood count with platelet determination  
 Measurement of serum electrolytes, glucose, and calcium; renal and liver function tests  
 Electrocardiogram  
 Skin test for tuberculosis  
 Chest x-ray  
 CT scan of chest and abdomen  
 CT or MRI scan of brain and radionuclide scan of bone if any finding suggests the presence of tumor metastasis in these organs  
 Fiberoptic bronchoscopy with washings, brushings, and biopsy of suspicious lesions unless medically contraindicated or if it would not alter therapy (e.g., very late stage patient)  
 X-rays of suspicious bony lesions detected by scan or symptom  
 Barium swallow radiographic examination if esophageal symptoms exist  
 Pulmonary function studies and arterial blood gas measurements if signs or symptoms of respiratory insufficiency are present  
 Biopsy of accessible lesions suspicious for cancer if a histologic diagnosis is not yet made or if treatment or staging decisions would be based on whether or not a lesion contained cancer

**Patients with Non-Small Cell Lung Cancer Who Have No Contraindication<sup>a</sup> to Curative Surgery or Radiotherapy with or without Chemotherapy**

All the above procedures, plus the following:  
 PET scan to evaluate mediastinum and detect metastatic disease  
 Pulmonary function tests and arterial blood gas measurements  
 Coagulation tests  
 CT or MRI scan of brain if symptoms suggestive  
 Cardiopulmonary exercise testing if performance status or pulmonary function tests are borderline  
 If surgical resection is planned: surgical evaluation of the mediastinum at mediastinoscopy or at thoracotomy  
 If the patient is a poor surgical risk or a candidate for curative radiotherapy: transthoracic fine-needle aspiration biopsy or transbronchial forceps biopsy of peripheral lesions if material from routine fiberoptic bronchoscopy is negative

**Patients Presenting with Small Cell or Advanced Non-Small Cell Lung Cancer**

For proven small cell lung cancer, all the procedures under “All Patients,” plus the following:  
 CT or MRI scan of brain  
 Bone marrow aspiration and biopsy (if peripheral blood counts abnormal)  
 For non-small cell lung cancer or cancer of unknown histology, all the procedures under “All Patients,” plus the following:  
 Fiberoptic bronchoscopy if indicated by hemoptysis, obstruction, pneumonitis, or no histologic diagnosis of cancer  
 Biopsy of accessible lesions suspicious for tumor to obtain a histologic diagnosis or if therapy would be altered by finding of tumor  
 Transthoracic fine-needle aspiration biopsy or transbronchial forceps biopsy of peripheral lesions if fiberoptic bronchoscopy is negative and no other material exists for a histologic diagnosis  
 Diagnostic and therapeutic thoracentesis if a pleural effusion is present

<sup>a</sup>Patients with non-small cell lung cancer and extrathoracic metastatic disease, malignant pleural effusion, or intrathoracic disease beyond the bounds of a tolerable radiotherapy port.

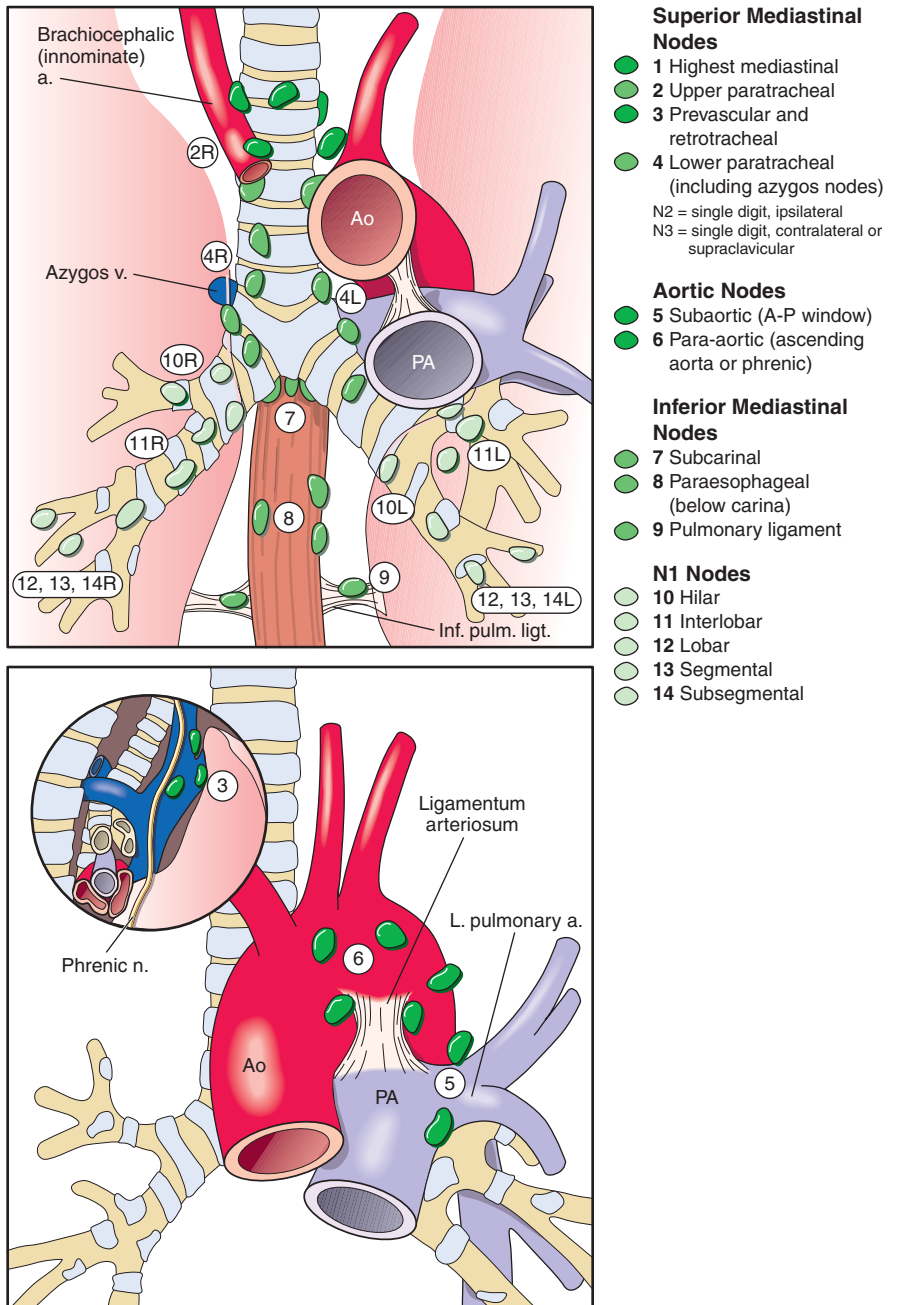
**Note:** CT, computed tomography; PET, positron emission tomography.

nodes involved with cancer has evolved (**Fig. 33-1**). Unless the CT-detected abnormalities are unequivocal, histology of suspicious extrathoracic lesions should be confirmed by procedures such as fine-needle aspiration if the patient would otherwise be considered for curative treatment. In SCLC, CT scans are used in the planning of chest radiation treatment and in the assessment of the response to chemotherapy and radiation therapy.

Surgery or radiotherapy can make interpretation of conventional chest x-rays difficult; after treatment, CT scans can provide good evidence of tumor recurrence.

If signs or symptoms suggest involvement by tumor, brain CT or bone scans are performed, as well as radiography of any suspicious bony lesions. Any accessible lesions suspicious for cancer should be biopsied if involvement would influence treatment.





**FIGURE 33-1**  
Regional lymph node stations for lung cancer staging. (Used by permission from CF Mountain, C Dresler: *Chest* 111:1718,

In patients presenting with a mass lesion on chest x-ray or CT scan and no obvious contraindications to a curative approach after the initial evaluation, the mediastinum must be investigated. Approaches vary among centers and include performing chest CT scan and mediastinoscopy (for right-sided tumors) or mediastinotomy (for left-sided lesions) on all patients and proceeding directly to thoracotomy for staging of the mediastinum. Patients who present with disease that is confined to the chest but not resectable, and who thus are candidates for neoadjuvant chemotherapy plus surgery or for curative radiotherapy with or without chemotherapy, should have additional tests done as indicated to evaluate specific symptoms. In patients presenting with NSCLC that is not curable, all the general

staging procedures are done, plus fiberoptic bronchoscopy as indicated to evaluate hemoptysis, obstruction, or pneumonitis, as well as thoracentesis with cytologic examination (and chest tube drainage as indicated) if fluid is present. As a rule, a radiographic finding of an isolated lesion (such as an enlarged adrenal gland) should be confirmed as cancer by fine-needle aspiration before a curative attempt is rejected.

### STAGING OF SMALL CELL LUNG CANCER

Pretreatment staging for patients with SCLC includes the initial general lung cancer evaluation with chest and abdominal CT scans (because of the high frequency of hepatic and adrenal involvement) as well as fiberoptic

bronchoscopy with washings and biopsies to determine the tumor extent before therapy; brain CT scan (10% of patients have metastases); and radionuclide scans (bone) if symptoms or other findings suggest disease involvement in these areas. Bone marrow biopsies and aspirations are rarely performed given the low incidence of isolated bone marrow metastases. Chest and abdominal CT scans are very useful to evaluate and follow tumor response to therapy, and chest CT scans are helpful in planning chest radiotherapy ports.

If signs or symptoms of spinal cord compression or leptomeningitis develop at any time in lung cancer patients with disease of any histologic type, a spinal CT scan or MRI scan and examination of the cerebrospinal fluid cytology are performed. If malignant cells are detected, radiotherapy to the site of compression and intrathecal chemotherapy (usually with methotrexate) are given. In addition, a brain CT or MRI scan is performed to search for brain metastases, which often are associated with spinal cord or leptomeningeal metastases.

## RESECTABILITY AND OPERABILITY

In patients with NSCLC, the following are major contraindications to curative surgery or radiotherapy alone: extrathoracic metastases; superior vena cava syndrome; vocal cord and, in most cases, phrenic nerve paralysis; malignant pleural effusion; cardiac tamponade; tumor within 2 cm of the carina (not curable by surgery but potentially curable by radiotherapy); metastasis to the contralateral lung; bilateral endobronchial tumor (potentially curable by radiotherapy); metastasis to the supraclavicular lymph nodes; contralateral mediastinal node metastases (potentially curable by radiotherapy); and involvement of the main pulmonary artery. Pleural effusions are generally considered malignant regardless of whether they are cytology positive, particularly if they are exudative, bloody, and have no other probable etiology. Most patients with SCLC have unresectable disease; however, if clinical findings suggest the potential for resection (most common with peripheral lesions), that option should be considered.

### Physiologic Staging

Patients with lung cancer often have cardiopulmonary and other problems related to chronic obstructive pulmonary disease as well as other medical problems. To improve their preoperative condition, correctable problems (e.g., anemia, electrolyte and fluid disorders, infections, and arrhythmias) should be addressed, smoking stopped, and appropriate chest physical therapy instituted. Because it is not always possible to predict whether a lobectomy or pneumonectomy will be required until the time of operation, a conservative approach is to restrict resectional surgery to patients who could potentially

tolerate a pneumonectomy. In addition to nonambulatory performance status, a myocardial infarction within the past 3 months is a contraindication to thoracic surgery because 20% of patients will die of reinfarction. An infarction in the past 6 months is a relative contraindication. Other major contraindications include uncontrolled major arrhythmias, an FEV<sub>1</sub> (forced expiratory volume in 1 s) <1 L, CO<sub>2</sub> retention (resting PCO<sub>2</sub> >45 mm Hg), DLCO <40%, and severe pulmonary hypertension. Recommending surgery when the FEV<sub>1</sub> is 1.1–2.0 L or <80% predicted requires careful judgment, whereas an FEV<sub>1</sub> >2.5 L or >80% predicted usually permits a pneumonectomy. In patients with borderline lung function but a resectable tumor, cardiopulmonary exercise testing could be performed as part of the physiologic evaluation. This test allows an estimate of the maximal oxygen consumption ( $\dot{V}_{O_2\max}$ ). A  $\dot{V}_{O_2\max}$  <15 mL/kg per minute predicts a high risk of postoperative complications.

### **Rx** Treatment: LUNG CANCER

The overall treatment approach to patients with lung cancer is shown in [Table 33-4](#). Patients should be encouraged to stop smoking, particularly if they will be undergoing surgery or radiation therapy. Those who do fare better than those who continue to smoke.

#### MANAGEMENT OF OCCULT AND STAGE 0 CARCINOMAS

In the uncommon situation where malignant cells are identified in a sputum or bronchial washing specimen but the chest radiograph appears normal (TX tumor stage), the lesion must be localized. More than 90% can be localized by meticulous examination of the bronchial tree with a fiberoptic bronchoscope under general anesthesia and collection of a series of differential brushings and biopsies. Carcinoma in situ or multicentric lesions are often found in these patients. Current recommendations are for the most conservative surgical resection, allowing removal of the cancer and conservation of lung parenchyma, even if the bronchial margins are positive for carcinoma in situ. The 5-year overall survival rate for these occult cancers is ~60%. Close follow-up of these patients is indicated because of the high incidence of second primary lung cancers (5% per patient per year). One approach to in situ or multicentric lesions uses systemically administered hematoporphyrin (which localizes to tumors and sensitizes them to light) followed by bronchoscopic phototherapy.

#### SOLITARY PULMONARY NODULE AND “GROUND-GLASS” OPACITY

Occasionally, when an x-ray or CT scan is done for another purpose, a patient presents with an incidental finding of an asymptomatic, solitary pulmonary nodule (SPN, defined as an x-ray density completely surrounded by normal aerated lung, with

## SUMMARY OF TREATMENT APPROACH TO PATIENTS WITH LUNG CANCER

**Non-Small Cell Lung Cancer**

Stages IA, IB, IIA, IIB, and some IIIA:

Surgical resection for stages IA, IB, IIA, and IIB

Surgical resection with complete-mediastinal lymph node dissection and consideration of neoadjuvant CRx for stage IIIA disease with “minimal N2 involvement” (discovered at thoracotomy or mediastinoscopy)

Consider postoperative RT for patients found to have N2 disease

Stage IB: discussion of risk/benefits of adjuvant CRx; not routinely given

Stage II: Adjuvant CRx

Curative potential RT for “nonoperable” patients

Stage IIIA with selected types of stage T3 tumors:

Tumors with chest wall invasion (T3): en bloc resection of tumor with involved chest wall and consideration of postoperative RT

Superior sulcus (Pancoast’s) (T3) tumors: preoperative RT (30–45 Gy) and CRx followed by en bloc resection of involved lung and chest wall with postoperative RT

Proximal airway involvement (<2 cm from carina) without mediastinal nodes: sleeve resection if possible preserving distal normal lung or pneumonectomy

Stages IIIA “advanced, bulky, clinically evident N2 disease” (discovered preoperatively) and IIIB disease that can be included in a tolerable RT port:

Curative potential concurrent RT + CRx if performance status and general medical condition are reasonable; otherwise, sequential CRx followed by RT, or RT alone

Stage IIIB disease with carinal invasion (T4) but without N2 involvement:

Consider pneumonectomy with tracheal sleeve resection with direct reanastomosis to contralateral mainstem bronchus

Stage IV and more advanced IIIB disease:

RT to symptomatic local sites

CRx for ambulatory patients; consider CRx and bevacizumab for selected patients

Chest tube drainage of large malignant pleural effusions

Consider resection of primary tumor and metastasis for isolated brain or adrenal metastases

**Small Cell Lung Cancer**

Limited stage (good performance status): combination CRx + concurrent chest RT

Extensive stage (good performance status): combination CRx

Complete tumor responders (all stages): consider prophylactic cranial RT

Poor-performance-status patients (all stages):

Modified-dose combination CRx

Palliative RT

**All Patients**

RT for brain metastases, spinal cord compression, weight-bearing lytic bony lesions, symptomatic local lesions (nerve paralyses, obstructed airway, hemoptysis, intrathoracic large venous obstruction, in non-small cell lung cancer and in small cell cancer not responding to CRx)

Appropriate diagnosis and treatment of other medical problems and supportive care during CRx

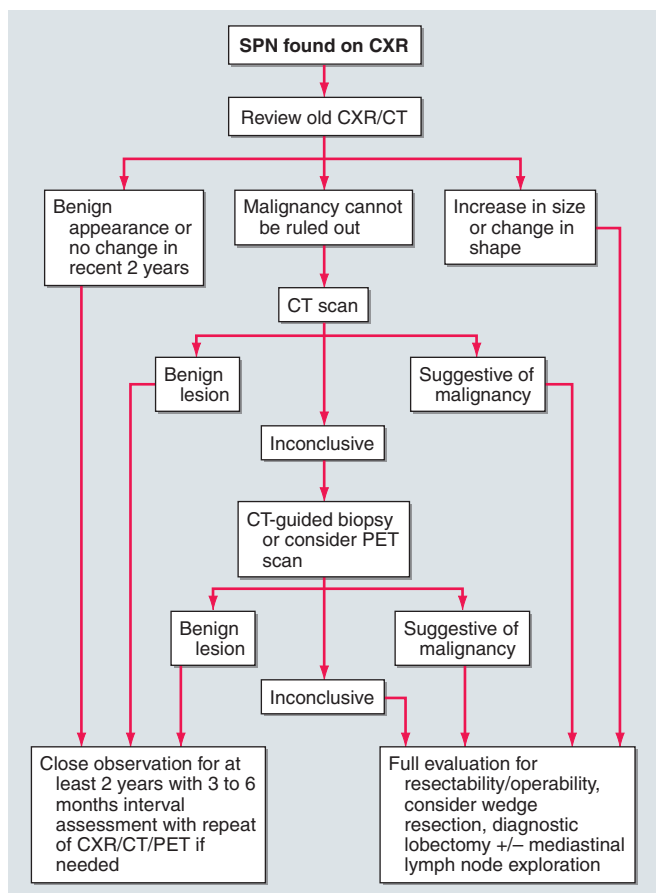
Encouragement to stop smoking

Entrance into clinical trial, if eligible

**Note:** CRx, chemotherapy; RT, radiotherapy.

circumscribed margins, of any shape, usually 1–6 cm in greatest diameter). A decision to resect or follow the nodule must be made. Nodules of this size discovered in CT screening for lung cancer would also be of the size requiring a biopsy for tissue. Approximately 35% of all such lesions in adults are malignant, most being primary lung cancer; <1% are malignant in nonsmokers <35 years of age. A complete history, including a smoking history, physical examination, routine laboratory tests, chest CT scan, fiberoptic bronchoscopy, and old chest x-rays or CT scans, are obtained if available.

PET scans are useful in detecting lung cancers >7–8 mm in diameter. If no diagnosis is immediately apparent, the following risk factors would all argue strongly in favor of proceeding with resection to establish a histologic diagnosis: a history of cigarette smoking; age  $\geq 35$  years; a relatively large lesion; lack of calcification; chest symptoms; associated atelectasis, pneumonitis, or adenopathy; growth of the lesion revealed by comparison with old x-rays/CT scans; or a positive PET scan. At present, only two radiographic criteria are reliable predictors of the benign nature of an



**FIGURE 33-2**

**Algorithm for evaluation of a solitary pulmonary nodule (SPN).** CT, computed tomography; CXR, chest x-ray; PET, positron emission tomography.

SPN: lack of growth over a period >2 years and certain characteristic patterns of calcification. Calcification alone does not exclude malignancy. However, a dense central nidus, multiple punctate foci, and “bull’s-eye” (granuloma) and “popcorn ball” (hamartoma) calcifications are all highly suggestive of a benign lesion. An algorithm for evaluating an SPN is shown in [Fig. 33-2](#).

When old x-rays are not available, the PET scan is negative, and the characteristic calcification patterns are absent, the following approach is reasonable. Nonsmoking patients <35 years can be followed with serial CT every 3 months for 1 year and then yearly; if any significant growth is found, a histologic diagnosis is needed. For patients >35 years and all patients with a smoking history, a histologic diagnosis must be made, regardless of whether the lesion is PET positive or negative, because slow-growing cancers such as BAC can be PET negative. The sample for histologic diagnosis can be obtained either at the time of nodule resection or, if the patient is a poor operative risk, via video-assisted thoracic surgery (VATS) or transthoracic fine-needle biopsy. Some institutions use preoperative fine-needle aspiration on all such

lesions; however, all positive lesions have to be resected, and negative cytologic findings in most cases have to be confirmed by histology on a resected specimen. Much has been made of sparing patients an operation; however, the high probability of finding a malignancy (particularly in smokers >35 years) and the excellent chance for surgical cure when the tumor is small both suggest an aggressive approach to these lesions.

Since the advent of screening CTs, small “ground-glass” opacities (GGOs) have often been observed, particularly because the increased sensitivity of CTs enables detection of smaller lesions. Many of these GGOs, when biopsied, are found to be BAC. Some of the GGOs are semiopaque and referred to as “partial” GGOs, which are often more slowly growing, with atypical adenomatous hyperplasia histology, a lesion of unclear prognostic significance. By contrast, “solid” GGOs have a faster growth rate and usually are typical adenocarcinomas histologically.

### NON-SMALL CELL LUNG CANCER NSCLC Stages I and II

**Surgery** In patients with NSCLC stages IA, IB, IIA and IIB (Table 33-2) who can tolerate an operation, the treatment of choice is pulmonary resection. If a complete resection is possible, the 5-year survival rate for N0 disease is ~60–80%, depending on the size of the tumor. The 5-year survival drops to ~50% when N1 (hilar node involvement) disease is present.

The extent of resection is a matter of surgical judgment based on findings at exploration. Clinical trials have shown that lobectomy is superior to wedge resection in reducing the rate of local recurrence. Pneumonectomy is reserved for patients with tumors involving multiple lobes or very central tumors and should only be performed in patients with excellent pulmonary reserve. In addition, patients undergoing a right-sided pneumonectomy after induction chemotherapy and radiation therapy (see later) have a high mortality rate and should be carefully selected before surgery. Wedge resection and segmentectomy (potentially by VATS) are reserved for patients with poor pulmonary reserve and small peripheral lesions.

**Radiotherapy with Curative Intent** Patients with stage I or II disease who refuse surgery or are not candidates for pulmonary resection should be considered for radiation therapy with curative intent. The decision to administer high-dose radiotherapy is based on the extent of disease and the volume of the chest that requires irradiation. Patients with distant metastases, malignant pleural effusion, or cardiac involvement are not considered candidates for curative radiation treatment. The long-term survival for patients with all stages of lung cancer who receive radiation with curative intent is ~20%. In addition to being potentially curative, radiotherapy may increase the quality and length of life

by controlling the primary tumor and preventing symptoms related to local recurrence in the lung.

Treatment with curative intent usually involves mid-plane doses of 60–64 Gy; palliative thoracic radiation (see later) involves delivery of 30–45 Gy. The major dose-limiting concern is the amount of lung parenchyma and other organs in the thorax that are included in the treatment plan, including the spinal cord, heart, and esophagus. In patients with a major degree of underlying pulmonary disease, the treatment plan may have to be compromised because of the deleterious effects of radiation on pulmonary function.

The most common side effect of curative thoracic radiation is esophagitis. Other side effects include fatigue, radiation myelitis (rare), and radiation pneumonitis, which can sometimes progress to pulmonary fibrosis. The risk of radiation pneumonitis is proportional to the radiation dose and the volume of lung in the field. The full clinical syndrome (dyspnea, fever, and radiographic infiltrate corresponding to the treatment port) occurs in 5% of cases and is treated with glucocorticoids. Acute radiation esophagitis occurs during treatment but is usually self-limited, unlike spinal cord injury, which may be permanent and should be avoided by careful treatment

planning. Brachytherapy (local radiotherapy delivered by placing radioactive “seeds” in a catheter in the tumor bed) provides a way to give a high local dose while sparing surrounding normal tissue.

**NSCLC Stage IA** Patients with resected stage IA NSCLC receive no other therapy but are at a high risk of recurrence (~2–3% annually) or developing a second primary lung cancer. Thus it is reasonable to follow these patients with CT scans for the first 5 years and consider entering them in to early detection and chemoprevention studies.

**Adjuvant Chemotherapy for NSCLC Stages IB and II** A meta-analysis of >4300 patients showed a trend toward improved survival of ~5% at 5 years with cisplatin-based adjuvant therapy ( $p = .08$ ). Subsequently, three randomized studies demonstrated no significant survival advantage despite the addition of more “modern” postoperative adjuvant chemotherapy regimens. However, since then at least three additional randomized trials and two meta-analyses showed a survival benefit in response to postoperative adjuvant-based therapy (Table 33-5). Consequently, adjuvant chemotherapy is now routinely recommended in NSCLC patients with a good performance status and stage IIA or IIB disease, although the beneficial effects are modest.

TABLE 33-5

RANDOMIZED STUDIES OF ADJUVANT CHEMOTHERAPY IN NSCLC						
STUDY	TREATMENT	NUMBER OF PATIENTS	5-YEAR SURVIVAL (%)	MEDIAN SURVIVAL	HAZARD RATIO (95% CI)	p VALUE
ECOG 3590 (II–IIIA)	Surgery → RT vs Surgery + post-op concurrent RT + cis/etoposide	242 246	39% 33%	39 months vs 38 months	0.93 (0.74–1.18)	0.56
ALPI (I–IIIA)	Surgery alone vs Surgery + post-op mitomycin/vindesine/cisplatin	603 606	51% 43%	NR	0.96 (0.8–1.1)	0.59
Big Lung Trial (I–IIIB)	Surgery alone vs Surgery + post-op chemotherapy <sup>a</sup>	189 192		33 months vs 34 months	1.02 (0.77–1.35)	0.90
IALT IB–IIIA	Surgery alone vs Surgery + post-op Cis + VP16/vinca	405 361	40% 44.5%	NR	0.86 (0.76–0.98)	<0.03
UFT IA–IB	Surgery alone vs Surgery + post-op UFT	488 469	85% 88%	—	0.71 (0.52–0.98)	0.04
CALGB IB (ASCO 06)	Surgery alone vs Surgery + post-op carbo/paclitaxel	172 172	57% 59%	78 months vs 95 months	0.80 (0.60–1.07)	0.10
NCI-C IB–II	Surgery alone vs Surgery + post-op Cis/vinorelbine	241 241	54% 69%	73 months vs 94 months	0.69 (0.52–0.91)	0.04
ANITA IB, II, IIIA	Surgery alone vs Surgery + post-op Cis/vinorelbine	433 407	43% 51%	44 months vs 66 months	0.79 (50–88.5)	0.017

<sup>a</sup>Chemotherapy allowed: mitomycin, cisplatin, ifosfamide; mitomycin, vinblastine, cisplatin; cisplatin, vindesine; cisplatin, vinorelbine.

**Note:** RT, radiation therapy; NR, not reported; UFT, tegafur and uracil.

The role of adjuvant chemotherapy for stage IB disease is undefined. Subset analysis of all the randomized studies showed no benefit in patients with stage IB. In addition, one clinical trial focusing solely on IB disease and using carboplatin and paclitaxel (one of the most commonly used regimens for advanced disease) found a hazard ratio of 0.80 (20% reduction in death with adjuvant chemotherapy) that was not statistically significant. Thus patients with stage IB NSCLC are not routinely given adjuvant therapy.

#### **Adjuvant Radiotherapy for NSCLC Stages I-II**

After apparent complete resection, postoperative adjuvant radiation therapy does not improve survival and may actually be detrimental to survival in N0 and N1 disease.

#### **Superior Sulcus or Pancoast Tumors**

Non-small cell carcinomas of the superior pulmonary sulcus producing *Pancoast's syndrome* appear to behave differently than lung cancers at other sites and are usually treated with combined radiotherapy and surgery. Patients with these carcinomas should have the usual preoperative staging procedures, including mediastinoscopy and CT and PET scans, to determine tumor extent and a neurologic examination (and sometimes nerve conduction studies) to document involvement or impingement of nerves in the region. If mediastinoscopy is negative, curative approaches may be used in treating Pancoast's syndrome despite its apparent locally invasive nature. The best results reported thus employed concurrent preoperative irradiation [30 Gy in 10 treatments] and cisplatin and etoposide, followed by an en bloc resection of the tumor and involved chest wall 3–6 weeks later; 65% of thoracotomy specimens showed either a complete response or minimal residual microscopic disease on pathologic evaluation. The 2-year survival rate was 55% for all eligible patients and 70% for patients who had a complete resection.

#### **NSCLC with T3, N0 Disease (Stage IIB)**

The subset of T3, N0 disease (which does not present as Pancoast's tumor) was initially considered stage III disease. However, it has a different natural history and treatment strategy than stage III N2 disease and is now considered as stage IIB. Patients with peripheral chest wall invasion should have resection of the involved ribs and underlying lung. Chest wall defects are then repaired with chest wall musculature or Marlex mesh and methylmethacrylate. Five-year survival rates as high as 35–50% have been found, and adjuvant chemotherapy is usually recommended.

**NSCLC Stage III** Treatment of locally advanced NSCLC is one of the most controversial issues in the management of lung cancer. Treatment options include a local

therapy (surgery or radiation therapy) combined with systemic chemotherapy to control micrometastases. Interpretation of the results of clinical trials involving patients with locally advanced disease has been clouded by a number of issues, including changing diagnostic techniques, different staging systems, and heterogeneous patient populations with tumors that range from nonbulky stage IIIA (clinical N1 nodes with N2 nodes discovered only at the time of surgery, despite a negative mediastinoscopy) to bulky N2 nodes (enlarged adenopathy clearly visible on chest x-rays or multiple nodal level involvement) to clearly inoperable stage IIIB disease. Thus a team approach involving pulmonary medicine, thoracic surgery, and medical and radiation oncology is essential for the management of these patients.

#### **NSCLC Stage IIIA**

**Nonbulky IIIA** Surgery for N2 disease is a controversial area in the management of lung cancer. Patients with N2 disease can be divided into "minimal" disease (involvement of only one node with microscopic foci, usually discovered at thoracotomy or mediastinoscopy) and the more common "advanced" bulky disease, clinically obvious on CT scans and discovered preoperatively. Patients who have an incidental finding of N2 disease at the time of resection should receive adjuvant chemotherapy.

**Bulky IIIA** No evidence suggests that patients with "bulky," multilevel ipsilateral mediastinal nodes (N2) have improved survival with surgery and either pre- or postoperative chemotherapy compared to treatment with chemotherapy plus radiation therapy. This important issue was addressed in the multicenter randomized Intergroup 0139 Trial involving patients with pathologically staged N2 disease who received 45 Gy of induction radiation therapy plus two cycles of cisplatin and etoposide to "debulk" tumors. The patients were then randomly assigned to surgical resection of any residual tumor or to boost radiation therapy plus an additional two cycles of chemotherapy. Although a significant improvement in progression-free survival was observed at 5 years for those patients randomized to surgical resection (22% vs 11%;  $p = 0.017$ ), the difference in 5-year overall survival while favoring surgery (22% vs 11%;  $p = 0.10$ ) was not significant. This is important because treatment-related mortality was greater in the surgery arm (8% vs 2%), with the majority of deaths occurring in patients undergoing pneumonectomy. Patients who had persistent N2 disease following neoadjuvant chemotherapy did particularly poorly, leading some oncologists to conclude that surgery for bulky IIIA disease should only be conducted in patients who have clearing of their mediastinal nodes following neoadjuvant therapy. The main role of neoadjuvant chemotherapy is to control micrometastatic disease,

and if this macroscopically evident disease is not sensitive to chemotherapy, it is unlikely that the microscopic disease will be controlled. Thus surgical removal of the primary tumor after such chemotherapy is probably fruitless. Likewise, neoadjuvant chemotherapy generally should not be used to render inoperable disease operable. One exception to this approach is T4, N0 or T4, N1 (stage IIIB, see later) disease for which preoperative chemotherapy may provide enough tumor debulking to allow otherwise unresectable disease to be resected. Chemotherapy may allow chest wall resection for direct extension of tumor, tracheal sleeve pneumonectomy, and sleeve lobectomy for lesions near the carina.

**Bulky NSCLC Stage IIIA and Dry IIIB (IIIB without a Pleural Effusion)** The presence of pathologically involved N2 nodes should be confirmed histologically because enlarged nodes detected by CT will be negative for cancer in ~30% of patients. Chemotherapy plus radiation therapy is the treatment of choice for patients with bulky stage IIIA or IIIB disease without pleural effusion (referred to as “dry IIIB”). Randomized studies demonstrate an improvement in median and long-term survival with chemotherapy followed by radiation therapy, compared with radiation therapy alone. Subsequent randomized trials have shown that administering chemotherapy and radiation therapy concurrently results in improved survival compared to sequential chemotherapy and radiation therapy, albeit with more side effects, such as fatigue, esophagitis, and neutropenia. Frequently, an additional two to three cycles of chemotherapy are also given. However, it is not clear whether these additional cycles should be administered before or after the chemoradiation, what the optimal drugs are, or whether doses should be attenuated during the radiation but given more frequently. (Lower doses of drugs may “sensitize” the tumor to radiation therapy but may not by themselves remove other microscopic disease.)

## DISSEMINATED NON-SMALL CELL LUNG CANCER

**Symptomatic Management of Metastatic Disease** Patients who present with or progress to metastatic NSCLC have a poor prognosis, as do patients with pleural effusions. Untreated, the median survival of both of these patient groups is roughly 4–6 months. They are often treated in the same way. Standard medical management, the judicious use of pain medications, the appropriate use of radiotherapy, and outpatient chemotherapy form the cornerstone of this management.

**Palliative Radiation Therapy** Patients whose primary tumor is causing urgent severe symptoms such as bronchial obstruction with pneumonitis, hemoptysis, upper airway or superior vena cava obstruction, brain or

spinal cord compression, or painful bony metastases should have radiotherapy to the primary tumor to relieve these symptoms. Usually, radiation therapy is given as a course of 30–40 Gy over 2–4 weeks for palliative purposes. Radiation therapy provides relief of intrathoracic symptoms: hemoptysis, 84%; superior vena cava syndrome, 80%; dyspnea, 60%; cough, 60%; atelectasis, 23%; and vocal cord paralysis, 6%. Cardiac tamponade (treated with pericardiocentesis and radiation therapy to the heart), painful bony metastases (with relief in 66%), brain or spinal cord compression, and brachial plexus involvement may also be palliated with radiotherapy.

*Brain metastases* are often isolated sites of relapse in patients with adenocarcinoma of the lung otherwise controlled by surgery or radiotherapy. These are usually treated with radiation therapy and, in highly selected cases, with surgical resection. Usually, in addition to radiotherapy for brain metastases and cord compression, dexamethasone (25–100 mg/d in four divided doses) is also given and then rapidly tapered to the lowest dosage that relieves symptoms. Because of the high frequency of brain metastases, the use of prophylactic cranial irradiation (PCI; given to the whole brain before metastatic disease becomes manifest) has been considered. However, PCI is of no proven value. Screening asymptomatic patients with head CT scans to find such lesions before such metastases become clinically evident is also not proven beneficial.

*Pleural effusions* are common and are usually treated with thoracentesis. If they recur and are symptomatic, a Pleurx catheter or chest tube drainage followed by pleurodesis with a sclerosing agent such as intrapleural talc, bleomycin, or tetracycline can be used. These sclerosing agents may be administered through the chest tube, or, in the case of talc, via thoroscopic insufflation. In the former case, the chest cavity is completely drained. Xylocaine 1% is instilled (15 mL), followed by 50 mL normal saline. Then the sclerosing agent is dissolved in 100 mL normal saline, and this solution is injected through the chest tube. The chest tube is clamped for 4 h if tolerated, and the patient is rotated onto different sides to distribute the sclerosing agent. The chest tube is removed 24–48 h later, after drainage has become slight (usually <100 mL/24 h). Although sclerosing agents have been widely used, an indwelling Pleurx catheter is equivalent to chest tube drainage and better tolerated by patients. In this situation, the Pleurx catheter is tunneled under the skin and can remain in place for weeks. The patient periodically drains the catheter into a specially designed bag, as needed.

*Symptomatic endobronchial lesions* that recur after surgery or radiotherapy or develop in patients with severely compromised pulmonary function are difficult to treat with conventional therapy. Neodymium-YAG (yttrium-aluminum-garnet) laser therapy administered

through a flexible fiberoptic bronchoscope (usually under general anesthesia) can provide palliation in 80–90% of such patients even when the tumor has relapsed after radiotherapy. Local radiotherapy delivered by brachytherapy, photodynamic therapy using a photosensitizing agent, and endobronchial stents are other measures that can relieve airway obstruction from recurrent tumor.

**Chemotherapy** Chemotherapy palliates symptoms, improves the quality of life, and improves survival in newly diagnosed patients with stage IV NSCLC, particularly in patients with good performance status. Whereas the median survival for untreated patients is roughly 4–6 months, and 1-year survival is 5–10%, with combination chemotherapy the median survival is 8–10 months, 1-year survival is 30–35%, and 2-year survival 10–15%. Combination chemotherapy produces an objective tumor response in 20–30% of patients, although the response is complete in <5%. In addition, economic analysis has found chemotherapy to be cost-effective palliation for stage IV NSCLC. However, the use of chemotherapy for NSCLC requires clinical experience and careful judgment to balance potential benefits and toxicities for these patients.

*Chemotherapy for previously untreated, good-performance-status patients* typically consists of two drugs (“doublets”). Traditionally, one of the two drugs has been either cisplatin or carboplatin, and the other drug is a taxane (paclitaxel or docetaxel), gemcitabine, or a vinca alkaloid such as vinorelbine. No major difference in outcome has been observed between the standard chemotherapy doublets, although they differ in terms of schedule, side effects, and cost. Cytotoxic chemotherapy for first-line chemotherapy is typically administered for four to six cycles; no benefit has been shown for continuing the same chemotherapy beyond that point. After four to six cycles, chemotherapy is usually stopped and the patient observed closely for tumor progression, at which point second-line chemotherapy may be started if the patient’s performance status remains good. Nausea with typical first-line regimens is usually mild, particularly when 5-HT<sub>3</sub> serotonin antagonists are used as antiemetics. Hair loss depends on the choice of regimen and should be discussed with the patient. All regimens cause myelosuppression, but the incidence of neutropenic fevers, bleeding episodes, or anemia requiring transfusions is low. Growth-factor support is rarely needed. Elderly patients without significant comorbid conditions benefit from and tolerate chemotherapy much the same as their younger counterparts. However, patients with a poorer performance status seem to obtain less benefit.

Docetaxel and pemetrexed are second-line agents for patients who have progressive disease on first-line

chemotherapy and still have a good performance status. Docetaxel improves progression-free survival and overall survival compared to best supportive care, and pemetrexed has roughly the same efficacy as docetaxel, but with fewer side effects.

**VEGF Targeted Therapy** Bevacizumab, a monoclonal antibody to VEGF, improves response rate, progression-free survival, and overall survival of patients with advanced disease when combined with chemotherapy (paclitaxel/carboplatin). Median, 1-year, and 2-year survival in response to chemotherapy plus bevacizumab was 12.3 months, 51%, and 23%, compared, respectively, to 10.3 months, 44%, and 15% with chemotherapy alone (hazard ratio: 0.79;  $p = 0.003$ ). A 1-year survival of >50% and a 2-year survival of >20% represents a significant improvement in long-term prognosis. The dose of bevacizumab administered on this trial was 15 mg/kg IV every 3 weeks. Bevacizumab side effects include bleeding, hypertension, and proteinuria, and the hemorrhagic side effects make this agent risky to use. Patients with squamous cancer cannot receive bevacizumab because of their tendency toward serious hemorrhagic side effects. Patients with brain metastases, hemoptysis, and bleeding disorders or who need anticoagulation are also not eligible to receive the agent. Despite these restrictions and careful patient selection, significant bleeding is noted in ~4% of patients.

**EGFR Targeted Therapy** Erlotinib is an oral inhibitor of the EGFR kinase that is used in second- and third-line therapy of NSCLC. Clinical responses have been seen in a large fraction of the small subset of patients with tumors bearing mutations in the EGFR. Prolonged survival with EGFR TKI treatment has also been observed in some patients whose tumors have amplification of the *EGFR* gene or overexpression of the receptor. Side effects of erlotinib differ from chemotherapy side effects of hair loss, nausea, and neutropenia, but they include acneiform skin rash and diarrhea. For patients whose tumors respond to EGFR TKI therapy, substantial clinical benefit is seen.

**SMALL CELL LUNG CANCER** SCLC is a chemotherapy-sensitive disease. Patients with limited stage disease have high response rates (60–80%) and a 10–30% complete response rate. The response rates in patients with extensive disease are somewhat lower (50%) and almost always partial responses. Tumor regressions usually occur quickly, within the first two cycles of treatment, and provide rapid palliation of tumor-related symptoms.

Chemotherapy significantly prolongs survival. Untreated, patients with limited-stage SCLC have a median survival of 12 weeks; the median survival with chemotherapy is 18 months, and long-term (>3 year) survival is 30–40%. The median survival of extensive-stage



patients is 9 months; <5% of patients survive 2 years. Thus, although initially responsive, most patients with SCLC relapse, presumably due to the emergence of chemotherapy resistance.

**Chemotherapy** The chemotherapy combination most widely used for SCLC is etoposide plus cisplatin or carboplatin, given every 3 weeks on an outpatient basis for four to six cycles. Increased dose intensity of chemotherapy adds toxicity without clear survival benefit. Appropriate supportive care (antiemetics, fluid support with cisplatin, monitoring of blood counts and blood chemistries, monitoring for signs of bleeding or infection, and, as required, use of hematopoietins) and adjustment of chemotherapy doses on the basis of nadir granulocyte counts are essential.

The prognosis of patients who relapse is poor. Patients who relapse >3 months since the completion of their initial chemotherapy (so-called chemosensitive disease) have a median survival of 4–5 months; patients who do not respond to initial chemotherapy or relapse within 3 months (chemorefractory disease) have a median survival of only 2–3 months. Patients with chemosensitive disease may be retreated with their initial regimen. Topotecan has modest activity as second-line therapy, or patients can be entered onto clinical trials testing new agents.

### Considerations for Therapy of SCLC Limited-Stage Disease

**Combined-Modality Chemoradiotherapy** Radiation therapy to the thorax is associated with a small but significant improvement in long-term survival for patients with limited-stage SCLC (5% at 3 years). Chemotherapy given concurrently with thoracic radiation is more effective than sequential chemoradiation but is associated with significantly more esophagitis and hematologic toxicity. In one randomized study, twice-daily hyperfractionated radiation was compared with a once-daily schedule; both were administered concurrently with four cycles of cisplatin and etoposide. Survival was significantly higher with the twice-daily regimen (median survival 23 months compared with 19 months; 5-year survival 26% compared with 16%), but the twice-daily regimen gave more grade 3 esophagitis and pulmonary toxicity. Patients should be carefully selected for concurrent chemoradiation therapy based on good performance status and pulmonary reserve.

PCI significantly decreases the development of brain metastases (which occur in about two-thirds of patients who do not receive PCI) and results in a small survival benefit (~5%) in patients who have obtained a complete response to induction chemotherapy. Deficits in cognitive ability following PCI are uncommon and often difficult to sort out from effects of chemotherapy or normal aging.

**Radiation Therapy for Palliation** Palliative radiation therapy is an important component of the management of SCLC patients. Cranial radiation often decreases the signs and symptoms of brain metastases. In the case of symptomatic, progressive lesions in the chest or at other critical sites, if radiotherapy has not yet been given to these areas, it may be administered in full doses (e.g., 40 Gy to the chest tumor mass).

**Surgery** Although surgical resection is not routinely recommended for SCLC, occasional patients meet the usual requirements for resectability (stage I or II disease with negative mediastinal nodes). Often this histologic diagnosis is made in some patients only on review of the resected surgical specimen. However, when such SCLC patients are discovered, they should receive standard SCLC chemotherapy. Retrospective series have reported high cure rates if postoperative chemotherapy is used, although it is unclear what the outcome would be with chemoradiation therapy alone, given the relatively low bulk disease of these patients.

## LUNG CANCER PREVENTION

Deterring children from taking up smoking and helping young adults stop is likely to be the most effective lung cancer prevention. Smoking cessation programs are successful in 5–20% of volunteers; the poor efficacy is due to the addictive nature of nicotine use, which is as strong as addiction to heroin.

Chemoprevention is an experimental approach to reduce lung cancer risk; no benefit has yet been shown for chemoprevention. Two putative chemoprevention agents, vitamin E and  $\beta$ -carotene, actually increased the risk of lung cancer in heavy smokers.

## BENIGN LUNG NEOPLASMS

The benign neoplasms of the lung, representing <5% of all primary tumors, include bronchial adenomas and hamartomas (90% of such lesions) and a group of very uncommon benign neoplasms (epithelial tumors such as bronchial papillomas, fibroepithelial polyps; mesenchymal tumors such as chondromas, fibromas, lipomas, hemangiomas, leiomyomas, pseudolymphomas; tumors of mixed origin such as teratomas; and other diseases such as endometriosis). The diagnostic and primary-treatment approach (surgery) is basically the same for all these neoplasms. They can present as central masses causing airway obstruction, cough, hemoptysis, and pneumonitis. The masses may or may not be visible on radiographs but are usually accessible to fiberoptic bronchoscopy. Alternatively, they can present without symptoms as SPNs and are evaluated accordingly. In all cases, the extent of

surgery must be determined at operation, and a conservative procedure with appropriate reconstructions is usually performed.

## BRONCHIAL ADENOMAS

Bronchial adenomas (80% are central) are slow-growing endobronchial lesions; they represent 50% of all benign pulmonary neoplasms. About 80–90% are carcinoids, 10–15% are adenocystic tumors (or cylindromas), and 2–3% are mucoepidermoid tumors. Adenomas present in patients 15–60 years old (average age 45) as endobronchial lesions and are often symptomatic for several years. Patients may have a chronic cough, recurrent hemoptysis, or obstruction with atelectasis, lobar collapse, or pneumonitis and abscess formation.

Bronchial adenomas of all types, because of their endobronchial and often central location, are usually visible by fiberoptic bronchoscopy. Because they are hypervascular, they can bleed profusely after bronchoscopic biopsy, and this problem should be anticipated. Bronchial adenomas must be considered as potentially malignant, thus requiring removal for symptom relief and because they can be locally invasive or recurrent, potentially can metastasize, and may produce paraneoplastic syndromes. Surgical excision is the primary treatment for all types of bronchial adenomas. The extent of surgery is determined at operation and should be as conservative as possible. Often bronchotomy with local excision, sleeve resection, segmental resection, or lobectomy is sufficient. Five-year survival rate after surgical resection is 95%, decreasing to 70% if regional nodes are involved. The treatment of metastatic pulmonary carcinoids is unclear because they can either be indolent or behave more like SCLC (Chap. 46). Assessment of the tempo and histology of the disease in the individual patient is necessary to determine if and when chemotherapy or radiotherapy is indicated.

## CARCINOID AND OTHER NEUROENDOCRINE LUNG TUMORS

Neuroendocrine lung tumors represent a spectrum of pathologic entities, including typical carcinoid, atypical carcinoid, and large cell neuroendocrine cancer, as well as SCLC. SCLC and large cell neuroendocrine cancer are high-grade neuroendocrine tumors and in general should be treated as described for SCLC. By contrast, typical carcinoid and atypical carcinoids are low- and intermediate-grade tumors with different treatment approaches and in general are resistant to chemotherapy. Carcinoids, like SCLCs, may secrete other hormones, such as ACTH or AVP, and can cause paraneoplastic syndromes that resolve on resection. Uncommonly, bronchial carcinoid metastases (usually to the liver) may produce the carcinoid syndrome, with cutaneous flush, bronchoconstriction,

diarrhea, and cardiac valvular lesions, which SCLC does not do. Carcinoid tumors that have an unusually aggressive histologic appearance (referred to as *atypical carcinoids*) metastasize in 70% of cases to regional nodes, liver, or bone, compared with only a 5% rate of metastasis for carcinoids with typical histology. Large cell neuroendocrine cancer is a high-grade NSCLC with neuroendocrine features. These tumors are characterized by histologic features similar to small cell cancer, but they are formed by larger cells. The prognosis for patients with large cell neuroendocrine cancer is significantly worse than that for patients with atypical carcinoid and classic large cell cancer. Five-year survival is 21% for patients with large cell neuroendocrine cancer, 65% for atypical carcinoid, and 90% for typical carcinoid.

## HAMARTOMAS

Pulmonary hamartomas have a peak incidence at age 60 and are more frequent in men than in women. Histologically, they contain normal pulmonary tissue components (smooth muscle and collagen) in a disorganized fashion. They are usually peripheral, clinically silent, and benign in their behavior. Unless the radiographic findings are pathognomonic for hamartoma, with “popcorn” calcification, the lesions usually have to be resected for diagnosis, particularly if the patient is a smoker. VATS may minimize the surgical complications.

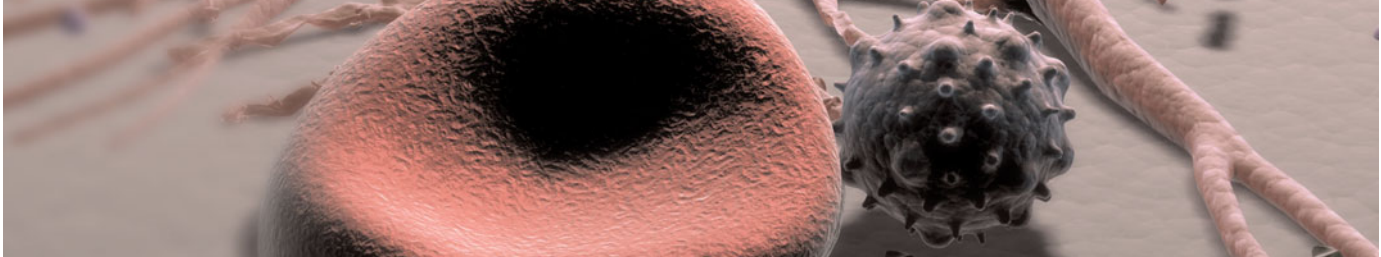
## METASTATIC PULMONARY TUMORS

The lung is a frequent site of metastases from primary cancers outside the lung. Usually such metastatic disease is incurable. However, two special situations should be borne in mind. The first is the development of an SPN or a mass on chest x-ray in a patient known to have an extrathoracic neoplasm. This nodule may represent a metastasis or a new primary lung cancer. Because the natural history of lung cancer is often worse than that of other primary tumors, a single pulmonary nodule in a patient with a known extrathoracic tumor is approached as though the nodule is a primary lung cancer, particularly if the patient is >35 years and a smoker. If a vigorous search for other sites of active cancer proves negative, the nodule is surgically resected. Second, in some cases multiple metastatic pulmonary nodules can be resected with curative intent. This tactic is usually recommended if, after careful staging, it is found that (1) the patient can tolerate the contemplated pulmonary resection, (2) the primary tumor has been definitively and successfully treated (disease-free for >1 year), and (3) all known metastatic disease can be encompassed by the projected pulmonary resection. Patients with uncontrolled primary tumors and other extrapulmonary metastases are not considered. Primary tumors whose pulmonary metastases

have been successfully resected for cure include osteogenic and soft tissue sarcomas; colon, rectal, uterine, cervix, and corpus tumors; head and neck, breast, testis, and salivary gland cancer; melanoma; and bladder and kidney tumors. Five-year survival rates of 20–30% have been found in selected series, and dramatic results have been achieved in patients with osteogenic sarcomas, where resection of pulmonary metastases (sometimes requiring several thoracotomies) is a standard curative treatment approach.

### FURTHER READINGS

- BESSE B, LE CHEVALIER T: Adjuvant or induction cisplatin-based chemotherapy for operable lung cancer. *Oncology* 23:520, 2009
- BLACK C et al: Population screening for lung cancer using computed tomography: Is there evidence of clinical effectiveness? A systematic review of the literature. *Thorax* 62:131, 2007
- DETTERBECK FC et al: The new lung cancer staging system. *Chest* 136:260, 2009
- DUBEY S, POWELL CA: Update in lung cancer. *Am J Respir Crit Care Med* 179:860, 2009
- EBERHARDT W et al: Chemoradiation paradigm for the treatment of lung cancer. *Nat Clin Pract Oncol* 3:188, 2006
- HAYES DN et al: Gene expression profiling reveals reproducible human lung adenocarcinoma subtypes in multiple independent patient cohorts. *J Clin Oncol* 24:5079, 2006
- HECHT SS et al: Chemoprevention of lung carcinogenesis in addicted smokers and ex-smokers. *Nat Rev Cancer* 9:476, 2009
- SANTOS ES et al: Gene expression profiling and non-small-cell lung cancer: Where are we now? *Clin Lung Cancer* 10:168, 2009
- SATO M et al: Molecular genetics of lung cancer and translation to the clinic. *J Thorac Oncol* 2:327, 2007
- STINNETT S et al: Role of chemotherapy for palliation in the lung cancer patient. *J Support Oncol* 5:19, 2007
- SUBRAMANIAN J, GOVINDAN R: Lung cancer in never smokers: A review. *J Clin Oncol* 25:561, 2007
- SUN S et al: Of molecules and cancer stem cells: Novel therapeutic strategies for lung cancer. *J Clin Invest* 117, 2007
- WRIGHT G et al: Surgery for non-small cell lung cancer: Systematic review and meta-analysis of randomised controlled trials. *Thorax* 61:597, 2006



# CHAPTER 34


## BREAST CANCER

Marc E. Lippman

Genetic Considerations . . . . .	.459
■ Epidemiology . . . . .	.460
■ Evaluation of Breast Masses in Men and Women . . . . .	.461
The Palpable Breast Mass . . . . .	.461
The Abnormal Mammogram . . . . .	.462
Breast Masses in the Pregnant or Lactating Woman . . . . .	.463
Benign Breast Masses . . . . .	.463
■ Screening . . . . .	.463
■ Staging . . . . .	.463
■ Follow-up of Breast cancer Patients . . . . .	.470
■ Further Readings . . . . .	.471

Breast cancer is a malignant proliferation of epithelial cells lining the ducts or lobules of the breast. In 2007, ~180,510 cases of invasive breast cancer and 40,910 deaths occurred in the United States. Epithelial malignancies of the breast are the most common cause of cancer in women (excluding skin cancer), accounting for about a third of all cancer in women. As a result of improved treatment and earlier detection, mortality from breast cancer has begun to decrease substantially in the United States. This chapter does not consider rare malignancies presenting in the breast, such as sarcomas and lymphomas, but focuses on the epithelial cancers. Human breast cancer is a clonal disease; a single transformed cell—the product of a series of somatic (acquired) or germline mutations—is eventually able to express full malignant potential. Thus breast cancer may exist for a long period as either a noninvasive disease or an invasive but nonmetastatic disease. These facts have significant clinical ramifications.

### GENETIC CONSIDERATIONS

 Not more than 10% of human breast cancers can be linked directly to germline mutations. Several genes have been implicated in familial cases. The Li-Fraumeni syndrome is characterized by inherited mutations in the p53 tumor-suppressor gene, which lead to

an increased incidence of breast cancer, osteogenic sarcomas, and other malignancies. Inherited mutations in *PTEN* have also been reported in breast cancer.

Another tumor-suppressor gene, *BRCA-1*, has been identified at the chromosomal locus 17q21; this gene encodes a zinc finger protein, and the product therefore may function as a transcription factor. The gene appears to be involved in gene repair. Women who inherit a mutated allele of this gene from either parent have at least a 60–80% lifetime chance of developing breast cancer and about a 33% chance of developing ovarian cancer. The risk is higher among women born after 1940, presumably due to promotional effects of hormonal factors. Men who carry a mutant allele of the gene have an increased incidence of prostate cancer and breast cancer. A fourth gene, termed *BRCA-2*, which has been localized to chromosome 13q12, is also associated with an increased incidence of breast cancer in men and women.

Germline mutations in *BRCA-1* and *BRCA-2* can be readily detected; patients with these mutations can be counseled appropriately. All women with strong family histories for breast cancer should be referred to genetic screening programs, particularly women of Ashkenazi Jewish descent who have a high likelihood of a specific *BRCA-1* mutation (deletion of adenine and guanine at position 185).

Even more important than the role these genes play in inherited forms of breast cancer may be their role in sporadic breast cancer. The p53 mutation is present in nearly 40% of human breast cancers as an acquired defect. Acquired mutations in *PTEN* occur in ~10% of the cases. *BRCA-1* mutation in sporadic primary breast cancer has not been reported. However, decreased expression of *BRCA-1* mRNA (possibly via gene methylation) and abnormal cellular location of the *BRCA-1* protein have been found in some breast cancers. Loss of heterozygosity of *BRCA-1* and *BRCA-2* suggests that tumor-suppressor activity may be inactivated in sporadic cases of human breast cancer. Finally, increased expression of a dominant oncogene plays a role in about a quarter of human breast cancer cases. The product of this gene, a member of the epidermal growth factor receptor superfamily, is called *erbB2* (HER-2, neu) and is overexpressed in these breast cancers due to gene amplification; this overexpression can contribute to transformation of human breast epithelium and is the target of effective systemic therapy in adjuvant and metastatic disease settings.

## EPIDEMIOLOGY

Breast cancer is a hormone-dependent disease. Women without functioning ovaries who never receive estrogen replacement therapy do not develop breast cancer. The female-to-male ratio is ~150:1. For most epithelial malignancies, a log-log plot of incidence versus age shows a single-component straight-line increase with every year of life. A similar plot for breast cancer shows two components: a straight-line increase with age but with a decrease in slope beginning at the age of menopause. The three dates in a woman's life that have a major impact on breast cancer incidence are age at menarche, age at first full-term pregnancy, and age at menopause. Women who experience menarche at age 16 have only 50–60% of the breast cancer risk of a woman having menarche at age 12; the lower risk persists throughout life. Similarly, menopause occurring 10 years before the median age of menopause (52 years), whether natural or surgically induced, reduces lifetime breast cancer risk by ~35%. Women who have a first full-term pregnancy by age 18 have a 30–40% lower risk of breast cancer compared with nulliparous women. Thus length of menstrual life—particularly the fraction occurring before first full-term pregnancy—is a substantial component of the total risk of breast cancer. These three factors (menarche, age of first full-term pregnancy, and menopause) can account for 70–80% of the variation in breast cancer frequency in different countries. A meta-analysis has shown that duration of maternal nursing correlates with substantial risk reduction independent of either parity or age at first full-term pregnancy.



International variation in incidence has provided some of the most important clues on hormonal carcinogenesis. A woman living to age 80 in North America has one chance in nine of developing invasive breast cancer. Asian women have a fifth to a tenth the risk of breast cancer of women in North America or Western Europe. Asian women have substantially lower concentrations of estrogens and progesterone. These differences cannot be explained on a genetic basis because Asian women living in a Western environment have sex steroid hormone concentrations and risks identical to those of their Western counterparts. These migrant women and more notably their daughters also differ markedly in height and weight from Asian women in Asia; height and weight are critical regulators of age of menarche and have substantial effects on plasma concentrations of estrogens.

The role of diet in breast cancer etiology is controversial. Although there are associative links between total caloric and fat intake and breast cancer risk, the exact role of fat in the diet is unproven. Increased caloric intake contributes to breast cancer risk in multiple ways: earlier menarche, later age at menopause, and increased postmenopausal estrogen concentrations reflecting enhanced aromatase activities in fatty tissues. Moderate alcohol intake also increases the risk by an unknown mechanism. Folic acid supplementation appears to modify risk in women who use alcohol but is not additionally protective in abstainers. Recommendations favoring abstinence from alcohol must be weighed against other social pressures and the possible cardioprotective effect of moderate alcohol intake.

Understanding the potential role of exogenous hormones in breast cancer is of extraordinary importance because millions of American women regularly use oral contraceptives and postmenopausal hormone replacement therapy (HRT). The most credible meta-analyses of oral contraceptive use suggest that these agents cause little if any increased risk of breast cancer. By contrast, oral contraceptives offer a substantial protective effect against ovarian epithelial tumors and endometrial cancers. Far more controversial are the data surrounding HRT in postmenopausal women. Data from the Women's Health Initiative (WHI) trial showed in a prospectively randomized design that conjugated equine estrogens plus progestins increased the risk of breast cancer and adverse cardiovascular events but with decreases in bone fractures and colorectal cancer. On balance there were more negative events with HRT. A parallel WHI trial with >12,000 women enrolled testing conjugated estrogens alone (in women who have had hysterectomies) showed no significant increase in breast cancer incidence. A meta-analysis of nonrandomized HRT studies suggests that most of the previously attributed benefit of HRT can be accounted for by higher socioeconomic status among users, which is presumably

associated with better access to health care and healthier behaviors. Certain potential benefits of HRT, such as a putative protective effect on cognition with age, were not assessed in WHI. HRT is an area of rapid reevaluation, but it would appear (at least from breast cancer and cardiovascular disease vantage points) that there are serious concerns about long-term HRT use. HRT in women previously diagnosed with breast cancer increases recurrence rates.

In addition to the other factors, radiation is a risk factor in younger women. Women who have been exposed before age 30 to radiation in the form of multiple fluoroscopies (200–300 cGy) or treatment for Hodgkin's disease (>3600 cGy) have a substantial increase in risk of breast cancer, whereas radiation exposure after age 30 appears to have a minimal carcinogenic effect on the breast.

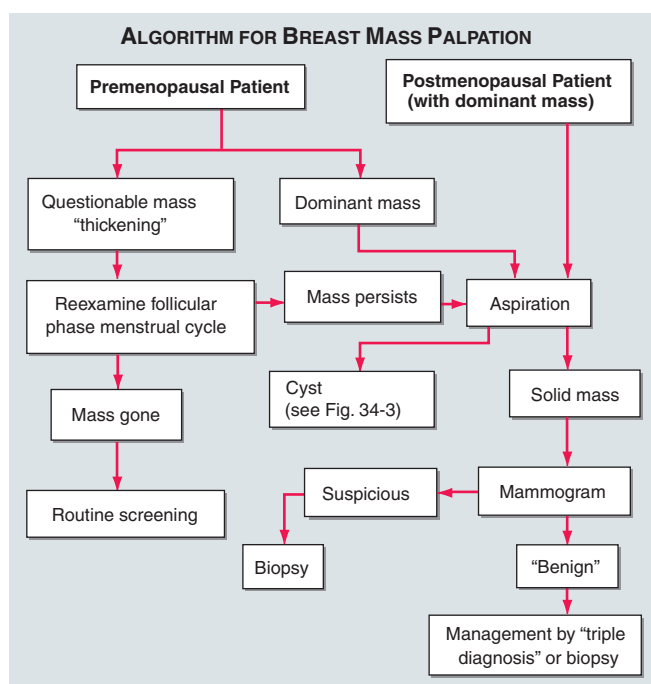
## EVALUATION OF BREAST MASSES IN MEN AND WOMEN

Because the breasts are a common site of potentially fatal malignancy in women and because they frequently provide clues to underlying systemic diseases in both men and women, examination of the breast is an essential part of the physical examination. Unfortunately, internists frequently do not examine breasts in men, and, in women, they are apt to defer this evaluation to gynecologists. Because of the plausible association between early detection and improved outcome, it is the duty of every physician to distinguish breast abnormalities at the earliest possible stage and to institute a diagnostic workup. Women should be trained in breast self-examination (BSE). Although breast cancer in men is unusual, unilateral lesions should be evaluated in the same manner as in women, with the recognition that gynecomastia in men can sometimes begin unilaterally and is often asymmetric.

Virtually all breast cancer is diagnosed by biopsy of a nodule detected either on a mammogram or by palpation. Algorithms have been developed to enhance the likelihood of diagnosing breast cancer and reduce the frequency of unnecessary biopsy (Fig. 34-1).

## THE PALPABLE BREAST MASS

Women should be strongly encouraged to examine their breasts monthly. A potentially flawed study from China has suggested that BSE does not alter survival, but given its safety, the procedure should still be encouraged. At worst, this practice increases the likelihood of detecting a mass at a smaller size when it can be treated with more limited surgery. Breast examination by the physician should be performed in good light so as to see retractions and other skin changes. The nipple and areolae

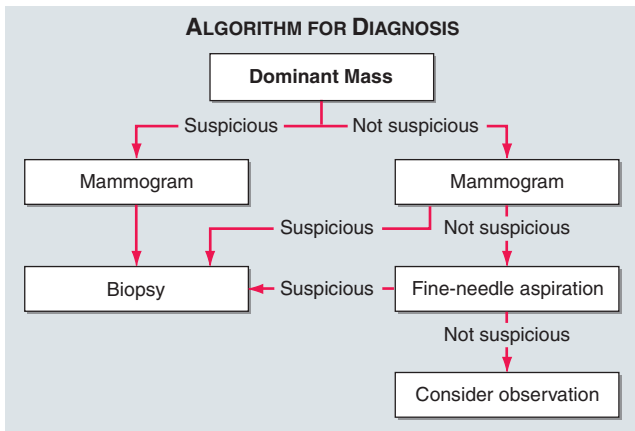


**FIGURE 34-1**  
Approach to a palpable breast mass.

should be inspected, and an attempt should be made to elicit nipple discharge. All regional lymph node groups should be examined, and any lesions should be measured. Physical examination alone cannot exclude malignancy. Lesions with certain features are more likely to be cancerous (hard, irregular, tethered or fixed, or painless lesions). A negative mammogram in the presence of a persistent lump in the breast does not exclude malignancy. Palpable lesions require additional diagnostic procedures including biopsy.

In premenopausal women, lesions that are either equivocal or nonsuspicious on physical examination should be reexamined in 2–4 weeks, during the follicular phase of the menstrual cycle. Days 5–7 of the cycle are the best time for breast examination. A dominant mass in a postmenopausal woman or a dominant mass that persists through a menstrual cycle in a premenopausal woman should be aspirated by fine-needle biopsy or referred to a surgeon. If nonbloody fluid is aspirated, the diagnosis (cyst) and therapy have been accomplished together. Solid lesions that are persistent, recurrent, complex, or bloody cysts require mammography and biopsy, although in selected patients the so-called triple diagnostic techniques (palpation, mammography, aspiration) can be used to avoid biopsy (Figs. 34-1, 34-2, and 34-3). Ultrasound can be used in place of fine-needle aspiration to distinguish cysts from solid lesions. Not all solid masses are detected by ultrasound; thus a palpable mass that is not visualized on ultrasound must be presumed to be solid.

Several points are essential in pursuing these management decision trees. First, risk-factor analysis is not part

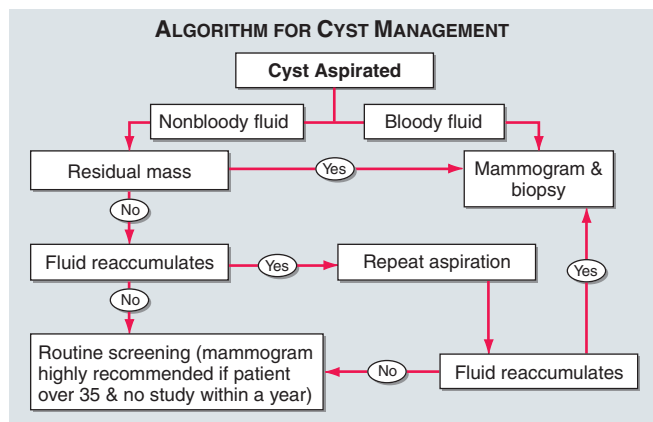


**FIGURE 34-2**  
The “triple diagnosis” technique.

of the decision structure. No constellation of risk factors, by their presence or absence, can be used to exclude biopsy. Second, fine-needle aspiration should be used only in centers that have proven skill in obtaining such specimens and analyzing them. The likelihood of cancer is low in the setting of a “triple negative” (benign-feeling lump, negative mammogram, and negative fine-needle aspiration), but it is not zero. The patient and physician must be aware of a 1% risk of false negatives. Third, additional technologies such as MRI, ultrasound, and sestamibi imaging cannot be used to exclude the need for biopsy, although in unusual circumstances they may provoke a biopsy.

## THE ABNORMAL MAMMOGRAM

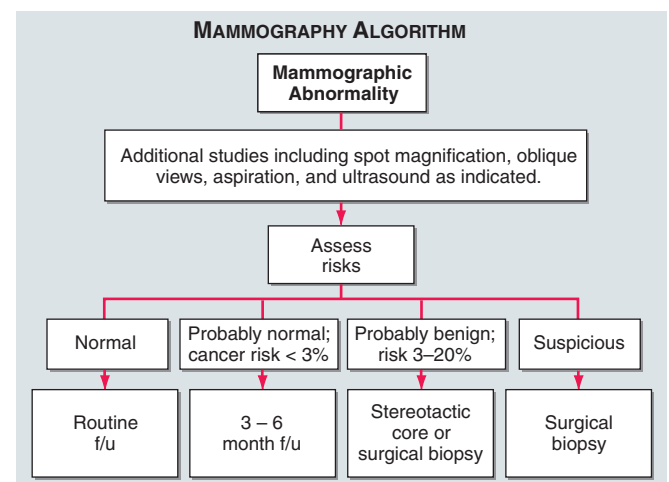
*Diagnostic mammography* should not be confused with *screening mammography*, which is performed after a palpable abnormality has been detected. Diagnostic mammography is aimed at evaluating the rest of the breast before biopsy is performed or occasionally is part of the triple-test strategy to exclude immediate biopsy.



**FIGURE 34-3**  
Management of a breast cyst.

Subtle abnormalities that are first detected by screening mammography should be evaluated carefully by compression or magnified views. These abnormalities include clustered microcalcifications, densities (especially if spiculated), and new or enlarging architectural distortion. For some nonpalpable lesions, ultrasound may be helpful either to identify cysts or to guide biopsy. If there is no palpable lesion and detailed mammographic studies are unequivocally benign, the patient should have routine follow-up appropriate to the patient’s age.

If a nonpalpable mammographic lesion has a low index of suspicion, mammographic follow-up in 3–6 months is reasonable. Workup of indeterminate and suspicious lesions has been rendered more complex by the advent of stereotactic biopsies. Morrow and colleagues have suggested that these procedures are indicated for lesions that require biopsy but are likely to be benign—that is, for cases in which the procedure probably will eliminate additional surgery. When a lesion is more probably malignant, open biopsy should be performed with a needle localization technique. Others have proposed more widespread use of stereotactic core biopsies for nonpalpable lesions on economic grounds and because diagnosis leads to earlier treatment planning. However, stereotactic diagnosis of a malignant lesion does not eliminate the need for definitive surgical procedures, particularly if breast conservation is attempted. For example, after a breast biopsy with needle localization (i.e., local excision) of a stereotactically diagnosed malignancy, reexcision may still be necessary to achieve negative margins. To some extent, these issues are decided on the basis of referral pattern and the availability of the resources for stereotactic core biopsies. A reasonable approach is shown in Fig. 34-4.



**FIGURE 34-4**  
Approaches to abnormalities detected by mammogram.

## BREAST MASSES IN THE PREGNANT OR LACTATING WOMAN

During pregnancy, the breast grows under the influence of estrogen, progesterone, prolactin, and human placental lactogen. Lactation is suppressed by progesterone, which blocks the effects of prolactin. After delivery, lactation is promoted by the fall in progesterone levels, which leaves the effects of prolactin unopposed. The development of a dominant mass during pregnancy or lactation should never be attributed to hormonal changes. A dominant mass must be treated with the same concern in a pregnant woman as any other. Breast cancer develops in 1 in every 3000–4000 pregnancies. Stage for stage, breast cancer in pregnant patients is no different from premenopausal breast cancer in nonpregnant patients. However, pregnant women often have more advanced disease because the significance of a breast mass was not fully considered and/or because of endogenous hormone stimulation. Persistent lumps in the breast of pregnant or lactating women *cannot* be attributed to benign changes based on physical findings; such patients should be promptly referred for diagnostic evaluation.

## BENIGN BREAST MASSES

Only ~1 in every 5–10 breast biopsies leads to a diagnosis of cancer, although the rate of positive biopsies varies in different countries and clinical settings. (These differences may be related to interpretation, medicolegal considerations, and availability of mammograms.) The vast majority of benign breast masses are due to “fibrocystic” disease, a descriptive term for small fluid-filled cysts and modest epithelial cell and fibrous tissue hyperplasia. However, fibrocystic disease is a histologic, not a clinical, diagnosis, and women who have had a biopsy with benign findings are at greater risk of developing breast cancer than those who have not had a biopsy. The subset of women with ductal or lobular cell proliferation (~30% of patients), particularly the small fraction (3%) with atypical hyperplasia, have a fourfold greater risk of developing breast cancer than unbiopsied women, and the increase in the risk is about ninefold for women in this category who also have an affected first-degree relative. Thus careful follow-up of these patients is required. By contrast, patients with a benign biopsy without atypical hyperplasia are at little risk and may be followed routinely.

## SCREENING

Breast cancer is virtually unique among the epithelial tumors in adults in that screening (in the form of annual mammography) improves survival. Meta-analysis examining outcomes from every randomized trial of mammography conclusively shows a 25–30% reduction in the

chance of dying from breast cancer with annual screening after age 50; the data for women between ages 40 and 50 are almost as positive. Although controversy continues to surround the assessment of screening mammography, the preponderance of data strongly supports the benefits of screening mammography. New analyses of older randomized studies have suggested that screening may not work. Although the design defects in some older studies cannot be retrospectively corrected, most experts, including panels of the American Society of Clinical Oncology and the American Cancer Society, continue to believe that screening conveys substantial benefit. Furthermore, the profound drop in breast cancer mortality seen over the past decade is unlikely to be solely attributable to improvements in therapy. It seems prudent to recommend annual mammography for women past the age of 40. Although no randomized study of BSE has ever shown any improvement in survival, its major benefit is identification of tumors appropriate for conservative local therapy. Better mammographic technology, including digitized mammography, routine use of magnified views, and greater skill in mammographic interpretation, combined with newer diagnostic techniques (MRI, magnetic resonance spectroscopy, positron emission tomography, etc.), may make it possible to identify breast cancers even more reliably and earlier. Screening by any technique other than mammography is not indicated; however, younger women who are *BRCA-1* or *BRCA-2* carriers may benefit from MRI screening where the higher sensitivity may outweigh the loss of specificity.

## STAGING

Correct staging of breast cancer patients is of extraordinary importance. Not only does it permit an accurate prognosis, but in many cases therapeutic decision making is based largely on the TNM (primary tumor, regional nodes, metastasis) classification ([Table 34-1](#)). Comparison with historic series should be undertaken with caution because the staging has changed several times in the past 20 years. The current staging is complex and results in significant changes in outcome by stage as compared with prior staging systems.

### **Rx** Treatment: BREAST CANCER

**PRIMARY BREAST CANCER** Breast-conserving treatments, consisting of the removal of the primary tumor by some form of lumpectomy with or without irradiating the breast, result in a survival that is as good as (or slightly superior to) that after extensive surgical procedures, such as mastectomy or modified radical mastectomy, with or without further irradiation. Postlumpectomy



## STAGING OF BREAST CANCER

## Primary Tumor (T)

T0	No evidence of primary tumor
TIS	Carcinoma in situ
T1	Tumor $\leq 2$ cm
T1a	Tumor $>0.1$ cm but $\leq 0.5$ cm
T1b	Tumor $>0.5$ cm but $\leq 1$ cm
T1c	Tumor $>1$ cm but $\leq 2$ cm
T2	Tumor $>2$ cm but $\leq 5$ cm
T3	Tumor $>5$ cm
T4	Extension to chest wall, inflammation, satellite lesions, ulcerations

## Regional Lymph Nodes (N)

PN0(i-)	No regional lymph node metastasis histologically, negative IHC
PN0(i+)	No regional lymph node metastasis histologically, positive IHC, no IHC cluster $>0.2$ mm
PN0(mol-)	No regional lymph node metastasis histologically, negative molecular findings (RT-PCR) <sup>a</sup>
PN0(mol+)	No regional lymph node metastasis histologically, positive molecular findings (RT-PCR) <sup>a</sup>
PN1	Metastasis in 1–3 axillary lymph nodes, or in internal mammary nodes with microscopic disease detected by sentinel lymph node dissection but not clinically apparent
PN1mi	Micrometastasis ( $>0.2$ mm, none $>2.0$ mm)
PN1a	Metastasis in 1–3 axillary lymph nodes
PN1b	Metastasis in internal mammary nodes with microscopic disease detected by sentinel lymph node dissection but not <i>clinically apparent</i> <sup>b</sup>
PN1c	Metastasis in 1–3 axillary lymph nodes and in internal mammary lymph nodes with microscopic disease detected by sentinel lymph node dissection but not clinically apparent. <sup>b</sup> (If associated with $>3$ positive axillary lymph nodes, the internal mammary nodes are classified as pN3b to reflect increased tumor burden.)
pN2	Metastasis in 4–9 axillary lymph nodes, or in clinically apparent internal mammary lymph nodes in the <i>absence</i> of axillary lymph node metastasis
pN3	Metastasis in $\geq 10$ axillary lymph nodes, or in infraclavicular lymph nodes, or in clinically apparent <sup>c</sup> ipsilateral internal mammary lymph nodes in the <i>presence</i> of $\geq 1$ positive axillary lymph nodes; or in $>3$ axillary lymph nodes with clinically negative microscopic metastasis in internal mammary lymph nodes; or in ipsilateral SCLNs

## Distant Metastasis (M)

M0	No distant metastasis
M1	Distant metastasis (includes spread to ipsilateral supraclavicular nodes)

## Stage Grouping

Stage 0	TIS	N0	M0
Stage I	T1	N0	M0
Stage IIA	T0	N1	M0
	T1	N1	M0
	T2	N0	M0
Stage IIB	T2	N1	M0
	T3	N0	M0
Stage IIIA	T0	N2	M0
	T1	N2	M0
	T2	N2	M0
	T3	N1, N2	M0
Stage IIIB	T4	Any N	M0
	Any T	N3	M0
Stage IIIC	Any T	N3	M0
Stage IV	Any T	Any N	M1

<sup>a</sup>RT-PCR, reverse transcriptase/polymerase chain reaction.<sup>b</sup>Clinically apparent is defined as detected by imaging studies (excluding lymphoscintigraphy) or by clinical examination.<sup>c</sup>T1 includes T1mic.**Source:** Used with permission of the American Joint Committee on Cancer (AJCC), Chicago, Illinois. The original source for this material is the AJCC Cancer Staging Manual, Sixth Edition (2002) published by Springer-New York, [www.springeronline.com](http://www.springeronline.com).

breast irradiation greatly reduces the risk of recurrence in the breast. Although breast conservation is associated with a possibility of recurrence in the breast, 10-year survival is at least as good as that after more radical surgery. Postoperative radiation to regional nodes following mastectomy is also associated with an improvement in survival. Because radiation therapy can also reduce the rate of local or regional recurrence, it should be strongly considered following mastectomy for women with high-risk primary tumors (i.e., T2 in size, positive margins, positive nodes). At present, nearly a third of women in the United States are managed by lumpectomy. Breast-conserving surgery is not suitable for all patients: it is not generally suitable for tumors >5 cm (or for smaller tumors if the breast is small), for tumors involving the nipple areola complex, for tumors with extensive intraductal disease involving multiple quadrants of the breast, for women with a history of collagen-vascular disease, and for women who either do not have the motivation for breast conservation or do not have convenient access to radiation therapy. However, these groups probably do not account for more than a third of patients who are treated with mastectomy. Thus a great many women still undergo mastectomy who could safely avoid this procedure and probably would if appropriately counseled.

An extensive intraductal component is a predictor of recurrence in the breast, and so are several clinical variables. Both axillary lymph node involvement and involvement of vascular or lymphatic channels by metastatic tumor in the breast are associated with a higher risk of relapse in the breast but are not contraindications to breast-conserving treatment. When these patients are excluded, and when lumpectomy with negative tumor margins is achieved, breast conservation is associated with a recurrence rate in the breast of substantially <10%. The survival of patients who have recurrence in the breast is somewhat worse than that of women who do not. Thus recurrence in the breast is a negative prognostic variable for long-term survival. However, recurrence in the breast is not the *cause* of distant metastasis. If recurrence in the breast caused metastatic disease, then women treated with lumpectomy, who have a higher rate of recurrence in the breast, should have poorer survival than women treated with mastectomy, and they do not. Most patients should consult with a radiation oncologist before making a final decision concerning local therapy. However, a multimodality clinic in which the surgeon, radiation oncologist, medical oncologist, and other caregivers cooperate to evaluate the patient and develop a treatment is usually considered a major advantage by patients.

**Adjuvant Therapy** The use of systemic therapy after local management of breast cancer substantially improves

**TABLE 34-2****5-YEAR SURVIVAL RATE FOR BREAST CANCER BY STAGE**

STAGE	5-YEAR SURVIVAL, %
0	99
I	92
IIA	82
IIB	65
IIIA	47
IIIB	44
IV	14

**Source:** Modified from data of the National Cancer Institute—Surveillance, Epidemiology, and End Results (SEER).

survival. More than a third of the women who would otherwise die of metastatic breast cancer remain disease-free when treated with the appropriate systemic regimen.

**Prognostic Variables** The most important prognostic variables are provided by *tumor staging*. The size of the tumor and the status of the axillary lymph nodes provide reasonably accurate information on the likelihood of tumor relapse. The relation of pathologic stage to 5-year survival is shown in [Table 34-2](#). For most women, the need for adjuvant therapy can be readily defined on this basis alone. In the absence of lymph node involvement, involvement of microvessels (either capillaries or lymphatic channels) in tumors is nearly equivalent to lymph node involvement. The greatest controversy concerns women with intermediate prognoses. *There is rarely justification for adjuvant chemotherapy in most women with tumors <1 cm in size whose axillary lymph nodes are negative.* Detection of breast cancer cells either in the circulation or bone marrow is associated with an increased relapse rate. The most exciting development in this area is the use of gene expression arrays to analyze patterns of tumor gene expression. Several groups have independently defined gene sets that reliably predict disease-free and overall survival far more accurately than any single prognostic variable. Their value is now being assessed in prospective randomized trials. In addition, gene sets capable of predicting responses to endocrine therapy and specific chemotherapeutic drugs have also been described.

*Estrogen and progesterone receptor status* are of prognostic significance. Tumors that lack either or both of these receptors are more likely to recur than tumors that have them.

Several *measures of tumor growth rate* correlate with early relapse. S-phase analysis using flow cytometry is the most accurate measure. Indirect S-phase assessments using antigens associated with the cell cycle, such as PCNA (Ki67), are also valuable. Tumors with a

high proportion (more than the median) of cells in S-phase pose a greater risk of relapse; chemotherapy offers the greatest survival benefit for these tumors. Assessment of DNA content in the form of ploidy is of modest value, with nondiploid tumors having a somewhat worse prognosis.

*Histologic classification* of the tumor has also been used as a prognostic factor. Tumors with a poor nuclear grade have a higher risk of recurrence than tumors with a good nuclear grade. Semiquantitative measures such as the Elston score improve the reproducibility of this measurement.

*Molecular changes in the tumor* are also useful. Tumors that overexpress *erbB2* (HER-2/neu) or have a mutated p53 gene have a worse prognosis. Particular interest has centered on *erbB2* overexpression as measured by histochemistry or by fluorescence in situ hybridization. Tumors that overexpress *erbB2* are more likely to respond to higher doses of doxorubicin-containing regimens and predict those tumors that will respond to HER-2/neu antibodies (trastuzumab) (Herceptin) and a Her-2/neu kinase inhibitor.

To grow, tumors must generate a neovasculature (Chap. 24). The presence of more microvessels in a tumor, particularly when localized in so-called hot spots, is associated with a worse prognosis. This may assume even greater significance in light of blood vessel–targeting therapies such as bevacizumab (Avastin).

Other variables that have also been used to evaluate prognosis include proteins associated with invasiveness, such as type IV collagenase, cathepsin D, plasminogen activator, plasminogen activator receptor, and the metastasis-suppressor gene *nm23*. None of these has been widely accepted as a prognostic variable for therapeutic decision making. One problem in interpreting these prognostic variables is that most of them have not been examined in a study using a large cohort of patients.

**Adjuvant Regimens** Adjuvant therapy is the use of systemic therapies in patients whose known disease has received local therapy but who are at risk of relapse. Selection of appropriate adjuvant chemotherapy or hormone therapy is highly controversial in some situations. Meta-analyses have helped to define broad limits for therapy but do not help in choosing optimal regimens or in choosing a regimen for certain subgroups of patients. A summary of recommendations is shown in [Table 34-3](#). In general, premenopausal women for whom any form of adjuvant systemic therapy is indicated should receive multidrug chemotherapy. The antiestrogen tamoxifen improves survival in premenopausal patients with positive estrogen receptors and should be added following completion of chemotherapy. Prophylactic castration may also be associated with a substantial survival benefit (primarily in estrogen receptor–positive patients) but is not widely used in the United States.

TABLE 34-3

## SUGGESTED APPROACHES TO ADJUVANT THERAPY

AGE GROUP	LYMPH NODE STATUS <sup>a</sup>	ENDOCRINE RECEPTOR (ER) STATUS	TUMOR	RECOMMENDATION
Premenopausal	Positive	Any	Any	Multidrug chemotherapy + tamoxifen if ER-positive + trastuzumab in HER-2/neu positive tumors
Premenopausal	Negative	Any	>2 cm, or 1–2 cm with other poor prognostic variables	Multidrug chemotherapy + tamoxifen if ER-positive + trastuzumab in HER-2/neu positive tumors
Postmenopausal	Positive	Negative	Any	Multidrug chemotherapy + trastuzumab in HER-2/neu positive tumors
Postmenopausal	Positive	Positive	Any	Aromatase inhibitors and tamoxifen with or without chemotherapy + trastuzumab in HER-2/neu positive tumors
Postmenopausal	Negative	Positive	>2 cm, or 1–2 cm with other poor prognostic variables	Aromatase inhibitors and tamoxifen + trastuzumab in HER-2/neu positive tumors
Postmenopausal	Negative	Negative	>2 cm, or 1–2 cm with other poor prognostic variables	Consider multidrug chemotherapy + trastuzumab in HER-2/neu positive tumors

<sup>a</sup>As determined by pathologic examination.

Data on postmenopausal women are also controversial. The impact of adjuvant chemotherapy is quantitatively less clear-cut than in premenopausal patients, although survival advantages have been shown. The first decision is whether chemotherapy or endocrine therapy should be used. Although adjuvant tamoxifen improves survival regardless of axillary lymph node status, the improvement in survival is modest for patients in whom multiple lymph nodes are involved. For this reason, it has been usual to give chemotherapy to postmenopausal patients who have no medical contraindications and who have more than one positive lymph node; tamoxifen is commonly given simultaneously or subsequently. For postmenopausal women for whom systemic therapy is warranted but who have a more favorable prognosis, tamoxifen may be used as a single agent. Large clinical trials have shown superiority for aromatase inhibitors over tamoxifen alone in the adjuvant setting. Unfortunately, the optimal plan is unclear. Tamoxifen for 5 years followed by an aromatase inhibitor, the reverse strategy, or even switching to an aromatase inhibitor after 2–3 years of tamoxifen has been shown to be better than tamoxifen alone. No valid information currently permits selection among the three clinically approved aromatase inhibitors. Large clinical trials currently underway will help address these questions.

Most comparisons of adjuvant chemotherapy regimens show little difference among them, although small advantages for doxorubicin-containing regimens are usually seen.

One approach—so-called neoadjuvant chemotherapy—involves the administration of adjuvant therapy before definitive surgery and radiation therapy. Because the objective response rates of patients with breast cancer to systemic therapy in this setting exceed 75%, many patients will be “downstaged” and may become candidates for breast-conserving therapy. However, overall survival has not been improved using this approach.

Other adjuvant treatments under investigation include the use of taxanes, such as paclitaxel and docetaxel, and therapy based on alternative kinetic and biologic models. In such approaches, high doses of single agents are used separately in relatively dose-intensive cycling regimens. Node-positive patients treated with doxorubicin-cyclophosphamide for four cycles followed by four cycles of a taxane have a substantial improvement in survival as compared with women receiving doxorubicin-cyclophosphamide alone, particularly in women with estrogen receptor–negative tumors. In addition, administration of the same drug combinations at the same dose but at more frequent intervals (every 2 weeks with cytokine support as compared with the standard every 3 weeks) is even more effective. Among the 25% of women whose tumors overexpress HER-2/neu, addition of trastuzumab given concurrently with a taxane

and then for a year after chemotherapy produces significant improvement in survival. Although longer follow-up will be important, this is now the standard care for most women with HER-2/neu positive breast cancers. Cardiotoxicity, immediate and long-term, remains a concern, and further efforts to exploit nonanthracycline-containing regimens are being pursued. Very-high-dose therapy with stem cell transplantation in the adjuvant setting has not proved superior to standard dose therapy and should not be routinely used.

### SYSTEMIC THERAPY OF METASTATIC DISEASE

Nearly half of patients treated for apparently localized breast cancer develop metastatic disease. Although a small number of these patients enjoy long remissions when treated with combinations of systemic and local therapy, most eventually succumb to metastatic disease. Soft tissue, bony, and visceral (lung and liver) metastases each account for approximately a third of sites of initial relapses. However, by the time of death, most patients will have bony involvement. Recurrences can appear at any time after primary therapy. Half of all initial cancer recurrences occur >5 years after initial therapy.

Because the diagnosis of metastatic disease alters the outlook for the patient so drastically, it should rarely be made without biopsy. Every oncologist has seen patients with tuberculosis, gallstones, sarcoidosis, or other nonmalignant diseases misdiagnosed and treated as though they had metastatic breast cancer or even second malignancies such as multiple myeloma thought to be recurrent breast cancer. This is a catastrophic mistake and justifies biopsy for virtually every patient at the time of initial suspicion of metastatic disease.

The choice of therapy requires consideration of local therapy needs, the overall medical condition of the patient, and the hormone receptor status of the tumor, as well as clinical judgment. Because therapy of systemic disease is palliative, the potential toxicities of therapies should be balanced against the response rates. Several variables influence the response to systemic therapy. For example, the presence of estrogen and progesterone receptors is a strong indication for endocrine therapy. However, patients with short disease-free intervals, rapidly progressive visceral disease, lymphangitic pulmonary disease, or intracranial disease are unlikely to respond to endocrine therapy.

In many cases, systemic therapy can be withheld while the patient is managed with appropriate local therapy. Radiation therapy and occasionally surgery are effective at relieving the symptoms of metastatic disease, particularly when bony sites are involved. Many patients with bone-only or bone-dominant disease have a relatively indolent course. Under such circumstances, systemic chemotherapy has a modest effect, whereas radiation therapy may be effective for long periods.

Other systemic treatments, such as strontium 89 and/or bisphosphonates, may provide a palliative benefit without inducing objective responses. Most patients with metastatic disease and certainly all who have bone involvement should receive concurrent bisphosphonates. Because the goal of therapy is to maintain well-being for as long as possible, emphasis should be placed on avoiding the most hazardous complications of metastatic disease, including pathologic fracture of the axial skeleton and spinal cord compression. New back pain in patients with cancer should be explored aggressively on an emergent basis; to wait for neurologic symptoms is a potentially catastrophic error. Metastatic involvement of endocrine organs can cause profound dysfunction, including adrenal insufficiency and hypopituitarism. Similarly, obstruction of the biliary tree or other impaired organ function may be better managed with a local therapy than with a systemic approach.

**Endocrine Therapy** Normal breast tissue is estrogen-dependent. Both primary and metastatic breast cancer may retain this phenotype. The best means of ascertaining whether a breast cancer is hormone-dependent is through analysis of estrogen and progesterone receptor levels on the tumor. Tumors that are positive for the estrogen receptor and negative for the progesterone receptor have a response rate of ~30%. Tumors that have both receptors have a response rate approaching 70%. If neither receptor is present, the objective response rates are <10%. Receptor analyses provide information as to the correct ordering of endocrine therapies as opposed to chemotherapy. Because of their lack of toxicity and because some patients whose receptor analyses are reported as negative respond to endocrine therapy, an endocrine treatment should be attempted in virtually every patient with metastatic breast cancer. Potential endocrine therapies are summarized in [Table 34-4](#). The choice of endocrine therapy is usually determined by toxicity profile and availability. In most patients, the initial endocrine therapy should be an aromatase inhibitor rather than tamoxifen. For the subset of women who are ER positive but also HER-2/neu positive, response rates to aromatase inhibitors are very substantially higher than to tamoxifen. Newer “pure” antiestrogens that are free of agonistic effects are also in clinical trial. Cases in which tumors shrink in response to tamoxifen withdrawal (as well as withdrawal of pharmacologic doses of estrogens) have been reported. Endogenous estrogen formation may be blocked by analogues of luteinizing hormone–releasing hormone in premenopausal women. Additive endocrine therapies, including treatment with progestogens, estrogens, and androgens, may also be tried in patients who respond to initial endocrine therapy; the mechanism of action of these latter therapies is unknown. Patients who respond

**TABLE 34-4****ENDOCRINE THERAPIES FOR BREAST CANCER**

THERAPY	COMMENTS
Castration Surgical LHRH agonists	For premenopausal women
Antiestrogens Tamoxifen “Pure” antiestrogens	Useful in pre- and postmenopausal women Responses in tamoxifen-resistant and aromatase inhibitor resistant patients
Surgical adrenalectomy	Rarely employed second-line choice
Aromatase inhibitors	Low toxicity; now first choice for metastatic disease
High-dose progestogens	Common fourth-line choice after AIs, tamoxifen, and fulvestrant
Hypophysectomy	Rarely used
Additive androgens or estrogens	Plausible fourth-line therapies; potentially toxic

**Note:** LHRH, luteinizing hormone–releasing hormone.

to one endocrine therapy have at least a 50% chance of responding to a second endocrine therapy. It is not uncommon for patients to respond to two or three sequential endocrine therapies; however, combination endocrine therapies do not appear to be superior to individual agents, and combinations of chemotherapy with endocrine therapy are not useful. The median survival of patients with metastatic disease is approximately 2 years, and many patients, particularly older persons and those with hormone-dependent disease, may respond to endocrine therapy for 3–5 years or longer.

**Chemotherapy** Unlike many other epithelial malignancies, breast cancer responds to multiple chemotherapeutic agents, including anthracyclines, alkylating agents, taxanes, and antimetabolites. Multiple combinations of these agents have been found to improve response rates somewhat, but they have had little effect on duration of response or survival. The choice among multidrug combinations frequently depends on whether adjuvant chemotherapy was administered and, if so, what type. Although patients treated with adjuvant regimens such as cyclophosphamide, methotrexate, and fluorouracil (CMF regimens) may subsequently respond to the same combination in the metastatic disease setting, most oncologists use drugs to which the patients have not been previously exposed. Once patients have progressed after combination drug therapy, it is most common to treat them with single agents. Given the significant toxicity of most drugs, the use of a single effective agent minimizes toxicity by sparing the patient exposure to drugs that would be of little value. No

method to select the drugs most efficacious for a given patient has been demonstrated to be useful.

Most oncologists use either an anthracycline or paclitaxel following failure with the initial regimen. However, the choice has to be balanced with individual needs. One randomized study has suggested docetaxel may be superior to paclitaxel. A nanoparticle formulation of paclitaxel (Abraxane) has also shown promise.

The use of a humanized antibody to *erbB2* [trastuzumab (Herceptin)] combined with paclitaxel can improve response rate and survival for women whose metastatic tumors overexpress *erbB2*. The magnitude of the survival extension is modest in patients with metastatic disease. Similarly, the use of bevacizumab (Avastin) has improved the response rate and response duration to paclitaxel. Objective responses in previously treated patients may also be seen with gemcitabine, capecitabine, Navelbine, and oral etoposide.

**High-Dose Chemotherapy Including Autologous Bone Marrow Transplantation**

Autologous bone marrow transplantation combined with high doses of single agents can produce objective responses even in heavily pretreated patients. However, such responses are rarely durable and do not alter the clinical course for most patients with advanced metastatic disease.

**STAGE III BREAST CANCER** Between 10 and 25% of patients present with so-called locally advanced, or stage III, breast cancer at diagnosis. Many of these cancers are technically operable, whereas others, particularly cancers with chest wall involvement, inflammatory breast cancers, or cancers with large matted axillary lymph nodes, cannot be managed with surgery initially. Although no randomized trials have proved the efficacy of neoadjuvant chemotherapy, this approach has gained widespread use. More than 90% of patients with locally advanced breast cancer show a partial or better response to multidrug chemotherapy regimens that include an anthracycline. Early administration of this treatment reduces the bulk of the disease and frequently makes the patient a suitable candidate for salvage surgery and/or radiation therapy. These patients should be managed in multimodality clinics to coordinate surgery, radiation therapy, and systemic chemotherapy. Such approaches produce long-term disease-free survival in ~30–50% of patients.

**BREAST CANCER PREVENTION** Women who have one breast cancer are at risk of developing a contralateral breast cancer at a rate of ~0.5% per year. When adjuvant tamoxifen is administered to these patients, the rate of development of contralateral breast cancers is reduced. In other tissues of the body, tamoxifen has estrogen-like effects that are beneficial: preservation of bone mineral density and long-term lowering

of cholesterol. However, tamoxifen has estrogen-like effects on the uterus, leading to an increased risk of uterine cancer (0.75% incidence after 5 years on tamoxifen). Tamoxifen also increases the risk of cataract formation. The Breast Cancer Prevention Trial (BCPT) revealed a >49% reduction in breast cancer among women with a risk of at least 1.66% taking the drug for 5 years. Raloxifene has shown similar breast cancer prevention potency but may have different effects on bone and heart. The two agents have been compared in a prospective randomized prevention trial (the STAR trial). The agents are approximately equivalent in preventing breast cancer with fewer thromboembolic events and endometrial cancers with raloxifene; however, raloxifene did not reduce noninvasive cancers as effectively as tamoxifen, so no clear winner has emerged.

**NONINVASIVE BREAST CANCER** Breast cancer develops as a series of molecular changes in the epithelial cells that lead to ever more malignant behavior. Increased use of mammography has led to more frequent diagnosis of noninvasive breast cancer. These lesions fall into two groups: ductal carcinoma in situ (DCIS) and lobular carcinoma in situ (lobular neoplasia). The management of both entities is controversial.

**Ductal Carcinoma in Situ (DCIS)** Proliferation of cytologically malignant breast epithelial cells within the ducts is termed *DCIS*. Atypical hyperplasia may be difficult to differentiate from DCIS. At least a third of patients with untreated DCIS develop invasive breast cancer within 5 years. For many years, the standard treatment for this disease was mastectomy. However, treatment of this condition by lumpectomy and radiation therapy gives survival that is as good as the survival for invasive breast cancer treated by mastectomy. In one randomized trial, the combination of wide excision plus irradiation for DCIS caused a substantial reduction in the local recurrence rate as compared with wide excision alone with negative margins, although survival was identical in the two arms. No studies have compared either of these regimens to mastectomy. Addition of tamoxifen to any DCIS surgical/radiation therapy regimen further improves local control. Data for aromatase inhibitors in this setting are not available.

Several prognostic features may help to identify patients at high risk for local recurrence after either lumpectomy alone or lumpectomy with radiation therapy. These include extensive disease; age <40; and cytologic features such as necrosis, poor nuclear grade, and comedo subtype with overexpression of *erbB2*. Some data suggest that adequate excision with careful determination of pathologically clear margins is associated with a low recurrence rate. When surgery is combined with radiation therapy, recurrence (which is usually

in the same quadrant) occurs with a frequency of  $\leq 10\%$ . Given the fact that half of these recurrences will be invasive,  $\sim 5\%$  of the initial cohort will eventually develop invasive breast cancer. A reasonable expectation of mortality for these patients is  $\sim 1\%$ , a figure that approximates the mortality rate for DCIS managed by mastectomy. Although this train of reasoning has not formally been proved valid, it is reasonable to recommend that patients who desire breast preservation, and in whom DCIS appears to be reasonably localized, be managed by adequate surgery with meticulous pathologic evaluation, followed by breast irradiation and tamoxifen. For patients with localized DCIS, axillary lymph node dissection is unnecessary. More controversial is the question of what management is optimal when there is any degree of invasion. Because of a significant likelihood (10–15%) of axillary lymph node involvement even when the primary lesion shows only microscopic invasion, it is prudent to do at least a level 1 and 2 axillary lymph node dissection for all patients with any degree of invasion; sentinel node biopsy may be substituted. Further management is dictated by the presence of nodal spread.

**Lobular Neoplasia** Proliferation of cytologically malignant cells within the lobules is termed *lobular neoplasia*. Nearly 30% of patients who have had adequate local excision of the lesion develop breast cancer (usually infiltrating ductal carcinoma) over the next 15–20 years. Ipsilateral and contralateral cancers are equally common. Therefore, lobular neoplasia may be a premalignant lesion that suggests an elevated risk of subsequent breast cancer, rather than a form of malignancy itself, and aggressive local management seems unreasonable. Most patients should be treated with tamoxifen for 5 years and followed with careful annual mammography and semiannual physical examinations. Additional molecular analysis of these lesions may make it possible to discriminate between patients who are at risk of further progression and require additional therapy and those in whom simple follow-up is adequate.

**MALE BREAST CANCER** Breast cancer is  $\sim 1/150$ th as frequent in men as in women; 1720 men developed breast cancer in 2006. It usually presents as a unilateral lump in the breast and is frequently not diagnosed promptly. Given the small amount of soft tissue and the unexpected nature of the problem, locally advanced presentations are somewhat more common. When male breast cancer is matched to female breast cancer by age and stage, its overall prognosis is identical. Although gynecomastia may initially be unilateral or asymmetric, any unilateral mass in a man  $>40$  years of age should receive a careful workup including biopsy. However, bilateral symmetric breast development rarely represents breast cancer and is almost invariably due to

endocrine disease or a drug effect. It should be kept in mind, nevertheless, that the risk of cancer is much greater in men with gynecomastia; in such men, gross asymmetry of the breasts should arouse suspicion of cancer. Male breast cancer is best managed by mastectomy and axillary lymph node dissection (modified radical mastectomy). Patients with locally advanced disease or positive nodes should also be treated with irradiation. Approximately 90% of male breast cancers contain estrogen receptors, and approximately 60% of cases with metastatic disease respond to endocrine therapy. No randomized studies have evaluated adjuvant therapy for male breast cancer. Two historic experiences suggest that the disease responds well to adjuvant systemic therapy, and, if not medically contraindicated, the same criteria for the use of adjuvant therapy in women should be applied to men.

The sites of relapse and spectrum of response to chemotherapeutic drugs are virtually identical for breast cancers in either sex.

## FOLLOW-UP OF BREAST CANCER PATIENTS

Despite the availability of sophisticated and expensive imaging techniques and a wide range of serum tumor marker tests, survival is not influenced by early diagnosis of relapse. Surveillance guidelines are given in [Table 34-5](#).

**TABLE 34-5**

### BREAST CANCER SURVEILLANCE GUIDELINES

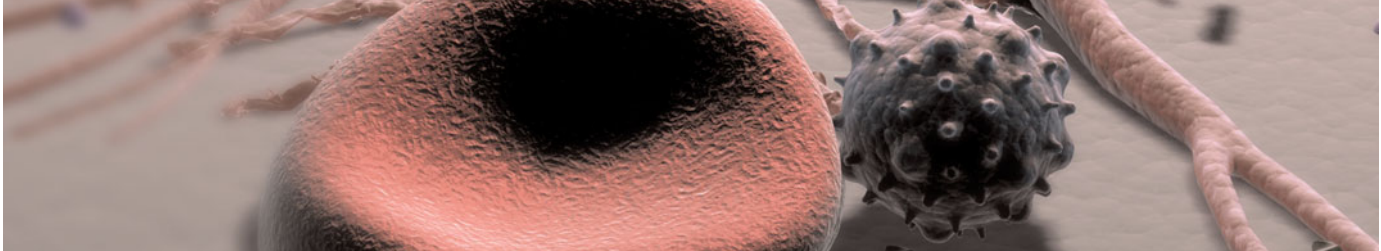
TEST	FREQUENCY
<b>Recommended</b>	
History; eliciting symptoms; physical examination	q3–6 months $\times$ 3 years; q6–12 months $\times$ 2 years; then annually
Breast self-examination	Monthly
Mammography	Annually
Pelvic examination	Annually
Patient education about symptoms of recurrence	Ongoing
Coordination of care	Ongoing
<b>Not Recommended</b>	
Complete blood count	
Serum chemistry studies	
Chest radiographs	
Bone scans	
Ultrasound examination of the liver	
Computed tomography of chest, abdomen, or pelvis	
Tumor marker CA 15-3, CA 27-29	
Tumor marker CEA	

**Source:** *Recommended Breast Cancer Surveillance Guidelines*, ASCO Education Book, Fall 1997.

## FURTHER READINGS

- BREAST INTERNATIONAL GROUP (BIG) 1–98 COLLABORATIVE GROUP: A comparison of letrozole and tamoxifen in postmenopausal women with early breast cancer. *N Engl J Med* 353:2747, 2005
- CITRON ML et al: Randomized trial of dose-dense versus conventionally scheduled and sequential versus concurrent combination chemotherapy as postoperative adjuvant treatment of node-positive primary breast cancer: First report of intergroup trial C9741/cancer and leukemia group B trial 9741. *J Clin Oncol* 21:1431, 2003
- CLEATOR S et al: Triple-negative breast cancer: Therapeutic options. *Lancet Oncol* 8:235, 2007
- EARLY BREAST CANCER TRIALISTS' COLLABORATIVE GROUP: Effects of chemotherapy and hormonal therapy for early breast cancer on recurrence and 15-year survival: An overview of the randomised trials. *Lancet* 365:1687, 2005
- : Effects of radiotherapy and of differences in the extent of surgery for early breast cancer on local recurrence and 15-year survival: An overview of the randomised trials. *Lancet* 366:2087, 2005
- GIORDANO S et al: Breast cancer in men. *Ann Intern Med* 137:678, 2002
- INGLE JN et al: Fulvestrant in women with advanced breast cancer after progression on prior aromatase inhibitor therapy: North central cancer treatment group trial N0032. *J Clin Oncol* 24:1052, 2006
- JAKESZ R et al: Switching of postmenopausal women with endocrine-responsive early breast cancer to anastrozole after 2 years' adjuvant tamoxifen: Combined results of ABCSG trial 8 and ARNO 95 trial. *Lancet* 366:455, 2005
- JANNI W et al: Treatment of pregnancy-associated breast cancer. *Expert Opin Pharmacother* 10:2259, 2009
- MORENO-ASPITIA A, PEREZ EA: Treatment options for breast cancer resistant to anthracycline and taxane. *Mayo Clin Proc* 84:533, 2009
- PARTRIDGE A, SCHAPIRA L: Pregnancy and breast cancer. *Oncology* 19:693, 2005
- PEPPERCORN J: Breast cancer in women under 40. *Oncology* 23:530, 2009
- ROMOND EH et al: Trastuzumab plus adjuvant chemotherapy for operable HER2-positive breast cancer. *N Engl J Med* 353:1673, 2005
- SANTEN RJ, MANSEL R: Benign breast disorders. *N Engl J Med* 353:275, 2005
- SHAPIRO CL, WINER EL (eds): Late effects of treatment and survivorship issues in early-stage breast cancer. *Semin Oncol* 30:729, 2003
- SOTIRIOU C, PUSZTAI L: Gene-expression signatures in breast cancer. *N Engl J Med* 360:790, 2009





## CHAPTER 35

# GASTROINTESTINAL TRACT CANCER


Robert J. Mayer

■ Esophageal Cancer . . . . .	472	Hereditary Factors and Syndromes . . . . .	479
Incidence and Etiology . . . . .	472	Inflammatory Bowel Disease . . . . .	480
Clinical Features . . . . .	473	Other High-Risk Conditions . . . . .	480
Diagnosis . . . . .	473	Primary Prevention . . . . .	481
■ Tumors of the Stomach . . . . .	474	Screening . . . . .	481
Gastric Adenocarcinoma . . . . .	474	Clinical Features . . . . .	482
Primary Gastric Lymphoma . . . . .	477	■ Tumors of the Small Intestine . . . . .	485
Gastric (Nonlymphoid) Sarcoma . . . . .	477	Benign Tumors . . . . .	485
■ Colorectal Cancer . . . . .	477	Malignant Tumors . . . . .	486
Incidence . . . . .	477	Lymphomas . . . . .	486
Polyps and Molecular Pathogenesis . . . . .	478	■ Cancers of the Anus . . . . .	487
Etiology and Risk Factors . . . . .	478	■ Further Readings . . . . .	488

The gastrointestinal tract is the second most common noncutaneous site for cancer and the second major cause of cancer-related mortality in the United States.

## ESOPHAGEAL CANCER

### INCIDENCE AND ETIOLOGY

 Cancer of the esophagus is a relatively uncommon but extremely lethal malignancy. The diagnosis was made in 15,560 Americans in 2007 and led to 13,940 deaths. Worldwide, the incidence of esophageal cancer varies strikingly. It occurs frequently within a geographic region extending from the southern shore of the Caspian Sea on the west to northern China on the east and encompassing parts of Iran, Central Asia, Afghanistan, Siberia, and Mongolia. High-incidence pockets of the disease are also present in such disparate locations as Finland, Iceland, Curaçao, southeastern Africa, and northwestern France. In North America and western Europe, the disease is more common in blacks than whites and in males than females; it appears most often after age 50 and seems to be associated with a lower socioeconomic status.

A variety of causative factors have been implicated in the development of the disease ([Table 35-1](#)). In the

United States, esophageal cancer cases are either squamous cell carcinomas or adenocarcinomas. The etiology of squamous cell esophageal cancer is related to excess alcohol consumption and/or cigarette smoking. The relative risk increases with the amount of tobacco smoked or alcohol consumed, with these factors acting synergistically. The consumption of whiskey is linked to a higher incidence than the consumption of wine or beer. Squamous cell esophageal carcinoma has also been associated with the ingestion of nitrites, smoked opiates, and fungal toxins in pickled vegetables, as well as mucosal damage caused by such physical insults as long-term exposure to extremely hot tea, the ingestion of lye, radiation-induced strictures, and chronic achalasia. The presence of an esophageal web in association with glossitis and iron deficiency (i.e., Plummer-Vinson or Paterson-Kelly syndrome) and congenital hyperkeratosis and pitting of the palms and soles (i.e., tylosis palmaris et plantaris) have each been linked with squamous cell esophageal cancer, as have dietary deficiencies of molybdenum, zinc, and vitamin A.

For unclear reasons, the incidence of squamous cell esophageal cancer has decreased somewhat in both the black and white population in the United States over the past 30 years, whereas the rate of adenocarcinoma

TABLE 35-1

**SOME ETIOLOGIC FACTORS BELIEVED TO BE ASSOCIATED WITH ESOPHAGEAL CANCER**

Excess alcohol consumption
Cigarette smoking
Other ingested carcinogens
Nitrates (converted to nitrites)
Smoked opiates
Fungal toxins in pickled vegetables
Mucosal damage from physical agents
Hot tea
Lye ingestion
Radiation-induced strictures
Chronic achalasia
Host susceptibility
Esophageal web with glossitis and iron deficiency (i.e., Plummer-Vinson or Paterson-Kelly syndrome)
Congenital hyperkeratosis and pitting of the palms and soles (i.e., tylosis palmaris et plantaris)
? Dietary deficiencies molybdenum, zinc, vitamin A
? Celiac sprue
Chronic gastric reflux (i.e., Barrett's esophagus) for adenocarcinoma

has risen dramatically, particularly in white males. Adenocarcinomas arise in the distal esophagus in the presence of chronic gastric reflux and gastric metaplasia of the epithelium (Barrett's esophagus), which is more common in obese persons. Adenocarcinomas arise within dysplastic columnar epithelium in the distal esophagus. Even before frank neoplasia is detectable, aneuploidy and p53 mutations are found in the dysplastic epithelium. These adenocarcinomas behave clinically like gastric adenocarcinoma and now account for >60% of esophageal cancers.

## CLINICAL FEATURES

About 10% of esophageal cancers occur in the upper third of the esophagus (cervical esophagus), 35% in the middle third, and 55% in the lower third. Squamous cell carcinomas and adenocarcinomas cannot be distinguished radiographically or endoscopically.

Progressive dysphagia and weight loss of short duration are the initial symptoms in the vast majority of patients. Dysphagia initially occurs with solid foods and gradually progresses to include semisolids and liquids. By the time these symptoms develop, the disease is usually incurable because difficulty in swallowing does not occur until >60% of the esophageal circumference is infiltrated with cancer. Dysphagia may be associated with pain on swallowing (odynophagia), pain radiating to the chest and/or back, regurgitation or vomiting, and aspiration pneumonia. The disease most commonly spreads to adjacent and supraclavicular lymph nodes, liver, lungs, pleura, and bone. Tracheoesophageal fistulas may develop as the disease advances, leading to severe

suffering. As with other squamous cell carcinomas, hypercalcemia may occur in the absence of osseous metastases, probably from parathormone-related peptide secreted by tumor cells (Chap. 49).

## DIAGNOSIS

Attempts at endoscopic and cytologic screening for carcinoma in patients with Barrett's esophagus, although effective as a means of detecting high-grade dysplasia, have not yet been shown to improve the prognosis in individuals found to have a carcinoma. Routine contrast radiographs effectively identify esophageal lesions large enough to cause symptoms. In contrast to benign esophageal leiomyomas, which result in esophageal narrowing with preservation of a normal mucosal pattern, esophageal carcinomas show ragged, ulcerating changes in the mucosa in association with deeper infiltration, producing a picture resembling achalasia. Smaller, potentially resectable tumors are often poorly visualized despite technically adequate esophagograms. Because of this, esophagoscopy should be performed in all patients suspected of having an esophageal abnormality, to visualize the tumor and to obtain histopathologic confirmation of the diagnosis. Because the population of persons at risk for squamous cell carcinoma of the esophagus (i.e., smokers and drinkers) also has a high rate of cancers of the lung and the head and neck region, endoscopic inspection of the larynx, trachea, and bronchi should also be done. A thorough examination of the fundus of the stomach (by retroflexing the endoscope) is imperative as well. Endoscopic biopsies of esophageal tumors fail to recover malignant tissue in a third of cases because the biopsy forceps cannot penetrate deeply enough through normal mucosa pushed in front of the carcinoma. Cytologic examination of tumor brushings complements standard biopsies and should be performed routinely. The extent of tumor spread to the mediastinum and para-aortic lymph nodes should be assessed by CT scans of the chest and abdomen and by endoscopic ultrasound. Positron emission tomography scanning provides a useful assessment of resectability, offering accurate information regarding spread to mediastinal lymph nodes.

### **Rx Treatment:** **ESOPHAGEAL CANCER**

The prognosis for patients with esophageal carcinoma is poor. Fewer than 5% of patients survive 5 years after the diagnosis; thus management focuses on symptom control. Surgical resection of all gross tumor (i.e., total resection) is feasible in only 45% of cases, with residual tumor cells frequently present at the resection margins. Such esophagectomies have been associated with a postoperative mortality rate of 5–10% due to anastomotic

fistulas, subphrenic abscesses, and respiratory complications. About 20% of patients who survive a total resection live 5 years. The efficacy of primary radiation therapy (5500–6000 cGy) for squamous cell carcinomas is similar to that of radical surgery, sparing patients perioperative morbidity but often resulting in less satisfactory palliation of obstructive symptoms. The evaluation of chemotherapeutic agents in patients with esophageal carcinoma has been hampered by ambiguity in the definition of “response” and the debilitated physical condition of many treated individuals. Nonetheless, significant reductions in the size of measurable tumor masses have been reported in 15–25% of patients given single-agent treatment and in 30–60% of patients treated with drug combinations that include cisplatin. Combination chemotherapy and radiation therapy as the initial therapeutic approach, either alone or followed by an attempt at operative resection, seems to be beneficial. When administered along with radiation therapy, chemotherapy produces a better survival outcome than radiation therapy alone. The use of preoperative chemotherapy and radiation therapy followed by esophageal resection appears to prolong survival as compared with controls in small randomized trials, and some reports suggest that no additional benefit accrues when surgery is added if significant shrinkage of tumor has been achieved by the chemoradiation combination.

For the incurable, surgically unresectable patient with esophageal cancer, dysphagia, malnutrition, and the management of tracheoesophageal fistulas are major issues. Approaches to palliation include repeated endoscopic dilatation, the surgical placement of a gastrostomy or jejunostomy for hydration and feeding, and endoscopic placement of an expansive metal stent to bypass the tumor. Endoscopic fulguration of the obstructing tumor with lasers is the most promising of these techniques.

## TUMORS OF THE STOMACH

### GASTRIC ADENOCARCINOMA

#### Incidence and Epidemiology



For unclear reasons, the incidence and mortality rates for gastric cancer have decreased markedly during the past 75 years. The mortality rate from gastric cancer in the United States has dropped in men from 28 to 5.8 per 100,000 persons, and in women the rate has decreased from 27 to 2.8 per 100,000. Nonetheless, 21,260 new cases of stomach cancer were diagnosed in the United States, and 11,210 Americans died of the disease in 2007. Gastric cancer incidence has decreased worldwide but remains high in Japan, China, Chile, and Ireland.

The risk of gastric cancer is greater among lower socioeconomic classes. Migrants from high- to low-incidence nations maintain their susceptibility to gastric cancer, whereas the risk for their offspring approximates that of the new homeland. These findings suggest that an environmental exposure, probably beginning early in life, is related to the development of gastric cancer, with dietary carcinogens considered the most likely factor(s).

#### Pathology

About 85% of stomach cancers are adenocarcinomas, with 15% due to lymphomas and gastrointestinal stromal tumors (GIST) and leiomyosarcomas. Gastric adenocarcinomas may be subdivided into two categories: a *diffuse type*, in which cell cohesion is absent, so that individual cells infiltrate and thicken the stomach wall without forming a discrete mass; and an *intestinal type*, characterized by cohesive neoplastic cells that form glandlike tubular structures. The diffuse carcinomas occur more often in younger patients, develop throughout the stomach (including the cardia), result in a loss of distensibility of the gastric wall (so-called linitis plastica, or “leather bottle” appearance), and carry a poorer prognosis. Intestinal-type lesions are frequently ulcerative, more commonly appear in the antrum and lesser curvature of the stomach, and they are often preceded by a prolonged precancerous process. Although the incidence of diffuse carcinomas is similar in most populations, the intestinal type tends to predominate in the high-risk geographic regions and is less likely to be found in areas where the frequency of gastric cancer is declining. Thus different etiologic factor(s) may be involved in these two subtypes. In the United States, ~30% of gastric cancers originate in the distal stomach, ~20% arise in the mid-portion of the stomach, and ~37% originate in the proximal third of the stomach. The remaining 13% involve the entire stomach.

#### Etiology

The long-term ingestion of high concentrations of nitrates in dried, smoked, and salted foods appears to be associated with a higher risk. The nitrates are thought to be converted to carcinogenic nitrites by bacteria (Table 35-2). Such bacteria may be introduced exogenously through the ingestion of partially decayed foods, which are consumed in abundance worldwide by the lower socioeconomic classes. Bacteria such as *Helicobacter pylori* may also contribute to this effect by causing chronic gastritis, loss of gastric acidity, and bacterial growth in the stomach. The effect of *H. pylori* eradication on the subsequent risk for gastric cancer in high-incidence areas is under investigation. Loss of acidity may occur when acid-producing cells of the gastric antrum have been removed surgically to control benign

TABLE 35-2

**NITRATE-CONVERTING BACTERIA AS A FACTOR IN THE CAUSATION OF GASTRIC CARCINOMA<sup>a</sup>**

Exogenous sources of nitrate-converting bacteria:
Bacterially contaminated food (common in lower socioeconomic classes, who have a higher incidence of the disease; diminished by improved food preservation and refrigeration)
? <i>Helicobacter pylori</i> infection
Endogenous factors favoring growth of nitrate-converting bacteria in the stomach:
Decreased gastric acidity
Prior gastric surgery (antrectomy) (15- to 20-year latency period)
Atrophic gastritis and/or pernicious anemia
? Prolonged exposure to histamine H <sub>2</sub> -receptor antagonists

<sup>a</sup>Hypothesis: Dietary nitrates are converted to carcinogenic nitrites by bacteria.

peptic ulcer disease or when achlorhydria, atrophic gastritis, and even pernicious anemia develop in the elderly. Serial endoscopic examinations of the stomach in patients with atrophic gastritis have documented replacement of the usual gastric mucosa by intestinal-type cells. This process of intestinal metaplasia may lead to cellular atypia and eventual neoplasia. Because the declining incidence of gastric cancer in the United States primarily reflects a decline in distal, ulcerating, intestinal-type lesions, it is conceivable that better food preservation and the availability of refrigeration to all socioeconomic classes have decreased the dietary ingestion of exogenous bacteria. *H. pylori* have not been associated with the diffuse, more proximal form of gastric carcinoma.

Several additional etiologic factors have been associated with gastric carcinoma. Gastric ulcers and adenomatous polyps have occasionally been linked, but data on a cause-and-effect relationship are unconvincing. The inadequate clinical distinction between benign gastric ulcers and small ulcerating carcinomas may, in part, account for this presumed association. The presence of extreme hypertrophy of gastric rugal folds (i.e., Ménétrier's disease), giving the impression of polypoid lesions, has been associated with a striking frequency of malignant transformation; such hypertrophy, however, does not represent the presence of true adenomatous polyps. Individuals with blood group A have a higher incidence of gastric cancer than persons with blood group O; this observation may be related to differences in the mucous secretion, leading to altered mucosal protection from carcinogens. A germline mutation in the E-cadherin gene, inherited in an autosomal dominant pattern and coding for a cell adhesion protein, has been linked to a high incidence of occult gastric cancers in young asymptomatic carriers. Duodenal ulcers are not associated with gastric cancer.

**Clinical Features**

Gastric cancers, when superficial and surgically curable, usually produce no symptoms. As the tumor becomes more extensive, patients may complain of an insidious upper abdominal discomfort varying in intensity from a vague, postprandial fullness to a severe, steady pain. Anorexia, often with slight nausea, is very common but is not the usual presenting complaint. Weight loss may eventually be observed, and nausea and vomiting are particularly prominent with tumors of the pylorus; dysphagia and early satiety may be the major symptoms caused by diffuse lesions originating in the cardia. There are no early physical signs. A palpable abdominal mass indicates long-standing growth and predicts regional extension.

Gastric carcinomas spread by direct extension through the gastric wall to the perigastric tissues, occasionally adhering to adjacent organs such as the pancreas, colon, or liver. The disease also spreads via lymphatics or by seeding of peritoneal surfaces. Metastases to intraabdominal and supraclavicular lymph nodes occur frequently, as do metastatic nodules to the ovary (Krukenberg's tumor), periumbilical region ("Sister Mary Joseph node"), or peritoneal cul-de-sac (Blumer's shelf palpable on rectal or vaginal examination); malignant ascites may also develop. The liver is the most common site for hematogenous spread of tumor.

The presence of iron-deficiency anemia in men and of occult blood in the stool in both sexes mandates a search for an occult gastrointestinal tract lesion. A careful assessment is of particular importance in patients with atrophic gastritis or pernicious anemia. Unusual clinical features associated with gastric adenocarcinomas include migratory thrombophlebitis, microangiopathic hemolytic anemia, and acanthosis nigricans.

**Diagnosis**

A double-contrast radiographic examination is the simplest diagnostic procedure for the evaluation of a patient with epigastric complaints. The use of double-contrast techniques helps to detect small lesions by improving mucosal detail. The stomach should be distended at some time during every radiographic examination because decreased distensibility may be the only indication of a diffuse infiltrative carcinoma. Although gastric ulcers can be detected fairly early, distinguishing benign from malignant lesions radiographically is difficult. The anatomic location of an ulcer is not in itself an indication of the presence or absence of a cancer.

Gastric ulcers that appear benign by radiography present special problems. Some physicians believe that gastroscopy is not mandatory if the radiographic features are typically benign, if complete healing can be visualized by x-ray within 6 weeks, and if a follow-up contrast radiograph obtained several months later shows a normal appearance. However, we recommend gastroscopic

## STAGING SYSTEM FOR GASTRIC CARCINOMA

STAGE	TNM	FEATURES	DATA FROM ACS	
			NO. OF CASES, %	5-YEAR SURVIVAL, %
0	TisN0M0	Node negative; limited to mucosa	1	90
IA	T1N0M0	Node negative; invasion of lamina propria or submucosa	7	59
IB	T2N0M0	Node negative; invasion of muscularis propria	10	44
II	T1N2M0 T2N1M0	Node positive; invasion beyond mucosa but within wall	17	29
		<i>or</i>		
IIIA	T3N0M0 T2N2M0 T3N1-2M0	Node negative; extension through wall Node positive; invasion of muscularis propria or through wall	21	15
IIIB	T4N0-1M0	Node negative; adherence to surrounding tissue	14	9
IV	T4N2M0	Node positive; adherence to surrounding tissue	30	3
		<i>or</i>		
	T1-4N0-2M1	Distant metastases		

**Note:** ACS, American Cancer Society.

biopsy and brush cytology for all patients with a gastric ulcer in order to exclude a malignancy. Malignant gastric ulcers must be recognized before they penetrate into surrounding tissues because the rate of cure of early lesions limited to the mucosa or submucosa is >80%. Because gastric carcinomas are difficult to distinguish clinically or radiographically from gastric lymphomas, endoscopic biopsies should be made as deeply as possible, due to the submucosal location of lymphoid tumors. The staging system for gastric carcinoma is shown in [Table 35-3](#).

### **Rx** Treatment: GASTRIC ADENOCARCINOMA

Complete surgical removal of the tumor with resection of adjacent lymph nodes offers the only chance for cure. However, this is possible in less than a third of patients. A subtotal gastrectomy is the treatment of choice for patients with distal carcinomas; total or near-total gastrectomies are required for more proximal tumors. The inclusion of extended lymph node dissection in these procedures appears to confer an added risk for complications without enhancing survival. The prognosis following complete surgical resection depends on the degree of tumor penetration into the stomach wall and is adversely influenced by regional lymph node involvement, vascular invasion, and abnormal DNA content (i.e., aneuploidy), characteristics found in the vast majority of American patients. As a result, the probability of survival after 5 years for the 25–30% of patients able to undergo complete resection is ~20% for distal tumors and <10% for proximal tumors, with recurrences

continuing for at least 8 years after surgery. In the absence of ascites or extensive hepatic or peritoneal metastases, even patients whose disease is believed to be incurable by surgery should be offered resection of the primary lesion. Reduction of tumor bulk is the best form of palliation and may enhance the probability of benefit from subsequent therapy.

Gastric adenocarcinoma is a relatively radioresistant tumor, and adequate control of the primary tumor requires doses of external beam irradiation that exceed the tolerance of surrounding structures, such as bowel mucosa and spinal cord. As a result, the major role of radiation therapy in patients has been palliation of pain. Radiation therapy alone after a complete resection does not prolong survival. In the setting of surgically unresectable disease limited to the epigastrium, patients treated with 3500–4000 cGy did not live longer than similar patients not receiving radiotherapy; however, survival was prolonged slightly when 5-fluorouracil (5-FU) was given in combination with radiation therapy. In this clinical setting, the 5-FU may be functioning as a radiosensitizer.

The administration of combinations of cytotoxic drugs to patients with advanced gastric carcinoma has been associated with partial responses in 30–50% of cases; responders appear to benefit from treatment. Such drug combinations have generally included cisplatin combined with epirubicin and infusional 5-FU or with irinotecan. Despite this encouraging response rate, complete remissions are uncommon, the partial responses are transient, and the overall influence of multidrug therapy on survival has been unclear. The use of adjuvant chemotherapy alone following the complete

resection of a gastric cancer has only minimally improved survival. However, combination chemotherapy administered before and after surgery (*perioperative treatment*) as well as postoperative chemotherapy combined with radiation therapy reduces the recurrence rate and prolongs survival.

## PRIMARY GASTRIC LYMPHOMA

Primary lymphoma of the stomach is relatively uncommon, accounting for <15% of gastric malignancies and ~2% of all lymphomas. The stomach is, however, the most frequent extranodal site for lymphoma, and gastric lymphoma has increased in frequency during the past 30 years. The disease is difficult to distinguish clinically from gastric adenocarcinoma; both tumors are most often detected during the sixth decade of life; present with epigastric pain, early satiety, and generalized fatigue; and are usually characterized by ulcerations with a ragged, thickened mucosal pattern demonstrated by contrast radiographs. The diagnosis of lymphoma of the stomach may occasionally be made through cytologic brushings of the gastric mucosa but usually requires a biopsy at gastroscopy or laparotomy. Failure of gastroscopic biopsies to detect lymphoma in a given case should not be interpreted as conclusive because superficial biopsies may miss the deeper lymphoid infiltrate. The macroscopic pathology of gastric lymphoma may also mimic adenocarcinoma, consisting of either a bulky ulcerated lesion localized in the corpus or antrum or a diffuse process spreading throughout the entire gastric submucosa and even extending into the duodenum. Microscopically, the vast majority of gastric lymphoid tumors are non-Hodgkin's lymphomas of B cell origin; Hodgkin's disease involving the stomach is extremely uncommon. Histologically, these tumors may range from well-differentiated, superficial processes [mucosa-associated lymphoid tissue (MALT)] to high-grade, large-cell lymphomas. Like gastric adenocarcinoma, infection with *H. pylori* increases the risk for gastric lymphoma in general and MALT lymphomas in particular. Gastric lymphomas spread initially to regional lymph nodes (often to Waldeyer's ring) and may then disseminate. Gastric lymphomas are staged like other lymphomas (Chap. 15).

### **Rx** Treatment: PRIMARY GASTRIC LYMPHOMA

Primary gastric lymphoma is a far more treatable disease than adenocarcinoma of the stomach, a fact that underscores the need for making the correct diagnosis. Antibiotic treatment to eradicate *H. pylori* infection has led to regression of ~75% of gastric MALT lymphomas

and should be considered before surgery, radiation therapy, or chemotherapy are undertaken in patients having such tumors. A lack of response to such antimicrobial treatment has been linked to a specific chromosomal abnormality, i.e., t(11;18). Responding patients should undergo periodic endoscopic surveillance because it remains unclear whether the neoplastic clone is eliminated or merely suppressed, although the response to antimicrobial treatment is quite durable. Subtotal gastrectomy, usually followed by combination chemotherapy, has led to 5-year survival rates of 40–60% in patients with localized high-grade lymphomas. The need for a major surgical procedure has been questioned, particularly in patients with preoperative radiographic evidence of nodal involvement, for whom chemotherapy [CHOP (cyclophosphamide, doxorubicin, vincristine, and prednisone)] plus rituximab is effective therapy. A role for radiation therapy is not defined because most recurrences develop at distant sites.

## GASTRIC (NONLYMPHOID) SARCOMA

Leiomyosarcomas and GISTs make up 1–3% of gastric neoplasms. They most frequently involve the anterior and posterior walls of the gastric fundus and often ulcerate and bleed. Even those lesions that appear benign on histologic examination may behave in a malignant fashion. These tumors rarely invade adjacent viscera and characteristically do not metastasize to lymph nodes, but they may spread to the liver and lungs. The treatment of choice is surgical resection. Combination chemotherapy should be reserved for patients with metastatic disease. All such tumors should be analyzed for a mutation in the *c-kit* receptor. GISTs are unresponsive to conventional chemotherapy; ~50% of patients experience objective response and prolonged survival when treated with imatinib mesylate (Gleevec) (400–800 mg PO daily), a selective inhibitor of the *c-kit* tyrosine kinase. Many patients with GIST whose tumors have become refractory to imatinib subsequently benefit from sunitinib (Sutent), another inhibitor of the *c-kit* tyrosine kinase.

## COLORECTAL CANCER

### INCIDENCE

Cancer of the large bowel is second only to lung cancer as a cause of cancer death in the United States: 153,760 new cases occurred in 2007, and 52,180 deaths were due to colorectal cancer. The incidence rate has remained relatively unchanged during the past 30 years, although the mortality rate has decreased, particularly in women. Colorectal cancer generally occurs in persons ≥50 years of age.

Most colorectal cancers, regardless of etiology, arise from adenomatous polyps. A polyp is a grossly visible protrusion from the mucosal surface and may be classified pathologically as a nonneoplastic hamartoma (*juvenile polyp*), a hyperplastic mucosal proliferation (*hyperplastic polyp*), or an adenomatous polyp. Only adenomas are clearly premalignant, and only a minority of such lesions becomes cancer. Adenomatous polyps may be found in the colons of ~30% of middle-aged and ~50% of elderly people; however, <1% of polyps ever become malignant. Most polyps produce no symptoms and remain clinically undetected. Occult blood in the stool is found in <5% of patients with polyps.

A number of molecular changes are noted in adenomatous polyps, dysplastic lesions, and polyps containing microscopic foci of tumor cells (carcinoma in situ), which are thought to reflect a multistep process in the evolution of normal colonic mucosa to life-threatening invasive carcinoma. These developmental steps toward carcinogenesis include, but are not restricted to, point mutations in the *K-ras* protooncogene; hypomethylation of DNA, leading to gene activation; loss of DNA (*allelic loss*) at the site of a tumor-suppressor gene [the adenomatous polyposis coli (*APC*) gene] on the long arm of chromosome 5 (5q21); allelic loss at the site of a tumor-suppressor gene located on chromosome 18q [the deleted in colorectal cancer (*DCC*) gene]; and allelic loss at chromosome 17p, associated with mutations in the p53 tumor-suppressor gene (see Fig. 23-2). Thus the altered proliferative pattern of the colonic mucosa, which results in progression to a polyp and then to carcinoma, may involve the mutational activation of an oncogene followed by and coupled with the loss of genes that normally suppress tumorigenesis. It remains uncertain whether the genetic aberrations always occur in a defined order. Based on this model, however, cancer is believed to develop only in those polyps in which most (if not all) of these mutational events take place.

Clinically, the probability of an adenomatous polyp becoming a cancer depends on the gross appearance of the lesion, its histologic features, and its size. Adenomatous polyps may be pedunculated (stalked) or sessile (flat-based). Cancers develop more frequently in sessile polyps. Histologically, adenomatous polyps may be tubular, villous (i.e., papillary), or tubulovillous. Villous adenomas, most of which are sessile, become malignant more than three times as often as tubular adenomas. The likelihood that any polypoid lesion in the large bowel contains invasive cancer is related to the size of the polyp, being negligible (<2%) in lesions <1.5 cm, intermediate (2–10%) in lesions 1.5–2.5 cm in size, and substantial (10%) in lesions >2.5 cm.

Following the detection of an adenomatous polyp, the entire large bowel should be visualized endoscopically or

radiographically because synchronous lesions are noted in about a third of cases. Colonoscopy should then be repeated periodically, even in the absence of a previously documented malignancy, because such patients have a 30–50% probability of developing another adenoma and are at a higher-than-average risk for developing a colorectal carcinoma. Adenomatous polyps are thought to require >5 years of growth before becoming clinically significant; colonoscopy need not be carried out more frequently than every 3 years.

## ETIOLOGY AND RISK FACTORS



Risk factors for the development of colorectal cancer are listed in [Table 35-4](#).

### Diet

The etiology for most cases of large-bowel cancer appears to be related to environmental factors. The disease occurs more often in upper socioeconomic populations who live in urban areas. Mortality from colorectal cancer is directly correlated with per capita consumption of calories, meat protein, and dietary fat and oil as well as elevations in the serum cholesterol concentration and mortality from coronary artery disease. Geographic variations in incidence are unrelated to genetic differences because migrant groups tend to assume the large-bowel cancer incidence rates of their adopted countries. Furthermore, population groups such as Mormons and Seventh Day Adventists, whose lifestyle and dietary habits differ somewhat from those of their neighbors, have significantly lower-than-expected incidence and mortality rates for colorectal cancer. Colorectal cancer has increased in Japan since that nation has adopted a more “Western” diet. At least three hypotheses have been proposed to explain the relationship to diet, none of which is fully satisfactory.

### Animal Fats

One hypothesis is that the ingestion of animal fats found in red meats and processed meat leads to an increased proportion of anaerobes in the gut microflora, resulting

**TABLE 35-4**

### RISK FACTORS FOR THE DEVELOPMENT OF COLORECTAL CANCER

Diet: Animal fat
Hereditary syndromes (autosomal dominant inheritance)
Polyposis coli
Nonpolyposis syndrome (Lynch's syndrome)
Inflammatory bowel disease
<i>Streptococcus bovis</i> bacteremia
Ureterosigmoidostomy
? Tobacco use

in the conversion of normal bile acids into carcinogens. This provocative hypothesis is supported by several reports of increased amounts of fecal anaerobes in the stools of patients with colorectal cancer. Diets high in animal (but not vegetable) fats are also associated with high serum cholesterol, which is also associated with enhanced risk for the development of colorectal adenomas and carcinomas.

### Insulin Resistance

The large number of calories in “Western” diets coupled with physical inactivity has been associated with a higher prevalence of obesity. Obese persons develop insulin resistance with increased circulating levels of insulin, leading to higher circulating concentrations of insulin-like growth factor type I (IGF-I). This growth factor appears to stimulate proliferation of the intestinal mucosa.

### Fiber

Contrary to prior beliefs, the results of randomized trials and case-controlled studies have failed to show any value for dietary fiber or diets high in fruits and vegetables in preventing the recurrence of colorectal adenomas or the development of colorectal cancer. The weight of epidemiologic evidence, however, implicates diet as the major etiologic factor for colorectal cancer, particularly diets high in animal fat and in calories.

## HEREDITARY FACTORS AND SYNDROMES

Up to 25% of patients with colorectal cancer have a family history of the disease, suggesting a hereditary

predisposition. Inherited large-bowel cancers can be divided into two main groups: the well-studied but uncommon polyposis syndromes and the more common nonpolyposis syndromes (Table 35-5).

### Polyposis Coli

Polyposis coli (familial polyposis of the colon) is a rare condition characterized by the appearance of thousands of adenomatous polyps throughout the large bowel. It is transmitted as an autosomal dominant trait; the occasional patient with no family history probably developed the condition due to a spontaneous mutation. Polyposis coli is associated with a deletion in the long arm of chromosome 5 [including the *APC* (adenomatous polyposis coli) gene] in both neoplastic (somatic mutation) and normal (germline mutation) cells. The loss of this genetic material (i.e., allelic loss) results in the absence of tumor-suppressor genes whose protein products would normally inhibit neoplastic growth. The presence of soft tissue and bony tumors, congenital hypertrophy of the retinal pigment epithelium, mesenteric desmoid tumors, and ampullary cancers in addition to the colonic polyps characterizes a subset of polyposis coli known as *Gardner's syndrome*. The appearance of malignant tumors of the central nervous system accompanying polyposis coli defines *Turcot's syndrome*. The colonic polyps in all these conditions are rarely present before puberty but are generally evident in affected individuals by age 25. If the polyposis is not treated surgically, colorectal cancer will develop in almost all patients before age 40. Polyposis coli results from a defect in the colonic mucosa, leading to an abnormal proliferative pattern and impaired DNA

TABLE 35-5

HEREDITABLE (AUTOSOMAL DOMINANT) GASTROINTESTINAL POLYPOSIS SYNDROMES

SYNDROME	DISTRIBUTION OF POLYPS	HISTOLOGIC TYPE	MALIGNANT POTENTIAL	ASSOCIATED LESIONS
Familial adenomatous polyposis	Large intestine	Adenoma	Common	None
Gardner's syndrome	Large and small intestines	Adenoma	Common	Osteomas, fibromas, lipomas, epidermoid cysts, ampullary cancers, congenital hypertrophy of retinal pigment epithelium
Turcot's syndrome	Large intestine	Adenoma	Common	Brain tumors
Nonpolyposis syndrome (Lynch syndrome)	Large intestine (often proximal)	Adenoma	Common	Endometrial and ovarian tumors
Peutz-Jeghers syndrome	Small and large intestines, stomach	Hamartoma	Rare	Mucocutaneous pigmentation; tumors of the ovary, breast, pancreas, endometrium
Juvenile polyposis	Large and small intestines, stomach	Hamartoma, rarely progressing to adenoma	Rare	Various congenital abnormalities



repair mechanisms. Once the multiple polyps are detected, patients should undergo a total colectomy. The ileoanal anastomotic technique allows removal of the entire bowel while retaining the anal sphincter. Medical therapy with nonsteroidal anti-inflammatory drugs (NSAIDs) such as sulindac and cyclooxygenase-2 inhibitors such as celecoxib can decrease the number and size of polyps in patients with polyposis coli; however, this effect on polyps is only temporary, and NSAIDs are not proven to reduce the risk of cancer. Colectomy remains the primary therapy/prevention. The offspring of patients with polyposis coli, who often are prepubertal when the diagnosis is made in the parent, have a 50% risk for developing this premalignant disorder and should be carefully screened by annual flexible sigmoidoscopy until age 35. Proctosigmoidoscopy is a sufficient screening procedure because polyps tend to be evenly distributed from cecum to anus, making more invasive and expensive techniques such as colonoscopy or barium enema unnecessary. Testing for occult blood in the stool is an inadequate screening maneuver. An alternative method for identifying carriers is testing DNA from peripheral blood mononuclear cells for the presence of a mutated *APC* gene. The detection of such a germline mutation can lead to a definitive diagnosis before the development of polyps.

### **Hereditary Nonpolyposis Colon Cancer**

Hereditary nonpolyposis colon cancer (HNPCC), also known as *Lynch's syndrome*, is another autosomal dominant trait. It is characterized by the presence of three or more relatives with histologically documented colorectal cancer, one of whom is a first-degree relative of the other two; one or more cases of colorectal cancer diagnosed before age 50 in the family; and colorectal cancer involving at least two generations. In contrast to polyposis coli, HNPCC is associated with an unusually high frequency of cancer arising in the proximal large bowel. The median age for the appearance of an adenocarcinoma is <50 years, 10–15 years younger than the median age for the general population. Despite having a poorly differentiated histologic appearance, the proximal colon tumors in HNPCC have a better prognosis than sporadic tumors from patients of similar age. Families with HNPCC often include individuals with multiple primary cancers; the association of colorectal cancer with either ovarian or endometrial carcinomas is especially strong in women. It has been recommended that members of such families undergo biennial colonoscopy beginning at age 25 years, with intermittent pelvic ultrasonography and endometrial biopsy for afflicted women; such a screening strategy has not yet been validated. HNPCC is associated with germline mutations of several genes, particularly *hMSH2* on chromosome 2 and *hMLH1* on chromosome 3. These mutations lead to

errors in DNA replication and are thought to result in DNA instability because of defective repair of DNA mismatches, resulting in abnormal cell growth and tumor development. Testing tumor cells through molecular analysis of DNA or immunohistochemical staining of paraffin-fixed tissue for “microsatellite instability” (sequence changes reflecting defective mismatch repair) in patients <50 years of age with colorectal cancer and a positive family history for colorectal or endometrial cancer may identify probands with HNPCC.

## **INFLAMMATORY BOWEL DISEASE**

Large-bowel cancer is increased in incidence in patients with long-standing inflammatory bowel disease (IBD). Cancers develop more commonly in patients with ulcerative colitis than in those with granulomatous colitis, but this impression may result in part from the occasional difficulty of differentiating these two conditions. The risk of colorectal cancer in a patient with IBD is relatively small during the initial 10 years of the disease, but then it appears to increase at a rate of ~0.5–1% per year. Cancer may develop in 8–30% of patients after 25 years. The risk is higher in younger patients with pancolitis.

Cancer surveillance in patients with IBD is unsatisfactory. Symptoms such as bloody diarrhea, abdominal cramping, and obstruction, which may signal the appearance of a tumor, are similar to the complaints caused by a flare-up of the underlying disease. In patients with a history of IBD lasting  $\geq 15$  years who continue to experience exacerbations, the surgical removal of the colon can significantly reduce the risk for cancer and also eliminate the target organ for the underlying chronic gastrointestinal disorder. The value of such surveillance techniques as colonoscopy with mucosal biopsies and brushings for less symptomatic individuals with chronic IBD is uncertain. The lack of uniformity regarding the pathologic criteria that characterize dysplasia and the absence of data that such surveillance reduces the development of lethal cancers have made this costly practice an area of controversy.

## **OTHER HIGH-RISK CONDITIONS**

### ***Streptococcus bovis* Bacteremia**

For unknown reasons, individuals who develop endocarditis or septicemia from this fecal bacterium have a high incidence of occult colorectal tumors and, possibly, upper gastrointestinal cancers as well. Endoscopic or radiographic screening appears advisable.

### **Tobacco Use**

Cigarette smoking is linked to the development of colorectal adenomas, particularly after >35 years of tobacco

use. No biologic explanation for this association has yet been proposed.

## PRIMARY PREVENTION

Several orally administered compounds have been assessed as possible inhibitors of colon cancer. The most effective class of chemopreventive agents is aspirin and other NSAIDs, which are thought to suppress cell proliferation by inhibiting prostaglandin synthesis. Regular aspirin use reduces the risk of colon adenomas and carcinomas as well as death from large-bowel cancer; such use also appears to diminish the likelihood for developing additional premalignant adenomas following treatment for a prior colon carcinoma. This effect of aspirin on colon carcinogenesis increases with the duration and dosage of drug use. Oral folic acid supplements and oral calcium supplements reduce the risk of adenomatous polyps and colorectal cancers in case-controlled studies. Antioxidant vitamins such as ascorbic acid, tocopherols, and  $\beta$ -carotene are ineffective at reducing the incidence of subsequent adenomas in patients who have undergone the removal of a colon adenoma. Estrogen-replacement therapy has been associated with a reduction in the risk of colorectal cancer in women, conceivably by an effect on bile acid synthesis and composition or by decreasing synthesis of IGF-I. The otherwise unexplained reduction in colorectal cancer mortality in women may be a result of the widespread use of estrogen replacement in postmenopausal individuals.

## SCREENING

The rationale for colorectal cancer screening programs is that earlier detection of localized, superficial cancers in asymptomatic individuals will increase the surgical cure rate. Such screening programs are important for individuals having a family history of the disease in first-degree relatives. The relative risk for developing colorectal cancer increases to 1.75 in such individuals and may be even higher if the relative was afflicted before age 60. The prior use of proctosigmoidoscopy as a screening tool was based on the observation that 60% of early lesions are located in the rectosigmoid. For unexplained reasons, however, the proportion of large-bowel cancers arising in the rectum has been decreasing during the past several decades, with a corresponding increase in the proportion of cancers in the more proximal descending colon. As such, the potential for rigid proctosigmoidoscopy to detect a sufficient number of occult neoplasms to make the procedure cost-effective has been questioned. Flexible, fiberoptic sigmoidoscopes permit trained operators to visualize the colon for up to 60 cm, which enhances the capability for cancer detection. However, this technique still leaves the proximal half of the large bowel unscreened.

Most programs directed at the early detection of colorectal cancers have focused on digital rectal examinations and fecal occult blood testing. The digital examination should be part of any routine physical evaluation in adults older than age 40, serving as a screening test for prostate cancer in men, a component of the pelvic examination in women, and an inexpensive maneuver for the detection of masses in the rectum. The development of the Hemoccult test has greatly facilitated the detection of occult fecal blood. Unfortunately, even when performed optimally, the Hemoccult test has major limitations as a screening technique. About 50% of patients with documented colorectal cancers have a negative fecal Hemoccult test, consistent with the intermittent bleeding pattern of these tumors. When random cohorts of asymptomatic persons have been tested, 2–4% have Hemoccult-positive stools. Colorectal cancers have been found in <10% of these “test-positive” cases, with benign polyps detected in an additional 20–30%. Thus a colorectal neoplasm will not be found in most asymptomatic individuals with occult blood in their stool. Nonetheless, persons found to have Hemoccult-positive stool routinely undergo further medical evaluation, including sigmoidoscopy, barium enema, and/or colonoscopy—procedures that are not only uncomfortable and expensive but also associated with a small risk for significant complications. The added cost of these studies would appear justifiable if the small number of patients found to have occult neoplasms because of Hemoccult screening could be shown to have an improved prognosis and prolonged survival. Prospectively controlled trials showed a statistically significant reduction in mortality from colorectal cancer for individuals undergoing annual screening. However, this benefit only emerged after >13 years of follow-up and was extremely expensive to achieve because all positive tests (most of which were false positive) were followed by colonoscopy. Moreover, these colonoscopic examinations quite likely provided the opportunity for cancer prevention through the removal of potentially premalignant adenomatous polyps because the eventual development of cancer was reduced by 20% in the cohort undergoing annual screening.

Screening techniques for large-bowel cancer in asymptomatic persons remain unsatisfactory. Compliance with any screening strategy within the general population is poor. At present, the American Cancer Society suggests fecal Hemoccult screening annually and flexible sigmoidoscopy every 5 years beginning at age 50 for asymptomatic individuals having no colorectal cancer risk factors. The American Cancer Society has also endorsed a “total colon examination” (i.e., colonoscopy or double-contrast barium enema) every 10 years as an alternative to Hemoccult testing with periodic flexible sigmoidoscopy. Colonoscopy has been shown to be superior to double-contrast barium enema and also to

482 have a higher sensitivity for detecting villous or dysplastic adenomas or cancers than the strategy employing occult fecal blood testing and flexible sigmoidoscopy. Whether colonoscopy performed every 10 years beginning after age 50 will prove to be cost-effective and whether it may be supplanted as a screening maneuver by sophisticated radiographic techniques (“virtual colonoscopy”) remains unclear. More effective techniques for screening are needed, perhaps taking advantage of the molecular changes that have been described in these tumors. Analysis of fecal DNA for multiple mutations associated with colorectal cancer is being tested.

## CLINICAL FEATURES

### Presenting Symptoms

Symptoms vary with the anatomic location of the tumor. Because stool is relatively liquid as it passes through the ileocecal valve into the right colon, cancers arising in the cecum and ascending colon may become quite large without resulting in any obstructive symptoms or noticeable alterations in bowel habits. Lesions of the right colon commonly ulcerate, leading to chronic, insidious blood loss without a change in the appearance of the stool. Consequently, patients with tumors of the ascending colon often present with symptoms such as fatigue, palpitations, and even angina pectoris and are found to have a hypochromic, microcytic anemia indicative of iron deficiency. Because the cancer may bleed intermittently, a random fecal occult blood test may be negative. As a result, the unexplained presence of

iron-deficiency anemia in any adult (with the possible exception of a premenopausal, multiparous woman) mandates a thorough endoscopic and/or radiographic visualization of the entire large bowel (Fig. 35-1).

Because stool becomes more formed as it passes into the transverse and descending colon, tumors arising there tend to impede the passage of stool, resulting in the development of abdominal cramping, occasional obstruction, and even perforation. Radiographs of the abdomen often reveal characteristic annular, constricting lesions (“apple-core” or “napkin-ring”) (Fig. 35-2).

Cancers arising in the rectosigmoid are often associated with hematochezia, tenesmus, and narrowing of the caliber of stool; anemia is an infrequent finding. Although these symptoms may lead patients and their physicians to suspect the presence of hemorrhoids, the development of rectal bleeding and/or altered bowel habits demands a prompt digital rectal examination and proctosigmoidoscopy.

### Staging, Prognostic Factors, and Patterns of Spread

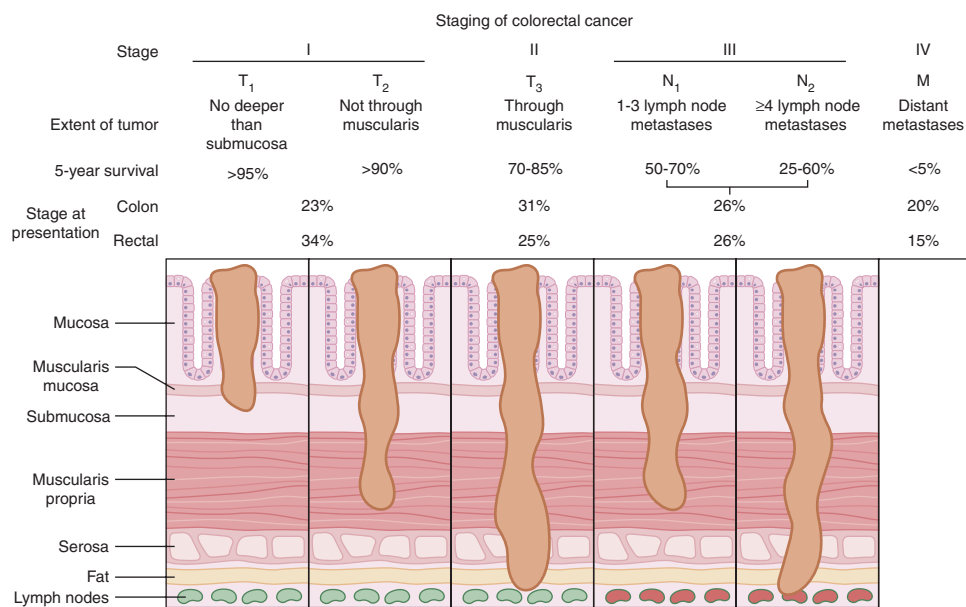
The prognosis for individuals having colorectal cancer is related to the depth of tumor penetration into the bowel wall and the presence of both regional lymph node involvement and distant metastases. These variables are incorporated into the staging system introduced by Dukes and applied to a TNM classification method, in



**FIGURE 35-1**  
Double-contrast air-barium enema revealing a sessile tumor of the cecum in a patient with iron-deficiency anemia and guaiac-positive stool. The lesion at surgery was a stage II adenocarcinoma.



**FIGURE 35-2**  
Annular, constricting adenocarcinoma of the descending colon. This radiographic appearance is referred to as an “apple-core” lesion and is always highly suggestive of malignancy.



**FIGURE 35-3**  
Staging and prognosis for patients with colorectal cancer.

which T represents the depth of tumor penetration, N the presence of lymph node involvement, and M the presence or absence of distant metastases (Fig. 35-3). Superficial lesions that do not involve regional lymph nodes and do not penetrate through the submucosa (T<sub>1</sub>) or the muscularis (T<sub>2</sub>) are designated as *stage I* (T<sub>1-2</sub>N<sub>0</sub>M<sub>0</sub>) disease; tumors that penetrate through the muscularis but have not spread to lymph nodes are *stage II* disease (T<sub>3</sub>N<sub>0</sub>M<sub>0</sub>); regional lymph node involvement defines *stage III* (T<sub>x</sub>N<sub>1</sub>M<sub>0</sub>) disease; and metastatic spread to sites such as liver, lung, or bone indicates *stage IV* (T<sub>x</sub>N<sub>x</sub>M<sub>1</sub>) disease. Unless gross evidence of metastatic disease is present, disease stage cannot be determined accurately before surgical resection and pathologic analysis of the operative specimens. It is not clear whether the detection of nodal metastases by special immunohistochemical molecular techniques has the same prognostic implications as disease detected by routine light microscopy.

Most recurrences after a surgical resection of a large-bowel cancer occur within the first 4 years, making 5-year survival a fairly reliable indicator of cure. The likelihood for 5-year survival in patients with colorectal cancer is stage-related (Fig. 35-3). That likelihood has improved during the past several decades when similar surgical stages have been compared. The most plausible explanation for this improvement is more thorough intraoperative and pathologic staging. In particular, more exacting attention to pathologic detail has revealed that the prognosis following the resection of a colorectal cancer is not related merely to the presence or absence of regional lymph node involvement. Prognosis may be more precisely gauged by the number of involved lymph nodes (one to three lymph nodes versus four or more lymph nodes). A minimum of 12 sampled lymph nodes is

thought necessary to define tumor stage accurately. Other predictors of a poor prognosis after a total surgical resection include tumor penetration through the bowel wall into pericolic fat, poorly differentiated histology, perforation and/or tumor adherence to adjacent organs (increasing the risk for an anatomically adjacent recurrence), and venous invasion by tumor (Table 35-6). Regardless of the clinicopathologic stage, a preoperative elevation of the plasma carcinoembryonic antigen (CEA) level predicts eventual tumor recurrence. The presence of aneuploidy and specific chromosomal deletions, such as allelic loss in chromosome 18q (involving the *DCC* gene) in tumor cells, appears to predict a higher risk for metastatic spread, particularly in patients with stage II (T<sub>3</sub>N<sub>0</sub>M<sub>0</sub>) disease. Conversely, the detection of microsatellite instability in tumor tissue indicates a more

**TABLE 35-6**

**PREDICTORS OF POOR OUTCOME FOLLOWING TOTAL SURGICAL RESECTION OF COLORECTAL CANCER**

- Tumor spread to regional lymph nodes
- Number of regional lymph nodes involved
- Tumor penetration through the bowel wall
- Poorly differentiated histology
- Perforation
- Tumor adherence to adjacent organs
- Venous invasion
- Preoperative elevation of CEA titer (>5.0 ng/mL)
- Aneuploidy
- Specific chromosomal deletion (e.g., allelic loss on chromosome 18q)

**Note:** CEA, carcinoembryonic antigen.

484 favorable outcome. In contrast to most other cancers, the prognosis in colorectal cancer is not influenced by the size of the primary lesion when adjusted for nodal involvement and histologic differentiation.

Cancers of the large bowel generally spread to regional lymph nodes or to the liver via the portal venous circulation. The liver represents the most frequent visceral site of metastasis; it is the initial site of distant spread in one-third of recurring colorectal cancers and is involved in more than two-thirds of such patients at the time of death. In general, colorectal cancer rarely spreads to the lungs, supraclavicular lymph nodes, bone, or brain without prior spread to the liver. A major exception to this rule occurs in patients having primary tumors in the distal rectum, from which tumor cells may spread through the paravertebral venous plexus, escaping the portal venous system and thereby reaching the lungs or supraclavicular lymph nodes without hepatic involvement. The median survival after the detection of distant metastases has ranged in the past from 6–9 months (hepatomegaly, abnormal liver chemistries) to 24–30 months (small liver nodule initially identified by elevated CEA level and subsequent CT scan), but effective systemic therapy is improving the prognosis.

### **Rx Treatment:** **COLORECTAL CANCER**

Total resection of tumor is the optimal treatment when a malignant lesion is detected in the large bowel. An evaluation for the presence of metastatic disease, including a thorough physical examination, chest radiograph, biochemical assessment of liver function, and measurement of the plasma CEA level, should be performed before surgery. When possible, a colonoscopy of the entire large bowel should be performed to identify synchronous neoplasms and/or polyps. The detection of metastases should not preclude surgery in patients with tumor-related symptoms such as gastrointestinal bleeding or obstruction, but it often prompts the use of a less radical operative procedure. At the time of laparotomy, the entire peritoneal cavity should be examined, with thorough inspection of the liver, pelvis, and hemidiaphragm and careful palpation of the full length of the large bowel. Following recovery from a complete resection, patients should be observed carefully for 5 years by semiannual physical examinations and yearly blood chemistry measurements. If a complete colonoscopy was not performed preoperatively, it should be carried out within the first several postoperative months. Some authorities favor measuring plasma CEA levels at 3-month intervals because of the sensitivity of this test as a marker for otherwise undetectable tumor recurrence. Subsequent endoscopic or radiographic surveillance of the large bowel, probably at triennial intervals,

is indicated because patients who have been cured of one colorectal cancer have a 3–5% probability of developing an additional bowel cancer during their lifetime and a >15% risk for the development of adenomatous polyps. Anastomotic (“suture-line”) recurrences are infrequent in colorectal cancer patients provided the surgical resection margins are adequate and free of tumor. The value of periodic CT scans of the abdomen, assessing for an early asymptomatic indication of tumor recurrence, is an area of uncertainty, with some experts recommending the test be performed annually for the first three postoperative years.

Radiation therapy to the pelvis is recommended for patients with rectal cancer because it reduces the 20–25% probability of regional recurrences following complete surgical resection of stage II or III tumors, especially if they have penetrated through the serosa. This alarmingly high rate of local disease recurrence is believed to be due to the fact that the contained anatomic space within the pelvis limits the extent of the resection and because the rich lymphatic network of the pelvic side wall immediately adjacent to the rectum facilitates the early spread of malignant cells into surgically inaccessible tissue. The use of sharp rather than blunt dissection of rectal cancers (*total mesorectal excision*) appears to reduce the likelihood of local disease recurrence to ~10%. Radiation therapy, either pre- or postoperatively, reduces the likelihood of pelvic recurrences but does not appear to prolong survival. Preoperative radiotherapy is indicated for patients with large, potentially unresectable rectal cancers; such lesions may shrink enough to permit subsequent surgical removal. Radiation therapy is not effective in the primary treatment of colon cancer.

Systemic therapy for patients with colorectal cancer has become more effective. 5-FU remains the backbone of treatment for this disease. Partial responses are obtained in 15–20% of patients. The probability of tumor response appears to be somewhat greater for patients with liver metastases when chemotherapy is infused directly into the hepatic artery, but intraarterial treatment is costly and toxic and does not appear to prolong survival appreciably. The concomitant administration of folinic acid (leucovorin) improves the efficacy of 5-FU in patients with advanced colorectal cancer, presumably by enhancing the binding of 5-FU to its target enzyme, thymidylate synthase. A threefold improvement in the partial response rate is noted when folinic acid is combined with 5-FU; however, the effect on survival is marginal, and the optimal dose schedule remains to be defined. 5-FU is generally administered intravenously but may also be given orally in the form of capecitabine with seemingly similar efficacy.

Irinotecan (CPT-11), a topoisomerase 1 inhibitor, prolongs survival when compared to supportive care in

patients whose disease has progressed on 5-FU. Furthermore, the addition of irinotecan to 5-FU and leucovorin (LV) improves response rates and survival of patients with metastatic disease. The *FOLFIRI regimen* is as follows: irinotecan, 180 mg/m<sup>2</sup> as a 90-min infusion day 1; LV, 400 mg/m<sup>2</sup> as a 2-h infusion during irinotecan, immediately followed by 5-FU bolus, 400 mg/m<sup>2</sup> and 46-h continuous infusion of 2.4–3 g/m<sup>2</sup> every 2 weeks. Diarrhea is the major side effect from irinotecan. Oxaliplatin, a platinum analogue, also improves the response rate when added to 5-FU and LV as initial treatment of patients with metastatic disease. The *FOLFOX regimen* is the following: 2-h infusion of LV (400 mg/m<sup>2</sup> per day) followed by a 5-FU bolus (400 mg/m<sup>2</sup> per day) and 22-h infusion (1200 mg/m<sup>2</sup>) every 2 weeks, together with oxaliplatin, 85 mg/m<sup>2</sup> as a 2-h infusion on day 1. Oxaliplatin frequently causes a dose-dependent sensory neuropathy that usually resolves following the cessation of therapy. FOLFIRI and FOLFOX are equal in efficacy.

Monoclonal antibodies are also effective in patients with advanced colorectal cancer. Cetuximab (Erbix) and panitumumab (Vectibix) are directed against the epidermal growth factor receptor (EGFR), a transmembrane glycoprotein involved in signaling pathways affecting growth and proliferation of tumor cells. Both cetuximab and panitumumab, when given alone, have been shown to benefit a small proportion of previously treated patients, and cetuximab appears to have therapeutic synergy with such chemotherapeutic agents as irinotecan, even in patients previously resistant to this drug; this suggests that cetuximab can reverse cellular resistance to cytotoxic chemotherapy. The use of both cetuximab and panitumumab can lead to an acne-like rash with the development and severity of the rash correlated with the likelihood of antitumor efficacy. Inhibitors of the EGFR tyrosine kinase such as erlotinib (Tarceva) do not appear to be effective in colorectal cancer.

Bevacizumab (Avastin) is a monoclonal antibody directed against the vascular endothelial growth factor (VEGF) and is thought to act as an anti-angiogenesis agent. The addition of bevacizumab to irinotecan-containing combinations and to FOLFOX improves the outcome observed with the chemotherapy alone. The use of bevacizumab can lead to hypertension, proteinuria, and an increased likelihood of thromboembolic events.

Patients with solitary hepatic metastases without clinical or radiographic evidence of additional tumor involvement should be considered for partial liver resection because such procedures are associated with 5-year survival rates of 25–30% when performed on selected individuals by experienced surgeons.

The administration of 5-FU and LV for 6 months after resection of tumor in patients with stage III disease leads to a 40% decrease in recurrence rates and 30%

improvement in survival. The likelihood of recurrence has been further reduced when oxaliplatin has been combined with 5-FU and LV (e.g. FOLFOX); unexpectedly, the addition of irinotecan to 5-FU and LV did not enhance outcome. Patients with stage II tumors do not appear to benefit from adjuvant therapy. In rectal cancer, the delivery of preoperative or postoperative combined modality therapy (5-FU plus radiation therapy) reduces the risk of recurrence and increases the chance of cure for patients with stages II and III tumors, with the preoperative approach being better tolerated. The 5-FU acts as a radiosensitizer when delivered together with radiation therapy. Life-extending adjuvant therapy is used in only about half of patients >65 years of age. This age bias is completely inappropriate because the benefits and tolerance of adjuvant therapy in patients age 65+ appear similar to those seen in younger individuals.

## TUMORS OF THE SMALL INTESTINE

Small-bowel tumors comprise <3% of gastrointestinal neoplasms. Because of their rarity, a correct diagnosis is often delayed. Abdominal symptoms are usually vague and poorly defined, and conventional radiographic studies of the upper and lower intestinal tract often appear normal. Small-bowel tumors should be considered in the differential diagnosis in the following situations: (1) recurrent, unexplained episodes of crampy abdominal pain; (2) intermittent bouts of intestinal obstruction, especially in the absence of IBD or prior abdominal surgery; (3) intussusception in the adult; and (4) evidence of chronic intestinal bleeding in the presence of negative conventional contrast radiographs. A careful small-bowel barium study is the diagnostic procedure of choice; the diagnostic accuracy may be improved by infusing barium through a nasogastric tube placed into the duodenum (enteroclysis).

## BENIGN TUMORS

The histology of benign small-bowel tumors is difficult to predict on clinical and radiologic grounds alone. The symptomatology of benign tumors is not distinctive, with pain, obstruction, and hemorrhage the most frequent symptoms. These tumors are usually discovered during the fifth and sixth decades of life, more often in the distal rather than the proximal small intestine. The most common benign tumors are adenomas, leiomyomas, lipomas, and angiomas.

### Adenomas

These tumors include those of the islet cells and Brunner's glands as well as polypoid adenomas. *Islet cell adenomas* are

486 occasionally located outside the pancreas; the associated syndromes are discussed in Chap. 46. *Brunner's gland adenomas* are not truly neoplastic but represent a hypertrophy or hyperplasia of submucosal duodenal glands. These appear as small nodules in the duodenal mucosa that secrete a highly viscous alkaline mucus. Most often, this is an incidental radiographic finding not associated with any specific clinical disorder.

### **Polypoid Adenomas**

About 25% of benign small-bowel tumors are polypoid adenomas (Table 35-5). They may present as single polypoid lesions or, less commonly, as papillary villous adenomas. As in the colon, the sessile or papillary form of the tumor is sometimes associated with a coexisting carcinoma. Occasionally, patients with Gardner's syndrome develop premalignant adenomas in the small bowel; such lesions are generally in the duodenum. Multiple polypoid tumors may occur throughout the small bowel (and occasionally the stomach and colorectum) in the Peutz-Jeghers syndrome. The polyps are usually hamartomas (juvenile polyps) having a low potential for malignant degeneration. Mucocutaneous melanin deposits as well as tumors of the ovary, breast, pancreas, and endometrium are also associated with this autosomal dominant condition.

### **Leiomyomas**

These neoplasms arise from smooth-muscle components of the intestine and are usually intramural, affecting the overlying mucosa. Ulceration of the mucosa may cause gastrointestinal hemorrhage of varying severity. Cramping or intermittent abdominal pain is frequently encountered.

### **Lipomas**

These tumors occur with greatest frequency in the distal ileum and at the ileocecal valve. They have a characteristic radiolucent appearance, are usually intramural and asymptomatic, but on occasion cause bleeding.

### **Angiomas**

Although not true neoplasms, these lesions are important because they frequently cause intestinal bleeding. They may take the form of telangiectasia or hemangiomas. Multiple intestinal telangiectasias occur in a nonhereditary form confined to the gastrointestinal tract or as part of the hereditary Osler-Rendu-Weber syndrome. Vascular tumors may also take the form of isolated hemangiomas, most commonly in the jejunum. Angiography, especially during bleeding, is the best procedure for evaluating these lesions.

## **MALIGNANT TUMORS**

Although rare, small-bowel malignancies occur in patients with long-standing regional enteritis and celiac sprue as well as in individuals with AIDS. Malignant tumors of the small bowel are frequently associated with fever, weight loss, anorexia, bleeding, and a palpable abdominal mass. After ampullary carcinomas (many of which arise from biliary or pancreatic ducts), the most frequently occurring small-bowel malignancies are adenocarcinomas, lymphomas, carcinoid tumors, and leiomyosarcomas.

### **Adenocarcinomas**

The most common primary cancers of the small bowel are adenocarcinomas, accounting for ~50% of malignant tumors. These cancers occur most often in the distal duodenum and proximal jejunum, where they tend to ulcerate and cause hemorrhage or obstruction. Radiologically, they may be confused with chronic duodenal ulcer disease or with Crohn's disease if the patient has long-standing regional enteritis. The diagnosis is best made by endoscopy and biopsy under direct vision. Surgical resection is the treatment of choice.

### **LYMPHOMAS**

Lymphoma in the small bowel may be primary or secondary. A diagnosis of a primary intestinal lymphoma requires histologic confirmation in a clinical setting in which palpable adenopathy and hepatosplenomegaly are absent and no evidence of lymphoma is seen on chest radiograph, CT scan, or peripheral blood smear or on bone marrow aspiration and biopsy. Symptoms referable to the small bowel are present, usually accompanied by an anatomically discernible lesion. Secondary lymphoma of the small bowel consists of involvement of the intestine by a lymphoid malignancy extending from involved retroperitoneal or mesenteric lymph nodes (Chap. 15).

Primary intestinal lymphoma accounts for ~20% of malignancies of the small bowel. These neoplasms are non-Hodgkin's lymphomas; they usually have a diffuse large-cell histology and are of T cell origin. Intestinal lymphoma involves the ileum, jejunum, and duodenum, in decreasing frequency, a pattern that mirrors the relative amount of normal lymphoid cells in these anatomic areas. The risk of small-bowel lymphoma is increased in patients with a prior history of malabsorptive conditions (e.g., celiac sprue), regional enteritis, and depressed immune function due to congenital immunodeficiency syndromes, prior organ transplantation, autoimmune disorders, or AIDS.

The development of localized or nodular masses that narrow the lumen results in periumbilical pain (made worse by eating) as well as weight loss, vomiting, and occasional intestinal obstruction. The diagnosis of small-bowel lymphoma may be suspected from the appearance on

contrast radiographs of patterns such as infiltration and thickening of mucosal folds, mucosal nodules, areas of irregular ulceration, or stasis of contrast material. The diagnosis can be confirmed by surgical exploration and resection of involved segments. Intestinal lymphoma can occasionally be diagnosed by peroral intestinal mucosal biopsy, but because the disease mainly involves the lamina propria, full-thickness surgical biopsies are usually required.

Resection of the tumor constitutes the initial treatment modality. Although postoperative radiation therapy has been given to some patients following a total resection, most authorities favor short-term (three cycles) systemic treatment with combination chemotherapy. The frequent presence of widespread intraabdominal disease at the time of diagnosis and the occasional multicentricity of the tumor often make a total resection impossible. The probability of sustained remission or cure is ~75% in patients with localized disease but is ~25% in individuals with unresectable lymphoma. In patients whose tumors are not resected, chemotherapy may lead to bowel perforation.

A unique form of small-bowel lymphoma, diffusely involving the entire intestine, was first described in Asian Jews and Arabs and is referred to as *immunoproliferative small intestinal disease (IPSID)*, *Mediterranean lymphoma*, or  *$\alpha$ -heavy chain disease*. This is a B cell tumor. The typical presentation includes chronic diarrhea and steatorrhea associated with vomiting and abdominal cramps; clubbing of the digits may be observed. A curious feature in many patients with IPSID is the presence in the blood and intestinal secretions of an abnormal IgA that contains a shortened  $\alpha$ -heavy chain and is devoid of light chains. It is suspected that the abnormal  $\alpha$  chains are produced by plasma cells infiltrating the small bowel. The clinical course of patients with IPSID is generally one of exacerbations and remissions, with death frequently resulting from either progressive malnutrition and wasting or the development of an aggressive lymphoma. The use of oral antibiotics such as tetracycline appears to be beneficial in the early phases of the disorder, suggesting a possible infectious etiology. Combination chemotherapy has been administered during later stages of the disease, with variable results. Results are better when antibiotics and chemotherapy are combined.

### Carcinoid Tumors

Carcinoid tumors arise from argentaffin cells of the crypts of Lieberkühn and are found from the distal duodenum to the ascending colon, areas embryologically derived from the midgut. More than 50% of intestinal carcinoids are found in the distal ileum, with most congregating close to the ileocecal valve. Most intestinal carcinoids are asymptomatic and of low malignant

potential, but invasion and metastases may occur, leading to the carcinoid syndrome (Chap. 46).

### Leiomyosarcomas

Leiomyosarcomas often are >5 cm in diameter and may be palpable on abdominal examination. Bleeding, obstruction, and perforation are common. Such tumors should be analyzed for the expression of mutant *c-kit* receptor (defining GIST), and in the presence of metastatic disease, justifying treatment with imatinib mesylate (Gleevec) or, in imatinib-refractory patients, sunitinib (Sutent).

## CANCERS OF THE ANUS

Cancers of the anus account for 1–2% of the malignant tumors of the large bowel. Most such lesions arise in the anal canal, the anatomic area extending from the anorectal ring to a zone approximately halfway between the pectinate (or dentate) line and the anal verge. Carcinomas arising proximal to the pectinate line (i.e., in the transitional zone between the glandular mucosa of the rectum and the squamous epithelium of the distal anus) are known as *basaloid*, *cuboidal*, or *cloacogenic* tumors; about a third of anal cancers have this histologic pattern. Malignancies arising distal to the pectinate line have squamous histology, ulcerate more frequently, and constitute ~55% of anal cancers. The prognosis for patients with basaloid and squamous cell cancers of the anus is identical when corrected for tumor size and the presence or absence of nodal spread.

The development of anal cancer is associated with infection by human papillomavirus, the same organism etiologically linked to cervical cancer. The virus is sexually transmitted. The infection may lead to anal warts (condyloma acuminata), which may progress to anal intraepithelial neoplasia and on to squamous cell carcinoma. The risk for anal cancer is increased among homosexual men, presumably related to anal intercourse. Anal cancer risk is increased in both men and women with AIDS, possibly because their immunosuppressed state permits more severe papillomavirus infection. Anal cancers occur most commonly in middle-aged persons and are more frequent in women than men. At diagnosis, patients may experience bleeding, pain, sensation of a perianal mass, and pruritus.

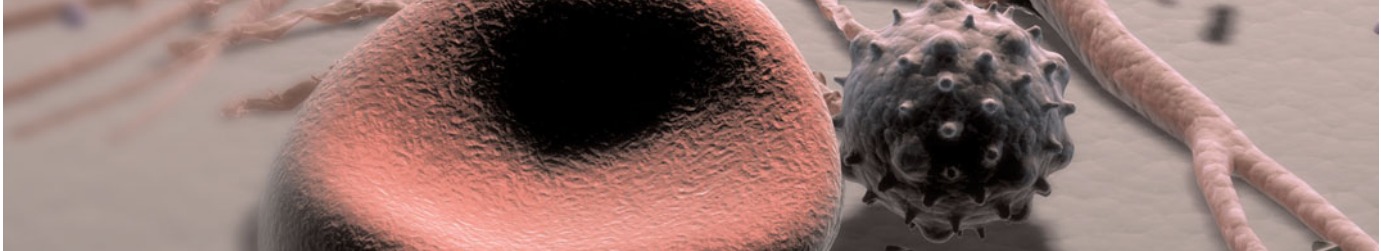
Radical surgery (abdominal-perineal resection with lymph node sampling and a permanent colostomy) was once the treatment of choice for this tumor type. The 5-year survival rate after such a procedure was 55–70% in the absence of spread to regional lymph nodes and <20% if nodal involvement was present. An alternative therapeutic approach combining external beam radiation therapy with concomitant chemotherapy has resulted in biopsy-proven disappearance of all tumor in



488 >80% of patients whose initial lesion was <3 cm in size. Tumor recurrences develop in <10% of these patients, meaning that ~70% of patients with anal cancers can be cured with nonoperative treatment. Surgery should be reserved for the minority of individuals who are found to have residual tumor after being managed initially with radiation therapy combined with chemotherapy.

### FURTHER READINGS

- BIRD-LIEBERMAN EL, FITZGERALD RC: Early diagnosis of oesophageal cancer. *Br J Cancer* 101:1, 2009
- CRUMP W et al: Lymphoma of the gastrointestinal tract. *Semin Oncol* 26:324, 1999
- DEMETRI GD et al: Efficacy and safety of imatinib mesylate in advanced gastrointestinal stromal tumors. *N Engl J Med* 347:472, 2002
- ENZINGER PC, MAYER RJ: Esophageal cancer. *N Engl J Med* 349:2241, 2003
- HOHENBERGER P, GRETSCHEL S: Gastric cancer. *Lancet* 362:305, 2003
- KOHNE CH, LENZ HJ: Chemotherapy with targeted agents for the treatment of metastatic colorectal cancer. *Oncologist* 14:478, 2009
- LYNCH HT, DE LA CHAPELLE A: Hereditary colorectal cancer. *N Engl J Med* 348:919, 2003
- MCCOURT M et al: Rectal cancer. *Surgeon* 7:162, 2009
- MEYERHARDT JA, MAYER RJ: Systemic therapy for colorectal cancer. *N Engl J Med* 352:476, 2005
- ROSTRUM A et al: Nonsteroidal anti-inflammatory drugs and cyclooxygenase-2 inhibitors for primary prevention of colorectal cancer: A systematic review prepared for the US Preventive Services Task Force. *Ann Intern Med* 146:376, 2007
- RYAN DP et al: Carcinoma of the anal canal. *N Engl J Med* 342:792, 2000
- SPECHLER SJ: Barrett's esophagus. *N Engl J Med* 346:836, 2002
- UEMURA N et al: *Helicobacter pylori* infection and the development of gastric cancer. *N Engl J Med* 345:784, 2001
- WAGNER AD, MOEHLER M: Development of targeted therapies in advanced gastric cancer: Promising exploratory steps in a new era. *Curr Opin Oncol* 21:381, 2009
- WALSH JME, TERDIMAN JP: Colorectal cancer screening. *JAMA* 289:1288, 2003
- WEITZ J et al: Colorectal cancer. *Lancet* 365:153, 2005
- WOLAN BM et al: Adjuvant treatment of colorectal cancer. *CA Cancer Clin J* 57:168, 2007



## CHAPTER 36


# TUMORS OF THE LIVER AND BILIARY TREE

Brian I. Carr

■ Hepatocellular Carcinoma . . . . .	.489	Fibrolamellar HCC (FL-HCC) . . . . .	.496
Incidence . . . . .	.489	Epithelioid Hemangioendothelioma (EHE) . . . . .	.497
Epidemiology . . . . .	.490	Cholangiocarcinoma (CCC) . . . . .	.497
Etiologic Factors . . . . .	.490	Gallbladder Cancer (GB CA) . . . . .	.497
Clinical Features . . . . .	.490	Carcinoma of the Ampulla of Vater . . . . .	.498
Staging . . . . .	.491	Tumors Metastatic to the Liver . . . . .	.498
Screening High-Risk Populations . . . . .	.493	Benign Liver Tumors . . . . .	.498
Summary . . . . .	.496	■ Further Readings . . . . .	.498
■ Other Primary Liver Tumors . . . . .	.496		

## HEPATOCELLULAR CARCINOMA

### INCIDENCE

 Hepatocellular carcinoma (HCC) is one of the most common malignancies worldwide. The annual global incidence is ~1 million cases, with a male-to-female ratio of ~4:1. The incidence rate equals the death rate. In the United States, 19,160 new cases and 16,780 deaths were noted in 2007. The death rate in males in low-incidence countries such as the United States is 1.9 per 100,000 per year; in intermediate-incidence areas such as Austria and South Africa, annual death rates range from 5.1–20.0 per 100,000; and in high-incidence areas such as in Asia (China and Korea), death rates are as high as 23.1–150 per 100,000 per year ([Table 36-1](#)). The incidence of HCC in the United States is ~3 per 100,000 persons, with significant sex, ethnic, and geographic variations. These numbers are rapidly increasing and may be an underestimate. Around 4 million persons in the United States are chronic carriers of hepatitis C virus (HCV). About 10% of them, or 400,000, are likely to develop cirrhosis. Around 5% or 20,000 of these may develop HCC annually. Add to this the two other common predisposing factors—hepatitis B virus (HBV) and chronic alcohol consumption—and 60,000 new HCC


**TABLE 36-1**

### AGE-ADJUSTED INCIDENCE RATES FOR HEPATOCELLULAR CARCINOMA

COUNTRY	PERSONS PER 100,000 PER YEAR	
	MALE	FEMALE
Argentina	6.0	2.5
Brazil, Recife	9.2	8.3
Brazil, São Paulo	3.8	2.6
Mozambique	112.9	30.8
South Africa, Cape: Black	26.3	8.4
South Africa, Cape: White	1.2	0.6
Senegal	25.6	9.0
Nigeria	15.4	3.2
Gambia	33.1	12.6
Burma	25.5	8.8
Japan	7.2	2.2
Korea	13.8	3.2
China, Shanghai	34.4	11.6
India, Bombay	4.9	2.5
India, Madras	2.1	0.7
Great Britain	1.6	0.8
France	6.9	1.2
Italy, Varese	7.1	2.7
Norway	1.8	1.1
Spain, Navarra	7.9	4.7


490 cases annually seem possible. Future advances in HCC survival will likely depend on immunization strategies for HBV and HCV and earlier diagnosis by screening of patients at risk of HCC development.

## EPIDEMIOLOGY

 Endemic hot spots occur in areas of China and sub-Saharan Africa, which are associated with both high endemic hepatitis B carrier rates and mycotoxin contamination of foodstuffs, stored grains, drinking water, and soil. Environmental factors are important; Japanese in Japan have a higher incidence than those living in Hawaii, who in turn have a higher incidence than those living in California.

## ETIOLOGIC FACTORS

### Chemical Carcinogens

 Probably the best studied and most potent ubiquitous natural chemical carcinogen is a product of the *Aspergillus* fungus, called aflatoxin B<sub>1</sub>. This mold and aflatoxin product can be found in stored grains in hot, humid places, where peanuts and rice are stored in unrefrigerated conditions. Aflatoxin contamination of foodstuffs correlates well with incidence rates in Africa and to some extent in China. In endemic areas of China, even farm animals such as ducks have HCC. The most potent carcinogens appear to be natural products of plants, fungi, and bacteria, such as bush trees containing pyrrolizidine alkaloids as well as tannic acid and safrole. Pollutants such as pesticides and insecticides are known rodent carcinogens.

### Hepatitis


 Both case-control and cohort studies have shown a strong association between chronic hepatitis B carrier rates and increased incidence of HCC. In Taiwanese male postal carriers who were hepatitis B surface antigen (HBsAg)-positive, a 98-fold greater risk for HCC was found compared to HBsAg-negative individuals. The incidence of HCC in Alaskan natives is markedly increased related to a high prevalence of HBV infection. HBV-based HCC may arise from rounds of hepatic destruction with subsequent proliferation and not necessarily from frank cirrhosis. The increase in Japanese HCC incidence rates in the past three decades is thought to be from hepatitis C. A large-scale intervention study sponsored by the World Health Organization (WHO) is currently underway in Asia involving HBV vaccination of the newborn. HCC in African blacks is not associated with severe cirrhosis but is poorly differentiated and very aggressive. Despite uniform HBV carrier rates among the South African Bantu, there is a ninefold difference in HCC incidence


TABLE 36-2

## RISK FACTORS FOR HEPATOCELLULAR CARCINOMA

COMMON	UNUSUAL
Cirrhosis from any cause	Primary biliary cirrhosis
Hepatitis B or C chronic infection	Hemochromatosis
Ethanol chronic consumption	$\alpha_1$ Antitrypsin deficiency
Nonalcoholic steatohepatitis (NASH)	Glycogen storage diseases
Aflatoxin B <sub>1</sub> or other mycotoxins	Citrullinemia
	Porphyria cutanea tarda
	Hereditary tyrosinemia
	Wilson's disease

between Mozambicans living along the coast and inland. These differences are attributed to the additional exposure to dietary aflatoxin B<sub>1</sub> and other carcinogenic mycotoxins. A typical interval between HCV-associated transfusion and subsequent HCC is ~30 years. HCV-associated HCC patients tend to have more frequent and advanced cirrhosis, but in HBV-associated HCC, only half the patients have cirrhosis; the remainder have chronic active hepatitis.

### Other Etiologic Conditions

 The 75–85% association of HCC with underlying cirrhosis has long been recognized, more typically with macronodular cirrhosis in Southeast Asia but also with micronodular cirrhosis (alcohol) in Europe and the United States. It is still not clear whether cirrhosis itself is a predisposing factor to the development of HCC or whether the underlying causes of the cirrhosis are actually the carcinogenic factors. However, ~20 % of U.S. patients with HCC do not have underlying cirrhosis. Several underlying conditions are associated with an increased risk for cirrhosis-associated HCC (Table 36-2), including hepatitis, alcohol abuse, autoimmune chronic active hepatitis, cryptogenic cirrhosis, and nonalcoholic steatohepatitis (NASH). A less common association is with primary biliary cirrhosis and several metabolic diseases, including hemochromatosis, Wilson's disease,  $\alpha_1$ -antitrypsin deficiency, tyrosinemia, porphyria cutanea tarda, glycogenesis types 1 and 3, citrullinemia, and orotic aciduria. The etiology of HCC in those 20% of patients who have no cirrhosis is unclear, and their HCC natural history not well-defined.

## CLINICAL FEATURES


 Symptoms in HCC patients include abdominal pain, weight loss, weakness, abdominal fullness and swelling, jaundice, and nausea (Table 36-3). Presenting signs and symptoms differ somewhat between high- and

TABLE 36-3

**HEPATOCELLULAR CARCINOMA: CLINICAL PRESENTATION AT THE UNIVERSITY OF PITTSBURGH LIVER CANCER CENTER (N = 547)**

Symptom	NUMBER OF PATIENTS (%)
No symptom	129 (24)
Abdominal pain	219 (40)
Other (workup of anemia and various diseases)	64 (12)
Routine physical examination finding, elevated LFTs	129 (24)
Weight loss	112 (20)
Appetite loss	59 (11)
Weakness/malaise	83 (15)
Jaundice	30 (5)
Routine CT scan screening of known cirrhosis	92 (17)
Cirrhosis symptoms (ankle swelling, abdominal bloating, increased girth, pruritus, GI bleed)	98 (18)
Diarrhea	7 (1)
Tumor rupture	1
<b>Patient characteristics</b>	
Mean age (years)	56 ± 13
Male: Female	3:1
Ethnicity	
White	72%
Middle Eastern	10%
Asian	13%
African American	5%
Cirrhosis	81%
No cirrhosis	19%
<b>Tumor characteristics</b>	
Hepatic tumor numbers	
1	20%
2	25%
3 or more	65%
Portal vein invasion	75%
Unilobar	25%
Bilobar	75%

**Note:** LFTs, liver function tests; GI, gastrointestinal.

low-incidence areas. The most common symptom is abdominal pain in high-risk areas, especially in South African blacks; by contrast, only 40–50% of Chinese and Japanese patients present with abdominal pain. Abdominal swelling may occur as a consequence of ascites due to the underlying chronic liver disease or may be due to a rapidly expanding tumor. Occasionally, central necrosis or acute hemorrhage into the peritoneal cavity leads to death. In countries with an active surveillance program, HCC tends to be identified at an earlier stage when symptoms may be due only to the underlying disease. Jaundice is usually due to obstruction of the intrahepatic ducts by the underlying liver disease. Hematemesis may occur due to esophageal varices from the underlying

portal hypertension. Bone pain is seen in 3–12% of patients, but necropsies show bone metastases in ~20% of patients. Patients may be asymptomatic.

### Physical Signs

Hepatomegaly is the most common physical sign, occurring in 50–90% of patients. Abdominal bruits are noted in 6–25%, and ascites occurs in 30–60% of patients. Ascites should be examined by cytology. Splenomegaly is mainly due to portal hypertension. Weight loss and muscle wasting are common, particularly with rapidly growing or large tumors. Fever is found in 10–50% of patients, from unclear cause. The signs of chronic liver disease may be present, including jaundice, dilated abdominal veins, palmar erythema, gynecomastia, testicular atrophy, and peripheral edema. Budd-Chiari syndrome can occur due to HCC invasion of the hepatic veins; it should be suspected in patients with tense ascites and a large tender liver.

### Paraneoplastic Syndromes

Most paraneoplastic syndromes in HCC are biochemical abnormalities without associated clinical consequences. They include hypoglycemia (also caused by end-stage liver failure), erythrocytosis, hypercalcemia, hypercholesterolemia, dysfibrinogenemia, carcinoid syndrome, increased thyroxin-binding globulin, changes in secondary sex characteristics (gynecomastia, testicular atrophy, and precocious puberty), and porphyria cutanea tarda. Mild hypoglycemia occurs in rapidly growing HCC as part of terminal illness, and profound hypoglycemia may occur, although the cause is unclear. Erythrocytosis occurs in 3–12% of patients, and hypercholesterolemia in 10–40%. A high percentage of patients have thrombocytopenia or leukopenia not caused by cancer infiltration of bone marrow, as in other tumor types.

### STAGING

Although the TNM (primary tumor, regional nodes, metastasis) staging system set up by the American Joint Commission for Cancers (AJCC) is sometimes used, the newer Cancer of the Liver Italian Program (CLIP) system is now popular because it takes cirrhosis into account, as does the Okuda system (Table 36-4). Other staging systems have been proposed and a consensus is needed. The best prognosis is stage I, solitary tumor <2 cm in diameter without vascular invasion. Adverse prognostic features include ascites, vascular invasion, and lymph node spread. Vascular invasion, in particular, has profound effects on prognosis and may be microscopic or macroscopic (visible on CT). Most large tumors have microscopic vascular invasion, so full staging can usually be made only after surgical resection. Stage III disease

**CLIP AND OKUDA STAGING SYSTEMS FOR HEPATOCELLULAR CARCINOMA**
**CLIP CLASSIFICATION**

Variables	Points		
	0	1	2
i. Tumor number	Single	Multiple	—
Hepatic replacement by tumor (%) <sup>a</sup>	<50	<50	>50
ii. Child-Pugh score	A	B	C
iii. $\alpha$ -Fetoprotein level (ng/mL)	<400	$\geq$ 400	—
iv. Portal vein thrombosis (CT)	No	Yes	—

CLIP stages (score = sum of points): CLIP 0, 0 points; CLIP 1, 1 point; CLIP 2, 2 points; CLIP 3, 3 points.

**OKUDA CLASSIFICATION**

Tumor Size <sup>a</sup>		Ascites		Albumin (g/L)		Bilirubin (mg/dL)	
$\geq$ 50% (+)	<50% (-)	+	-	$\leq$ 3 (+)	>3 (-)	$\geq$ 3 (+)	<3 (-)
Okuda stages: stage 1, all (-); stage 2, 1 or 2 (+); stage 3, 3 or 4 (+).							

<sup>a</sup>Extent of liver occupied by tumor.

**Note:** CLIP, Cancer of the Liver Italian Program.

contains a mixture of lymph node–positive and –negative tumors. Stage III patients with positive lymph node disease have a poor prognosis, and few patients survive 1 year. The prognosis of stage IV is poor after either resection or transplantation, and 1-year survival is rare. A working staging system based entirely on clinical grounds that incorporates the contribution of the underlying liver disease was originally developed by Okuda et al. (Table 36-4). Patients with Okuda stage III have a dire prognosis because they usually cannot be curatively resected and the condition of their liver typically precludes chemotherapy.

**Approach to the Patient: HEPATOCELLULAR CARCINOMA**

**HISTORY AND PHYSICAL** The history is important in evaluating putative predisposing factors, including a history of hepatitis or jaundice, blood transfusion, or use of intravenous drugs. A family history of HCC or hepatitis should be sought, and a detailed social history taken to include job descriptions for industrial exposure to possible carcinogenic drugs as well as contraceptive hormones. Physical examination should include assessing stigmata of underlying liver disease such as jaundice, ascites, peripheral edema, spider nevi, palmar erythema, and weight loss. Evaluation of the abdomen for hepatic size, masses or ascites,

hepatic nodularity and tenderness, and splenomegaly is needed, as is assessment of overall clinical performance status and psychosocial evaluation.

**Serologic Assays**  $\alpha$ -Fetoprotein (AFP) is a serum tumor marker in HCC; however, it is only increased in about half of U.S. patients. The other widely used assay is that for des- $\gamma$ -carboxy prothrombin (DCP), a protein induced by vitamin K absence (PIVKA-2). This protein is increased in as many as 80% of HCC patients but may also be elevated in patients with vitamin K deficiency; it is always elevated after use of warfarin. It may predict for portal vein invasion. In a patient presenting with either a new hepatic mass or other indications of recent hepatic decompensation, carcinoembryonic antigen (CEA), vitamin B12, AFP, ferritin, PIVKA-2, and antimitochondrial Ab should be measured, and standard liver function tests should be performed, including prothrombin time (PT), partial thromboplastin time (PTT), albumin, transaminases,  $\gamma$ -glutamyl transpeptidase, and alkaline phosphatase. Decreases in platelet count and white blood cell count may reflect portal hypertension and associated hypersplenism. Hepatitis A, B, and C serology should be measured. If HBV or HCV serology is positive, quantitative measurements of HBV DNA or HCV RNA are needed.

**Radiology** An ultrasound examination of the liver is an excellent screening tool. The two characteristic vascular abnormalities are hypervascularity of the tumor mass (neovascularization or abnormal tumor–feeding arterial vessels) and thrombosis by tumor invasion of otherwise normal portal veins. To determine tumor size and extent and the presence of portal vein invasion accurately, a helical/triphasic CT scan of the abdomen and pelvis with fast contrast bolus technique should be performed to detect the vascular lesions typical of HCC. Portal vein invasion is normally detected as an obstruction and expansion of the vessel. A chest CT is used to exclude metastases. MRI can also provide detailed information, especially with the newer contrast agents. Ethiodol (Lipiodol) is an ethiodized oil emulsion retained by liver tumors that can be delivered by hepatic artery injection (5–15 mL) for CT imaging 1 week later. For small tumors, Ethiodol injection is very helpful before biopsy because its histologic presence constitutes proof that the needle biopsied the mass under suspicion. A prospective comparison of triphasic CT, gadolinium-enhanced MRI, ultrasound, and fluorodeoxyglucose positron emission tomography (FDG-PET) scans demonstrated similar results for CT, MRI, and ultrasound; PET imaging was unsuccessful.

**Pathologic Diagnosis** Histologic proof of the presence of HCC is obtained through a core liver biopsy of

the mass under ultrasound guidance as well as random biopsy of the underlying liver. Bleeding risk is increased compared to other cancers because (1) the tumors are hypervascular, and (2) patients often have thrombocytopenia and decreased clotting factors. Bleeding risk is further increased in the presence of ascites. Tracking of tumor has been an uncommon problem. Fine-needle aspirates may provide sufficient material for diagnosis of cancer, but core biopsies are preferred. Tissue architecture must be examined to distinguish between HCC and metastatic adenocarcinoma; laparoscopic approaches can also be used. For patients suspected of having portal vein involvement, a core biopsy of the portal vein may be performed safely. If positive, this is regarded as an exclusion criterion for transplantation for HCC.

### SCREENING HIGH-RISK POPULATIONS

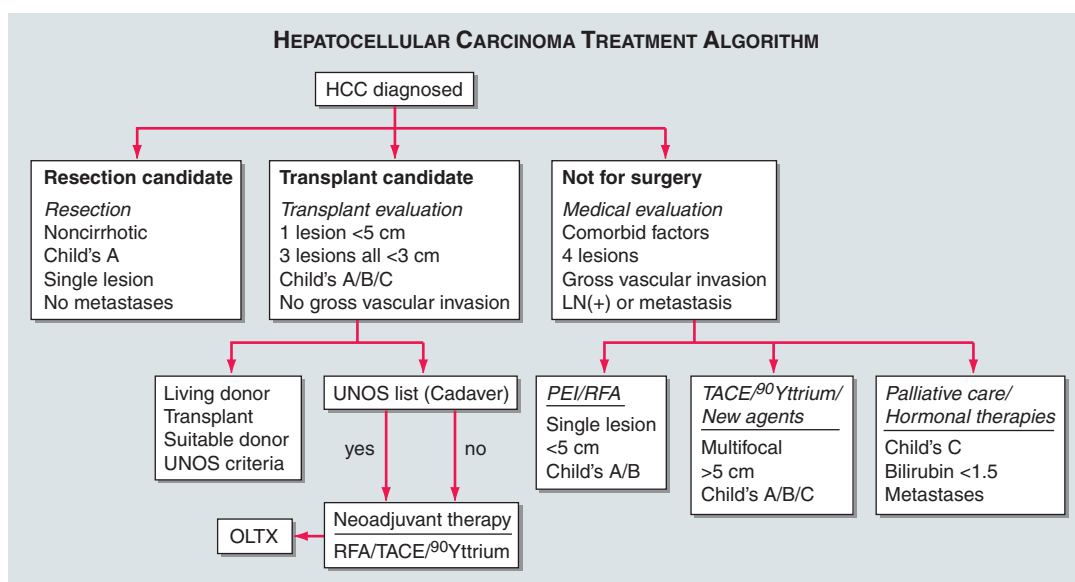


Screening has not been shown to save lives. Prospective studies in high-risk populations showed that ultrasound was more sensitive than AFP elevations. An Italian study in patients with cirrhosis identified a yearly HCC incidence of 3% but showed no increase in the rate of detection of potentially curable tumors with aggressive screening. Prevention strategies including universal vaccination against hepatitis viruses

are more likely to be effective than screening efforts. Despite absence of formal guidelines, most practitioners obtain 6-monthly AFP levels and perform CT (or ultrasound) when following high-risk patients (HBV carriers, HCV cirrhosis, family history of HCC).

### Rx Treatment: HEPATOCELLULAR CARCINOMA

Most HCC patients have two liver diseases, cirrhosis and HCC, each of which is an independent cause of death. The presence of cirrhosis usually places constraints on resection surgery, ablative therapies, and chemotherapy. Thus patient assessment and treatment planning have to take the severity of the nonmalignant liver disease into account. The clinical management choices for HCC can be complex (Fig. 36-1). The natural history of HCC is highly variable. Patients presenting with advanced tumors (vascular invasion, symptoms, extrahepatic spread) have a median survival of ~4 months, with or without treatment. Treatment results from the literature are difficult to interpret. Survival is not always a measure of the efficacy of therapy because of the adverse effects on survival of the underlying liver disease. A multidisciplinary team, including a hepatologist, interventional radiologist, surgical oncologist, transplant surgeon, and medical oncologist, is important for the comprehensive management of HCC patients.



**FIGURE 36-1**

**Treatment approach to patients with hepatocellular carcinoma.** The initial clinical evaluation is aimed at assessing the extent of the tumor and the underlying functional compromise of the liver by cirrhosis. Patients are classified as having resectable disease, unresectable disease, or as transplantation

candidates. OLTX, orthotopic liver transplantation; TACE, transarterial chemoembolization; PEI, percutaneous ethanol injection; RFA, radiofrequency ablation; LN, lymph node. Child's A/B/C refers to the Child-Pugh classification of liver failure.

**STAGES I AND II HCC** Early-stage tumors are successfully treated using various techniques, including surgical resection, local ablation (thermal or radiofrequency), and local injection therapies (ethanol or acetic acid). Because most patients with HCC suffer from a field defect in the cirrhotic liver, they are at risk for subsequent multiple primary liver tumors. Many will also have significant underlying liver disease and may not tolerate major surgical loss of hepatic parenchyma; they may be eligible for orthotopic liver transplant (OLT) in the future. An important principle in treating early-stage HCC is to use liver-sparing treatments and to focus on treatment of both the tumor and the cirrhosis.

**Surgical Excision** The risk of major hepatectomy is high (5–10% mortality) due to the underlying liver disease and the potential for liver failure. Preoperative portal vein occlusion can sometimes be performed to cause atrophy of the HCC-involved lobe and compensatory hypertrophy of the noninvolved liver, permitting safer resection. Intraoperative ultrasound is useful for planning the surgical approach. In cirrhotic patients, any major liver surgery can result in liver failure. The Child-Pugh classification of liver failure is a reliable prognosticator for tolerance of hepatic surgery, and only Child A patients should be considered for surgical resection. Child B and C patients with stages I and II HCC should be referred for OLT if appropriate, as should patients with ascites or a recent history of variceal bleeding. Although open surgical excision is the most reliable, the patient may be better served with a laparoscopic approach to resection, using RFA or percutaneous ethanol injection (PEI). No adequate comparisons of these different techniques have been undertaken, and the choice of treatment is usually based on physician skill.

**Local Ablation Strategies** Radiofrequency ablation (RFA) uses heat to ablate tumors. The maximum size of the probe arrays allows for a 7-cm zone of necrosis, which would be adequate for a 3- to 4-cm tumor. The heat reliably kills cells within the zone of necrosis. Treatment of tumors close to the main portal pedicles can lead to bile duct injury and obstruction. This limits the tumors that are anatomically suited for this technique. RFA can be performed percutaneously with CT or ultrasound guidance, or by laparoscopy with ultrasound guidance.

**Local Injection Therapy** Numerous agents have been used for local injection into tumors, most commonly, ethanol (PEI). The relatively soft HCC within the hard background of cirrhotic liver allows for injection of large volumes of ethanol into the tumor without diffusion into the hepatic parenchyma or leakage out of the liver. PEI causes direct destruction of cancer cells, but it is not selective for cancer cells and will destroy normal

cells in the vicinity. It usually requires multiple injections (average of three), in contrast to one for RFA. The maximum size of tumor reliably treated is 3 cm, even with multiple injections.

**Liver Transplantation** A viable option for stages I and II tumors in the setting of cirrhosis is OLT, with survival approaching that for noncancer cases. OLT for patients with a single lesion  $\leq 5$  cm or three or fewer nodules, each  $\leq 3$  cm (Milan criteria), resulted in excellent tumor-free survival ( $\geq 70\%$  at 5 years). For advanced HCC, OLT has been abandoned due to high tumor recurrence rates. Priority scoring for OLT previously led to HCC patients waiting too long for their OLT, resulting in some tumors becoming too advanced during the patient's wait for a donated liver. A variety of therapies were used as a "bridge" to OLT, including RFA, PEI, and transarterial chemoembolization (TACE). These pretransplant treatments allow patients to remain on the waiting list longer, giving them greater opportunities to be transplanted. What remains unclear is whether this translates into prolonged survival after transplant. Further, it is not known whether patients who have had their tumor(s) treated preoperatively follow the recurrence pattern predicted by their tumor status at the time of transplant (i.e., post local ablative therapy), or if they follow the course set by their tumor parameters present before such treatment. The United Network for Organ Sharing (UNOS) point system for priority scoring of OLT recipients now includes additional points for patients with HCC. The success of living related donor liver transplantation programs has also led to patients receiving transplantation earlier for HCC and often with greater than minimal tumors.

**Adjuvant Therapy** The role of adjuvant chemotherapy for patients after resection or OLT remains unclear. No clear advantage in disease-free or overall survival has been found for either adjuvant or neoadjuvant approaches, although a meta-analysis of several trials revealed a significant improvement in disease-free and overall survival. Analysis of postoperative adjuvant systemic chemotherapy trials demonstrated no disease-free or overall survival advantage, but single studies of TACE and neoadjuvant  $^{131}\text{I}$ -ethiodol have shown enhanced survival after resection.

**STAGES III AND IV HCC** Fewer surgical options exist for stage III tumors. In patients without cirrhosis, a major hepatectomy is feasible, although prognosis is poor. Patients with Child's A cirrhosis may be resected, but a lobectomy is associated with significant morbidity and mortality, and long-term prognosis is poor. Nevertheless, a small percentage of patients achieve long-term survival, justifying an attempt at resection when feasible. Because of the advanced nature of these tumors, even

successful resection can be followed by rapid recurrence. These patients are not considered candidates for transplantation because of the high tumor recurrence rates, unless their tumors can first be down-staged with neoadjuvant therapy. Decreasing the size of the primary tumor allows for less surgery, and the delay in surgery allows for extrahepatic disease to manifest on imaging studies and avoid unhelpful OLTX. The prognosis is poor for stage IV tumors, and no surgical treatment is recommended.

**Systemic Chemotherapy** A large number of controlled and uncontrolled clinical studies have been performed with most of the major classes of cancer chemotherapy. No single agent or combination of agents given systemically reproducibly leads to even a 25% response rate or has any effect on survival.

**Regional Chemotherapy** In contrast to the dismal results of systemic chemotherapy, a variety of agents given via the hepatic artery have activity in HCC confined to the liver (Table 36-5). Two randomized controlled trials have shown a survival advantage for TACE in a selected subset of patients. One used doxorubicin and the other used cisplatin. Despite the fact that increased hepatic extraction of chemotherapy has been shown for very few drugs, some drugs such as cisplatin, doxorubicin, mitomycin C, and possibly neocarzinostatin produce substantial objective responses when administered regionally. Few data are available on continuous hepatic arterial infusion for HCC, although pilot studies with cisplatin have shown encouraging responses. Because the reports have not usually stratified responses or survival based on TNM staging, it is difficult to know long-term prognosis in relation to tumor

extent. Most of the studies on regional hepatic arterial chemotherapy also use an embolizing agent such as Ethiodol, gelatin sponge particles (Gelfoam), starch (Spherex), or microspheres. Two products are composed of microspheres of defined size ranges—Embospheres (Biospheres) and Contour SE—using particles of 40–120, 100–300, 300–500, and 500–1000  $\mu\text{m}$  in size. The optimal diameter of the particles for TACE has yet to be defined. Consistently higher objective response rates appear to be reported for arterial administration of drugs together with some form of hepatic artery occlusion compared with any form of systemic chemotherapy to date. The widespread use of some form of embolization in addition to chemotherapy has added to its toxicities. These include a frequent but transient fever, abdominal pain, and anorexia (all in >60% of patients). In addition, >20% of patients have increased ascites or transient elevation of transaminases. Cystic artery spasm and cholecystitis are also not uncommon. However, higher responses have also been obtained. The hepatic toxicities associated with embolization may be ameliorated by the use of degradable starch microspheres, with 50–60% response rates. A major problem in showing a survival advantage in patients responding to TACE is that many patients die of their underlying cirrhosis, not the tumor. However, improving patient quality of life is a legitimate goal of regional therapies.

**Experimental Therapies** Several therapies are being evaluated (Table 36-6). Epidermal growth factor (EGF) receptor antibodies and EGF receptor kinase inhibitors are in clinical trials, as are various anti-angiogenesis therapies. No effects on survival are yet reported. Oral sorafenib increases median survival from

TABLE 36-5

**SOME RANDOMIZED CLINICAL TRIALS INVOLVING TRANSHEPATIC ARTERY CHEMOEMBOLIZATION (TACE) FOR HEPATOCELLULAR CARCINOMA**

AUTHOR	YEAR	AGENTS 1	AGENTS 2	SURVIVAL EFFECT
Kawai	1992	Doxorubicin + embo	Embo	No
Chang	1994	Cisplatin + embo	Embo	No
Hatanaka	1995	Cisplatin, doxorubicin + embo	Same + Ethiodol	No
Uchino	1993	Cisplatin, doxorubicin + oral FU	Same + tamoxifen	No
Lin	1988	Embo	Embo + IV FU	No
Yoshikawa	1994	Epirubicin + ethiodol (Lipiodol)	Epirubicin	No
Pelletier	1990	Doxorubicin + Gelfoam	None	No
Trinchet	1995	Cisplatin + Gelfoam	None	No
Bruix	1998	Coils and Gelfoam	None	No
Pelletier	1998	Cisplatin + Ethiodol	None	No
Trinchet	1995	Cisplatin + Gelfoam	None	No
Pelletier	1998	Cisplatin + Ethiodol	None	No
Lo	2002	Cisplatin + Ethiodol	None	Yes
Llovet	2002	Doxorubicin + Ethiodol	None	Yes

**Note:** embo, embolization; FU, fluorouracil.



### SOME NOVEL MEDICAL TREATMENTS FOR HEPATOCELLULAR CARCINOMA

EGF receptor antibody
Erlotinib, Gefitinib
Kinase antagonists, Sorafenib
Vitamin K
IL-2
<sup>131</sup> I – Ethiodol (Lipiodol)
<sup>131</sup> I – Ferritin
<sup>90</sup> Yttrium microspheres
<sup>166</sup> Holmium
Three-dimensional conformal radiation
Proton beam high-dose radiotherapy
Anti-angiogenesis strategies, Bevacizumab

**Note:** EGF, epidermal growth factor; IL, interleukin.

6 to 9 months in advanced, unresectable HCC. Several forms of *radiation therapy* have been used in the treatment of HCC, including external beam and conformal radiation therapy. Radiation hepatitis remains a significant dose-limiting problem. The pure beta emitter <sup>90</sup>yttrium attached to either glass or resin microspheres has been assessed in phase II trials of HCC and has encouraging survival effects with minimal toxicities. Randomized trials have yet to be performed. Vitamin K has been assessed in clinical trials at high dosage for its HCC-inhibitory actions. This idea is based on the characteristic biochemical defect in HCC of elevated plasma levels of immature prothrombin (DCP or PIVKA-2), due to a defect in the activity of prothrombin carboxylase, a vitamin K-dependent enzyme. Two vitamin K randomized controlled trials from Japan show decreased tumor occurrence. Patient participation in clinical trials aimed at assessing new therapies is encouraged.

## SUMMARY

### Most Common Modes of Patient Presentation

1. A patient with known history of hepatitis, jaundice, or cirrhosis, with an abnormality on ultrasound or CT scan, or rising AFP or DCP (PIVKA-2)
2. A patient with an abnormal liver function test as part of a routine examination
3. Radiologic workup for liver transplant for cirrhosis
4. Symptoms of HCC including cachexia, abdominal pain, or fever

### History and Physical Examination

1. Clinical jaundice, asthenia, itching (scratches), tremors, or disorientation
2. Hepatomegaly, splenomegaly, ascites, peripheral edema, skin signs of liver failure

## Clinical Evaluation

1. Blood tests: full blood count (splenomegaly), liver function tests, ammonia levels, electrolytes,  $\alpha$ -fetoprotein and DCP (PIVKA-2),  $\text{Ca}^{2+}$  and  $\text{Mg}^{2+}$ ; hepatitis B and C serology (and quantitative HBV DNA or HCV RNA, if either is positive); neurotensin (specific for fibrolamellar HCC)
2. Triphasic dynamic helical (spiral) CT scan of liver (if inadequate, then follow with an MRI); chest CT scan; upper and lower gastrointestinal endoscopy (for varices, bleeding, ulcers); and brain scan (only if symptoms suggest)
3. A core biopsy: of the tumor and separately of the underlying liver

## Therapy

(See also Fig. 36-1)

1. HCC <2 cm: RFA ablation, PEI, or resection
2. HCC >2 cm, no vascular invasion: liver resection, RFA, or OLTX
3. Multiple unilobar tumors or tumor with vascular invasion: TACE
4. Bilobar tumors, no vascular invasion: TACE with OLTX for patients whose tumors have a response
5. Extrahepatic HCC or elevated bilirubin: Phase I and II studies

## OTHER PRIMARY LIVER TUMORS

### FIBROLAMELLAR HCC (FL-HCC)

This rarer variant of HCC has a different biology than adult-type HCC. None of the known HCC causative factors seem important here. It is typically a disease of younger adults, often teenagers and predominantly females. It is AFP negative, but patients typically have elevated blood neurotensin levels, normal liver function tests, and no cirrhosis. Radiology is similar for HCC, except that characteristic adult-type portal vein invasion is less common. Although it is often multifocal in the liver, and therefore not resectable, metastases are common, especially to lungs and locoregional lymph nodes, but survival is often much better than with adult-type HCC. Resectable tumors are associated with 5-year survival of  $\geq 50\%$ . Patients often present with a huge liver or unexplained weight loss, fever, or elevated liver function tests on routine evaluations. These huge masses suggest slow growth. Surgical resection is the best management option, even for metastases, because these tumors respond much less well to chemotherapy than adult-type HCC. Although several series of OLTX for FL-HCC have been reported, the patients usually die from tumor recurrences, with a 2- to 5-year lag compared with OLTX for adult-type HCC. Anecdotal responses to gemcitabine plus cisplatin-TACE are reported.

the biliary drainage flowing into an external bag. Central tumors often invade the porta hepatis, and locoregional lymph node involvement by tumor is frequent.

### **Rx Treatment:** **CHOLANGIOCARCINOMA**

Hilar CCC is resectable in ~30% of patients and usually involves bile duct resection and lymphadenectomy. Typical survival is ~24 months, with recurrences mainly in the operative bed but with ~30% in the lungs and liver. Distal CCC, which involves the main ducts, is normally treated by resection of the extrahepatic bile ducts, often with pancreaticoduodenectomy. Survival is similar. Due to the high rates of locoregional recurrences or positive surgical margins, many patients get treated with postoperative adjuvant radiotherapy. Its effect on survival has not been assessed. Intraluminal brachyradiotherapy has also shown some promise. However, photodynamic therapy enhanced survival in one study. In this technique, sodium porfimer is injected IV and then subjected to intraluminal red light laser photoactivation. OLTX has been assessed for treatment of unresectable CCC, but 5-year survival was previously ~20%, so enthusiasm waned. However, neoadjuvant radiotherapy with sensitizing chemotherapy has shown better survival rates for CCC treated by OLTX from one institution; confirmation is needed. Multiple chemotherapeutic agents have been assessed for activity and survival in unresectable CCC. Most have been inactive. However, both systemic and hepatic arterial gemcitabine have shown promising results. The combination of this drug with others and with radiotherapy is being explored.

### **GALLBLADDER CANCER (GB Ca)**

GB Ca has an even worse prognosis than CCC, with typical survival ~6 months or less. Women are affected much more commonly than men (4:1), unlike in HCC or CCC, and GB Ca is more common than CCC. Most patients have a history of gallstones, but very few patients with gallstones develop GB Ca (~0.2%). It presents similarly to CCC and is often diagnosed unexpectedly during gallstone or cholecystitis surgery. Presentation is typically that of chronic cholecystitis, chronic right upper quadrant pain and weight loss. Useful but nonspecific serum markers include CEA and CA 19-9. CT scans or MRCP typically reveal a gallbladder mass. The mainstay of treatment is surgical, either simple or radical cholecystectomy for stages I or II disease, respectively. Survival is nearly 100% at 5 years for stage I, and ranges from 60–90% at 5 years for stage II. More advanced GB Ca has worse survival, and many are unresectable. Adjuvant radiotherapy, used in the presence of local lymph node disease, has not been shown to enhance survival.

### **EPITHELIOID HEMANGIOENDOTHELIOMA (EHE)**

This rare vascular tumor of adults is also usually multifocal and can also be associated with prolonged survival, even in the presence of metastases, which are commonly in the lung. There is usually no underlying cirrhosis. Histologically, these tumors are usually of borderline malignancy and express factor VIII antigen, confirming their endothelial origin. OLTX may be associated with prolonged survival.

### **CHOLANGIOCARCINOMA (CCC)**

CCC typically refers to mucin-producing adenocarcinomas (different from HCC) that arise from the bile ducts. They are grouped by their anatomic site of origin as intrahepatic, hilar (central, ~65% of CCCs), and peripheral (or distal, ~30% of CCCs). They arise on the basis of cirrhosis less frequently than HCC, excepting primary biliary cirrhosis. Nodular tumors arising at the bifurcation of the common bile duct are called *Klatskin tumors* and are often associated with a collapsed gallbladder, a finding that mandates visualization of the entire biliary tree. The approach to management of central and peripheral CCC is quite different. The incidence seems to be increasing in the United States. Although most CCCs have no obvious cause, several predisposing factors have been identified, including primary sclerosing cholangitis, an autoimmune disease (10–20% of PSC patients), and liver fluke in Asians, especially *Opisthorchis viverrini* and *Clonorchis sinensis*. CCC seems also to be associated with any cause of chronic biliary inflammation and injury, with alcoholic liver disease, choledocholithiasis, choledochal cysts (10%), and Caroli's disease. CCC most typically presents as painless jaundice, often with pruritus or weight loss, and acholic stools. Diagnosis is made by biopsy, percutaneously for peripheral liver lesions or, more commonly, via endoscopic retrograde cholangiopancreatography (ERCP) under direct vision for central lesions. The tumors often stain positively for cytokeratins 7, 8, and 19 and negatively for cytokeratin 20. However, histology alone cannot usually distinguish CCC from metastases from primary tumors of the colon or pancreas. Serologic tumor markers appear to be nonspecific, but CEA, CA 19-9, and CA-125 are often elevated in CCC patients and are useful for following response to therapy. Radiologic evaluation typically starts with ultrasound, which is useful in visualizing dilated bile ducts, and then proceeds with either MRI or magnetic resonance cholangiopancreatography (MRCP) or helical CT scans. Invasive ERCP is then needed to define the biliary tree and obtain a biopsy or is needed therapeutically to decompress an obstructed biliary tree with internal stent placement. If that fails, then percutaneous biliary drainage will be needed, with

## CARCINOMA OF THE AMPULLA OF VATER

This tumor arises within 2 cm of the distal end of the common bile duct and is mainly (90%) an adenocarcinoma. Locoregional lymph nodes are commonly involved (50%), and the liver is the most frequent site for metastases. The commonest clinical presentation is jaundice, and many patients also have pruritus, weight loss, and epigastric pain. Initial evaluation is performed with an abdominal ultrasound to assess vascular involvement, biliary dilatation, and liver lesions. This is followed by a CT scan, or MRI and especially MRCP. The most effective therapy is resection by pylorus-sparing pancreaticoduodenectomy, an aggressive procedure resulting in better survival rates than local resection. Survival rates are ~25% at 5 years in operable patients with involved lymph nodes and ~50% in patients without involved nodes. Unlike CCC, ~80% of patients are thought to be resectable at diagnosis. Adjuvant chemotherapy or radiotherapy has not been shown to be useful in enhancing survival. For metastatic tumors, chemotherapy is currently experimental.

## TUMORS METASTATIC TO THE LIVER

These are predominantly from colon, pancreas, and breast primary tumors but can originate from any organ primary. Ocular melanomas are prone to liver metastasis. Tumor spread to the liver normally carries a poor prognosis for that tumor type. Colorectal and breast hepatic metastases were previously treated with continuous hepatic arterial infusion chemotherapy. However, more effective systemic drugs for these cancers, especially the addition of oxaliplatin to colorectal cancer regimens, have reduced the use of hepatic artery infusion therapy. In a large randomized study of systemic versus infusional plus systemic chemotherapy for resected colorectal metastases to the liver, the patients receiving infusional therapy had no survival advantage, mainly due to extrahepatic tumor spread. <sup>90</sup>Yttrium resin beads are approved in the United States for treatment of colorectal hepatic metastases. The role of this modality, either alone or in combination with chemotherapy, is being evaluated in many centers. Palliation may be obtained from chemoembolization, PEI, or RFA.

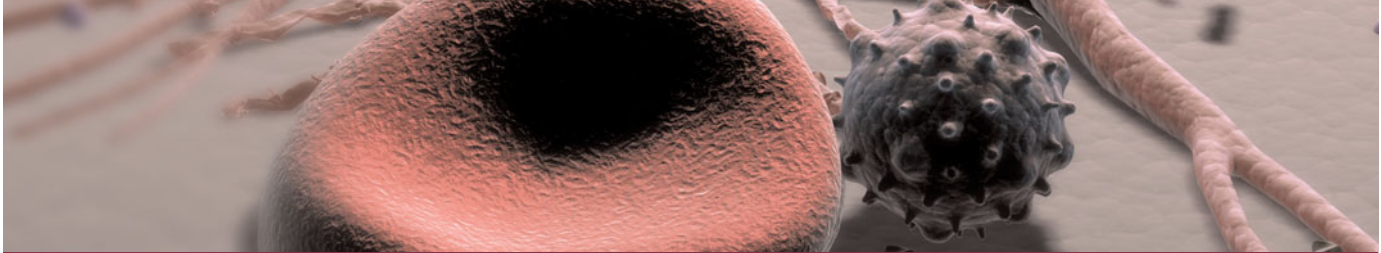
## BENIGN LIVER TUMORS

Three common benign tumors occur and all are found predominantly in women. They are *hemangiomas*, *adenomas*, and *focal nodular hyperplasia* (FNH). FNH is typically benign, and usually no treatment is needed. Hemangiomas

are the most common and entirely benign. Treatment is unnecessary unless their expansion causes symptoms. Adenomas are associated with contraceptive hormone use. They can cause pain and can bleed or rupture, causing acute problems. Their main interest for the physician is a low potential for malignant change and a 30% risk of bleeding. For this reason, considerable effort has gone into differentiating these three entities radiologically. Upon discovery of a liver mass, patients are usually advised to stop taking sex steroids because adenoma regression may then occasionally occur. Adenomas can often be large masses ranging from 8–15 cm. Due to their size and definite, but low malignant potential and potential for bleeding, adenomas are typically resected. The most useful diagnostic differentiating tool is a triphasic CT scan performed with HCC fast bolus protocol for arterial-phase imaging, together with subsequent delayed venous-phase imaging. Adenomas usually do not appear on the basis of cirrhosis, although both adenomas and HCCs are intensely vascular on the CT arterial phase and both can exhibit hemorrhage (40% of adenomas). However, adenomas have smooth, well-defined edges and enhance homogeneously, especially in the portal venous phase on delayed images, when HCCs no longer enhance. FNHs exhibit a characteristic central scar that is hypovascular on the arterial-phase and hypervascular on the delayed-phase CT images. MRI is even more sensitive in depicting the characteristic central scar of FNH.

## FURTHER READINGS

- BARTLETT DL: Intrahepatic cholangiocarcinoma: A worthy challenge. *Cancer J* 15:255, 2009
- FURUKAWA H et al: Living-donor liver transplantation for hepatocellular carcinoma. *J Hepatobiliary Pancreat Surg* 13:393, 2006
- GALLEGOS-OROZCO JF, VARGAS HE: Liver transplantation: from Child to MELD. *Med Clin North Am* 93:931, 2009
- GOIN JE et al: Treatment of unresectable hepatocellular carcinoma with intrahepatic yttrium 90 microspheres. *J Vasc Interv Radiol* 16:161, 2005
- LLOVET JM et al: A molecular signature to discriminate dysplastic nodules from early hepatocellular carcinoma. *Gastroenterology* 131:1758, 2006
- MENDIZABAL M, REDDY KR: Current management of hepatocellular carcinoma. *Med Clin North Am* 93:885, 2009
- PARIKH S, HYMAN D: Hepatocellular cancer: A guide for the internist. *Am J Med* 120:194, 2007
- STEEL JL et al: Clinically meaningful changes in health-related quality of life in patients with hepatobiliary cancer. *Ann Oncol* 17:304, 2006
- THORGEIRSSON S et al: Molecular prognostication of liver cancer: End of the beginning. *J Hepatol* 44:798, 2006
- VERSLYPE C et al: The management of hepatocellular carcinoma. Current expert opinion and recommendations derived from the 10th World Congress on Gastrointestinal Cancer, Barcelona, 2008. *Ann Oncol* 20 (suppl 7):vii1, 2009



## CHAPTER 37

# PANCREATIC CANCER

Yu Jo Chua ■ David Cunningham

Incidence and Etiology . . . . .	.499
Genetic Considerations . . . . .	.499
Clinical Features . . . . .	.500
Diagnostic Procedures . . . . .	.500
■ Further Readings . . . . .	.503

Over 90% of pancreatic cancers are ductal adenocarcinomas of the exocrine pancreas. These tumors occur twice as frequently in the pancreatic head compared to the rest of the organ, and they tend to be aggressive, often presenting when locally inoperable or after distal metastases have occurred. Patients with pancreatic cancer have a poor prognosis, with a 5-year survival of only 5%. The discussion of pancreatic cancer here is limited to ductal adenocarcinomas. Other types of pancreatic neoplasms include islet cell tumors and neuroendocrine tumors (Chap. 46).

### INCIDENCE AND ETIOLOGY


#### Epidemiology

The lifetime risk of being diagnosed with pancreatic cancer in the United States is 1.27%. In the United States, it was estimated that ~37,170 people would be diagnosed with pancreatic cancer in 2007. Consistent with its associated poor prognosis, 33,370 were expected to die from this disease in the same year, making it the fourth leading cause of cancer-related death. The median age of diagnosis of pancreatic cancer is 72 years, with the peak incidence of diagnosis between the ages of 65 and 84; it is rarely diagnosed in those <50 years of age. The incidence is slightly higher in men than women, and it is also higher in African Americans than in whites.

#### Etiology

Cigarette smoking, obesity, and nonhereditary chronic pancreatitis appear to be risk factors for the development of pancreatic cancer. With smoking, the risk seems to increase with the number of cigarettes consumed and decreases with smoking cessation. Less clear, and sometimes conflicting associations, have been observed for other environmental factors such as diet, coffee and alcohol consumption, previous partial gastrectomy or cholecystectomy, and *Helicobacter pylori*. An epidemiologic association between diabetes mellitus and pancreatic cancer has also been demonstrated; however, it is uncertain if diabetes is a precedent of, or consequence of, pancreatic cancer.

### GENETIC CONSIDERATIONS

 Five to 10% of patients with pancreatic cancer also have an affected first-degree relative, suggesting that in some cases genetic factors are involved. These patients seem to present earlier than sporadic cases. The risk of pancreatic cancer is increased in certain syndromes, whether directly or indirectly, such as hereditary chronic pancreatitis, Peutz-Jeghers syndrome, Von Hippel-Lindau syndrome, familial atypical multiple-mole melanoma syndrome, ataxia-telangiectasia, Gardner's syndrome [a variant of familial adenomatous polyposis (FAP)] and Lynch's syndrome II, a subtype of hereditary

nonpolyposis colorectal cancer (HNPCC). Heavy smokers who also have homozygous deletions of the gene for glutathione-S transferase T1 (GSTT1), a carcinogen metabolizing enzyme, may be at particular risk. Activating mutations in the *K-ras* oncogene are found in nearly all pancreatic cancer. Loss-of-function mutations in several tumor suppressor genes occur in this disease, including p53, *CDKN2A* gene (also called multiple tumor suppressor-1 gene, leading in many cases to loss of function of p16), *DPC4*, and *BRCA2*. A feature almost unique to pancreatic cancer is the combination of *K-ras* and *CDKN2A* mutations.

## CLINICAL FEATURES

### Presenting Features

Common presenting features of pancreatic cancer include pain (present in >80% of patients with locally advanced or metastatic disease), obstructive jaundice, weight loss, and anorexia. Patients with jaundice may also have pruritus, pale stools, and dark urine; they often have tumors in the pancreatic head and tend to be diagnosed earlier and with earlier stage disease. Other symptoms tend to be more insidious, so that in the absence of jaundice, the interval between onset and diagnosis can be prolonged. Pain, for example, is often more of a problem in patients with lesions in the body or tail of the pancreas where the primary tumor is more likely to become quite large or to invade adjacent structures (such as the splanchnic nerves) before becoming manifest; these patients frequently have inoperable disease. When present, pain is often felt as a dull ache in the upper abdomen and may radiate to the back, and characteristically may improve upon leaning forward. It may initially be intermittent and may worsen with meals. These patients may suffer from marked weight loss, which may result from a combination of anorexia, early satiety, malabsorption, or diarrhea/steatorrhea. Other less common presenting features include the diagnosis of glucose intolerance (particularly within 2 years of cancer diagnosis), previous pancreatitis, migratory superficial thrombophlebitis (Trousseau's syndrome), gastrointestinal hemorrhage from varices, and splenomegaly.

### Physical Findings

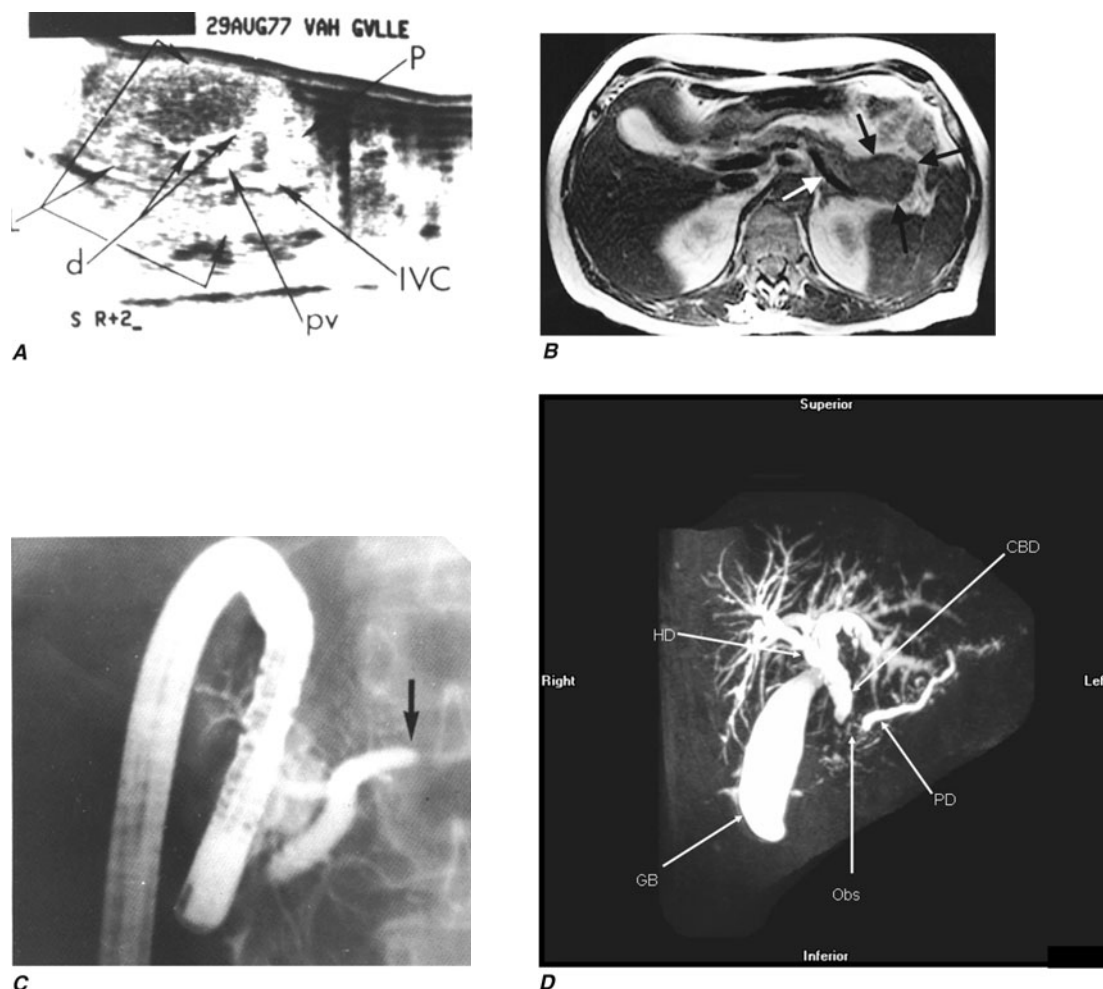
Patients with early disease may not have any significant abnormalities detectable on physical examination. Jaundice may be a presenting feature in some; in these patients a palpable, nontender gallbladder (Courvoisier's sign) may be palpated under the right costal margin. Patients with more advanced disease may have an abdominal mass, hepatomegaly, splenomegaly, or ascites. The left supraclavicular lymph node (Virchow's node) may be involved with tumor, or widespread peritoneal

disease may be palpable on rectal examination in the pouch of Douglas.

## DIAGNOSTIC PROCEDURES

### Imaging Studies

(Fig. 37-1) Ultrasound is often used as an initial investigation for patients with jaundice, or with less specific symptoms such as upper abdominal discomfort, and is able to assess the biliary tract, gallbladder, pancreas, and liver. Computed tomography (CT) scanning is preferable to ultrasound even though it is more costly, because it is less operator-dependent, more reproducible, and less susceptible to interference from intestinal gas. The sensitivity and specificity of CT is markedly improved by the use of pancreatic protocol scanning on modern multislice scanners. CT may show a pancreatic mass, dilatation of the biliary system or pancreatic duct, or distal spread to the liver, regional lymph nodes, or peritoneum (and/or associated ascites). When helical CT is combined with the use of intravenous contrast, it may also help determine resectability by providing information on the involvement of important vascular structures such as the celiac axis, superior mesenteric, or portal vessels. Endoscopic retrograde cholangiopancreatography (ERCP) is also widely used in the diagnosis of pancreatic cancer, particularly when CT and ultrasound fail to show a mass lesion, and it may reveal either stricture or obstruction in either the pancreatic or common bile duct. ERCP can also be used to obtain brushings of a stricture for cytology or for placing stents in order to relieve obstructive jaundice. Endoscopic ultrasound (EUS) may be useful in the diagnosis of small lesions (<2–3 cm in diameter) and, in some cases, for local staging as well as evaluating invasion of major vascular structures. EUS-guided fine-needle aspiration may also be used to obtain cytology for confirming the diagnosis, particularly in patients with potentially operable disease (see later). Although magnetic resonance imaging (MRI) does not offer any advantages over CT in the routine evaluation of patients with possible pancreatic cancer, magnetic resonance cholangiopancreatography (MRCP) may be better than CT for defining the anatomy of the pancreatic duct and biliary tree, being able to image the ducts both above and below a stricture. The sensitivity of MRCP is comparable to ERCP but does not require contrast administration to the ductal system, so there is less associated morbidity. MRCP may be useful when cannulation of the pancreatic duct by ERCP has been unsuccessful or may be difficult, such as when normal anatomy is changed by surgery. Positron emission tomography with <sup>18</sup>F-fluoro-2-deoxyglucose (FDG-PET) may be useful for excluding occult distal metastasis in patients with localized disease who are being worked up for surgery or in patients with unresectable localized disease being considered for chemoradiotherapy.



**FIGURE 37-1**

**Carcinoma of the pancreas.** **A.** Sonogram showing pancreatic carcinoma (P), dilated intrahepatic bile ducts (d), dilated portal vein (pv), and inferior vena cava (IVC). **B.** Computed tomography scan showing pancreatic carcinoma (dark arrows). **C.** Endoscopic retrograde showing abrupt cutoff of the duct of

Wirsung (arrow). **D.** Magnetic resonance cholangiopancreatography showing obstruction (Obs) in the pancreatic duct (PD). The gallbladder (GB), hepatic duct (HD), and common bile duct (CBD) are labeled.

### Tissue Diagnosis and Cytology

Patients with disease that is potentially curable by surgery, and in whom a highly suspicious lesion is seen on imaging, are often taken directly to surgery without prior tissue confirmation of cancer. This is because of theoretical concerns that a percutaneous fine-needle aspiration may result in dissemination of cancer intraperitoneally or along the track of the biopsy needle. In addition, negative cytology may not be sufficient evidence to avoid surgery, particularly with small lesions. EUS-guided fine-needle aspiration is increasingly being used, even in patients with potentially resectable disease, because there is less risk of intraperitoneal spread of cancer. Other methods of obtaining specimens for cytological analysis include sampling of pancreatic juices or brushings of ductal lesions obtained by ERCP.

### Serum Markers

The most widely used serum marker in pancreatic cancer is cancer-associated antigen 19-9 (CA 19-9). It has a reported sensitivity and specificity of ~80–90% and is suggestive, rather than confirmatory, of the diagnosis of pancreatic cancer. Serum levels of CA 19-9 can be elevated in patients with jaundice without pancreatic cancer present. The level of CA 19-9 may have prognostic implications, with very high levels sometimes found in patients with inoperable disease. In advanced disease, patients treated with chemotherapy who had high pre-treatment levels of CA 19-9 have also been found to have a worse survival, whereas those patients whose levels of marker fell with treatment had a better outcome. In patients with cancers with elevated CA 19-9, serial evaluation of this marker is useful for monitoring

## STAGING OF PANCREATIC CARCINOMA

	STAGE GROUPING	TNM STAGING <sup>a</sup>
Localized resectable	I	T1–2 N0 M0
	II	T3 N0 M0 or T1–3 N1 M0
Locally advanced	III	T4 N(any) M0
Metastatic	IV	T(any) N(any) M1

<sup>a</sup>TNM, tumor, nodes, metastasis.

**Note:** T1, tumor limited to pancreas,  $\leq 2$  cm; T2, tumor limited to pancreas,  $> 2$  cm; T3, tumor extends beyond the pancreas but without involvement of celiac axis or superior mesenteric artery; T4, tumor involves celiac axis or the superior mesenteric artery (unresectable primary tumor); N0, no regional lymph node metastasis (regional lymph nodes are the peripancreatic lymph nodes, including the lymph nodes along the hepatic artery, celiac axis and pyloric/splenic regions); N1, regional lymph node metastasis; M0, no distal metastasis; M1, distal metastasis.

**Source:** Modified from Greene, Page; with permission.

responses to treatment. In patients with completely resected tumors, follow-up with CA 19-9 is useful for detecting recurrence.

### Staging

In pancreatic cancer, which has a poor prognosis, the value of detailed clinical staging is limited. The most clinically relevant distinction to make is between patients with disease that may be resected with curative intent, and those with advanced disease in whom treatment is palliative (Table 37-1).

### Surveillance in High-Risk Individuals

Routine screening for pancreatic cancer is not recommended due to a high false-positive rate of the available tests. However, screening may be reasonable in certain high-risk individuals, such as those with strong family histories, although the optimal timing, frequency, and method of screening is unknown. One recommendation is to commence screening at the age of 35 in patients with hereditary pancreatitis, or 10 years before the age of the youngest diagnosis of pancreatic cancer in those with a significant family history using spiral CT, followed by EUS when CT results have been indeterminate.

### **Rx** Treatment: PANCREATIC CANCER

Symptoms and the associated impaired performance status are significant issues in the management of patients with pancreatic cancer because they can have a marked negative impact on the ability to safely deliver

chemotherapy or perform curative surgery. For example, patients with malabsorption secondary to pancreatic insufficiency may be treated with pancreatic enzyme supplementation. Indeed effective symptom management is as important a therapeutic goal as survival prolongation.

**ADVANCED PANCREATIC CANCER** These patients have metastatic or locally advanced inoperable disease and are the majority with newly diagnosed disease. Debulking surgery or partial resections have no role because these procedures are associated with the same risks as a curative resection but are unlikely to improve survival. Many patients may, however, benefit from endoscopic biliary or duodenal stenting, and some patients from nerve plexus blocks or ablation. Less frequently, intestinal bypass surgery is required.

The deoxycytidine analogue gemcitabine, given as a single agent (gemcitabine, 1000 mg/m<sup>2</sup>, weekly for 7 weeks followed by 1 week rest, then weekly for 3 weeks every 4 weeks thereafter), has been the preferred treatment for these patients because it was shown to yield clinical benefit (a composite parameter for evaluating symptomatic benefit of treatment used in some trials of this disease) and improved survival compared to 5-fluorouracil. The median survival observed with single-agent gemcitabine in randomized trials is ~6 months, with a 12-month survival of ~18%. Furthermore, two randomized trials have shown improved survival from the addition of either the oral fluoropyrimidine, capecitabine (gemcitabine, 1000 mg/m<sup>2</sup>, days 1, 8, and 15 plus capecitabine, 1660 mg/m<sup>2</sup>, days 1–21, repeated every 28 days), or the tyrosine kinase inhibitor of the epidermal growth factor receptor (EGFR), erlotinib (standard gemcitabine plus erlotinib, 100 mg daily). The survival improvement observed with both of these combinations appears similar, and the addition of capecitabine to gemcitabine in this regimen does not appear to increase the toxicity above single-agent gemcitabine. Either combination should, therefore, be considered as options for treating these patients. Second-line treatment options in pancreatic cancer are limited, although there may be an emerging role for oxaliplatin-based chemotherapy; fit patients who have failed first-line treatment should be offered entry into clinical trials. Ongoing clinical trials are evaluating the potential benefits of incorporating other novel targeted agents into the treatment of pancreatic cancer, usually together with gemcitabine.

In patients with locally advanced unresectable disease, external beam chemoradiotherapy may be useful, either as initial treatment or as consolidation after induction chemotherapy.

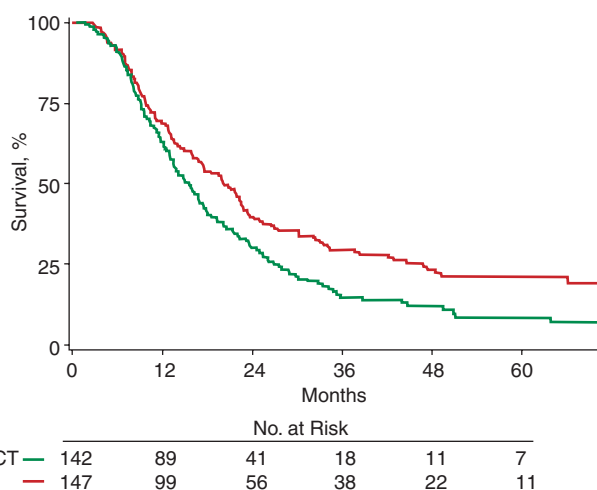
**OPERABLE DISEASE** Complete surgical resection in patients with localized disease (stage I or II disease),

with distal metastases excluded by prior CT scan of the abdomen and pelvis, and CT of the chest or chest x-ray is potentially curative. However, such surgery is only possible in 10–15% of patients, many of whom will suffer from recurrences of their disease. Indeed, the 5-year survival reported in randomized trials with surgery alone is ~10%, although modern series have improved on these results. Outcomes tend to be more favorable in patients with lymph node–negative disease, smaller tumors (<3 cm), negative resection margins, and well-differentiated tumors. Despite a dismal long-term outcome, these patients still have a better survival with surgery than with other palliative measures.

Surgery is usually preceded by laparoscopy in order to exclude peritoneal metastases not seen on other staging investigations. Pancreaticoduodenectomy, also known as the Whipple procedure, is the standard operation for cancers of the head or uncinate process of the pancreas. The procedure involves resection of the pancreatic head, duodenum, first 15 cm of the jejunum,

common bile duct, and gallbladder, and a partial gastrectomy, with the pancreatic and biliary anastomosis placed 45–60 cm proximal to the gastrojejunostomy. Perioperative mortality rates have fallen to <5%, reflecting greater experience with the surgery and perioperative management of these patients. However, this type of surgery is highly specialized and should ideally only occur in dedicated centers with a high volume of these cases and specialized surgeons.

Adjuvant treatment for patients with curatively resected pancreatic cancer is controversial, with divergent treatment approaches preferred in the United States and in Europe, based on the results of different randomized trials conducted on both sides of the Atlantic. In the United States, fluoropyrimidine-based postoperative chemoradiotherapy followed by adjuvant chemotherapy is preferred. In Europe, because a large randomized trial (the European Study Group for Pancreatic Cancer 1, or ESPAC1 trial) showed a survival benefit for adjuvant chemotherapy with 5-fluorouracil (5FU) (**Fig. 37-2**), this approach is more common practice.



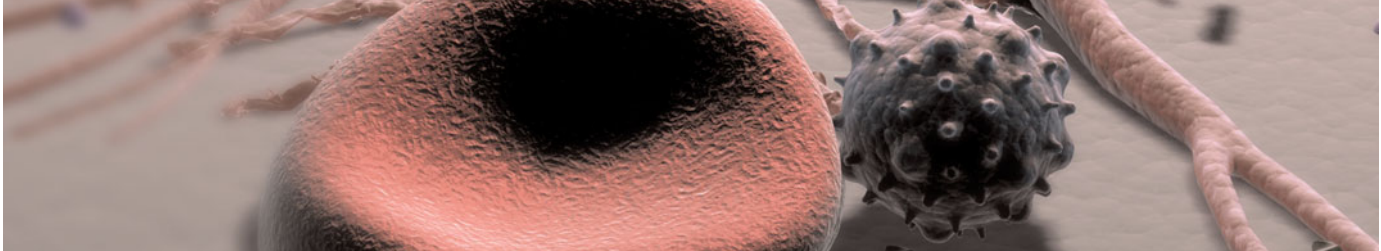
**FIGURE 37-2**

**Survival by adjuvant chemotherapy.** Kaplan-Meier estimates of survival from the European Study Group for Pancreatic Cancer 1 (ESPAC1) trial for the comparison of adjuvant chemotherapy versus no adjuvant chemotherapy (CT) in patients with resected pancreatic cancer (hazard ratio for death, 0.71; 95% confidence interval, 0.55–0.92;  $p = 0.009$ ). (Reprinted with permission from JP Neoptolemos, DD Stocken, H Friess, et al: *A randomized trial of chemoradiotherapy and chemotherapy after resection of pancreatic cancer*. *N Engl J Med* 350:1200–1210, 2004. Copyright 2004, Massachusetts Medical Society.)

## FURTHER READINGS

- ALEXAKIS N et al: Current standards of surgery for pancreatic cancer. *Br J Surg* 91:1410, 2004
- BARUGOLA G et al: The determinant factors of recurrence following resection for ductal pancreatic cancer. *JOP* 8(Suppl 1):132, 2007
- CHANG DK et al: Role of endoscopic ultrasound in pancreatic cancer. *Expert Rev Gastroenterol Hepatol* 3:293, 2009
- CHUA YJ, CUNNINGHAM D: Chemotherapy for advanced pancreatic cancer. *Best Pract Res Clin Gastroenterol* 20:327, 2006
- DIMAGNO EP et al: AGA technical review on the epidemiology, diagnosis, and treatment of pancreatic ductal adenocarcinomas. American Gastroenterological Association. *Gastroenterology* 117:1464, 1999
- GREENE FL, PAGE DL (eds): *Exocrine Pancreas, AJCC Cancer Staging Manual*, 6th ed, New York, Springer, pp 157–164, 2002
- HRUBAN RH, ADSAY NV: Molecular classification of neoplasms of the pancreas. *Hum Pathol* 40:612, 2009
- HUSER N et al: Systematic review and meta-analysis of prophylactic gastroenterostomy for unresectable advanced pancreatic cancer. *Br J Surg* 96:711, 2009
- NEOPTOLEMOS JP et al: A randomized trial of chemoradiotherapy and chemotherapy after resection of pancreatic cancer. *N Engl J Med* 350:1200, 2004
- WILLETT CG et al: Locally advanced pancreatic cancer. *J Clin Oncol* 23:4538, 2005
- YEH JJ: Prognostic signature for pancreatic cancer: Are we close? *Future Oncol* 5:313, 2009





## CHAPTER 38

# BLADDER AND RENAL CELL CARCINOMAS

Howard I. Scher ■ Robert J. Motzer

■ Bladder Cancer . . . . .	.504	■ Renal Cell Carcinoma . . . . .	.508
Epidemiology . . . . .	.504	Epidemiology . . . . .	.508
Pathology . . . . .	.504	Pathology and Genetics . . . . .	.508
Pathogenesis . . . . .	.505	Clinical Presentation . . . . .	.509
Clinical Presentation, Diagnosis, and Staging . . . . .	.505	Staging and Prognosis . . . . .	.509
■ Carcinoma of the Renal Pelvis and Ureter . . . . .	.508	■ Further Readings . . . . .	.510

### BLADDER CANCER

A transitional cell epithelium lines the urinary tract from the renal pelvis to the ureter, urinary bladder, and the proximal two-thirds of the urethra. Cancers can occur at any point: 90% of malignancies develop in the bladder, 8% in the renal pelvis, and the remaining 2% in the ureter or urethra. Bladder cancer is the fourth most common cancer in men and the thirteenth in women, with an estimated 67,160 new cases and 13,750 deaths in the United States predicted for the year 2007. The almost 5:1 ratio of incidence to mortality reflects the higher frequency of the less lethal superficial variants compared to the more lethal invasive and metastatic variants. The incidence is three times higher in men than in women, and twofold higher in whites than blacks, with a median age at diagnosis of 65 years.

Once diagnosed, urothelial tumors exhibit polychronotropism—the tendency to recur over time and in new locations in the urothelial tract. As long as urothelium is present, continuous monitoring of the tract is required.

### EPIDEMIOLOGY



Cigarette smoking is believed to contribute to up to 50% of the diagnosed urothelial cancers in men and up to 40% in women. The risk of developing a urothelial malignancy in male smokers is increased two- to fourfold relative to nonsmokers and

continues for  $\geq 10$  years after cessation. Other implicated agents include the aniline dyes, the drugs phenacetin and chlornaphazine, and external beam radiation. Chronic cyclophosphamide exposure may also increase risk, whereas vitamin A supplements appear to be protective. Exposure to *Schistosoma haematobium*, a parasite found in many developing countries, is associated with an increase in both squamous and transitional cell carcinomas of the bladder.

### PATHOLOGY

Clinical subtypes are grouped into three categories: 75% are superficial, 20% invade muscle, and 5% are metastatic at presentation. Staging of the tumor within the bladder is based on the pattern of growth and depth of invasion: Ta lesions grow as exophytic lesions; carcinoma in situ (CIS) lesions start on the surface and tend to invade. The revised tumor, node, metastasis (TNM) staging system is illustrated in **Fig. 38-1**. About half of invasive tumors presented originally as superficial lesions that later progressed. Tumors are also rated by grade. Grade I lesions (highly differentiated tumors) rarely progress to a higher stage, whereas grade III tumors do.

More than 95% of urothelial tumors in the United States are transitional cell in origin. Pure squamous cancers with keratinization constitute 3%, adenocarcinomas 2%, and small cell tumors (with paraneoplastic syndromes)  $< 1\%$ . Adenocarcinomas develop primarily in the urachal remnant in the dome of the bladder or in

	STAGE	TNM	L.Nodes%	5-YEAR SURVIVAL
Superficial	Ois	Tis		90%
	Oa	Ta		
Superficial	I	T1		
Infiltrating	II	T2 T3a	7-30 26	70%
	III	T3b	50	35-50%
Invasion of adjacent structures	IV	T4	70	10-20%
Lymph node invasion	IV	N+	100	
Distant extension	IV	M+	100	
		M+	60	

FIGURE 38-1

Bladder staging. TNM, tumor, node, metastasis.

the periurethral tissues; some assume a signet cell histology. Lymphomas and melanomas are rare. Of the transitional cell tumors, low-grade papillary lesions that grow on a central stalk are most common. These tumors are very friable, have a tendency to bleed, are at high risk for recurrence, and yet rarely progress to the more lethal invasive variety. In contrast, CIS is a high-grade tumor that is considered a precursor of the more lethal muscle-invasive disease.

## PATHOGENESIS

The multicentric nature of the disease and high rate of recurrence has led to the hypothesis of a field defect in the urothelium that results in a predisposition to cancer. Molecular genetic analyses suggest that the superficial and invasive lesions develop along distinct molecular pathways in which primary tumorigenic aberrations precede secondary changes associated with progression to a more advanced stage. Low-grade papillary tumors that do not tend to invade or metastasize harbor constitutive activation of the receptor-tyrosine kinase-Ras signal transduction pathway and a high frequency of

fibroblast growth factor receptor 3 (FGFR3) mutations. In contrast, CIS and invasive tumors have a higher frequency of *TP53* and *RB* gene alternations. Within all clinical stages, including Tis, T1, and T2 or greater lesions, tumors with alterations in *p53*, *p21*, and/or *RB* have a higher probability of recurrence, metastasis, and death from disease.

## CLINICAL PRESENTATION, DIAGNOSIS, AND STAGING

Hematuria occurs in 80–90% of patients and often reflects exophytic tumors. The bladder is the most common source of gross hematuria (40%), but benign cystitis (22%) is a more common cause than bladder cancer (15%). Microscopic hematuria is more commonly of prostate origin (25%); only 2% of bladder cancers produce microscopic hematuria. Once hematuria is documented, a urinary cytology, visualization of the urothelial tract by CT or intravenous pyelogram, and cystoscopy are recommended if no other etiology is found. Screening asymptomatic individuals for hematuria increases the diagnosis of tumors at an early stage but has not been

shown to prolong life. After hematuria, irritative symptoms are the next most common presentation, which may reflect in situ disease. Obstruction of the ureters may cause flank pain. Symptoms of metastatic disease are rarely the first presenting sign.

The endoscopic evaluation includes an examination under anesthesia to determine whether a palpable mass is present. A flexible endoscope is inserted into the bladder, and bladder barbotage is performed. The visual inspection includes mapping the location, size, and number of lesions, as well as a description of the growth pattern (solid vs papillary). An intraoperative video is often recorded. All visible tumors should be resected, and a sample of the muscle underlying the tumor should be obtained to assess the depth of invasion. Normal-appearing areas are biopsied at random to ensure no field defect. A notation is made as to whether a tumor was completely or incompletely resected. Selective catheterization and visualization of the upper tracts should be performed if the cytology is positive and no disease is visible in the bladder. Ultrasonography, CT, and/or MRI may help to determine whether a tumor extends to perivesical fat (T3) and to document nodal spread. Distant metastases are assessed by CT of the chest and abdomen, MRI, or radionuclide imaging of the skeleton.

### **Rx Treatment:** **BLADDER CANCER**

Management depends on whether the tumor invades muscle and whether it has spread to the regional lymph nodes and beyond. The probability of spread increases with increasing T stage.

**SUPERFICIAL DISEASE** At a minimum, the management of a superficial tumor is complete endoscopic resection with or without intravesical therapy. The decision to recommend intravesical therapy depends on the histologic subtype, number of lesions, depth of invasion, presence or absence of CIS, and antecedent history. Recurrences develop in upward of 50% of cases, of which 5–20% progress to a more advanced stage. In general, solitary papillary lesions are managed by transurethral surgery alone. CIS and recurrent disease are treated by transurethral surgery followed by intravesical therapy.

Intravesical therapies are used in two general contexts: as an adjuvant to a complete endoscopic resection to prevent recurrence or, less commonly, to eliminate disease that cannot be controlled by endoscopic resection alone. Intravesical treatments are advised for patients with recurrent disease, >40% involvement of the bladder surface by tumor, diffuse CIS, or T1 disease. The standard intravesical therapy, based on randomized comparisons, is bacillus Calmette-

Guérin (BCG) in six weekly instillations, followed by monthly maintenance administrations for  $\geq 1$  year. Other agents with activity include mitomycin-C, interferon (IFN), and gemcitabine. The side effects of intravesical therapies include dysuria, urinary frequency, and, depending on the drug, myelosuppression or contact dermatitis. Rarely, intravesical BCG may produce a systemic illness associated with granulomatous infections in multiple sites that requires antituberculin therapy.

Following the endoscopic resection, patients are monitored for recurrence at 3-month intervals during the first year. Recurrence may develop anywhere along the urothelial tract, including the renal pelvis, ureter, or urethra. A consequence of the “successful” treatment of tumors in the bladder is an increase in the frequency of extravesical recurrences (e.g., urethra or ureter). Those with persistent disease or new tumors are generally considered for a second course of BCG or for intravesical chemotherapy with valrubicin or gemcitabine. In some cases cystectomy is recommended, although the specific indications vary. Tumors in the ureter or renal pelvis are typically managed by resection during retrograde examination or, in some cases, by instillation through the renal pelvis. Tumors of the prostatic urethra may require cystectomy if the tumor cannot be resected completely.

**INVASIVE DISEASE** The treatment of a tumor that has invaded muscle can be separated into control of the primary tumor and, depending on the pathologic findings at surgery, systemic chemotherapy. Radical cystectomy is the standard, although in selected cases a bladder-sparing approach is used; this approach includes complete endoscopic resection; partial cystectomy; or a combination of resection, systemic chemotherapy, and external beam radiation therapy. In some countries, external beam radiation therapy is considered standard. In the United States, its role is limited to those patients deemed unfit for cystectomy, those with unresectable local disease, or as part of an experimental bladder-sparing approach.

Indications for cystectomy include muscle-invading tumors not suitable for segmental resection; low-stage tumors unsuitable for conservative management (e.g., due to multicentric and frequent recurrences resistant to intravesical instillations); high-grade tumors (T1G3) associated with CIS; and bladder symptoms, such as frequency or hemorrhage, that impair quality of life.

Radical cystectomy is major surgery that requires appropriate preoperative evaluation and management. The procedure involves removal of the bladder and pelvic lymph nodes and creation of a conduit or reservoir for urinary flow. Grossly abnormal lymph nodes are evaluated by frozen section. If metastases are confirmed, the procedure is often aborted. In males, radical

cystectomy includes the removal of the prostate, seminal vesicles, and proximal urethra. Impotence is universal unless the nerves responsible for erectile function are preserved. In females, the procedure includes removal of the bladder, urethra, uterus, fallopian tubes, ovaries, anterior vaginal wall, and surrounding fascia.

Previously, urine flow was managed by directing the ureters to the abdominal wall, where it was collected in an external appliance. Currently, most patients receive either a continent cutaneous reservoir constructed from detubularized bowel or an orthotopic neobladder. Some 70% of men receive a neobladder. With a continent reservoir, 65–85% of men will be continent at night and 85–90% during the day. Cutaneous reservoirs are drained by intermittent catheterization; orthotopic neobladders are drained more naturally. Contraindications to a neobladder include renal insufficiency, an inability to self-catheterize, or an exophytic tumor or CIS in the urethra. Diffuse CIS in the bladder is a relative contraindication based on the risk of a urethral recurrence. Concurrent ulcerative colitis or Crohn's disease may hinder the use of resected bowel.

A partial cystectomy may be considered when the disease is limited to the dome of the bladder, a margin of at least 2 cm can be achieved, there is no CIS in other sites, and the bladder capacity is adequate after the tumor has been removed. This occurs in 5–10% of cases. Carcinomas in the ureter or in the renal pelvis are treated with nephroureterectomy with a bladder cuff to remove the tumor.

The probability of recurrence following surgery is predicted on the basis of pathologic stage, presence or absence of lymphatic or vascular invasion, and nodal spread. Among those whose cancers recur, the recurrence develops in a median of 1 year (range: 0.04–11.1 years). Long-term outcomes vary by pathologic stage and histology (Table 38-1). The number of lymph nodes removed is also prognostic, whether or not the nodes contained tumor.

Chemotherapy (described later) has been shown to prolong the survival of patients with invasive disease but only when combined with definitive treatment of the bladder by radical cystectomy or radiation therapy.

Thus, for most patients, chemotherapy alone is inadequate to clear the bladder of disease. Experimental studies are evaluating bladder preservation strategies by combining chemotherapy and radiation therapy in patients whose tumors were endoscopically removed.

**METASTATIC DISEASE** The primary goal of treatment for metastatic disease is to achieve complete remission with chemotherapy alone or with a combined-modality approach of chemotherapy followed by surgical resection of residual disease, as is done routinely for the treatment of germ cell tumors. One can define a goal in terms of cure or palliation on the basis of the probability of achieving a complete response to chemotherapy using prognostic factors, such as Karnofsky Performance Status (KPS) (<80%), and whether the pattern of spread is nodal or visceral (liver, lung, or bone). For those with zero, one, or two risk factors, the probability of complete remission is 38, 25, and 5%, respectively, and median survival is 33, 13.4, and 9.3 months, respectively. Patients who are functionally compromised or who have visceral disease or bone metastases rarely achieve long-term survival. The toxicities also vary as a function of risk, and treatment-related mortality rates are as high as 3–4% using some combinations in these poor-risk patient groups.

**CHEMOTHERAPY** A number of chemotherapeutic drugs have shown activity as single agents; cisplatin, paclitaxel, and gemcitabine are considered most active. Standard therapy consists of two-, three-, or four-drug combinations. Overall response rates of >50% have been reported using combinations such as methotrexate, vinblastine, doxorubicin, and cisplatin (M-VAC); cisplatin and paclitaxel (PT); gemcitabine and cisplatin (GC); or gemcitabine, paclitaxel, and cisplatin (GTC). M-VAC was considered standard, but the toxicities of neutropenia and fever, mucositis, diminished renal and auditory function, and peripheral neuropathy led to the development of alternative regimens. At present, GC is used more commonly than M-VAC, based on the results of a comparative trial of M-VAC versus GC that showed less neutropenia and fever, and less mucositis for the GC regimen. Anemia and thrombocytopenia were more common with GC. GTC is not more effective than GC.

Chemotherapy has also been evaluated in the neoadjuvant and adjuvant settings. In a randomized trial, patients receiving three cycles of neoadjuvant M-VAC followed by cystectomy had a significantly better median (6.2 years) and 5-year survival (57%) compared to cystectomy alone (median survival: 3.8 years; 5-year survival: 42%). Similar results were obtained in an international study of three cycles of cisplatin, methotrexate, and vinblastine (CMV) followed by either radical cystectomy or radiation therapy. The decision to administer adjuvant therapy is based on the risk of recurrence after

**TABLE 38-1**

**SURVIVAL FOLLOWING SURGERY FOR BLADDER CANCER**

<b>PATHOLOGIC STAGE</b>	<b>5-YEAR SURVIVAL, %</b>	<b>10-YEAR SURVIVAL, %</b>
T2,N0	89	87
T3a,N0	78	76
T3b,N0	62	61
T4,N0	50	45
Any T,N1	35	34

## MANAGEMENT OF BLADDER CANCER

NATURE OF LESION	MANAGEMENT APPROACH
Superficial	Endoscopic removal, usually with intravesical therapy
Invasive disease	Cystectomy ± systemic chemotherapy (before or after surgery)
Metastatic disease	Curative or palliative chemotherapy (based on prognostic factors) ± surgery

cystectomy. Indications for adjuvant chemotherapy include the presence of nodal disease, extravesical tumor extension, or vascular invasion in the resected specimen. Another study of adjuvant therapy found that four cycles of CMV delayed recurrence, although an effect on survival was less clear. Additional trials are studying taxane- and gemcitabine-based combinations.

The management of bladder cancer is summarized in [Table 38-2](#).

### CARCINOMA OF THE RENAL PELVIS AND URETER



About 2500 cases of renal pelvis and ureter cancer occur each year; nearly all are transitional cell carcinomas similar to bladder cancer in biology and appearance. This tumor is also associated with chronic phenacetin abuse and with Balkan nephropathy, a chronic interstitial nephritis endemic in Bulgaria, Greece, Bosnia-Herzegovina, and Romania.

The most common symptom is painless gross hematuria, and the disease is usually detected on intravenous pyelogram during the workup for hematuria. Patterns of spread are like those in bladder cancer. For low-grade disease localized to the renal pelvis and ureter, nephroureterectomy (including excision of the distal ureter with a portion of the bladder) is associated with 5-year survival of 80–90%. More invasive or histologically poorly differentiated tumors are more likely to recur locally and to metastasize. Metastatic disease is treated with the chemotherapy used in bladder cancer, and the outcome is similar to that of metastatic transitional cell cancer of bladder origin.

### RENAL CELL CARCINOMA

Renal cell carcinomas account for 90–95% of malignant neoplasms arising from the kidney. Notable features include resistance to cytotoxic agents, infrequent responses to biologic response modifiers such as interleukin (IL) 2,

and a variable clinical course for patients with metastatic disease, including anecdotal reports of spontaneous regression.

### EPIDEMIOLOGY

The incidence of renal cell carcinoma continues to rise and is now nearly 51,000 cases annually in the United States, resulting in 13,000 deaths. The male-to-female ratio is 2:1. Incidence peaks between the ages of 50 and 70, although this malignancy may be diagnosed at any age. Many environmental factors have been investigated as possible contributing causes; the strongest association is with cigarette smoking (accounting for 20–30% of cases). Risk is also increased for patients who have acquired cystic disease of the kidney associated with end-stage renal disease and for those with tuberous sclerosis. Most cases are sporadic, although familial forms have been reported. One is associated with von Hippel-Lindau (VHL) syndrome, which predisposes to renal cell carcinomas, retinal hemangioma, hemangioblastoma of the spinal cord and cerebellum, and pheochromocytoma. Roughly 35% of individuals with VHL disease develop renal cell cancer. An increased incidence has also been reported for first-degree relatives.

### PATHOLOGY AND GENETICS

Renal cell neoplasia represents a heterogeneous group of tumors with distinct histopathologic, genetic, and clinical features ranging from benign to high-grade malignant ([Table 38-3](#)). They are classified on the basis of morphology and histology. Categories include clear cell carcinoma (60% of cases), papillary tumors (5–15%), chromophobic tumors (5–10%), oncocytomas (5–10%), and collecting or Bellini duct tumors (<1%). Papillary tumors tend to be bilateral and multifocal. Chromophobic tumors have a more indolent clinical course, and oncocytomas are considered benign neoplasms. In contrast, Bellini duct carcinomas, which are thought to arise from the collecting ducts within the renal medulla, are very rare but very aggressive. They tend to affect younger patients.

Clear cell tumors, the predominant histology, are found in >80% of patients who develop metastases. Clear cell tumors arise from the epithelial cells of the proximal tubules and usually show chromosome 3p deletions. Deletions of 3p21–26 (where the *VHL* gene maps) are identified in patients with familial as well as sporadic tumors. *VHL* encodes a tumor-suppressor protein that is involved in regulating the transcription of vascular endothelial growth factor (VEGF), platelet-derived growth factor (PDGF), and a number of other hypoxia-inducible proteins. Inactivation of *VHL* leads to overexpression of these agonists of the VEGF and PDGF receptors, which promote tumor angiogenesis

TABLE 38-3

CLASSIFICATION OF EPITHELIAL NEOPLASMS ARISING FROM THE KIDNEY			
CARCINOMA TYPE	GROWTH PATTERN	CELL OF ORIGIN	CYTOGENETICS
Clear cell	Acinar or sarcomatoid	Proximal tubule	3p–
Papillary	Papillary or sarcomatoid	Proximal tubule	+7, +17, –Y
Chromophobic	Solid, tubular, or sarcomatoid	Cortical collecting duct	Hypodiploid
Oncocytic	Tumor nests	Cortical collecting duct	Undetermined
Collecting duct	Papillary or sarcomatoid	Medullary collecting duct	Undetermined

and tumor growth. Agents that inhibit proangiogenic growth factor activity show antitumor effects.

## CLINICAL PRESENTATION

The presenting signs and symptoms include hematuria, abdominal pain, and a flank or abdominal mass. This classic triad occurs in 10–20% of patients. Other symptoms are fever, weight loss, anemia, and a varicocele (Table 38-4). The tumor can also be found incidentally on a radiograph. Widespread use of radiologic cross-sectional imaging procedures (CT, ultrasound, MRI) contributes to earlier detection, including incidental renal masses detected during evaluation for other medical conditions. The increasing number of incidentally discovered low-stage tumors has contributed to an improved 5-year survival for patients with renal cell carcinoma and increased use of nephron-sparing surgery (partial nephrectomy). A spectrum of paraneoplastic syndromes has been associated with these malignancies, including erythrocytosis, hypercalcemia, nonmetastatic hepatic dysfunction (Stauffer's syndrome), and acquired dysfibrinogenemia. Erythrocytosis is noted at presentation in only ~3% of patients. Anemia, a sign of advanced disease, is more common.

TABLE 38-4

SIGNS AND SYMPTOMS IN PATIENTS WITH RENAL CELL CANCER	
PRESENTING SIGN OR SYMPTOM	INCIDENCE, %
Classic triad: hematuria, flank pain, flank mass	10–20
Hematuria	40
Flank pain	40
Palpable mass	25
Weight loss	33
Anemia	33
Fever	20
Hypertension	20
Abnormal liver function	15
Hypercalcemia	5
Erythrocytosis	3
Neuromyopathy	3
Amyloidosis	2
Increased erythrocyte sedimentation rate	55

The standard evaluation of patients with suspected renal cell tumors includes a CT scan of the abdomen and pelvis, chest radiograph, urine analysis, and urine cytology. If metastatic disease is suspected from the chest radiograph, a CT of the chest is warranted. MRI is useful in evaluating the inferior vena cava in cases of suspected tumor involvement or invasion by thrombus. In clinical practice, any solid renal masses should be considered malignant until proven otherwise; a definitive diagnosis is required. If no metastases are demonstrated, surgery is indicated, even if the renal vein is invaded. The differential diagnosis of a renal mass includes cysts, benign neoplasms (adenoma, angiomyolipoma, oncocytoma), inflammatory lesions (pyelonephritis or abscesses), and other primary or metastatic cancers. Other malignancies that may involve the kidney include transitional cell carcinoma of the renal pelvis, sarcoma, lymphoma, and Wilms' tumor. All of these are less common causes of renal masses than is renal cell cancer.

## STAGING AND PROGNOSIS

Two staging systems used are the Robson classification and the American Joint Committee on Cancer (AJCC) staging system. According to the AJCC system, stage I tumors are <7 cm in greatest diameter and confined to the kidney, stage II tumors are ≥7 cm and confined to the kidney, stage III tumors extend through the renal capsule but are confined to Gerota's fascia (IIIa) or involve a single hilar lymph node (N1), and stage IV disease includes tumors that have invaded adjacent organs (excluding the adrenal gland) or involve multiple lymph nodes or distant metastases. The rate of 5-year survival varies by stage: >90% for stage I, 85% for stage II, 60% for stage III, and 10% for stage IV.



### Treatment:

### RENAL CELL CARCINOMA

**LOCALIZED TUMORS** The standard management for stage I or II tumors and selected cases of stage III disease is radical nephrectomy. This procedure involves en bloc removal of Gerota's fascia and its contents, including the kidney, the ipsilateral adrenal gland, and

adjacent hilar lymph nodes. The role of a regional lymphadenectomy is controversial. Extension into the renal vein or inferior vena cava (stage III disease) does not preclude resection even if cardiopulmonary bypass is required. If the tumor is resected, half of these patients have prolonged survival.

Nephron-sparing approaches via open or laparoscopic surgery may be appropriate for patients who have only one kidney, depending on the size and location of the lesion. A nephron-sparing approach can also be used for patients with bilateral tumors, accompanied by a radical nephrectomy on the opposite side. Partial nephrectomy techniques are being applied electively to resect small masses for patients with a normal contralateral kidney. Adjuvant therapy following this surgery does not improve outcome, even in cases with a poor prognosis.

**ADVANCED DISEASE** Surgery has a limited role for patients with metastatic disease. However, long-term survival may occur in patients who relapse after nephrectomy in a solitary site that can be removed. One indication for nephrectomy with metastases at initial presentation is to alleviate pain or hemorrhage of a primary tumor. Also, a cytoreductive nephrectomy before systemic treatment improves survival for carefully selected patients with stage IV tumors.

Metastatic renal cell carcinoma is highly refractory to chemotherapy and only infrequently responsive to cytokine therapy with IL-2 or IFN- $\alpha$ . IFN- $\alpha$  and IL-2 produce regressions in 10–20% of patients, but on occasion these responses are durable. IL-2 was approved on the observation of durable complete remission in a small proportion of cases.

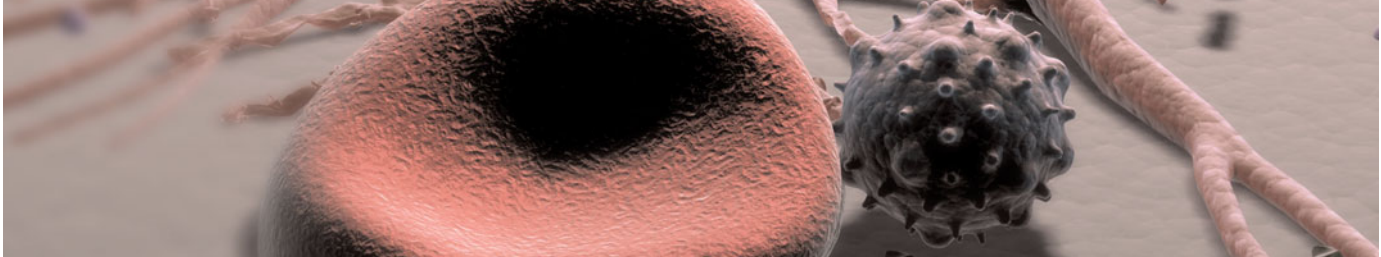
The situation changed dramatically when two large-scale randomized trials established a role for antiangiogenic therapy in this disease as predicted by the genetic studies. These trials separately evaluated two orally administered antiangiogenic agents, sorafenib and sunitinib, that inhibited receptor tyrosine kinase signaling through the VEGF and PDGF receptors. Both showed efficacy as second-line treatment following progression during cytokine treatment, resulting in approval by regulatory authorities for the treatment of advanced renal cell carcinoma. A randomized phase 3 trial comparing sunitinib to IFN- $\alpha$  showed superior efficacy for sunitinib with an acceptable safety profile. The trial resulted in a change in the standard first-line treatment from IFN to

sunitinib. Sunitinib is usually given orally at a dose of 50 mg/d for 4 weeks out of 6. Diarrhea is the main toxicity. Sorafenib is usually given orally at a dose of 400 mg bid. In addition to diarrhea, toxicities include rash, fatigue, and hand-foot syndrome. Temsirolimus, a mammalian target of rapamycin (mTOR) inhibitor, also has activity in previously treated patients. The usual dosage is 25 mg IV weekly.

The prognosis of metastatic renal cell carcinoma is variable. In one analysis, no prior nephrectomy, a KPS <80, low hemoglobin, high corrected calcium, and abnormal lactate dehydrogenase were poor prognostic factors. Patients with zero, one or two, and three or more factors had a median survival of 24, 12, and 5 months, respectively. These tumors may follow an unpredictable and protracted clinical course. It may be best to document progression before considering systemic treatment.

## FURTHER READINGS

- ATKINS MB et al: Treatment selection for patients with metastatic renal cell carcinoma. *Cancer* 115 (Suppl 10):2327, 2009
- BISCHOFF CJ, CLARK PE: Bladder cancer. *Curr Opin Oncol* 21:272, 2009
- BLACK PC et al: Molecular markers of urothelial cancer and their use in the monitoring of superficial urothelial cancer. *J Clin Oncol* 24:5528, 2006
- BRASSELL SA, KAMAT AM: Contemporary intravesical treatment options for urothelial carcinoma of the bladder. *J Natl Compr Canc Netw* 4:1027, 2006
- COHEN HT, MCGOVERN FJ: Renal-cell carcinoma. *N Engl J Med* 353:2477, 2005
- HUANG WC et al: Chronic kidney disease after nephrectomy in patients with renal cortical tumours: A retrospective cohort study. *Lancet Oncol* 7:735, 2006
- KAUFMAN DS et al: Bladder cancer. *Lancet* 374:239, 2009
- MITRA AP et al: Molecular pathways in invasive bladder cancer: New insights into mechanisms, progression, and target identification. *J Clin Oncol* 24:5552, 2006
- MOTZER RJ et al: Sunitinib in patients with metastatic renal cell carcinoma. *JAMA* 295:2516, 2006
- NELSON EC et al: Renal cell carcinoma: Current status and emerging therapies. *Cancer Treat Rev* 33:299, 2007
- RINI BI: Metastatic renal cell carcinoma: Many treatment options, one patient. *J Clin Oncol* 27:3225, 2009
- SUGANO K, KAKIZOE T: Genetic alterations in bladder cancer and their clinical applications in molecular tumor staging. *Nature Clin Pract* 3:642, 2006
- WINQUIST E et al: Neoadjuvant chemotherapy for transitional cell carcinoma of the bladder: A systematic review and meta-analysis. *J Urol* 171:561, 2004



## CHAPTER 39

# BENIGN AND MALIGNANT DISEASES OF THE PROSTATE

Howard I. Scher

■ Anatomy and Pathology . . . . .	511
■ Prostate Cancer . . . . .	512
Epidemiology . . . . .	512
Diagnosis and Treatment by Clinical State . . . . .	512
No Cancer Diagnosis . . . . .	513
■ Benign Disease . . . . .	522
Symptoms . . . . .	522
Diagnostic Procedures and Treatment . . . . .	522
■ Further Readings . . . . .	523

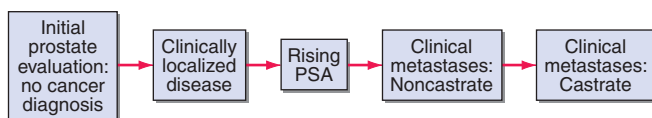
Benign and malignant changes in the prostate increase with age. Autopsies of men in the eighth decade of life show hyperplastic changes in >90% and malignant changes in >70% of individuals. The high prevalence of these diseases among the elderly, who often have competing causes of morbidity and mortality, mandates a risk-adapted approach to diagnosis and treatment. This can be achieved by considering these diseases as a series of states. Each state represents a distinct clinical milestone for which intervention(s) may be recommended based on current symptoms or the risk of developing symptoms or death from disease within a given time frame (Fig. 39-1). For benign proliferative disorders, symptoms of urinary frequency, infection, and potential for obstruction are weighed against the side effects and complications of medical or surgical therapy. For prostate malignancies, the risks of developing the disease, symptoms, or death from cancer are balanced

against the morbidities of the interventions recommended and preexisting comorbid conditions.

### ANATOMY AND PATHOLOGY

The prostate is located in the pelvis and surrounded by the rectum, the bladder, the periprostatic and dorsal vein complexes that are responsible for erectile function, and the urinary sphincter that is responsible for passive urinary control. The prostate is composed of branching tubuloalveolar glands arranged in lobules and surrounded by a stroma. The acinal unit includes an epithelial compartment made up of epithelial, basal, and neuroendocrine cells and a stromal compartment that includes fibroblasts and smooth-muscle cells. The compartments are separated by a basement membrane. Prostate-specific antigen (PSA) and acid phosphatase are produced in the epithelial cells. Both prostate epithelial cells and stromal cells express androgen receptors and depend on androgens for growth. Testosterone, the major circulating androgen, is converted by the enzyme 5 $\alpha$ -reductase to dihydrotestosterone in the gland.

The periurethral portion of the gland increases in size during puberty and after the age of 55 due to the growth of nonmalignant cells in the transition zone of the prostate



**FIGURE 39-1**  
**Clinical states of prostate cancer.** PSA, prostate-specific antigen.



## PROSTATE CANCER

In 2007 in the United States, ~218,890 prostate cancer cases were diagnosed, and 27,050 men died from prostate cancer. The absolute number of prostate cancer deaths has decreased in the past 5 years; some have attributed this to the widespread use of PSA-based detection strategies. However, screening has not been shown to improve survival in prospective randomized trials. The paradox of management is that although the disease remains the second leading cause of cancer deaths in men, only 1 man in 8 with prostate cancer will die of his disease.

### EPIDEMIOLOGY



Epidemiologic studies show that the risk of being diagnosed with prostate cancer increases by a factor of 2 if one first-degree relative is affected and by 4 if two or more are affected. Current estimates are that 40% of early-onset and 5–10% of all prostate cancers are hereditary. Prostate cancer affects ethnic groups differently. Matched for age, African American males compared to white males have both a greater number of prostatic intraepithelial neoplasia (PIN) lesions, which are precursors to cancer, and larger tumors, possibly related to the higher levels of testosterone seen in African American males. PIN, the precursor of cancer, is typically multifocal and highly unstable. Polymorphic variants of the androgen receptor gene, the cytochrome P450 C17 gene, and the steroid 5 $\alpha$ -reductase type II (*SRD5A2*) gene have also been implicated in the variations in incidence.

The incidence of autopsy-detected cancers is similar around the world, whereas the incidence of clinical disease varies. Thus environmental factors may play a role. High consumption of dietary fats, such as  $\alpha$ -linoleic acid or the polycyclic aromatic hydrocarbons that form when red meats are cooked, is believed to increase risk. Similar to breast cancer in Asian women, the risk of prostate cancer in Asian men increases when they move to Western environments. Protective factors include consumption of the isoflavonoid genistein (which inhibits 5 $\alpha$ -reductase), cruciferous vegetables that contain the isothiocyanate sulforaphane, retinoids such as lycopene (in tomatoes), and inhibitors of cholesterol biosynthesis (e.g., statin drugs). The antioxidants  $\alpha$ -tocopherol (vitamin E) and selenium may also reduce risk.

The development of a prostate cancer is a multistep process. One early change is hypermethylation of the GSTP1 gene promoter, which leads to loss of function

of a gene that detoxifies carcinogens. A role for inflammation has been suggested based on the finding that many prostate cancers occur adjacent to a lesion termed *PIA* (*proliferative-inflammatory atrophy*). This also suggests a role for oxidative damage.

### DIAGNOSIS AND TREATMENT BY CLINICAL STATE

The disease continuum—from the appearance of a preneoplastic and invasive lesion localized to the prostate, to a metastatic lesion that results in symptoms and, ultimately, mortality from prostate cancer—can span decades. Management at all points is centered on competing risks that are defined by considering the disease as a series of clinical states (Fig. 39-1). The states are defined operationally, on the basis of whether or not a cancer diagnosis has been established and, for those already diagnosed, whether or not metastases are detectable on imaging studies and the measured level of testosterone in the blood. With this approach, an individual resides in only one state and remains in that state until he has progressed. At each assessment, the decision to offer treatment and the specific form of treatment is based on the risk posed by the cancer, relative to competing causes of mortality that may be present in that individual. It follows that the more advanced the disease, the greater the need for treatment. For those without a cancer diagnosis, the decision to undergo testing to detect a cancer is based on the probability that a clinically significant cancer may be present. For those with a prostate cancer diagnosis, the clinical state model considers the probability of developing symptoms or dying from disease. Thus a patient with localized prostate cancer who has had all cancer removed surgically remains in the state of localized disease as long as the PSA remains undetectable. The time within a state becomes a measure of the efficacy of an intervention, although the effect may not be assessable for years. Because many men with active cancer are not at risk for developing metastases, symptoms, or death, the states model allows a distinction between *cure*—the elimination of all cancer cells, the primary therapeutic objective when treating most cancers—and *cancer control*, in which the tempo of the illness is altered and symptoms controlled until the patient dies of other causes. These can be equivalent therapeutically from a patient standpoint if the patient has not experienced symptoms of the disease or the treatment needed to control it. Even when a recurrence is documented, immediate therapy is not always necessary. Rather, as at the time of diagnosis, the need for intervention is based on the tempo of the illness as it unfolds in the individual, relative to the risk-to-benefit ratio of the therapy being considered.

## NO CANCER DIAGNOSIS

### Prevention

Several agents are under investigation for their potential to reduce the risk of clinically significant prostate cancer. Finasteride, a 5 $\alpha$ -reductase inhibitor, has been tested in men ages  $\geq 55$  years in the Prostate Cancer Prevention Trial, a double-blind, randomized multicenter trial. The prostate cancer detection rate was 18.4% (803 of 4364) in the finasteride group and 24.4% (1147 of 4692) in the placebo group. Early concerns that the cancers detected in the finasteride group were high-grade [37% (280 of 757 cancers) vs 22% (237 of 1068 cancers) for the placebo group] have been shown to be an artifact of the reduced volume of the malignant epithelial cells in finasteride-treated patients. No effect on survival was detected. Vitamin E and selenium are also being tested as preventive agents (the SELECT study).

### Physical Examination

The need to pursue a diagnosis of prostate cancer is based on symptoms, an abnormal DRE, or an elevated serum PSA. The urologic history should focus on symptoms of outlet obstruction, continence, potency, or change in ejaculatory pattern.

The DRE focuses on prostate size and consistency and abnormalities within or beyond the gland. Many cancers occur in the peripheral zone and can be palpated on DRE. Carcinomas are characteristically hard, nodular, and irregular, whereas induration may be due to benign prostatic hypertrophy (BPH) or to calculi or tumor. Overall, 20–25% of men with an abnormal DRE have cancer.

### Prostate-Specific Antigen

PSA is a kallikrein-like serine protease that causes liquefaction of seminal coagulum. It is produced by both nonmalignant and malignant epithelial cells. PSA is prostate-specific, not prostate cancer-specific, and serum PSA increases may occur from prostatitis, BPH, and prostate cancer. The performance of a prostate biopsy can increase PSA levels up to tenfold for 8–10 weeks. The serum PSA level is not affected by DRE. PSA circulates in the blood as an inactive complex with the protease inhibitors  $\alpha_1$ -antichymotrypsin and  $\beta_2$ -macroglobulin, and it has an estimated half-life in serum of 2–3 days. Levels should be undetectable if the prostate has been removed. Immunohistochemical staining for PSA can be used to establish a prostate cancer diagnosis.

PSA testing was approved in 1994 for early detection of prostate cancer, but there is controversy on its use. The American Cancer Society recommends that physicians offer PSA testing and a DRE on an annual basis

for men >50 years of age with an anticipated survival of >10 years; this includes men up to age 76 years. For African Americans and men with a family history of prostate cancer, testing is advised to begin at age 45. The American Urologic Association recommendations are similar, with a proviso that the risks and benefits of the performance of these tests are not defined. The National Comprehensive Cancer Network advises testing at age 40, tailoring additional testing to the age-specific median. The American College of Physicians recommends that physicians “describe the potential benefits and known harms of screening” and to “individualize the decision to screen.” PSA values may fluctuate for no apparent reason; thus an isolated abnormal value should be confirmed before proceeding with further testing.

The PSA criteria used to recommend a diagnostic prostate biopsy have evolved over time. The goal is to increase the sensitivity of the test for younger men more likely to die of the disease and to reduce the frequency of detecting cancers of low malignant potential in elderly men more likely to die of other causes. Age-specific reference ranges reduce the upper limit of normal for younger men and increase it for older men. Different thresholds alter the sensitivity and specificity of detection. The threshold for performance of a biopsy was 4.0 ng/mL, which has been reduced to 2.6 ng/mL for men <60 years of age by many groups based on the finding that nearly half of the men with PSAs who reached this level increased to 4 within a relatively short (4-year) time frame, and that, once diagnosed, nearly a third had spread beyond the confines of the gland. Most PSA is complexed to  $\alpha_1$ -chymotrypsin (ACT); only a small percentage is “free.” To improve diagnostic accuracy for men with a PSA between 4 and 10, the risk of cancer is <10% if the free PSA is >25% but as high as 56% for those with a free PSA <10%. PSA density measurements were developed to correct for the contribution of BPH to the total PSA level. PSA density is calculated by dividing the serum PSA by the prostate weight estimated from transrectal ultrasound (TRUS). Values <0.10 ng/mL per cm<sup>3</sup> are consistent with BPH; those >0.15 suggest cancer. *PSA velocity* is the rate of change in PSA levels over time and is expressed most commonly as the PSA doubling time. It is particularly useful for men with seemingly normal values that are rising. For men with a PSA >4, rates of rise >0.75 ng/mL per year suggest cancer, whereas for those with lower PSA levels, rates >0.5 ng/mL per year should be used to advise a biopsy. As an example, an increase from 2.5 to 3.2 in a 1-year period would warrant further testing. Free and complexed PSA measurements are used when levels are between 4 and 10 ng/mL to decide whether a biopsy is needed. The level of free PSA is lower in men with cancer. The ratios of free to total, complexed to total, and free to complexed PSA have also been used. In one series,

514 specificity improved by 20% by defining normal ranges as free/total >0.15, complexed/total <0.70, and free/complexed >0.25.

PSA-based detection strategies have changed the clinical spectrum of the disease. Now, 95–99% of newly diagnosed cancers are clinically localized, 40% are not palpable, and of these, 70% are pathologically organ-confined. The downside of widespread PSA screening is the detection and treatment of cancers with such a low malignant potential that they would not have shortened survival or produced symptoms during the patient's lifetime. The side effects of treatment, including impotence, incontinence, and bowel dysfunction, are unacceptable for these patients. Formal clinical trials to assess the value of screening on prostate cancer morbidity and mortality are ongoing. Until the results of these studies are available, men are advised to make an informed decision about whether to undergo testing.

A diagnostic algorithm based on the DRE and PSA findings is illustrated in Fig. 39-2. In general, a biopsy is recommended if the DRE or PSA is abnormal. Twenty-five percent of men with a PSA >4 ng/mL and an abnormal DRE have cancer, as do 17% of men with a PSA of 2.5–4.0 ng/mL and normal DRE.

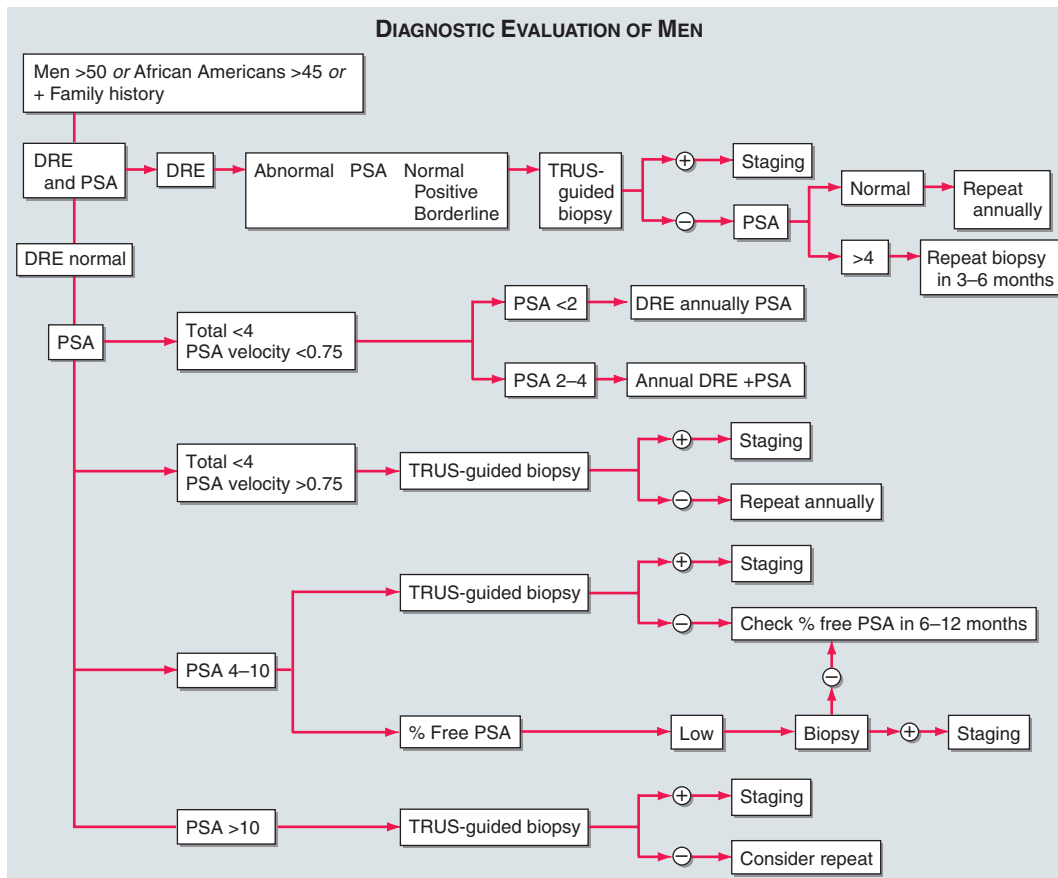
## Prostate Biopsy

A diagnosis of cancer is established by a TRUS-guided needle biopsy. Direct visualization by ultrasound or MRI assures that all areas of the gland are sampled. A minimum of six separate cores, three from the right and three from the left, is advised, as is a separate biopsy of the transition zone if clinically indicated. More commonly, 12–14 cores are advised to increase the diagnostic yield. Patients with prostatitis should have a course of antibiotics before biopsy. Men with an abnormal PSA and negative biopsy are advised to undergo a repeat biopsy.

Each core of the biopsy is examined for the presence of cancer, and the amount of cancer is quantified based on the length of the tumor within the core and the percentage of the core involved.

## Pathology

The noninvasive proliferation of epithelial cells within ducts is termed *prostatic intraepithelial neoplasia*. PIN is a precursor of cancer, but not all PIN lesions develop into invasive cancers. Of the cancers identified, >95% are adenocarcinomas; the remainder are squamous or transitional cell tumors or, rarely, carcinosarcomas. Metastases



**FIGURE 39-2** Algorithm for diagnostic evaluation of men based on digital rectal examination and prostate-specific antigen levels.

to the prostate are rare, but in some cases colon cancers or transitional cell tumors of the bladder invade the gland by direct extension. When prostate cancer is diagnosed, a measure of histologic aggressiveness is assigned using the *Gleason grading system*, in which the dominant and secondary glandular histologic patterns are scored from 1 (well-differentiated) to 5 (undifferentiated) and summed to give a total score of 2–10 for each tumor. The most poorly differentiated area of tumor (i.e., the area with the highest histologic grade) often determines biologic behavior. The presence or absence of perineural invasion and extracapsular spread are also recorded.

### Prostate Cancer Staging

The TNM staging system includes categories for cancers that are palpable on DRE, those identified solely on the basis of an abnormal PSA (T1c), those that are palpable but clinically confined to the gland (T2), and those that have extended outside the gland (T3 and T4) (Table 39-1). DRE alone is inaccurate with respect to the extent of the disease within the gland, the presence or absence of capsular invasion, involvement of seminal vesicles, and extension of disease to lymph nodes. Because of the inadequacy of DRE for staging, the staging system was modified to include the results of imaging studies. Unfortunately, no single test has proven to indicate accurately

the stage or the presence of organ-confined disease, seminal vesicle involvement, or lymph node spread.

TRUS is the imaging technique most frequently used to assess the primary tumor, but its chief use is directing prostate biopsies, not staging. No TRUS finding consistently indicates cancer with certainty. CT lacks sensitivity and specificity to detect extraprostatic extension and is inferior to MRI in visualization of lymph nodes. In general, MRI performed with an endorectal coil is superior to CT to detect cancer in the prostate and to assess local disease extent. T1-weighted images produce a high signal in the periprostatic fat, periprostatic venous plexus, perivesicular tissues, lymph nodes, and bone marrow. T2-weighted images demonstrate the internal architecture of the prostate and seminal vesicles. Most cancers have a low signal, whereas the normal peripheral zone has a high signal, although the technique lacks sensitivity and specificity. MRI is also useful for the planning of surgery and radiation therapy.

Radionuclide bone scans are used to evaluate spread to osseous sites. This test is sensitive but relatively non-specific because areas of increased uptake are not always related to metastatic disease. Healing fractures, arthritis, Paget's disease, and other conditions will also cause abnormal uptake. True-positive bone scans are rare if the PSA is <8 ng/mL and uncommon when the PSA is <10 ng/mL unless the tumor is high-grade.

TABLE 39-1

#### COMPARISON OF CLINICAL STAGE BY THE TNM CLASSIFICATION SYSTEM AND THE WHITMORE-JEWETT STAGING SYSTEM

TNM STAGE	DESCRIPTION	WHITMORE-JEWETT STAGE	DESCRIPTION
T1a	Nonpalpable, with 5% or less of resected tissue with cancer	A1	Well differentiated tumor on few chips from one lobe
T1b	Nonpalpable, with >5% of resected tissue with cancer	A2	Involvement more diffuse
T1c	Nonpalpable, detected due to elevated serum PSA		
T2a	Palpable, half of one lobe or less	BIN	Palpable, < one lobe, surrounded by normal tissue
T2b	Palpable, > half of one lobe but not both lobes	B1	Palpable, < one lobe
T2c	Palpable, involves both lobes	B2	Palpable, one entire lobe or both lobes
T3a	Palpable, unilateral extracapsular extension	C1	Palpable, outside capsule, not into seminal vesicles
T3b	Palpable, bilateral extracapsular extension		
T3c	Tumor invades seminal vesicle(s)	C2	Palpable, seminal vesicle involved
M1	Distant metastases	D	Metastatic disease

**Source:** Adapted from FF Schroder et al: TNM classification of prostate cancer. *Prostate (Suppl)* 4:129, 1992; and American Joint Committee on Cancer, 1992.

## Rx Treatment: PROSTATE CANCER

**CLINICALLY LOCALIZED DISEASE** Localized prostate cancers are those that appear to be non-metastatic after staging studies are performed. Patients with localized disease are managed by radical surgery, radiation therapy, or active surveillance. Choice of therapy requires the consideration of several factors: the presence of symptoms, the probability that the untreated tumor will adversely affect the patient during his lifetime and thus require treatment, and the probability that the tumor can be cured by single-modality therapy directed at the prostate or requires both local and systemic therapy to achieve cure. Because most of the tumors detected are deemed clinically significant, most men undergo treatment.

Data from the literature do not provide clear evidence for the superiority of any one treatment. Comparison of outcomes of various forms of therapy is limited by the lack of prospective trials, referral bias, and differences in the outcomes used. The primary outcomes are cancer control and treatment-related morbidities. Definitions of cancer control, however, vary by modality. Often, PSA relapse-free survival is used because an effect on metastatic progression or survival may not be apparent for years. After radical surgery to remove all prostate tissue, PSA should become undetectable in the blood within 4 weeks, based on the PSA half-life in the blood of 3 days. If PSA remains detectable, the patient is considered to have persistent disease. After radiation therapy, in contrast, PSA does not become undetectable because the remaining nonmalignant elements of the gland continue to produce PSA even if all cancer cells have been eliminated. Similarly, cancer control is not well defined for a patient managed by active surveillance because PSA levels will continue to rise in the absence of therapy. Other outcomes are time to objective progression (local or systemic) and cancer-specific and overall survival; however, these outcomes may take years to assess.

The more advanced the disease, the lower the probability of local control and the higher the probability of systemic relapse. More important is that within the categories of T1, T2, and T3 disease are tumors with a range of prognoses. Some T3 tumors are curable with therapy directed solely at the prostate, and some T1 lesions have a high probability of systemic relapse that requires the integration of local and systemic therapy to achieve cure. For T1c tumors in particular, stage alone is inadequate to predict outcome and select treatment; other factors must be considered. Many groups have developed prognostic models that use a combination of the initial T stage, Gleason score, and baseline PSA. Some use discrete cut points (PSA <10 or  $\geq$ 10; Gleason score of  $\leq$ 6, 7, or  $\geq$ 8); others are nomograms that use

PSA and Gleason score as continuous variables. These algorithms can be used to predict disease extent (organ-confined vs non-organ-confined, node-negative or -positive) and the probability of success of treatment using a PSA-based definition specific to the local therapy under consideration. Specific nomograms have been developed for radical prostatectomy, external beam radiation therapy, and brachytherapy (seed implantation). These are being refined continually to incorporate other clinical parameters and biologic determinants. Surgical technique, radiation therapy delivery, and criteria for active surveillance continue to be refined and improved; the year of treatment affects outcomes independent of other factors. The improvements make treatment decisions a dynamic process.

The frequency of adverse events for the different treatment modalities varies with the modality used and the experience of the treating team. For example, following radical prostatectomy, incontinence rates range from 2–47% and impotence rates range from 25–89%. Part of the variability relates to how the complication is defined and whether the patient or physician is reporting the event. The time of the assessment is also important. After surgery, impotence is immediate but may reverse over time, whereas with radiation therapy impotence is not immediate but may develop over time. Of greatest concern to patients are the effects on continence, sexual potency, and bowel function.

**Radical Prostatectomy** The goal of radical prostatectomy is to excise the cancer completely with a clear margin, to maintain continence by preserving the external sphincter, and to preserve potency by preserving the autonomic nerves in the neurovascular bundle. Radical prostatectomy is advised for patients with a life expectancy of >10 years and is performed using a retropubic, perineal, or laparoscopic approach. Outcomes can be predicted using postoperative nomograms that consider pretreatment factors and the pathologic findings at surgery. PSA failure is defined as a value above 0.2 or 0.4 ng/mL, although the exact definition varies among series.

There is controversy over the definition of what constitutes “high risk” based on a predicted probability of success or failure. In these situations, nomograms and predictive models can only go so far. Exactly what probability of success or failure would lead a physician to recommend and a patient to seek alternative approaches is controversial. For example, it may be appropriate to recommend radical surgery for a younger patient with a low probability of cure.

Prostatectomy techniques continue to improve as the ability to determine whether the tumor is localized to the gland improves based on different biopsy algorithms and with imaging. The result is better case

selection and better surgical planning, which in turn have led to more rapid recovery and higher rates of continence and potency. Factors associated with incontinence include older age and shorter urethra length. The specific surgical technique, open versus laparoscopic versus robotic, as well as the skill and experience of the surgeon, are also factors for the preservation of neurovascular bundles and development of an anastomotic stricture. Surgical experience is also a factor. In a series treated at an academic center, 6% of patients had mild stress urinary incontinence (SUI) (requiring 1 pad/day), 2% moderate SUI (>1 pad/day), and 0.3% severe SUI (requiring an artificial urinary sphincter). At 1 year, 92% were completely continent. In contrast, the results in a Medicare population treated at multiple centers showed that at 3, 12, and 24 months following surgery, 58%, 35%, and 42% (respectively) wore pads in their underwear, and 24%, 11%, and 15% reported “a lot” of urine leakage.

Factors associated with recovery of erectile function include younger age, quality of erections before surgery, and the absence of damage to the neurovascular bundles. Erectile function returns in a median of 4–6 months if both bundles are preserved. Potency is reduced by half if at least one nerve bundle is sacrificed. In cases where cancer control requires the removal of both bundles, sural nerve grafts are being explored. Overall, with the availability of drugs such as sildenafil, intraurethral inserts of alprostadil, and intracavernosal injections of vasodilators, many patients recover satisfactory sexual function.

Neoadjuvant hormonal therapy has been explored in an attempt to improve the outcomes of surgery for high-risk patients. The results of several large trials testing 3 or 8 months of androgen depletion before surgery showed that serum PSA levels decreased by 96%, prostate volumes decreased by 34%, and margin positivity rates decreased from 41% to 17%. Unfortunately, hormones did not produce an improvement in PSA relapse-free survival. Thus neoadjuvant hormonal therapy is not recommended.

**Radiation Therapy** Radiation therapy is given by external beam, by radioactive sources implanted into the gland, or by a combination.

**External Beam Radiation Therapy** Contemporary external beam radiation techniques now use three-dimensional conformal treatment plans with intensity-modulated radiation therapy (IMRT) to maximize the dose to the prostate and to minimize the exposure of the surrounding normal structures. The addition of IMRT has permitted further shaping of the dose, allowing the delivery of still higher doses to the prostate and a further reduction in normal tissue exposure. These

advances have enabled the safe administration of doses >80 Gy, higher local control rates, and fewer side effects.

Cancer control after radiation therapy has been defined by various criteria, including a decline in PSA to <0.5 or 1 ng/mL, “nonrising” PSA values, and a negative biopsy of the prostate 2 years after completion of treatment. PSA relapse is defined as three consecutive rising PSA values from the nadir value, with the time to failure as a rise by 2 ng/mL or greater above the posttreatment nadir value.

Radiation dose is important. A PSA nadir of <1.0 ng/mL was observed in 90% of patients receiving 75.6 or 81.0 Gy versus 76% and 56% of those receiving 70.2 Gy and 64.8 Gy, respectively. The positive biopsy rates at 2.5 years were 4% for those treated with 81 Gy versus 27% and 36% for those receiving 75.6 or 70.2 Gy. The frequency of rectal complications relates directly to the volume of the anterior rectal wall receiving full-dose treatment.

Overall, radiation therapy is associated with a higher frequency of bowel complications (mainly diarrhea and proctitis) than surgery. Grade 3 rectal or urinary toxicities were seen in 2.1% of patients who received a median dose of 75.6 Gy. Grade 3 urethral strictures requiring dilatation developed in 1% of cases, all of whom had undergone a transurethral resection of the prostate (TURP). Pooled data show that the frequency of grade 3 and 4 toxicities is 6.9 and 3.5%, respectively, for patients who received >70 Gy. The frequency of erectile dysfunction is related to the quality of erections pretreatment, the dose administered, and the time of assessment. Postradiation erectile dysfunction is related to a disruption of the vascular supply and not the nerve fibers.

Neoadjuvant hormone therapy has also been studied in combination with radiation therapy. The aim is to decrease the size of the prostate and, consequently, to reduce the exposure of normal tissues to full-dose radiation, to increase local control rates, and to decrease the rate of systemic failure. Short-term hormone therapy can reduce toxicities and improve local control rates, but long-term treatment (2–3 years) is needed to prolong the time to PSA failure and lower the risk of metastatic disease. The impact on survival has been less clear.

**Brachytherapy** Brachytherapy is the direct implantation of radioactive sources into the prostate. It is based on the principle that the deposition of radiation energy in tissues decreases as a function of the square of the distance from the source (Chap. 27). The goal is to deliver intensive irradiation to the prostate, minimizing the exposure of the surrounding tissues. The current standard technique achieves a more homogeneous dose distribution by placing seeds according to a customized template based on CT and ultrasonographic assessment of the tumor and computer-optimized dosimetry. The

implantation is performed transperineally, without an open procedure, with real-time imaging.

The improvements in brachytherapy techniques have resulted in fewer complications and a marked reduction in local failure rates. In a series of 197 patients followed for a median of 3 years, 5-year actuarial PSA relapse-free survival for patients with pretherapy PSA levels of 0–4, 4–10, and >10 ng/mL were 98%, 90%, and 89%, respectively. In a separate report of 201 patients who underwent posttreatment biopsies, 80% were negative, 17% were indeterminate, and 3% were positive. The results did not change with longer follow-up. Nevertheless, many physicians feel that implantation is best reserved for patients with good or intermediate prognostic features.

Brachytherapy is well tolerated, although most patients experience urinary frequency and urgency that can persist for several months. Incontinence has been seen in 2–4% of cases. Higher complication rates are observed in patients who have undergone a prior TURP or who have obstructive symptoms at baseline. Proctitis has been reported in <2% of patients.

**Active Surveillance** Active surveillance, described previously as *watchful waiting*, or *deferred therapy*, is a policy of monitoring the illness at fixed intervals with DREs, PSA measurements, and repeat biopsies of the prostate as indicated, but with no therapeutic intervention(s) until the tumor progresses. Progression can be based on PSA changes, local tumor growth, the development of symptoms, or metastatic disease. The practice evolved from studies of predominantly elderly men with well-differentiated tumors who demonstrated no clinically significant progression for protracted periods, during which a significant proportion died of intercurrent disease. In a structured literature review of patients treated by radical surgery, external beam radiation, or a deferred approach, the 10-year survival rates were 93% for radical prostatectomy, 74% for external beam radiation, and 84% for deferred treatment. Arguing against active surveillance are the results of a Swedish randomized trial of radical prostatectomy versus active surveillance. With a median follow-up of 6.2 years, men treated by radical surgery had a lower risk of prostate cancer death relative to active surveillance patients (4.6% vs 8.9%) and a lower risk of metastatic progression (hazard ratio: 0.63).

Case selection is critical, and the criteria to select men who can safely choose active surveillance are under intense study. In a prostatectomy series, it was estimated that 10–15% of patients had “insignificant” cancers. Given the multifocality of the disease, a concern is the limited ability to predict pathologic findings on the basis of a needle biopsy, even when multiple cores are obtained. Nomograms to help predict which

patients can safely be managed by active surveillance have been developed, and as their predictive accuracy improves, it can be anticipated that more patients will be candidates.

**RISING PSA** This state consists of patients in whom the sole manifestation of disease is a rising PSA after surgery and/or radiation therapy. By definition, patients have no evidence of disease on scan. For these patients the central issue is whether the rise in PSA results from persistent disease in the primary site, systemic disease, or both. In theory, disease in the primary site may still be curable by additional local treatment; external beam radiation for patients who had undergone surgery, prostatectomy for patients who had undergone radiation therapy.

The decision to recommend radiation therapy after prostatectomy is often made on the basis of the pathologic findings at surgery because imaging studies such as CT and bone scan are typically uninformative. Some recommend a ProstaScint scan: imaging with a radiolabeled antibody to prostate-specific membrane antigen (PSMA), which is highly expressed on prostate epithelial cells, to help with this distinction. Antibody localization to the prostatic fossa suggests local recurrence; localization to extrapelvic sites predicts failure of radiation therapy. Others recommend that a biopsy of the urethrovesical anastomosis be obtained before considering radiation. Factors that predict for response to salvage radiation therapy are a positive surgical margin, lower Gleason grade, long interval from surgery to PSA failure, slow PSA doubling time, and low (<0.5–1.0 ng/mL) PSA value at the time of radiation treatment. Radiation therapy is generally not recommended if the PSA was persistently elevated after surgery, which usually indicates that the disease had spread outside of the area of the prostate bed and is unlikely to be controlled with radiation therapy.

For patients with a rising PSA after radiation therapy, salvage prostatectomy can be considered if the disease was “curable” at the outset, if persistent disease has been documented by a biopsy of the prostate, and if no metastatic disease is seen on imaging studies. Unfortunately, case selection is poorly defined in most series, and morbidities are significant. As currently performed, virtually all patients are impotent after salvage radical prostatectomy, and ~45% have either total urinary incontinence or stress incontinence. Major bleeding, bladder neck contractures, and rectal injury are not uncommon.

In many cases, the rise in PSA after surgery or radiation therapy indicates subclinical metastatic disease. In these cases, the need for treatment depends, in part, on the estimated probability that the patient will show evidence of metastatic disease on a scan and in what

time frame. That immediate therapy is not always required was shown in a series where patients received no systemic therapy until metastatic disease was documented. Overall, the median time to metastatic progression was 8 years, and 63% of the patients with rising PSA values remained free of metastases at 5 years. Factors associated with progression included the Gleason grade of the primary tumor, time to recurrence, and PSA doubling times. For those with Gleason grade  $\geq 8$  tumors, the probability of metastatic progression was 37%, 51%, and 71% at 3, 5, and 7 years, respectively. If the time to recurrence was  $< 2$  years and PSA doubling time was long ( $> 10$  months), the proportion with metastatic disease at the same time intervals was 23%, 32%, and 53%, versus 47%, 69%, and 79% if the doubling time was short ( $< 10$  months). A difficulty with predicting the course of disease in the rising PSA state is that most patients receive some form of therapy before the development of metastases. Nevertheless, predictive models continue to be refined. PSA doubling times are prognostic for survival. In one series, all patients who succumbed to disease had PSA doubling times of  $\leq 3$  months. Most physicians advise treatment when PSA doubling times are  $\leq 12$  months.

### METASTATIC DISEASE: NONCASTRATE

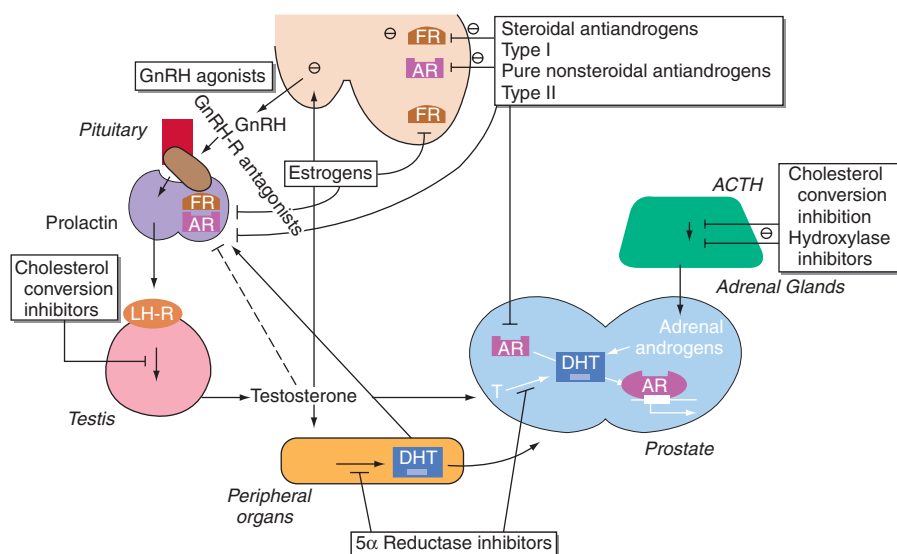
*Metastatic disease noncastrate* refers to patients with metastases visible on an imaging study and noncastrate levels of testosterone. The patient may be newly diagnosed or have a recurrence after treatment for localized disease. Symptoms of metastatic disease include pain from osseous spread, although many patients are asymptomatic despite extensive spread. Less common are symptoms related to marrow compromise (myelophthisis), coagulopathy, or spinal cord compression.

Standard treatment for noncastrate metastatic disease is to deplete androgens by medical or surgical

means. Over 90% of male hormones originate in the testes;  $< 10\%$  are synthesized in the adrenal gland. Surgical orchiectomy is the "gold standard" approach but is least acceptable to patients. Medical therapies can be divided into agents that lower testosterone levels and antiandrogens that bind to the androgen receptor but do not signal (Fig. 39-3).

**Testosterone-Lowering Agents** Medical therapies that lower testosterone levels include the gonadotropin-releasing hormone (GnRH) analogues, estrogens, and progestational agents. Estrogens such as diethylstilbestrol have fallen out of favor due to the risk of vascular complications such as fluid retention, phlebitis, emboli, and stroke. GnRH analogues (leuprolide acetate and goserelin acetate) initially produce a rise in luteinizing hormone and follicle-stimulating hormone followed by a downregulation of receptors in the pituitary gland, which effects a chemical castration. They were approved on the basis of randomized comparisons showing an improved safety profile (specifically, reduced cardiovascular toxicities) relative to diethylstilbestrol, with equivalent potency. The initial rise in testosterone may result in a clinical flare of the disease. These agents are therefore contraindicated in men with significant obstructive symptoms, cancer-related pain, or spinal cord compromise.

Agents that lower testosterone are associated with an androgen-depletion syndrome that includes hot flashes, weakness, fatigue, impotence, loss of muscle mass, changes in personality, anemia, depression, and a reduction in bone density. The bone changes can be prevented by treatment with bisphosphonates along with vitamin D and calcium supplementation. GnRH analogues also lead to an alteration in body composition and to glucose intolerance. Many taking them develop the metabolic syndrome.



**FIGURE 39-3**  
Sites of action of different hormone therapies.



**Antiandrogens** Nonsteroidal antiandrogens such as flutamide, bicalutamide, and nilutamide block the binding of androgens to the receptor. When an antiandrogen is given alone, testosterone levels remain the same or increase. Compared to testosterone-lowering therapies, antiandrogens cause fewer hot flashes, less of an effect on libido, less muscle wasting, fewer personality changes, and less bone loss. Gynecomastia remains a significant problem but can be alleviated in part by tamoxifen.

Antiandrogens were approved initially to block the flare that results from GnRH analogue administration. They have also been studied as monotherapy and as part of a combined androgen blockade (also called maximal androgen blockade). Most reported randomized trials suggest that the cancer-specific outcomes are inferior when antiandrogens are used alone. Bicalutamide, even at 150 mg (three times the recommended dose), was associated with a shorter time to progression and inferior survival compared to surgical castration for patients with established metastatic disease. Nevertheless, some men may accept the trade-off of a potentially inferior cancer outcome for an improved quality of life.

Combined androgen blockade—the administration of an antiandrogen plus a GnRH analogue or surgical orchiectomy—was designed to inhibit both testicular and adrenal androgens at the outset. Cumulative results of randomized comparisons involving thousands of patients showed no advantage for combining an antiandrogen with surgical orchiectomy; separate analyses of trials combining an antiandrogen with a GnRH analogue have shown a modest (<10%) survival advantage. Meta-analysis of all combined androgen blockade trials concluded that the approach was not more effective. In practice, most patients treated with a GnRH analogue receive an antiandrogen for the first 2–4 weeks of treatment to protect against the flare.

**Intermittent Hormone Therapy** Another way to reduce the side effects of androgen depletion is to administer hormones on an intermittent basis. This was proposed as a way to prevent the selection of cells that are resistant to androgen depletion. The hypothesis is that by allowing endogenous testosterone levels to rise, the cells that survive androgen depletion will induce a normal differentiation pathway. In this way, the surviving cells that are allowed to proliferate in the presence of androgen will retain sensitivity to subsequent androgen depletion. Applied in the clinic, androgen depletion is continued for 2–6 months beyond the point of maximal response. Once treatment is stopped, endogenous testosterone levels increase, and the symptoms associated with hormone treatment abate. PSA levels also begin to rise, and at some level treatment is restarted. With this approach, multiple cycles of regression and proliferation have been documented in individual patients. It is

unknown whether the intermittent approach increases, decreases, or does not change the overall duration of sensitivity to androgen depletion. The preliminary reports suggest that the approach is safe, but long-term data are needed to assess the course in men with low PSA levels. A trial to address this question is ongoing.

**Outcomes of Androgen Depletion** The antipr prostate cancer effects of the various androgen depletion strategies are similar, and the clinical course is predictable: an initial response, then a period of stability in which tumor cells are dormant and not proliferating, followed after a variable period of time by a rise in PSA and regrowth that is visible on a scan as a castration-resistant lesion. Androgen depletion is not curative because cells that survive castration are present when the disease is first diagnosed. Considered by disease manifestation, PSA levels return to normal in 60–70% of patients, and measurable disease regression occurs in 50%; improvements in bone scan occur in 25% of cases, but most remain stable. Duration of survival is inversely proportional to disease extent at the time androgen depletion is first started.

An active question is whether hormones should be given in the adjuvant setting after surgery or radiation treatment of the primary tumor or at the time that a PSA recurrence is documented, or to wait until metastatic disease or symptoms of disease are manifest. Trials in support of early therapy have often been underpowered relative to the reported benefit or have been criticized on methodologic grounds. One trial, although it showed a survival benefit for patients treated with radiation therapy and 3 years of androgen depletion relative to radiation alone, was criticized for the poor outcomes of the control group. Another showing a survival benefit for patients with positive lymph nodes who were randomized to immediate medical or surgical castration compared to observation ( $p = 0.02$ ) was criticized because the confidence intervals around the 5- and 8-year survival distributions for the two groups overlapped. A large randomized study comparing early to late hormone treatment (orchiectomy or GnRH analogue) in patients with locally advanced or asymptomatic metastatic disease showed that patients treated early were less likely to progress from M0 to M1 disease, to develop pain, and to die of prostate cancer. This trial was criticized because therapy was delayed “too long” in the late-treatment group. When patients treated by radical surgery, radiation therapy, or active surveillance were randomly assigned to receive bicalutamide, 150 mg, or placebo, hormone treatment produced a significant reduction in the proportion of patients who developed osseous metastases at 2 years (9% for bicalutamide; 13.8% for placebo). This result has not gained acceptance in part because too many “good-risk” patients

were treated and because no effect on survival was demonstrated. These criticisms are valid; however, the net influence on survival from early hormone intervention is similar to that observed in patients with breast cancer, for which adjuvant hormonal therapy is routinely given.

**METASTATIC DISEASE: CASTRATE** Castration-resistant disease can manifest in many ways. For some it is a rise in PSA with no change in radiographs and no new symptoms. In others it is a rising PSA and progression in bone with or without symptoms of disease. Still others show soft tissue disease with or without osseous metastases, and others have visceral spread. The prognosis, which is highly variable, can be predicted using nomograms designed for the castration-resistant disease state. The important point is that despite the failure of first-line hormone treatment, most of these tumors remain sensitive to second- and third-line hormonal treatments. Castration resistance does not indicate that the tumor is “hormone-refractory.” The rising PSA is an indication of continued signaling through the androgen receptor axis.

The manifestations of disease in this patient group hinder the assessment of drugs and treatment standards because traditional measures of outcome such as tumor regression do not apply. Bone scans can be inaccurate for assessing changes in osseous disease, and no PSA-based outcome is a true surrogate for survival benefit. It is essential to define therapeutic objectives before initiating treatment because there are defined standards of care for different disease manifestations. Therapeutic objectives need not be defined by survival only as useful end points also include relief of symptoms and delay of metastases or new symptoms of disease.

The management of patients with castrate metastatic disease requires first that the castrate status be documented. Patients receiving an antiandrogen alone, whose serum testosterone levels are elevated, should be treated first with a GnRH analogue or orchiectomy and observed for response. Patients on an antiandrogen in combination with a GnRH analogue should have the antiandrogen discontinued because ~20% will respond to the selective discontinuation of the antiandrogen. Any withdrawal response occurs within weeks of stopping flutamide but may take 8–12 weeks with nilutamide and bicalutamide because of their long terminal half-lives. At the time of progression, a different antiandrogen can be given because some tumors are not cross-resistant. An additional consideration in this setting is that significant androgen production persists in the adrenal gland and that one of the adaptive/selective changes, which occurs in the tumor itself, is the upregulation of adrenal synthetic enzymes, leading to autocrine signaling. High-dose ketoconazole, which inhibits adrenal androgen synthesis, is also often effective in

these cases. Other hormones that may be active include estrogens, progestins, and glucocorticoids. Cytotoxic agents are considered when hormones are no longer effective or the tempo of the illness suggests a more aggressive approach is needed.

Mitoxantrone was the first cytotoxic agent approved to provide palliation of pain secondary to castrate metastatic disease. The results established the important principle that systemic chemotherapy can provide palliation of pain in the absence of a survival benefit. In this trial, mitoxantrone-treated patients had a greater reduction in pain, less use of narcotics, and less fatigue. In 2004, docetaxel was established as the first-line standard cytotoxic drug for patients in this state, based on a trial showing that q3w docetaxel was superior to weekly therapy and to mitoxantrone. The results were confirmed in a second trial of estramustine/docetaxel versus mitoxantrone. The addition of estramustine produced significant toxicity with no apparent improvement in survival and has been dropped from these regimens. Docetaxel and other microtubule targeted agents produce PSA declines in 50% of patients, measurable disease regression in 25%, and both an improvement in preexisting and prevention of future cancer-related pain.

Management of pain is a critical part of therapy. Optimal palliation requires assessing whether the symptoms and metastases are focal or diffuse and whether disease threatens the spinal cord, the cauda equina, or the base of the skull. Neurologic symptoms require emergency evaluation because loss of function may be permanent if not addressed quickly. Single sites of pain and areas of neurologic involvement are best treated with external beam radiation. Because the disease is often diffuse, palliation at one site often is followed by the emergence of symptoms in a separate site that had not received radiation.

Given the bone-dominant pattern of prostate cancer spread, two bone-seeking radioisotopes,  $^{89}\text{Sr}$  (Metastron) and  $^{153}\text{Sm-EDTMP}$  (Quadramet), are approved for palliation of pain, although they have no effect on PSA or survival. Fewer patients treated with one of these isotopes developed new areas of pain or required additional radiation therapy compared to patients receiving external beam radiation therapy alone. Additionally, patients randomly assigned to a combination of  $^{89}\text{Sr}$  and doxorubicin after induction chemotherapy had fewer skeletal events and longer survival than patients treated with doxorubicin alone. Confirmatory studies are ongoing. Addition of the bisphosphonate zoledronate to “standard therapy” in patients with castration-resistant disease resulted in fewer skeletal events relative to placebo. The skeletal events included microfractures, new pain, and need for radiation therapy. Bisphosphonates have a dual role: to protect against the bone loss associated with androgen depletion and to prevent skeletal events.

## SYMPTOMS

Benign proliferative disease may produce hesitancy, intermittent voiding, a diminished stream, incomplete emptying, and postvoid leakage. The severity of these symptoms can be quantitated with the self-administered American Urological Association Symptom Index (Table 39-2), although the degree of symptoms does not always relate to gland size. Resistance to urine flow reduces bladder compliance, leading to nocturia, urgency, and, ultimately, urinary retention. An episode of urinary retention may be precipitated by infection, tranquilizing drugs, antihistamines, and alcohol. Prostatitis often produces pain or induration. Typically, the symptoms remain stable over time and obstruction does not occur.

## DIAGNOSTIC PROCEDURES AND TREATMENT

Asymptomatic patients do not require treatment regardless of the size of the gland, whereas those with an inability to urinate, gross hematuria, recurrent infection, or bladder stones may require surgery. In patients with symptoms, uroflowmetry can identify those with normal

flow rates who are unlikely to benefit from surgery and those with high postvoid residuals who may need other interventions. Pressure-flow studies detect primary bladder dysfunction. Cystoscopy is recommended if hematuria is documented and to assess the urinary outflow tract before surgery. Imaging of the upper tracts is advised for patients with hematuria, a history of calculi, or prior urinary tract problems.

Medical therapies for BPH include 5 $\alpha$ -reductase inhibitors and  $\alpha$ -adrenergic blockers. Finasteride (10 mg/d PO) and other 5 $\alpha$ -reductase inhibitors that block the conversion of testosterone to dihydrotestosterone decrease prostate size, increase urine flow rates, and improve symptoms. They also lower baseline PSA levels by 50%, an important consideration when using PSA to guide biopsy recommendations.  $\alpha$ -Adrenergic blockers such as terazosin (1–10 mg PO at bedtime) act by relaxing the smooth muscle of the bladder neck and increasing peak urinary flow rates. No data show that these agents influence the progression of the disease.

Surgical approaches include TURP, transurethral incision, or removal of the gland via a retropubic, suprapubic, or perineal approach. Also utilized are TULIP (transurethral ultrasound-guided laser-induced prostatectomy), stents, and hyperthermia.

TABLE 39-2

AUA SYMPTOM INDEX

QUESTIONS TO BE ANSWERED	AUA SYMPTOM SCORE (CIRCLE 1 NUMBER ON EACH LINE)					
	NOT AT ALL	LESS THAN 1 TIME IN 5	LESS THAN HALF THE TIME	ABOUT HALF THE TIME	MORE THAN HALF THE TIME	ALMOST ALWAYS
Over the past month, how often you have had a sensation of not emptying your bladder completely after you finished urinating?	0+	1	2	3	4	5
Over the past month, how often have you had to urinate again less than 2 h after you finished urinating?	0	1	2	3	4	5
Over the past month, how often have you found you stopped and started again several times when you urinated?	0	1	2	3	4	5
Over the past month, how often have you found it difficult to postpone urination?	0	1	2	3	4	5
Over the past month, how often have you had a weak urinary stream?	0	1	2	3	4	5
Over the past month, how often have you had to push or strain to begin urination?	0	1	2	3	4	5
Over the past month, how many times did you most typically get up to urinate from the time you went to bed at night until the time you got up in the morning?	(None)	(1 time)	(2 times)	(3 times)	(4 times)	(5 times)
Sum of 7 circled numbers (AUA Symptom Score): _____						

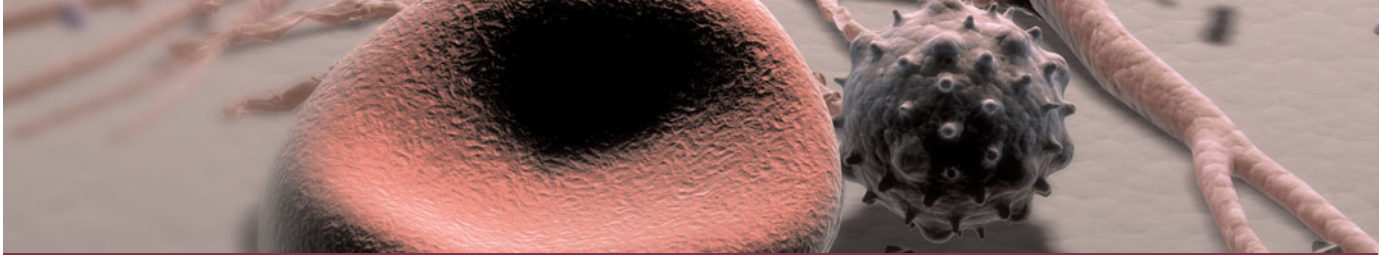
**Note:** AUA, American Urological Association.

**Source:** Barry MJ et al: J Urol 148:1549, 1992. Used with permission.

## FURTHER READINGS

- ATTAR RM et al: Castration-resistant prostate cancer: Locking up the molecular escape routes. *Clin Cancer Res* 15:3251, 2009
- LOBLAW DA et al: Initial hormonal management of androgen-sensitive metastatic, recurrent, or progressive prostate cancer: 2006 update of an American Society of Clinical Oncology practice guideline. *J Clin Oncol* 25:1596, 2007
- LOEB S, CATALONA WJ: Prostate-specific antigen in clinical practice. *Cancer Letters* 249:30, 2007
- NELSON WG et al: Prostate cancer. *N Engl J Med* 349:366, 2003
- PELTIER A et al: Current management of erectile dysfunction after cancer treatment. *Curr Opin Oncol* 21:303, 2009
- PINTO F et al: Progression, risk factors and subsequent medical management of symptomatic benign prostatic hyperplasia. *Arch Ital Urol Androl* 81:1, 2009

- SCHER HI, HELLER G: Clinical states in prostate cancer: Toward a dynamic model of disease progression. *Urology* 55:323, 2000
- TANNOCK IM et al: Docetaxel plus prednisone or mitoxantrone plus prednisone for advanced prostate cancer. *N Engl J Med* 351:1502, 2004
- TAYLOR LG et al: Review of major adverse effects of androgen-deprivation therapy in men with prostate cancer. *Cancer* 115:2388, 2009
- THOMPSON IM et al: The influence of finasteride on the development of prostate cancer. *N Engl J Med* 349:215, 2003
- THORPE A, NEAL D: Benign prostatic hyperplasia. *Lancet* 361:1359, 2003
- YAO SL, DIPAOLA RS: Evidence-based approach to prostate cancer follow-up. *Semin Oncol* 30:390, 2003



## CHAPTER 40

# TESTICULAR CANCER

Robert J. Motzer ■ George J. Bosl

Incidence and Epidemiology .....	524
Etiology and Genetics .....	524
Clinical Presentation .....	524
Pathology .....	525
Tumor Markers .....	526
Extragenital GCT and Midline Carcinoma of Uncertain Histogenesis .....	529
Fertility .....	529
■ Further Readings .....	529

Primary germ cell tumors (GCTs) of the testis, arising by the malignant transformation of primordial germ cells, constitute 95% of all testicular neoplasms. Infrequently, GCTs arise from an extragonadal site, including the mediastinum, retroperitoneum, and, very rarely, the pineal gland. This disease is notable for the young age of the afflicted patients, the totipotent capacity for differentiation of the tumor cells, and its curability; ~95% of newly diagnosed patients are cured. Experience in the management of GCTs leads to improved outcome.

### INCIDENCE AND EPIDEMIOLOGY



In 2007, 7920 new cases of testicular GCT were diagnosed in the United States; the incidence is decreasing after having increased slowly over the past 40 years. The tumor occurs most frequently in men between the ages of 20 and 40. A testicular mass in a male  $\geq 50$  years should be regarded as a lymphoma until proved otherwise. GCT is at least four to five times more common in white than in African American men, and a higher incidence has been observed in Scandinavia and New Zealand than in the United States.

### ETIOLOGY AND GENETICS

Cryptorchidism is associated with a severalfold higher risk of GCT. Abdominal cryptorchid testes are at a

higher risk than inguinal cryptorchid testes. Orchiopexy should be performed before puberty, if possible. Early orchiopexy reduces the risk of GCT and improves the ability to save the testis. An abdominal cryptorchid testis that cannot be brought into the scrotum should be removed. About 2% of men with GCTs of one testis develop a primary tumor in the other testis. Testicular feminization syndromes increase the risk of testicular GCT, and Klinefelter's syndrome is associated with mediastinal GCT.

An isochromosome of the short arm of chromosome 12 [ $i(12p)$ ] is pathognomonic for GCT of all histologic types. Excess 12p copy number, either in the form of  $i(12p)$  or as increased 12p on aberrantly banded marker chromosomes, occurs in nearly all GCTs, but the gene(s) on 12p involved in the pathogenesis are not yet defined.

### CLINICAL PRESENTATION

A painless testicular mass is pathognomonic for a testicular malignancy. More commonly, patients present with testicular discomfort or swelling suggestive of epididymitis and/or orchitis. In this circumstance, a trial of antibiotics is reasonable. However, if symptoms persist or a residual abnormality remains, then testicular ultrasound examination is indicated.

Ultrasound of the testis is indicated whenever a testicular malignancy is considered and for persistent or painful

testicular swelling. If a testicular mass is detected, a radical inguinal orchiectomy should be performed. Because the testis develops from the gonadal ridge, its blood supply and lymphatic drainage originate in the abdomen and descend with the testis into the scrotum. An inguinal approach is taken to avoid breaching anatomic barriers and permitting additional pathways of spread.

Back pain from retroperitoneal metastases is common and must be distinguished from musculoskeletal pain. Dyspnea from pulmonary metastases occurs infrequently. Patients with increased serum levels of human chorionic gonadotropin (hCG) may present with gynecomastia. A delay in diagnosis is associated with a more advanced stage and possibly worse survival.

The staging evaluation for GCT includes a determination of serum levels of fetoprotein (AFP), hCG, and lactate dehydrogenase (LDH). After orchiectomy, a chest radiograph and a CT scan of the abdomen and pelvis should be performed. A chest CT scan is required if pulmonary nodules or mediastinal or hilar disease is suspected. Stage I disease is limited to the testis, epididymis, or spermatic cord. Stage II disease is limited to retroperitoneal (regional) lymph nodes. Stage III disease is disease outside the retroperitoneum, involving supra-diaphragmatic nodal sites or viscera. The staging may be “clinical”—defined solely by physical examination, blood marker evaluation, and radiographs—or “pathologic”—defined by an operative procedure.

The regional draining lymph nodes for the testis are in the retroperitoneum, and the vascular supply originates from the great vessels (for the right testis) or the renal vessels (for the left testis). As a result, the lymph nodes that are involved first by a right testicular tumor

are the interaortocaval lymph nodes just below the renal vessels. For a left testicular tumor, the first involved lymph nodes are lateral to the aorta (para-aortic) and below the left renal vessels. In both cases, further nodal spread is inferior, contralateral, and, less commonly, above the renal hilum. Lymphatic involvement can extend cephalad to the retrocrural, posterior mediastinal, and supraclavicular lymph nodes. Treatment is determined by tumor histology (seminoma versus nonseminoma) and clinical stage ([Table 40-1](#)).

## PATHOLOGY

GCTs are divided into nonseminoma and seminoma subtypes. Nonseminomatous GCTs are most frequent in the third decade of life and can display the full spectrum of embryonic and adult cellular differentiation. This entity comprises four histologies: embryonal carcinoma, teratoma, choriocarcinoma, and endodermal sinus (yolk sac) tumor. Choriocarcinoma, consisting of both cytotrophoblasts and syncytiotrophoblasts, represents malignant trophoblastic differentiation and is invariably associated with secretion of hCG. Endodermal sinus tumor is the malignant counterpart of the fetal yolk sac and associated with secretion of AFP. Pure embryonal carcinoma may secrete AFP or hCG, or both; this pattern is biochemical evidence of differentiation. Teratoma is composed of somatic cell types derived from two or more germ layers (ectoderm, mesoderm, or endoderm). Each of these histologies may be present alone or in combination with others. Nonseminomatous GCTs tend to metastasize early to sites such as the retroperitoneal lymph nodes and lung parenchyma. One-third of

**TABLE 40-1**

**GERM CELL TUMOR STAGING AND TREATMENT**

STAGE	EXTENT OF DISEASE	TREATMENT	
		SEMINOMA	NONSEMINOMA
IA	Testis only, no vascular/lymphatic invasion (T1)	Radiation therapy	RPLND or observation
IB	Testis only, with vascular/lymphatic invasion (T2), or extension through tunica albuginea (T2), or involvement of spermatic cord (T3) or scrotum (T4)	Radiation therapy	RPLND
IIA	Nodes <2 cm	Radiation therapy	RPLND or chemotherapy often followed by RPLND
IIB	Nodes 2–5 cm	Radiation therapy	RPLND +/- adjuvant chemotherapy or chemotherapy followed by RPLND
IIC	Nodes >5 cm	Chemotherapy	Chemotherapy, often followed by RPLND
III	Distant metastases	Chemotherapy	Chemotherapy, often followed by surgery (biopsy or resection)

**Note:** RPLND, retroperitoneal lymph node dissection.

patients present with disease limited to the testis (stage I), one-third with retroperitoneal metastases (stage II), and one-third with more extensive supradiaphragmatic nodal or visceral metastases (stage III).

Seminoma represents ~50% of all GCTs, has a median age in the fourth decade, and generally follows a more indolent clinical course. Most patients (70%) present with stage I disease, ~20% with stage II disease, and 10% with stage III disease; lung or other visceral metastases are rare. Radiation therapy is the treatment of choice in patients with stage I disease and stage II disease where the nodes are <5 cm in maximum diameter. When a tumor contains both seminoma and nonseminoma components, patient management is directed by the more aggressive nonseminoma component.

## TUMOR MARKERS

Careful monitoring of the serum tumor markers AFP and hCG is essential in the management of patients with GCT because these markers are important for diagnosis, as prognostic indicators, in monitoring treatment response, and in the detection of early relapse. Approximately 70% of patients presenting with disseminated nonseminomatous GCT have increased serum concentrations of AFP and/or hCG. Although hCG concentrations may be increased in patients with either nonseminoma or seminoma histology, the AFP concentration is increased only in patients with nonseminoma. The presence of an increased AFP level in a patient whose tumor shows only seminoma indicates that an occult nonseminomatous component exists and the patient should be treated for nonseminomatous GCT. LDH levels are not as specific as AFP or hCG but are increased in 50–60% patients with metastatic nonseminoma and in up to 80% of patients with advanced seminoma.

AFP, hCG, and LDH levels should be determined before and after orchiectomy. Increased serum AFP and hCG concentrations decay according to first-order kinetics; the half-life is 24–36 h for hCG and 5–7 days for AFP. AFP and hCG should be assayed serially during and after treatment. The reappearance of hCG and/or AFP or the failure of these markers to decline according to the predicted half-life is an indicator of persistent or recurrent tumor.

### **R<sub>x</sub>** Treatment: **TESTICULAR CANCER**

**STAGE I NONSEMINOMA** If, after an orchiectomy (for clinical stage I disease), radiographs and physical examination show no evidence of disease and serum AFP and hCG concentrations are either normal or declining to normal according to the known half-life, patients may be managed by either a nerve-sparing retroperitoneal

lymph node dissection (RPLND) or surveillance. The retroperitoneal lymph nodes are involved by GCT (pathologic stage II) in 20–50% of these patients. The choice of surveillance or RPLND is based on the pathology of the primary tumor. If the primary tumor shows no evidence for lymphatic or vascular invasion and is limited to the testis (T1), then either option is reasonable. If lymphatic or vascular invasion is present or the tumor extends into the tunica, spermatic cord, or scrotum (T2 through T4), then surveillance should not be offered. Either approach should cure >95% of patients.

RPLND is the standard operation for removal of the regional lymph nodes of the testis (retroperitoneal nodes). The operation removes the lymph nodes ipsilateral to the primary site and the nodal groups adjacent to the primary landing zone. The standard (modified bilateral) RPLND removes all node-bearing tissue down to the bifurcation of the great vessels, including the ipsilateral iliac nodes. The major long-term effect of this operation is retrograde ejaculation and infertility. Nerve-sparing RPLND, usually accomplished by identification and dissection of individual nerve fibers, may avoid injury to the sympathetic nerves responsible for ejaculation. Normal ejaculation is preserved in ~90% of patients. Patients with pathologic stage I disease are observed, and only the <10% who relapse require additional therapy. If retroperitoneal nodes are found to be involved at RPLND, then a decision regarding adjuvant chemotherapy is made on the basis of the extent of retroperitoneal disease (see later).

Surveillance is an option in the management of clinical stage I disease when no vascular/lymphatic invasion is found (T1). Only 20–30% of patients have pathologic stage II disease, implying that most RPLNDs in this situation are not therapeutic. Surveillance and RPLND lead to equivalent long-term survival rates. Patient compliance is essential if surveillance is to be successful. Patients must be carefully followed with periodic chest radiography, physical examination, CT scan of the abdomen, and serum tumor marker determinations. The median time to relapse is ~7 months, and late relapses (>2 years) are rare. The 70–80% of patients who do not relapse require no intervention after orchiectomy; treatment is reserved for those who do relapse. When the primary tumor is classified as T2 through T4 (extension beyond testis and epididymis or lymphatic/vascular invasion is identified), nerve-sparing RPLND is preferred. About 50% of these patients have pathologic stage II disease and are destined to relapse without the RPLND.

**STAGE II NONSEMINOMA** Patients with limited, ipsilateral retroperitoneal adenopathy (nodes usually ≤3 cm in largest diameter) and normal levels of AFP and hCG generally undergo a modified bilateral RPLND as primary management. Increased levels of either AFP or

hCG or both imply metastatic disease outside the retroperitoneum; chemotherapy is used in this setting. The local recurrence rate after a properly performed RPLND is very low. Depending on the extent of disease, the postoperative management options include either surveillance or two cycles of adjuvant chemotherapy. Surveillance is the preferred approach for patients with resected “low-volume” metastases (tumor nodes  $\leq 2$  cm in diameter *and*  $< 6$  nodes involved) because the probability of relapse is a third or less. For those who relapse, risk-directed chemotherapy is indicated (see later). Because relapse occurs in  $\geq 50\%$  of patients with “high-volume” metastases ( $> 6$  nodes involved, *or* any involved node  $> 2$  cm in largest diameter, *or* extranodal tumor extension), two cycles of adjuvant chemotherapy should be considered because it results in cure in  $\geq 98\%$  of patients. Regimens consisting of etoposide (100 mg/m<sup>2</sup> daily on days 1–5) plus cisplatin (20 mg/m<sup>2</sup> daily on days 1–5) with or without bleomycin (30 units per day on days 2, 9, and 16) given at 3-week intervals are effective and well tolerated.

**STAGES I AND II SEMINOMA** Inguinal orchiectomy followed by retroperitoneal radiation therapy cures  $\sim 98\%$  of patients with stage I seminoma. The dose of radiation therapy (2500–3000 cGy) is low and well tolerated, and the in-field recurrence rate is negligible. About 2% of patients relapse with supradiaphragmatic or systemic disease. Surveillance has been proposed as an option, and studies have shown that  $\sim 15\%$  of patients relapse. The median time to relapse is 12–15 months, and late relapses ( $> 5$  years) may be more frequent than with nonseminoma. The relapse is usually treated with chemotherapy. Surveillance for clinical stage I seminoma is not recommended.

Nonbulky retroperitoneal disease (stage IIA and IIB) is also treated with radiation therapy. Prophylactic supradiaphragmatic fields are not used. Relapses in the anterior mediastinum are unusual. Approximately 90% of patients achieve relapse-free survival with retroperitoneal masses  $< 5$  cm in diameter. Because at least a third of patients with bulkier disease relapse, initial chemotherapy is preferred for stage IIC disease.

### CHEMOTHERAPY FOR ADVANCED GCT

Regardless of histology, patients with stage IIC and stage III GCT are treated with chemotherapy. Combination chemotherapy programs based on cisplatin at doses of 100 mg/m<sup>2</sup> plus etoposide at doses of 500 mg/m<sup>2</sup> per cycle cure 70–80% of such patients, with or without bleomycin, depending on risk stratification (see later). A complete response (the complete disappearance of all clinical evidence of tumor on physical examination and radiography plus normal serum levels of AFP and hCG for  $\geq 1$  month) occurs after chemotherapy

alone in  $\sim 60\%$  of patients, and another 10–20% become disease-free with surgical resection of residual masses containing viable GCT. Lower doses of cisplatin result in inferior survival rates.

The toxicity of four cycles of the cisplatin/bleomycin/etoposide (BEP) regimen is substantial. Nausea, vomiting, and hair loss occur in most patients, although nausea and vomiting have been markedly ameliorated by modern antiemetic regimens. Myelosuppression is frequent, and symptomatic bleomycin pulmonary toxicity occurs in  $\sim 5\%$  of patients. Treatment-induced mortality due to neutropenia with septicemia or bleomycin-induced pulmonary failure occurs in 1–3% of patients. Dose reductions for myelosuppression are rarely indicated. Long-term permanent toxicities include nephrotoxicity (reduced glomerular filtration and persistent magnesium wasting), ototoxicity, and peripheral neuropathy. When bleomycin is administered by weekly bolus injection, Raynaud’s phenomenon appears in 5–10% of patients. Other evidence of small blood vessel damage is seen less often, including transient ischemic attacks and myocardial infarction.

**RISK-DIRECTED CHEMOTHERAPY** Because not all patients are cured and treatment may cause significant toxicities, patients are stratified into “good-risk” and “poor-risk” groups according to pretreatment clinical features. For good-risk patients, the goal is to achieve maximum efficacy with minimal toxicity. For poor-risk patients, the goal is to identify more effective therapy with tolerable toxicity.

The International Germ Cell Cancer Consensus Group developed criteria to assign patients to three risk groups (good, intermediate, poor) (Table 40-2). The marker cutoffs have been incorporated into the revised TNM (primary tumor, regional nodes, metastasis) staging of GCT. Hence TNM stage groupings are now based on both anatomy (site and extent of disease) and biology (marker status and histology). Seminoma is either good or intermediate risk, based on the absence or presence of nonpulmonary visceral metastases. No poor-risk category exists for seminoma. Marker levels play no role in defining risk for seminoma. Nonseminomas have good-, intermediate-, and poor-risk categories based on the site of the primary tumor, the presence or absence of nonpulmonary visceral metastases, and marker levels.

For  $\sim 90\%$  of patients with good-risk GCTs, four cycles of etoposide plus cisplatin (EP) or three cycles of BEP produce durable complete responses, with minimal acute and chronic toxicity. Pulmonary toxicity is absent when bleomycin is not used and is rare when therapy is limited to 9 weeks; myelosuppression with neutropenic fever is less frequent; and the treatment mortality rate is negligible. About 75% of intermediate-risk patients and



TABLE 40-2

## IGCCCG RISK CLASSIFICATION FOR ADVANCED GERM CELL TUMORS

RISK	NONSEMINOMA	SEMINOMA
Good	Gonadal or retroperitoneal primary site Absent nonpulmonary visceral metastases AFP <1000 ng/mL Beta-hCG <5000 mIU/mL LDH <1.5 × upper limit or normal (ULN)	Any primary site Absent nonpulmonary visceral metastases Any LDH, hCG
Intermediate	Gonadal or retroperitoneal primary site Absent nonpulmonary visceral metastases AFP 1000–10,000 ng/mL Beta-hCG 5000–50,000 mIU/mL LDH 1.5–10 × ULN	Any primary site Presence of nonpulmonary visceral metastases Any LDH, hCG
Poor	Mediastinal primary site Presence of nonpulmonary visceral metastases AFP ≥10,000 ng/mL Beta-hCG >50,000 mIU/mL LDH >10 × ULN	No patients classified as poor prognosis

**Note:** AFP,  $\alpha$  fetoprotein; hCG, human chorionic gonadotropin; LDH, lactate dehydrogenase.

**Source:** From International Germ Cell Cancer Consensus Group.

45% of poor-risk patients achieve durable complete remission with four cycles of BEP, and no regimen has proved superior. More effective therapy is needed.

**POSTCHEMOTHERAPY SURGERY** Resection of residual metastases after the completion of chemotherapy is an integral part of therapy. If the initial histology is nonseminoma and the marker values have normalized, all sites of residual disease should be resected. In general, residual retroperitoneal disease requires a modified bilateral RPLND. Thoracotomy (unilateral or bilateral) and neck dissection are less frequently required to remove residual mediastinal, pulmonary parenchymal, or cervical nodal disease. Viable tumor (seminoma, embryonal carcinoma, yolk sac tumor, or choriocarcinoma) is present in 15%, mature teratoma in 40%, and necrotic debris and fibrosis in 45% of resected specimens. The frequency of teratoma or viable disease is highest in residual mediastinal tumors. If necrotic debris or mature teratoma is present, no further chemotherapy is necessary. If viable tumor is present but completely excised, two additional cycles of chemotherapy are given.

If the initial histology is pure seminoma, mature teratoma is rarely present, and the most frequent finding is necrotic debris. For residual retroperitoneal disease, a complete RPLND is technically difficult owing to extensive

postchemotherapy fibrosis. Observation is recommended when no radiographic abnormality exists on CT scan. Positive findings on a positron emission tomography (PET) scan correlate with viable seminoma in residua, and they mandate surgical excision or biopsy.

**SALVAGE CHEMOTHERAPY** Of patients with advanced GCT, 20–30% fail to achieve a durable complete response to first-line chemotherapy. A combination of cisplatin, ifosfamide, and vinblastine (VelP) cures ~25% of patients as a second-line therapy. Substitution of paclitaxel for vinblastine may be more effective in this setting. Patients are more likely to achieve a durable complete response if they had a testicular primary tumor and relapsed from a prior complete remission to first-line cisplatin-containing chemotherapy. In contrast, if the patient failed to achieve a complete response or has a primary mediastinal nonseminoma, then standard-dose salvage therapy is rarely beneficial. Treatment options for such patients include dose-intensive treatment, experimental therapies, and surgical resection.

Chemotherapy consisting of dose-intensive, high-dose carboplatin ( $\geq 1500$  mg/m<sup>2</sup>) plus etoposide ( $\geq 1200$  mg/m<sup>2</sup>), with or without cyclophosphamide, or ifosfamide, with peripheral blood stem cell support, induces a complete response in 25–40% of patients who have progressed after ifosfamide-containing

salvage chemotherapy. About half of the complete responses will be durable. High-dose therapy is the treatment of choice and standard of care for this patient population. Paclitaxel is also active in previously treated patients and shows promise in high-dose combination programs. Cure is still possible in some relapsed patients.

### EXTRAGONADAL GCT AND MIDLINE CARCINOMA OF UNCERTAIN HISTOGENESIS

The prognosis and management of patients with extragonadal GCT depends on the tumor histology and site of origin. All patients with a diagnosis of extragonadal GCT should have a testicular ultrasound examination. Nearly all patients with retroperitoneal or mediastinal seminoma achieve a durable complete response to BEP or EP. The clinical features of patients with primary retroperitoneal nonseminoma GCT are similar to those of patients with a primary of testis origin, and careful evaluation will find evidence of a primary testicular GCT in about two-thirds of cases. In contrast, a primary mediastinal nonseminomatous GCT is associated with a poor prognosis; one-third of patients are cured with standard therapy (four cycles of BEP). Patients with newly diagnosed mediastinal nonseminoma are considered to have poor-risk disease and should be considered for clinical trials testing regimens of possibly greater efficacy. In addition, mediastinal nonseminoma is associated with hematologic disorders, including acute myelogenous leukemia, myelodysplastic syndrome, and essential thrombocytosis unrelated to previous chemotherapy. These hematologic disorders are very refractory to treatment. Nonseminoma of any primary site may change into other malignant histologies such as embryonal rhabdomyosarcoma or adenocarcinoma. This is called malignant transformation. i(12p) has been identified in the transformed cell type, indicating GCT clonal origin.

A group of patients with poorly differentiated tumors of unknown histogenesis, midline in distribution, and not associated with secretion of AFP or hCG has been described; a few (10–20%) are cured by standard cisplatin-containing chemotherapy. i(12p) is present in ~25% of such tumors (the fraction that are cisplatin-responsive), confirming their origin from primitive germ cells. This finding is also predictive of the response

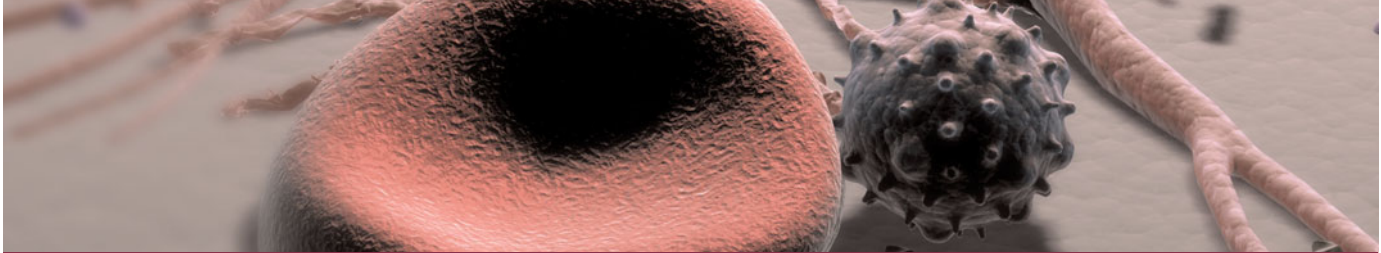
to cisplatin-based chemotherapy and resulting long-term survival. These tumors are heterogeneous; neuroepithelial tumors and lymphoma may also present in this fashion.

### FERTILITY

Infertility is an important consequence of the treatment of GCTs. Preexisting infertility or impaired fertility is often present. Azoospermia and/or oligospermia are present at diagnosis in at least 50% of patients with testicular GCTs. Ejaculatory dysfunction is associated with RPLND, and germ cell damage may result from cisplatin-containing chemotherapy. Nerve-sparing techniques to preserve the retroperitoneal sympathetic nerves have made retrograde ejaculation less likely in the subgroups of patients who are candidates for this operation. Spermatogenesis does recur in some patients after chemotherapy. However, because of the significant risk of impaired reproductive capacity, semen analysis and cryopreservation of sperm in a sperm bank should be recommended to all patients before treatment.

### FURTHER READINGS

- BOSL GJ et al: Testicular germ-cell cancer. *N Engl J Med* 337:242, 1997
- et al: Cancer of the testis, in *Cancer: Principles and Practice of Oncology*, 7th ed, VT DEVITA et al (eds). Philadelphia, Lippincott Williams & Wilkins, 2005, pp 1269–1294
- CHAGANTI RSK, HOULDSWORTH J: Genetics and biology of human male germ cell tumors. *Cancer Res* 60:1475, 2000
- GILBERT DC et al: Reducing treatment toxicities in the management of good prognosis testicular germ cell tumors. *Expert Rev Anticancer Ther* 9:223, 2009
- INTERNATIONAL GERM CELL CANCER CONSENSUS GROUP: International Germ Cell Consensus Classification: A prognostic factor-based staging system for metastatic germ cell cancers. *J Clin Oncol* 15:594, 1997
- KESSLER KA, EINHORN LH: Multimodality treatment of germ cell tumors of the mediastinum. *Thorac Surg Clin* 19:149, 2009
- KONDAGUNTA GV et al: Etoposide and cisplatin chemotherapy for metastatic good-risk germ cell tumors. *J Clin Oncol* 23: 9290, 2005
- MANNUEL HD, HUSSAIN A: Update on testicular germ cell tumors. *Curr Opin Oncol* 21:254, 2009
- MOORE CJ et al: Management of difficult germ-cell tumors. *Oncology* 20:1565, 2006
- MOTZER R et al: Sequential dose-intensive paclitaxel, ifosfamide, carboplatin, and etoposide salvage therapy for germ cell tumor patients. *J Clin Oncol* 18:1173, 2000
- SONPAUDE G et al: Management of recurrent testicular germ cell tumors. *Oncologist* 12:51, 2007
- WOOD HM, ELDER JS: Cryptorchidism and testicular cancer: Separating fact from fiction. *J Urol* 181:452, 2009



## CHAPTER 41

# GYNECOLOGIC MALIGNANCIES

Robert C. Young

■ Ovarian Cancer . . . . .	.530	Pathology . . . . .	.535
Incidence and Epidemiology . . . . .	.530	Staging . . . . .	.536
Etiology and Genetics . . . . .	.531	■ Cervix Cancer . . . . .	.536
Clinical Presentation and Differential Diagnosis . . . . .	.531	Incidence and Epidemiology . . . . .	.536
Screening . . . . .	.531	Etiology and Genetics . . . . .	.536
Pathology . . . . .	.532	Screening and Prevention . . . . .	.537
Staging and Prognostic Factors . . . . .	.532	Clinical Presentation and Staging . . . . .	.537
Ovarian Germ Cell Tumors . . . . .	.534	■ Gestational Trophoblastic Neoplasia . . . . .	.538
Ovarian Stromal Tumors . . . . .	.534	Epidemiology . . . . .	.538
■ Carcinoma of the Fallopian Tube . . . . .	.535	Pathology and Etiology . . . . .	.538
■ Uterine Cancer . . . . .	.535	Clinical Presentation . . . . .	.538
Incidence and Epidemiology . . . . .	.535	■ Further Readings . . . . .	.539
Clinical Presentation . . . . .	.535		

## OVARIAN CANCER

### INCIDENCE AND EPIDEMIOLOGY

Ovarian cancer can develop from three distinctive cell types (germ cells, stromal cells, and epithelial cells), and each of these presents with distinctive features and outcomes and requires widely different management approaches. Epithelial ovarian cancer is the most common of the three and the leading cause of death from gynecologic cancer in the United States. In 2007, 22,430 new cases were diagnosed, and 15,280 women died from ovarian cancer. Epithelial ovarian cancer accounts for 5% of all cancer deaths in women in the United States; more women die of this disease than from cervical and endometrial cancer combined.

The age-specific incidence of the common epithelial type of ovarian cancer increases progressively and peaks in the eighth decade. Epithelial tumors, unlike germ cell and stromal tumors, are uncommon before the age of 40. Epidemiologic studies suggest higher incidences in women with a family history; in those who have been exposed to asbestos or talc; in industrialized nations; and in women with disordered ovarian function, including

infertility, nulliparity, and frequent miscarriages. The use of ovulation-inducing drugs such as clomiphene has been implicated, but the studies have produced mixed results. Reduction in ovarian cancer risk is associated with pregnancy (each pregnancy reduces the ovarian cancer risk by ~10%), breast-feeding, and tubal ligation. Oral contraceptives reduce the risk of ovarian cancer in patients with a family history of cancer and in the general population. Many of these risk-reduction factors support the “incessant ovulation” hypothesis for ovarian cancer etiology, which implies that an aberrant repair process of the surface epithelium is central to ovarian cancer development. Estrogen replacement after menopause does not appear to increase the risk of ovarian cancer, although its use has declined substantially since the HRT trials demonstrated an increased cardiovascular risk.

Familial cases account for ~10% of all ovarian cancer. Compared to a lifetime risk of 1.6% in the general population, women with one affected first-degree relative have a 5% risk. In families with two or more affected first-degree relatives, the risk may exceed 50%. Two types of autosomal dominant familial cancers have been identified: (1) breast/ovarian cancer syndrome; and (2) the

Lynch type II cancer family syndrome with nonpolyposis colorectal cancer, endometrial cancer, and ovarian cancer.

## ETIOLOGY AND GENETICS

In women with hereditary breast/ovarian cancer, two susceptibility loci have been identified: *BRCA1*, located on chromosome 17q12-21, and *BRCA2*, on 13q12-13. Both are tumor-suppressor genes that produce nuclear proteins that interact with RAD 51, which affects genomic integrity. Both genes are large, and numerous mutations have been described; most are frameshift or nonsense mutations, and 86% produce truncated protein products. The implications of the many other mutations, including many missense mutations, are not known. The cumulative risk of ovarian cancer with critical mutations of *BRCA1* or -2 is 25%. Mutated genes can be inherited from either parent, so a complete family history is required. Men in such families have an increased risk of prostate cancer.

The Lynch type II syndrome is associated with an increased risk of ovarian cancer. Affected women often present at a younger age (<50 years). The predisposition results from germline mutations of mismatch repair genes (*MSH2*, *MLH1*, *MLH6*, *PMS1*, and *PMS2*). Because the risk of both endometrial and ovarian cancer is high, intensified screening and prophylactic surgery are often considered.

## CLINICAL PRESENTATION AND DIFFERENTIAL DIAGNOSIS

Seventy percent of patients with ovarian cancer are first diagnosed when the disease has already spread beyond the true pelvis. The occurrence of abdominal pain, bloating, and urinary symptoms usually indicates advanced disease. Localized ovarian cancer is generally asymptomatic. However, progressive enlargement of a localized ovarian tumor can produce urinary frequency or constipation. Rarely, torsion of an ovarian mass causes acute abdominal pain or a surgical abdomen. In contrast to cervical or endometrial cancer, vaginal bleeding or discharge is rarely seen with early ovarian cancer. The diagnosis of early disease usually occurs with palpation of an asymptomatic adnexal mass during routine pelvic examination or as an incidental finding at surgery. However, most ovarian enlargements discovered on physical examination, especially in premenopausal women, are benign functional cysts that characteristically resolve over one to three menstrual cycles. Adnexal masses in premenarchal or postmenopausal women are more likely to be pathologic. A solid, irregular, fixed pelvic mass is usually ovarian cancer. Ultrasound studies usually show complex cysts with solid elements. Other causes of adnexal masses include pedunculated uterine fibroids, endometriosis, benign ovarian neoplasms, and inflammatory lesions of the bowel.

Evaluation of patients with suspected ovarian cancer should include measurement of CA-125. Between 80% and 85% of patients with epithelial ovarian cancer have levels of CA-125  $\geq 35$  U/mL. Other malignant tumors can also elevate CA-125 levels, including cancers of the endometrium, cervix, fallopian tubes, pancreas, breast, lung, and colon. Certain nonmalignant conditions that can produce moderate elevations of CA-125 levels include pregnancy, endometriosis, pelvic inflammatory disease, and uterine fibroids. About 1% of normal females have serum CA-125 levels  $>35$  U/mL. However, in postmenopausal women with an asymptomatic pelvic mass and CA-125 levels  $\geq 65$  U/mL, the test has a sensitivity of 97% and a specificity of 78%.

## SCREENING

In contrast to patients who present with advanced disease, patients with early ovarian cancers (stages I and II) are commonly curable with conventional therapy. Thus effective screening procedures would improve the cure rate in this disease. Although pelvic examination and CA-125 can occasionally detect early disease, these are relatively insensitive screening procedures. Transvaginal sonography is often used, but significant false-positive results are noted, particularly in premenopausal women. Doppler flow imaging coupled with transvaginal ultrasound may improve accuracy and reduce the high rate of false positives.

CA-125 has significant limitations as a screening test. Half of women with stages I and II ovarian cancer have normal CA-125 levels. Attempts have been made to improve the sensitivity and specificity by combinations of procedures, commonly transvaginal ultrasound and CA-125. In a screening study of 22,000 women, 42 had a positive screen and 11 had ovarian cancer (7 with advanced disease). In addition, eight women with a negative screen developed ovarian cancer. Thus the false-positive rate would lead to a large number of unnecessary (i.e., negative) laparotomies if each positive screen resulted in a surgical exploration. In the United Kingdom, a large collaborative screening trial is underway to prospectively compare various screening techniques with controls. Until the results of such trials are available, the National Institutes of Health Consensus Conference recommended against screening for ovarian cancer among the general population without known risk factors for the disease. Although no evidence shows that screening saves lives, many physicians use annual pelvic examinations, transvaginal ultrasound, and CA-125 to screen women with a family history of ovarian cancer, Lynch type II, or breast/ovarian cancer syndrome.

Proteomic technologies have been used to identify patterns of proteins associated with early disease. Preliminary studies identified all 50 stage I patients with a sensitivity of 100%, a specificity of 95%, and a positive

predictive value of 94%. However, difficulty in consistency of replicate samples, variability of results from different spectroscopy equipment, and the tendency of the artificial intelligence algorithms to overfit the data have limited its utility. Most proteins identified to date have been acute-phase reactants, and extensive fractionation is necessary to identify unique cancer-specific proteins.

## **PATHOLOGY**

Common epithelial tumors comprise most (85%) of the ovarian neoplasms. These may be benign (50%), malignant (33%), or tumors of low malignant potential (16%) (i.e., tumors of borderline malignancy). Epithelial tumors of low malignant potential have the cytologic features of malignancy but do not invade the ovarian stroma. More than 75% of borderline malignancies present in early stage and generally occur in the fourth or fifth decade of life. They usually have 10-year survival of 80–90%.

The five major subtypes of common epithelial tumors are serous (50%); mucinous (25%), endometrioid (15%); clear cell (5%); and Brenner tumors (1%), the latter derived from the urothelium. Benign common epithelial tumors are almost always serous or mucinous and develop in women ages 20–60. They are frequently large (20–30 cm), bilateral, and cystic. Malignant epithelial tumors are usually seen in women >40 years of age.

Although most ovarian tumors are epithelial, two other ovarian tumor types, stromal and germ cell tumors, are distinct in their cell of origin, have different clinical presentations and natural histories, and require different management (see later).

Metastasis to the ovary can occur from breast, colon, gastric, and pancreatic cancers. The Krukenberg tumor was classically described as bilateral ovarian masses from metastatic mucin-secreting gastrointestinal cancers.

## **STAGING AND PROGNOSTIC FACTORS**

Laparotomy is the primary procedure used to establish the diagnosis and provide accurate staging. Less invasive studies may help define the extent of spread, including chest x-rays, abdominal CT or MRI scans, and abdominal and pelvic sonography. Symptoms of bladder or renal dysfunction are evaluated by cystoscopy or intravenous pyelography.

A careful staging laparotomy with a total abdominal hysterectomy and bilateral salpingo-oophorectomy will establish the stage and extent of disease and allow for the cytoreduction of tumor masses in patients with advanced disease. Proper laparotomy requires a vertical incision of sufficient length to ensure adequate examination of the abdominal contents. The presence, amount, and cytology of any ascitic fluid should be noted. The primary tumor should be evaluated for rupture, excrescences, or dense adherence. Careful visual and manual inspection of the

diaphragm and peritoneal surfaces is required. A partial omentectomy should be performed and the paracolic gutters inspected. Pelvic lymph nodes as well as para-aortic nodes in the region of the renal hilus should be biopsied. Because this surgical procedure defines stage, establishes prognosis, and determines the necessity for subsequent therapy, it should be performed by a surgeon with special expertise in ovarian cancer staging. Studies have shown that patients operated on by gynecologic oncologists were properly staged 97% of the time, compared to 52% and 35% of cases staged by obstetricians/gynecologists and general surgeons, respectively. After staging, ~23% of women have stage I disease (cancer confined to the ovary or ovaries), 13% have stage II (disease confined to the true pelvis), 47% have stage III (disease spread into but confined to the abdomen), and 16% have stage IV disease (spread outside the pelvis and abdomen). The 5-year survival correlates with stage of disease: stage I, 90–95%; stage II, 70–80%; stage III, 25–50%; and stage IV, 1–5% ([Table 41-1](#)).

Prognosis in ovarian cancer depends not only on stage but on the extent of residual disease and histologic grade. Patients presenting with advanced disease but left without significant residual disease after surgery have a median survival of 39 months, compared to 17 months for those with suboptimal tumor resection.

If initial surgery does not produce minimal residual disease, a second cytoreductive surgery has been used after the first three cycles of chemotherapy; in one trial it was associated with a 6-month improvement in median duration of survival. Another randomized trial where more aggressive debulking surgery was initially carried out was unable to confirm this benefit.

Prognosis of epithelial tumors is also highly influenced by histologic grade but less so by histologic type. Although grading systems differ among pathologists, all grading systems show a better prognosis for well-differentiated or moderately differentiated tumors than for poorly differentiated histologies. Estimated 5-year survivals for patients by tumor grade are well-differentiated, 88%; moderately differentiated, 58%; and poorly differentiated, 27%.

The prognostic significance of pre- and postoperative CA-125 levels is uncertain. CA-125 levels generally reflect volume of disease, and high levels usually indicate unresectability and a poorer survival. Postoperative levels, if elevated, usually indicate residual disease. The rate of decline of CA-125 levels during initial therapy or the absolute level after one to three cycles of chemotherapy correlates with prognosis but is not sufficiently accurate to guide individual treatment decisions. Even when the CA-125 level falls to normal after surgery or chemotherapy, “second-look” laparotomy identifies residual disease in 60% of women.

Genetic and biologic factors may influence prognosis. Increased tumor levels of p53 are associated with a poorer prognosis in advanced disease. Epidermal growth

TABLE 41-1

## STAGING AND SURVIVAL IN GYNECOLOGIC MALIGNANCIES

STAGE	OVARIAN	5-YEAR SURVIVAL, %	ENDOMETRIAL	5-YEAR SURVIVAL, %	CERVIX	5-YEAR SURVIVAL, %
0	—	—	—	—	Carcinoma in situ	100
I	Confined to ovary	90	Confined to corpus	89	Confined to uterus	85
II	Confined to pelvis	70	Involves corpus and cervix	73	Invades beyond uterus but not to pelvic wall	65
III	Intraabdominal spread	25–50	Extends outside the uterus but not outside the true pelvis	52	Extends to pelvic wall and/or lower third of vagina, or hydronephrosis	35
IV	Spread outside abdomen	1–5	Extends outside the true pelvis or involves the bladder or rectum	17	Invades mucosa of bladder or rectum or extends beyond the true pelvis	7

factor receptors in ovarian cancer are associated with a decrease in disease-free survival, but the increased expression of HER-2/neu has given conflicting prognostic results. HER-2/neu is overexpressed in 20% of ovarian cancers, and responses have been seen to trastuzumab in this subset of patients.

### **Rx** Treatment: OVARIAN CANCER

The selection of therapy for patients with epithelial ovarian cancer depends on the stage, extent of residual tumor, and histologic grade. In general, patients are considered in three separate treatment groups: (1) those with early (stages I and II) ovarian cancer and microscopic or no residual disease, (2) patients with advanced (stage III) disease but minimal residual tumor (<1 cm) after initial surgery, and (3) patients with bulky residual tumor and advanced (stage III or IV) disease.

Patients with stage I disease, no residual tumor, and well-differentiated or moderately differentiated tumors need no adjuvant therapy after definitive surgery, and 5-year survival exceeds 95%. For all other patients with early disease and those stage I patients with poor prognosis histologic grade, adjuvant platinum-based therapy is warranted. Large prospective randomized trials have demonstrated that adjuvant therapy improves disease-free and overall survival by 8% (82% vs 74%;  $p = 0.008$ ).

For patients with advanced (stage III) disease but with limited or no residual disease after definitive cytoreductive surgery (about half of all stage III patients), the primary therapy is platinum-based combination chemotherapy. Approximately 70% of women respond to initial combination chemotherapy, and 40–50% have a complete regression of disease. Unfortunately, only about half of these patients are free of disease if

surgically restaged. Although a variety of combinations are active, a randomized prospective trial of paclitaxel and cisplatin compared to paclitaxel and carboplatin in patients with optimally resected advanced disease demonstrated equivalent disease-free and overall survivals but with significantly reduced toxicity with the carboplatin combination. This regimen of paclitaxel, 175 mg/m<sup>2</sup> by 3-h infusion, and carboplatin, dosed to an AUC (area under the curve) of 7.5, is the preferred treatment choice for patients with previously untreated advanced-stage disease.

Three randomized trials using intraperitoneal (IP) chemotherapy have demonstrated improved disease-free and overall survival compared to the intravenous administration of the same drugs. However, the increased toxicity (neuropathy, nephropathy, and catheter complications) is significant, and only ~40% of patients were able to receive full courses of therapy. Furthermore, the optimal dose and schedule of IP therapy has not been established, nor have any of the IP regimens been prospectively compared to the standard intravenous carboplatin-paclitaxel regimen. The ultimate role of IP therapy in the treatment of advanced ovarian cancer is unresolved.

Patients with advanced disease (stages III and IV) and bulky residual tumor are generally treated with an intravenous paclitaxel-platinum combination, and although the overall prognosis is poorer, 5-year survival may reach 15–20%.

Historically, patients who had an excellent initial response to chemotherapy and no clinical evidence of disease had a second-look laparotomy. The second-look surgical procedure itself does not prolong overall survival, and outside of clinical trials its routine use is no longer recommended. Maintenance therapy may extend progression-free survival but has not improved overall survival.

Patients with advanced disease whose disease recurs after initial treatment are usually not curable but may benefit significantly from limited surgery to relieve intestinal obstruction, localized radiation therapy to relieve pressure or pain from mass lesions or metastasis, or palliative chemotherapy. The selection of chemotherapy for palliation depends on the initial regimen and evidence of drug resistance. Patients who had a complete regression of disease lasting  $\geq 6$  months often respond to reinduction with the same agents; patients relapsing within the first 6 months of initial therapy rarely do. Progestational agents, tamoxifen, or aromatase inhibitors produce responses in 5–15% of patients and have minimal side effects. Agents with  $>15\%$  response rates in patients relapsing after initial combination chemotherapy include gemcitabine, topotecan, liposomal doxorubicin, and bevacizumab.

Bevacizumab is a monoclonal antibody that targets the vascular endothelial growth factor. Initial trials produced a 17% overall response rate in heavily pretreated patients. However, hypertension, thrombosis, and bowel perforations have been reported in some trials.

Patients with tumors of low malignant potential, even with advanced-stage disease, have longer survivals (80–90%) when managed with surgery alone. Radiation and chemotherapy do not improve outcome.

## OVARIAN GERM CELL TUMORS

Fewer than 5% of all ovarian tumors are germ cell in origin. They include teratoma, dysgerminoma, endodermal sinus tumor, and embryonal carcinoma. Germ cell tumors of the ovary generally occur in younger women (75% of ovarian malignancies in women  $<30$  years of age), display an unusually aggressive natural history, and are commonly cured with less extensive nonsterilizing surgery and chemotherapy. Women cured of these malignancies are able to conceive and have normal children.

These neoplasms can be divided into three major groups: (1) benign tumors (usually dermoid cysts); (2) malignant tumors that arise from dermoid cysts; and (3) primitive malignant germ cell tumors, including dysgerminoma, yolk sac tumors, immature teratomas, embryonal carcinomas, and choriocarcinoma.

Dermoid cysts are teratomatous cysts usually lined by epidermis and skin appendages. They often contain hair, and calcified bone or teeth can sometimes be seen on conventional pelvic x-ray. They are almost always curable by surgical resection. Approximately 1% of these tumors have malignant elements, usually squamous cell carcinoma.

Malignant germ cell tumors are usually large (median: 16 cm). Bilateral disease is rare except in dysgerminoma (10–15% bilaterality). Abdominal or pelvic pain in young

women is the usual presenting symptom. Serum human chorionic gonadotropin ( $\beta$ -hCG) and  $\alpha$  fetoprotein levels are useful in the diagnosis and management of these patients. Before the advent of chemotherapy, extensive surgery was routine, but it has now been replaced by careful evaluation of extent of spread, followed by resection of bulky disease and preservation of one ovary, the uterus, and the cervix, if feasible. This allows many affected women to preserve fertility. After surgical staging, 60–75% of women have stage I disease and 25–30% have stage III disease. Stages II and IV are infrequent.

Most of the malignant germ cell tumors are managed with chemotherapy after surgery. Regimens similar to those used in testicular cancer, such as BEP (bleomycin, etoposide, and cisplatin), with three or four courses given at 21-day intervals, have produced 95% long-term survival in patients with disease stages I–III. This regimen is the treatment of choice for all malignant germ cell tumors except grade I, stage I immature teratoma, where surgery alone is adequate, and perhaps early-stage dysgerminoma, where surgery and radiation therapy are used.

Dysgerminoma is the ovarian counterpart of testicular seminoma. The tumor is very sensitive to radiation therapy. The 5-year disease-free survival is 100% in early-stage patients and 61% in stage III disease. Unfortunately, the use of radiation therapy makes many patients infertile. BEP chemotherapy is equally or more effective and does not cause infertility. In incompletely resected patients with dysgerminoma treated with BEP, the 2-year disease-free survival is 95% and infertility is not observed. Combination chemotherapy (BEP) has replaced postoperative radiation therapy as the treatment of choice in women with ovarian dysgerminoma.

## OVARIAN STROMAL TUMORS

Stromal tumors make up  $<10\%$  of ovarian tumors. They are named for the stromal tissue involved: granulosa, theca, Sertoli, Leydig, and collagen-producing stromal cells. The granulosa and theca cell stromal cell tumors occur most frequently in the first three decades of life. Granulosa cell tumors frequently produce estrogen and cause menstrual abnormalities, bleeding, and precocious puberty. Endometrial carcinoma can be seen in 5% of these women, perhaps related to the persistent hyperestrogenism. Sertoli and Leydig cell tumors, when functional, produce androgens with resultant virilization or hirsutism. Some 75% of these stromal cell tumors present in stage I and can be cured with total abdominal hysterectomy and bilateral salpingo-oophorectomy. Stromal tumors generally grow slowly, and recurrences can occur 5–10 years after initial surgery; serum markers such as estradiol, inhibin, and müllerian inhibitory substance may be useful in monitoring patients. Neither radiation therapy nor chemotherapy has been documented

to be consistently effective, and surgical management remains the primary treatment.

Ovarian stromal and germ cell tumors are sometimes components of complex genetic syndromes. Peutz-Jeghers syndrome (mucocutaneous pigmentation and intestinal polyps) is associated with ovarian sex cord stromal tumors and Sertoli cell tumors in men. Patients with gonadal dysgenesis (46XY genotype or mosaic for Y-containing cell lines) develop gonadoblastomas, and women with nevroid basal cell carcinomas have an increased risk of ovarian fibromas.

## CARCINOMA OF THE FALLOPIAN TUBE

The fallopian tube is a very rare site of cancer in the female genital tract, although its epithelial surface far exceeds that of the ovary, where epithelial cancer is 20 times more common. Approximately 300 new cases occur yearly; 90% are papillary serous adenocarcinomas, with the remainder mixed mesodermal, endometrioid, and transitional cell tumors. *BRCA1* and *-2* mutations are found in 16% of cases. The gross and microscopic characteristics and the spread of tumor are similar to those of ovarian cancer but can be distinguished if the tumor arises from the endosalpinx, where the tubal epithelium shows a transition between benign and malignant, and the ovaries and endometrium are normal or minimally involved. The differential diagnosis includes primary or metastatic ovarian cancer, chronic salpingitis, tuberculous salpingitis, salpingitis isthmica nodosa, and cautery artifact.

Unlike patients with ovarian cancer, patients often present with early symptoms, usually postmenopausal vaginal bleeding, pain, and leukorrhea. Surgical staging is similar to that used for ovarian cancer, and prognosis is related to stage and extent of residual disease. Patients with stages I and II disease are generally treated with surgery alone or with surgery and pelvic radiation therapy, although radiation therapy does not clearly improve 5-year survival (5-year survival, stage I: 74% vs 75%; stage II: 43% vs 48%). Patients with stages III and IV disease are treated with the same chemotherapy regimens used in advanced ovarian cancer; 5-year survival is similar (stage III, 20%; stage IV, 5%).

## UTERINE CANCER

### INCIDENCE AND EPIDEMIOLOGY

Carcinoma of the endometrium is the most common female pelvic malignancy. Approximately 39,080 new cases are diagnosed yearly, although in most (75%), tumor is confined to the uterine corpus at diagnosis, and therefore most can be cured. The 7400 deaths yearly make uterine cancer only the eighth leading cause of cancer death in females. It is primarily a disease

of postmenopausal women, although 25% of cases occur in women ages <50 and 5% ages <40. The disease is common in Eastern Europe and the United States and uncommon in Asia.

Proliferation of the endometrium is under the control of estrogen, and prolonged exposure to unopposed estrogen from either endogenous or exogenous sources plays a central etiologic role. Risk factors for endometrial cancer include obesity, low fertility index, early menarche, late menopause, and chronic anovulation. Granulosa cell tumors of the ovary that secrete estrogen may present with synchronous endometrial cancers. Chronic unopposed estrogen replacement increases the risk, and women taking tamoxifen for breast cancer treatment or prevention have a twofold increased risk.

The Lynch syndrome occurs in families with an autosomal dominant mutation of mismatch repair genes *MLH1*, *MSH2*, *MSH6*, and *PMS2*, which predispose to nonpolyposis colon cancer as well as endometrial and ovarian cancer. The estimated lifetime risk for endometrial cancer is 40–60%, with a mean age ~50 years. Unlike colorectal cancer, endometrial cancer risk is not lower in *MSH6* mutation carriers. Most women present with stage I disease, and the survival rate is generally good (5-year survival: 88%). No unique endometrial screening strategies have been established for Lynch family gene carriers.

### CLINICAL PRESENTATION

Endometrial carcinoma occurs most often in the sixth and seventh decades of life. Symptoms often include abnormal vaginal discharge (90%), abnormal postmenopausal bleeding (80%), and leukorrhea (10%). The risk of endometrial cancer associated with postmenopausal bleeding increases with advancing age (9% at age 50 vs 60% at age 80). Evaluation of such patients should include a history and physical with pelvic examination followed by an endometrial biopsy or a fractional dilation and curettage. Outpatient procedures such as endometrial biopsy or aspiration curettage can be used but are definitive only when positive.

### PATHOLOGY

Between 75% and 80% of all endometrial carcinomas are adenocarcinomas, and the prognosis depends on stage, histologic grade, and extent of myometrial invasion. Grade I tumors are highly differentiated adenocarcinomas, grade II tumors contain some solid areas, and grade III tumors are largely solid or undifferentiated. Adenocarcinoma with squamous differentiation is seen in 10% of patients; the most differentiated form is known as *adenocanthoma*, and the poorly differentiated form is called *adenosquamous carcinoma*. Other less common pathologies include mucinous carcinoma (5%) and



536 papillary serous carcinoma (<10%). This latter type has a natural history similar to ovarian carcinoma and should be managed in the same way. Rarer histologies include secretory (2%), ciliated, clear cell, and undifferentiated carcinomas.

## STAGING

The staging of endometrial cancer requires surgery to establish the extent of disease and the depth of myometrial invasion. A total abdominal hysterectomy and bilateral salpingo-oophorectomy should be performed and peritoneal fluid sampled. Frozen sections of the uterine specimen are used to determine the histology and grade and depth of invasion. If indicated, pelvic and para-aortic lymphadenectomy is performed. After evaluation and staging, ~75% of patients are stage I, 13% are stage II, 9% are stage III, and 3% are stage IV. Five-year survival declines with advancing stage: stage I, 89%; stage II, 73%; stage III, 52%; and stage IV, 17% (Table 41-1).

### **Rx** Treatment: UTERINE CANCER

Patients with uncomplicated stage I endometrial carcinoma are effectively managed with total abdominal hysterectomy and bilateral salpingo-oophorectomy. Pre- or postoperative irradiation has been used, and although vaginal cuff recurrence is reduced, survival is not altered. In women with poor histologic grade, deep myometrial invasion, or extensive involvement of the lower uterine segment or cervix, intracavitary or external beam irradiation is warranted.

About 15% of women have endometrial carcinoma with extension to the cervix only (stage II), and management depends on the extent of cervical invasion. Superficial cervical invasion can be managed like stage I disease, but extensive cervical invasion requires radical hysterectomy or preoperative radiotherapy followed by extrafascial hysterectomy. Once disease is outside the uterus but still confined to the true pelvis (stage III), management generally includes surgery and irradiation. Patients who have involvement only of the ovary or fallopian tubes generally do well with such therapy (5-year survival of 80%). Other stage III patients with disease extending beyond the adnexa or those with serous carcinomas of the endometrium have a significantly poorer prognosis (5-year survival of 15%). Patients with positive para-aortic nodes (stage IIIC) or those with upper abdominal involvement (stage IV) have shown improved survival with platinum-based chemotherapy compared to whole-abdominal irradiation alone.

Patients with stage IV disease (outside the abdomen or invading the bladder or rectum) are treated palliatively with irradiation, surgery, and platinum-based

chemotherapy. Progestational agents produce responses in ~10–20% of patients. Well-differentiated tumors respond most frequently, and response can be correlated with the level of progesterone receptor expression in the tumor. The commonly used progestational agents hydroxyprogesterone (Delalutin), megestrol (Megace), and deoxyprogesterone (Provera) all produce similar response rates, and the antiestrogen tamoxifen (Nolvadex) produces responses in 10–25% of patients in a salvage setting.

Chemotherapy is not very successful in advanced endometrial carcinoma. The most active single agents with consistent response rates of  $\geq 20\%$  include cisplatin, carboplatin, doxorubicin, epirubicin, and paclitaxel. Combinations of drugs with or without progestational agents have generally produced response rates similar to single agents.

## CERVIX CANCER

### INCIDENCE AND EPIDEMIOLOGY

Carcinoma of the cervix was once the most common cause of cancer death in women, but over the past 40 years, the mortality rate has decreased by 50% due to widespread screening with the Pap smear. In 2007, ~11,150 new cases of invasive cervix cancer occurred, and >50,000 cases of carcinoma in situ were detected. There were 3670 deaths from the disease, and of those patients, ~85% had never had a Pap smear. Worldwide, cervical cancer is the third most common cancer diagnosed, and it remains the major gynecologic cancer in underdeveloped countries. It is more common in lower socioeconomic groups, in women with early initial sexual activity and/or multiple sexual partners, and in smokers.

### ETIOLOGY AND GENETICS

Venereal transmission of the human papilloma virus (HPV) has an important etiologic role. Over 66 types of HPVs have been isolated, and many are associated with genital warts. Those types commonly associated with cervical carcinoma are 16, 18, 31, 33, 52, and 58, but 70% of cases are caused by HPV-16 and -18. These, along with many other types, are also associated with cervical intraepithelial neoplasia (CIN). The protein product of HPV-16, the E7 protein, binds and inactivates the tumor-suppressor gene Rb, and the E6 protein of HPV-18 has sequence homology to the SV40 large T antigen and the capacity to bind and inactivate the tumor-suppressor gene p53. E6 and E7 are both necessary and sufficient to cause cell transformation in vitro. These binding and inactivation events may explain the carcinogenic effects of the viruses.

## SCREENING AND PREVENTION

Vaccination against pathologic HPV appears to be an effective cervix cancer prevention strategy. Vaccines are made with inactivated virus-like particles that are non-infectious but highly immunogenic. The administration of a quadrivalent HPV vaccine against types 16, 18, 6, and 11 in a double-blind study of 2392 women completely prevented infection with the virus, and no cases of HPV-16-related CIN were seen in vaccinated women. This quadrivalent vaccine has been approved for use by the FDA for patients 9–26 years old and must be administered before HPV exposure to be effective. A second study with a bivalent vaccine (types 16 and 18) is underway. Both vaccines appear highly effective in preventing their particular HPV infections, and protection has persisted for at least 4.5 years after three injections over a 6-month period. Because not all oncogenic HPVs are targeted, patients need to continue PAP smear surveillance.

Uncomplicated HPV infection in the lower genital tract can progress to CIN. This lesion precedes invasive cervical carcinoma and is classified as low-grade squamous intraepithelial lesion (SIL), high-grade SIL, and carcinoma in situ. Carcinoma in situ demonstrates cytologic evidence of neoplasia without invasion through the basement membrane and can persist unchanged for 10–20 years, but most of these eventually progress to invasive carcinoma.

The Pap smear is 90–95% accurate in detecting early lesions such as CIN but is less sensitive in detecting cancer when frankly invasive cancer or fungating masses are present. Inflammation, necrosis, and hemorrhage may produce false-positive smears, and colposcopic-directed biopsy is required when any lesion is visible on the cervix, regardless of Pap smear findings. The American Cancer Society recommends that women after onset of sexual activity, or >20 years of age, have two consecutive yearly smears. If negative, smears should be repeated every 3 years until age 65. The Pap smear can be reported as normal (includes benign, reactive, or reparative changes); atypical squamous cells of undetermined significance (ASCUS) or cannot exclude high-grade SIL (ASC-H); low- or high-grade CIN; or frankly malignant. Women with ASCUS, ASC-H, or low-grade CIN should have repeat smears in 3–6 months and be tested for HPV. Women with high-grade CIN or frankly malignant Pap smears should have colposcopic-directed cervical biopsy. Colposcopy is a technique using a binocular microscope and 3% acetic acid applied to the cervix in which abnormal areas appear white and can be biopsied directly. Cone biopsy is still required when endocervical tumor is suspected, colposcopy is inadequate, the biopsy shows microinvasive carcinoma, or when a discrepancy is noted between the Pap smear and the colposcopic findings. Cone biopsy alone is therapeutic for

CIN in many patients, although a less radical electrocautery excision may be sufficient.

Approximately 70% of invasive cervix cancers are squamous cell tumors, 20–25% are adenocarcinomas, and 2–5% are adenosquamous with epithelial and glandular structures.

## CLINICAL PRESENTATION AND STAGING

Patients with cervix cancer generally are asymptomatic, and the disease is detected on routine pelvic examination. Others present with abnormal bleeding or post-coital spotting that may increase to intermenstrual or prominent menstrual bleeding. Yellowish vaginal discharge, lumbosacral back pain, lower-extremity edema, and urinary symptoms may be present.

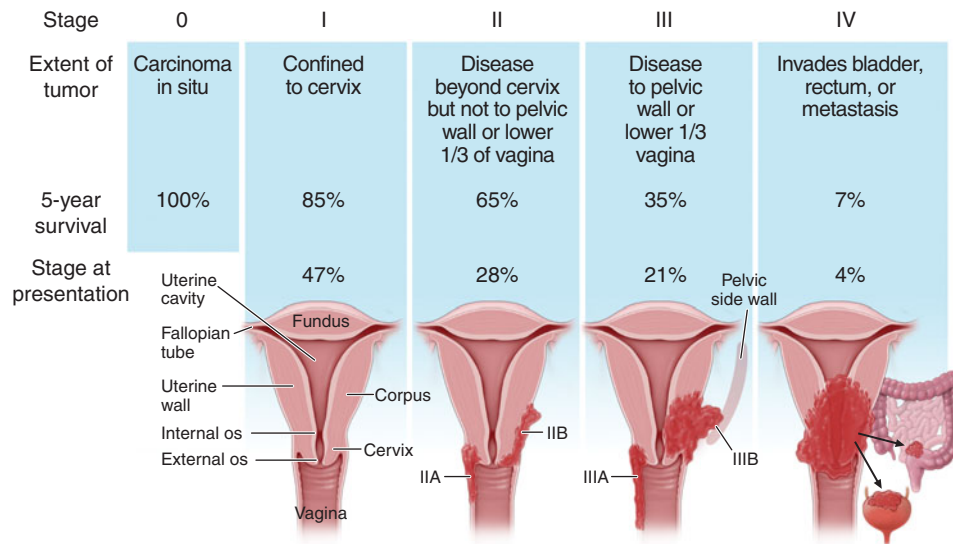
The staging of cervical carcinoma is clinical and generally completed with a pelvic examination under anesthesia with cystoscopy and proctoscopy. Chest x-rays, intravenous pyelograms, and CT are generally required, and MRI may be used to assess extracervical extension. Stage 0 is carcinoma in situ, stage I is disease confined to the cervix, stage II disease invades beyond the cervix but not to the pelvic wall or lower third of the vagina, stage III disease extends to the pelvic wall or lower third of the vagina or causes hydronephrosis, and stage IV is present when the tumor invades the mucosa of bladder or rectum or extends beyond the true pelvis (**Fig. 41-1**). Five-year survivals by stage are stage I, 85%; stage II, 65%; stage III, 35%; and stage IV, 7% (Table 41-1).

### **Rx** Treatment: **CERVIX CANCER**

Carcinoma in situ (stage 0) can be managed successfully by cone biopsy or by abdominal hysterectomy. For stage I disease, results appear equivalent for either radical hysterectomy or radiation therapy. Patients with disease stages II–IV are primarily managed with external beam irradiation and intracavitary treatment or combined modality therapy. Retroperitoneal lymphadenectomy has no proven therapeutic role. Pelvic exenterations have become increasingly rare due to improved radiation control. However, they are sometimes performed for centrally recurrent or persistent disease.

In women with locally advanced disease (stages IIB–IVA), platinum-based chemotherapy given concomitantly with radiation therapy improves survival compared to radiation therapy alone. Cisplatin, 75 mg/m<sup>2</sup> over 4 h, followed by 5-fluorouracil (5-FU), 4 g given by 96-h infusion on days 1–5 of radiation therapy, is a common regimen. Two additional cycles of chemotherapy are given at 3-week intervals. Three randomized trials of platinum-based chemotherapy reduced the risk of recurrence by 30–50% across a wide spectrum of stages

## Staging of cervix cancer



**FIGURE 41-1**  
Anatomic display of the stages of cervix cancer defined by location, extent of tumor, frequency of presentation, and 5-year survival.

and presentations and were found to improve the survival rate in bulky stage I as well as locally advanced (stages IIB–IV) cervical cancer.

Chemotherapy has some palliative benefit in patients with unresectable advanced disease or recurrent disease. Active agents with  $\geq 20\%$  response rates include cisplatin, paclitaxel, vinorelbine, ifosfamide, and topotecan. The combination of topotecan and cisplatin has a modest survival advantage over cisplatin alone.

## GESTATIONAL TROPHOBLASTIC NEOPLASIA

Gestational trophoblastic diseases are a group of related diseases that form a spectrum from benign hydatidiform mole to trophoblastic malignancy (placental-site trophoblastic tumor and choriocarcinoma). Malignant forms account for  $<1\%$  of female gynecologic malignancies and can be cured with appropriate chemotherapy. Deaths from this disease have become rare in the United States.

## EPIDEMIOLOGY



The incidence is  $\sim 1$  per 1500 pregnancies in the United States and is nearly tenfold higher in Asia.

Maternal age  $>45$  years is a risk factor for hydatidiform mole as is a prior history of molar pregnancy. Choriocarcinoma occurs in  $\sim 1$  in 25,000 pregnancies or 1 in 20,000 live births. Prior history of hydatidiform mole is a risk factor for choriocarcinoma. A woman

with a previous molar pregnancy is 1000 times more likely to develop choriocarcinoma than a woman with a prior normal-term pregnancy.

## PATHOLOGY AND ETIOLOGY

The trophoblastic neoplasms have been divided by morphology into complete or partial hydatidiform mole, invasive mole, placental-site trophoblastomas, and choriocarcinomas. Hydatidiform moles contain clusters of villi with hydropic changes, hyperplasia of the trophoblast, and the absence of fetal vessels. Invasive moles differ only by invasion into the uterine myometrium. Placental-site trophoblastic tumors are predominantly made up of cytotrophoblast cells arising from the placental implantation site. Choriocarcinomas consist of anaplastic trophoblastic tissue with both cytotrophoblastic and syncytiotrophoblastic elements and no identifiable villi.

Complete moles result from uniparental disomy in which loss of the maternal genes (23 autosomes plus X) occurs by unknown mechanisms and is followed by duplication of the paternal haploid genome (23 autosomes plus X). Uncommonly (5%), moles result from dispermic fertilization of an empty egg, resulting in either 46XY or 46XX genotype. Partial moles result from dispermic fertilization of an egg with retention of the maternal haploid set of chromosomes, resulting in diandric triploidy.

## CLINICAL PRESENTATION

Molar pregnancies are generally associated with first-trimester bleeding and excessive uterine size. About 45%

of patients have ovarian theca-lutein cysts present on ultrasound. The  $\beta$ -hCG levels are generally markedly elevated. Fetal parts and heart sounds are not present. The diagnosis is generally made by the passage of grape-like clusters from the uterus, but ultrasound demonstration of the hydropic mole can be diagnostic. Patients suspected of a molar pregnancy require a chest film, careful pelvic examinations, and weekly serial monitoring of  $\beta$ -hCG levels.

**Rx Treatment:**  
**GESTATIONAL TROPHOBLASTIC**  
**NEOPLASIA**

Patients with hydatidiform moles require suction curettage coupled with postevacuation monitoring of  $\beta$ -hCG levels. In most women (80%), the  $\beta$ -hCG titer progressively declines within 8–10 days of evacuation (serum half-life is 24–36 h). Patients should be monitored on a monthly basis and should not become pregnant for at least a year. Patients found to have invasive mole at curettage are generally treated with hysterectomy and chemotherapy. Approximately half of patients with choriocarcinoma develop the malignancy after a molar pregnancy, and the other half develop the malignancy after abortion, ectopic pregnancy, or occasionally after a normal full-term pregnancy.

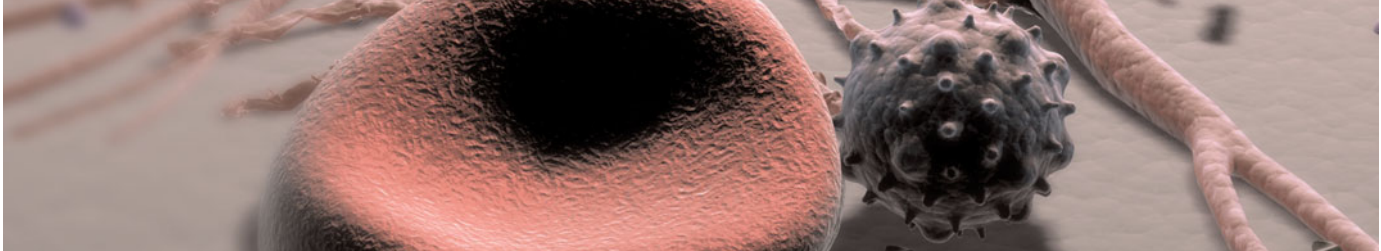
Chemotherapy is used for gestational trophoblastic neoplasia and often as chemoprophylaxis after molar evacuation to reduce postmolar tumors. It is also used in hydatidiform mole if  $\beta$ -hCG levels rise or plateau or if metastases develop. Patients with invasive mole or choriocarcinoma require chemotherapy. Several regimens are effective for low-risk patients, including methotrexate at 30 mg/m<sup>2</sup> intramuscularly on a weekly basis until  $\beta$ -hCG titers are normal. However, methotrexate (1 mg/kg) every other day for four doses, followed by leucovorin (0.1 mg/kg) intravenously 24 h after methotrexate, is associated with a cure rate of  $\geq 90\%$  and low toxicity. Intermittent courses are continued until the  $\beta$ -hCG titer becomes undetectable for 3 consecutive weeks; then patients are monitored monthly for a year.

Patients with high-risk tumors (high  $\beta$ -hCG levels, disease presenting  $\geq 4$  months after antecedent pregnancy, brain or liver metastasis, or failure of single-agent methotrexate) are initially treated with combination chemotherapy. EMA-CO (a cyclic non-cross-resistant combination of etoposide, methotrexate, and dactinomycin alternating with cyclophosphamide and vincristine); cisplatin, bleomycin, and vinblastine; and cisplatin, etoposide, and bleomycin are effective regimens. EMA-CO is now the regimen of choice for patients with high-risk disease because of excellent survival rates

(>80%) and less toxicity. The use of etoposide carries a 1.5% lifetime risk of acute myeloid leukemia (sixteenfold relative risk) and other solid tumors. As a result, etoposide-containing regimens should be reserved for patients with high-risk features. Patients with brain or liver metastases are usually treated with local irradiation to metastatic sites in conjunction with chemotherapy. Long-term studies of patients cured of trophoblastic disease have not demonstrated an increased risk of maternal complications or fetal abnormalities with subsequent pregnancies.

### FURTHER READINGS

- BAST RC Jr et al: The biology of ovarian cancer: New opportunities for translation. *Nat Rev Cancer* 9:415, 2009
- CHAMPION V et al: Quality of life in long-term survivors of ovarian germ cell tumors: A gynecologic oncology group study. *Gynecol Oncol* 105:687, 2007
- CLARKE-PEARSON DL: Clinical practice. Screening for ovarian cancer. *N Engl J Med* 361:170, 2009
- KOUTSKY LA: A controlled trial of a human papilloma virus type 16 vaccine. *N Engl J Med* 347:1645, 2002
- LINDOR NM et al: Recommendations for the care of individuals with an inherited predisposition to Lynch syndrome. *JAMA* 296:1507, 2006
- MODUGNO F; OVARIAN CANCER AND HIGH-RISK WOMEN SYMPOSIUM PRESENTERS: Ovarian cancer and high-risk women: Implications for prevention, screening, and early detection. *Gynecol Oncol* 91:15, 2003
- OZOLS RF et al: Phase III study of cisplatin/paclitaxel compared with carboplatin/paclitaxel in patients with optimally resected stage III epithelial ovarian cancer. *J Clin Oncol* 21:3194, 2003
- RANDALL ME et al: Randomized phase III trial of whole abdominal irradiation vs. doxorubicin and cisplatin chemotherapy in advanced endometrial carcinoma: A Gynecologic Oncology Group study. *J Clin Oncol* 24:36, 2006
- ROSE PG: Secondary surgical cytoreduction for advanced ovarian cancer. *N Engl J Med* 351:2489, 2004
- SOLOMON D et al: The 2001 Bethesda System. *JAMA* 287:2114, 2002
- STEHMAN FB et al: Innovations in the treatment of invasive cervical cancer. *Cancer* 98:2052, 2003
- TANGJITGAMOL S et al: Interval debulking surgery for advanced epithelial ovarian cancer. *Cochrane Database Syst Rev* CD004751, 2009
- TRIMBOS JB et al: International Collaborative Neoplasm trial I and Adjuvant Chemotherapy in Ovarian Neoplasm trial: Two parallel randomized phase III trials of adjuvant chemotherapy in patients with early-stage ovarian carcinoma. *J Natl Cancer Inst* 95:105, 2003
- VAN WIJK FH et al: Management of recurrent endometrioid endometrial carcinoma: An overview. *Int J Gynecol Cancer* 19:314, 2009
- WRIGHT JD, MUTCH DG: Treatment of high-risk gestational trophoblastic tumors. *Clin Obstet Gynecol* 46:593, 2003
- YOUNG RC et al: Adjuvant therapy in stage I and stage II epithelial ovarian cancer. Results of two prospective trials. *N Engl J Med* 327:1021, 1990



## CHAPTER 42

# SOFT TISSUE AND BONE SARCOMAS AND BONE METASTASES

Shreyaskumar R. Patel ■ Robert S. Benjamin

■ Soft Tissue Sarcomas . . . . .	.540	Incidence and Epidemiology . . . . .	.543
Incidence . . . . .	.540	Classification . . . . .	.543
Epidemiology . . . . .	.540	Osteosarcoma . . . . .	.543
Genetic Considerations . . . . .	.541	Chondrosarcoma . . . . .	.544
Classification . . . . .	.541	Ewing's Sarcoma . . . . .	.545
Diagnosis . . . . .	.541	■ Tumors Metastatic to Bone . . . . .	.545
Staging and Prognosis . . . . .	.542	■ Further Readings . . . . .	.546
■ Bone Sarcomas . . . . .	.543		

Sarcomas are rare (<1% of all malignancies) mesenchymal neoplasms that arise in bone and soft tissues. These tumors are usually of mesodermal origin, although a few are derived from neuroectoderm, and they are biologically distinct from the more common epithelial malignancies. Sarcomas affect all age groups; 15% are found in children <15 years and 40% occur after age 55. Sarcomas are one of the most common solid tumors of childhood and are the fifth most common cause of cancer deaths in children. Sarcomas may be divided into two groups: those derived from bone and those derived from soft tissues.

### SOFT TISSUE SARCOMAS

Soft tissues include muscles, tendons, fat, fibrous tissue, synovial tissue, vessels, and nerves. Approximately 60% of soft tissue sarcomas arise in the extremities, with the lower extremities involved three times as often as the upper extremities. Thirty percent arise in the trunk, the retroperitoneum accounting for 40% of all trunk lesions. The remaining 10% arise in the head and neck.

### INCIDENCE

Approximately 9220 new cases of soft tissue sarcomas occurred in the United States in 2007. The annual age-adjusted incidence is 3.0 per 100,000 population, but the incidence varies with age. Soft tissue sarcomas constitute 0.7% of all cancers in the general population and 6.5% of all cancers in children.

### EPIDEMIOLOGY

Malignant transformation of a benign soft tissue tumor is extremely rare, with the exception that malignant peripheral nerve sheath tumors (neurofibrosarcoma, malignant schwannoma) can arise from neurofibromas in patients with neurofibromatosis. Several etiologic factors have been implicated in soft tissue sarcomas.

### Environmental Factors

Trauma or previous injury is rarely involved, but sarcomas can arise in scar tissue resulting from a prior operation, burn, fracture, or foreign body implantation. Chemical carcinogens such as polycyclic hydrocarbons, asbestos, and dioxin may be involved in the pathogenesis.

## Iatrogenic Factors

Sarcomas in bone or soft tissues occur in patients who are treated with radiation therapy. The tumor nearly always arises in the irradiated field. The risk increases with time.


## Viruses

Kaposi's sarcoma (KS) in patients with HIV type 1, classic KS, and KS in HIV-negative homosexual men is caused by human herpes virus (HHV) 8. No other sarcomas are associated with viruses.

## Immunologic Factors

Congenital or acquired immunodeficiency, including therapeutic immunosuppression, increases the risk of sarcoma.

## GENETIC CONSIDERATIONS

 Li-Fraumeni syndrome is a familial cancer syndrome in which affected individuals have germ-line abnormalities of the tumor-suppressor gene p53 and an increased incidence of soft tissue sarcomas and other malignancies, including breast cancer, osteosarcoma, brain tumor, leukemia, and adrenal carcinoma (Chap. 23). Neurofibromatosis 1 (NF-1, peripheral form, von Recklinghausen's disease) is characterized by multiple neurofibromas and café au lait spots. Neurofibromas occasionally undergo malignant degeneration to become malignant peripheral nerve sheath tumors. The gene for NF-1 is located in the pericentromeric region of chromosome 17 and encodes neurofibromin, a tumor-suppressor protein with GTPase-activating activity that inhibits Ras function (Chap. 43). Germ-line mutation of the *Rb-1* locus (chromosome 13q14) in patients with inherited retinoblastoma is associated with the development of osteosarcoma in those who survive the retinoblastoma and of soft tissue sarcomas unrelated to radiation therapy. Other soft tissue tumors, including desmoid tumors, lipomas, leiomyomas, neuroblastomas, and paragangliomas, occasionally show a familial predisposition.

Ninety percent of synovial sarcomas contain a characteristic chromosomal translocation  $t(X;18)(p11;q11)$  involving a nuclear transcription factor on chromosome 18 called *SYT* and two breakpoints on X. Patients with translocations to the second X breakpoint (*SSX2*) may have longer survival than those with translocations involving *SSX1*.

Insulin-like growth factor (IGF) type 2 is produced by some sarcomas and may act as an autocrine growth factor and as a motility factor that promotes metastatic spread. IGF-2 stimulates growth through IGF-1 receptors, but its effects on motility are through different receptors. If secreted in large amounts, IGF-2 may produce hypoglycemia (Chap. 49).

## CLASSIFICATION

Approximately 20 different groups of sarcomas are recognized on the basis of the pattern of differentiation toward normal tissue. For example, rhabdomyosarcoma shows evidence of skeletal muscle fibers with cross-striations; leiomyosarcomas contain interlacing fascicles of spindle cells resembling smooth muscle; and liposarcomas contain adipocytes. When precise characterization of the group is not possible, the tumors are called *unclassified sarcomas*. All of the primary bone sarcomas can also arise from soft tissues (e.g., extraskelatal osteosarcoma). The entity *malignant fibrous histiocytoma* includes many tumors previously classified as fibrosarcomas or as pleomorphic variants of other sarcomas and is characterized by a mixture of spindle (fibrous) cells and round (histiocytic) cells arranged in a storiform pattern with frequent giant cells and areas of pleomorphism.

For purposes of treatment, most soft tissue sarcomas can be considered together. However, some specific tumors have distinct features. For example, *liposarcoma* can have a spectrum of behaviors. Pleomorphic liposarcomas and dedifferentiated liposarcomas behave like other high-grade sarcomas; in contrast, well-differentiated liposarcomas (better termed *atypical lipomatous tumors*) lack metastatic potential, and myxoid liposarcomas metastasize infrequently but, when they do, have a predilection for unusual metastatic sites containing fat, such as the retroperitoneum, mediastinum, and subcutaneous tissue. Rhabdomyosarcomas, Ewing's sarcoma, and other small-cell sarcomas tend to be more aggressive and are more responsive to chemotherapy than other soft tissue sarcomas.

Gastrointestinal stromal cell tumors (GISTs), previously classified as gastrointestinal leiomyosarcomas, are now recognized as a distinct entity within soft tissue sarcomas. Its cell of origin resembles the interstitial cell of Cajal, which controls peristalsis. Most malignant GISTs have activating mutations of the *c-kit* gene that result in ligand-independent phosphorylation and activation of the KIT receptor tyrosine kinase, leading to tumorigenesis.

## DIAGNOSIS

The most common presentation is an asymptomatic mass. Mechanical symptoms referable to pressure, traction, or entrapment of nerves or muscles may be present. All new and persistent or growing masses should be biopsied, either by a cutting needle (core-needle biopsy) or by a small incision, placed so that it can be encompassed in the subsequent excision without compromising a definitive resection. Lymph node metastases occur in 5%, except in synovial and epithelioid sarcomas, clear-cell sarcoma (melanoma of the soft parts), angiosarcoma, and rhabdomyosarcoma, where

542 nodal spread may be seen in 17%. The pulmonary parenchyma is the most common site of metastases. Exceptions are GISTs, which metastasize to the liver; myxoid liposarcomas, which seek fatty tissue; and clear-cell sarcomas, which may metastasize to bones. Central nervous system metastases are rare, except in alveolar soft part sarcoma.

**Radiographic Evaluation**

Imaging of the primary tumor is best with plain radiographs and MRI for tumors of the extremities or head and neck and by CT for tumors of the chest, abdomen, or retroperitoneal cavity. A radiograph and CT scan of the chest are important for the detection of lung metastases. Other imaging studies may be indicated, depending on the symptoms, signs, or histology.

**STAGING AND PROGNOSIS**

The histologic grade, relationship to fascial planes, and size of the primary tumor are the most important prognostic factors. The current American Joint Commission on Cancer (AJCC) staging system is shown in **Table 42-1**. Prognosis is related to the stage. Cure is common in the absence of metastatic disease, but a small number of patients with metastases can also be cured. Most patients with stage IV disease die within 12 months, but some patients may live with slowly progressive disease for many years.

**Rx Treatment: SOFT TISSUE SARCOMAS**

AJCC stage I patients are adequately treated with surgery alone. Stage II patients are considered for adjuvant radiation therapy. Stage III patients may benefit from adjuvant chemotherapy. Stage IV patients are managed primarily with chemotherapy, with or without other modalities.

**SURGERY** Soft tissue sarcomas tend to grow along fascial planes, with the surrounding soft tissues compressed to form a pseudocapsule that gives the sarcoma the appearance of a well-encapsulated lesion. This is invariably deceptive because “shelling out,” or marginal excision, of such lesions results in a 50–90% probability of local recurrence. Wide excision with a negative margin, incorporating the biopsy site, is the standard surgical procedure for local disease. The adjuvant use of radiation therapy and/or chemotherapy improves the local control rate and permits the use of limb-sparing surgery with a local control rate (85–90%) comparable to that achieved by radical excisions and amputations. Limb-sparing approaches are indicated except when negative margins are not obtainable, when the risks of radiation are prohibitive, or when neurovascular structures are involved so that resection will result in serious functional consequences to the limb.

**RADIATION THERAPY** External beam radiation therapy is an adjuvant to limb-sparing surgery for improved local control. Preoperative radiation therapy allows the

**TABLE 42-1**  
**AJCC STAGING SYSTEM FOR SARCOMAS**

HISTOLOGIC GRADE (G)	TUMOR SIZE (T)	NODE STATUS (N)	METASTASES (M)
Well differentiated (G1)	≤5 cm (T1)	Not involved (N0)	Absent (M0)
Moderately differentiated (G2)	>5 cm (T2)	Involved (N1)	Present (M1)
Poorly differentiated (G3)	Superficial fascial involvement (Ta)		
Undifferentiated (G4)	Deep fascial involvement (Tb)		

DISEASE STAGE	5-YEAR SURVIVAL, %
Stage I A: G1,2; T1a,b; N0; M0 B: G1,2; T2a; N0; M0	98.8
Stage II A: G1,2; T2b; N0; M0 B: G3,4; T1; N0; M0 C: G3,4; T2a; N0; M0	81.8
Stage III G3,4; T2b; N0; M0	51.7
Stage IV A: any G; any T; N1; M0 B: any G; any T; any N; M1	<20

use of smaller fields and smaller doses but results in a higher rate of wound complications. Postoperative radiation therapy must be given to larger fields because the entire surgical bed must be encompassed, and in higher doses to compensate for hypoxia in the operated field. Brachytherapy or interstitial therapy, in which the radiation source is inserted into the tumor bed, is comparable in efficacy (except in low-grade lesions), less time-consuming, and less expensive.

**ADJUVANT CHEMOTHERAPY** Chemotherapy is the mainstay of treatment for Ewing's primitive neuroectodermal tumors (PNETs) and rhabdomyosarcomas. Meta-analysis of 14 randomized trials revealed a significant improvement in local control and disease-free survival in favor of doxorubicin-based chemotherapy. Overall survival improvement was 4% for all sites and 7% for the extremity site. A chemotherapy regimen including an anthracycline and ifosfamide with growth factor support improved overall survival by 19% for high-risk (high-grade,  $\geq 5$  cm primary, or locally recurrent) extremity soft tissue sarcomas.

**ADVANCED DISEASE** Metastatic soft tissue sarcomas are largely incurable, but up to 20% of patients who achieve a complete response become long-term survivors. The therapeutic intent, therefore, is to produce a complete remission with chemotherapy (<10%) and/or surgery (30–40%). Surgical resection of metastases, whenever possible, is an integral part of the management. Some patients benefit from repeated surgical excision of metastases. The two most active chemotherapeutic agents are doxorubicin and ifosfamide. These drugs show a steep dose-response relationship in sarcomas. Gemcitabine with or without docetaxel has become an established second-line regimen and is particularly active in patients with leiomyosarcomas. Dacarbazine also has some modest activity. Taxanes have selective activity in angiosarcomas, and vincristine, etoposide, and irinotecan are effective in rhabdomyosarcomas and Ewing's sarcomas. Imatinib mesylate targets the KIT tyrosine kinase activity and is standard therapy for advanced/metastatic GISTs.

## BONE SARCOMAS

### INCIDENCE AND EPIDEMIOLOGY

Bone sarcomas are rarer than soft tissue sarcomas; they accounted for only 0.2% of all new malignancies and 2370 new cases in the United States in 2007. Several benign bone lesions have the potential for malignant transformation. Enchondromas and osteochondromas can transform into chondrosarcoma; fibrous dysplasia, bone infarcts, and Paget's disease of bone can transform into either malignant fibrous histiocytoma or osteosarcoma.

## CLASSIFICATION

### Benign Tumors

The common benign bone tumors include enchondroma, osteochondroma, chondroblastoma, and chondromyxoid fibroma, of cartilage origin; osteoid osteoma and osteoblastoma, of bone origin; fibroma and desmoplastic fibroma, of fibrous tissue origin; hemangioma, of vascular origin; and giant cell tumor, of unknown origin.

### Malignant Tumors

The most common malignant tumors of bone are plasma cell tumors (Chap. 16). The four most common malignant nonhematopoietic bone tumors are osteosarcoma, chondrosarcoma, Ewing's sarcoma, and malignant fibrous histiocytoma. Rare malignant tumors include chordoma (of notochordal origin), malignant giant cell tumor and adamantinoma (of unknown origin), and hemangioendothelioma (of vascular origin).

### Musculoskeletal Tumor Society Staging System

Sarcomas of bone are staged according to the Musculoskeletal Tumor Society staging system based on grade and compartmental localization. A Roman numeral reflects the tumor grade: stage I is low grade, stage II is high grade, and stage III includes tumors of any grade that have lymph node or distant metastases. In addition, the tumor is given a letter reflecting its compartmental localization. Tumors designated A are intracompartmental (i.e., confined to the same soft tissue compartment as the initial tumor), and tumors designated B are extracompartmental (i.e., extending into the adjacent soft tissue compartment or into bone). The tumor node metastasis (TNM) staging system is shown in [Table 42-2](#).

## OSTEOSARCOMA

Osteosarcoma, accounting for almost 45% of all bone sarcomas, is a spindle cell neoplasm that produces osteoid (unmineralized bone) or bone. About 60% of all osteosarcomas occur in children and adolescents in the second decade of life, and ~10% occur in the third decade of life. Osteosarcomas in the fifth and sixth decades of life are frequently secondary to either radiation therapy or transformation in a preexisting benign condition, such as Paget's disease. Males are affected 1.5–2 times as often as females. Osteosarcoma has a predilection for metaphyses of long bones; the most common sites of involvement are the distal femur, proximal tibia, and proximal humerus. The classification of osteosarcoma is complex, but 75% of osteosarcomas fall in the "classic" category, which include osteoblastic, chondroblastic, and fibroblastic osteosarcomas.



## STAGING SYSTEM FOR BONE SARCOMAS

Primary tumor (T)	TX	Primary tumor cannot be assessed
	T0	No evidence of primary tumor
	T1	Tumor $\leq$ 8 cm in greatest dimension
	T2	Tumor $>$ 8 cm in greatest dimension
	T3	Discontinuous tumors in the primary bone site
Regional lymph nodes (N)	NX	Regional lymph nodes cannot be assessed
	N0	No regional lymph node metastasis
	N1	Regional lymph node metastasis
Distant metastasis (M)	MX	Distant metastasis cannot be assessed
	M0	No distant metastasis
	M1	Distant metastasis
	M1a	Lung
	M1b	Other distant sites
Histologic grade (G)	GX	Grade cannot be assessed
	G1	Well differentiated—low grade
	G2	Moderately differentiated—low grade
	G3	Poorly differentiated—high grade
	G4	Undifferentiated—high grade (Ewing's is always classed G4)

## Stage Grouping

Stage IA	T1	N0	M0	G1,2 low grade
Stage IB	T2	N0	M0	G1,2 low grade
Stage IIA	T1	N0	M0	G3,4 high grade
Stage IIB	T2	N0	M0	G3,4 high grade
Stage III	T3	N0	M0	Any G
Stage IVA	Any T	N0	M1a	Any G
Stage IVB	Any T	N1	Any M	Any G
	Any T	Any N	M1b	Any G

The remaining 25% are classified as “variants” on the basis of (1) clinical characteristics, as in the case of osteosarcoma of the jaw, postradiation osteosarcoma, or Paget's osteosarcoma; (2) morphologic characteristics, as in the case of telangiectatic osteosarcoma, small cell osteosarcoma, or epithelioid osteosarcoma; or (3) location, as in parosteal or periosteal osteosarcoma. Diagnosis usually requires a synthesis of clinical, radiologic, and pathologic features. Patients typically present with pain and swelling of the affected area. A plain radiograph reveals a destructive lesion with a moth-eaten appearance, a spiculated periosteal reaction (sunburst appearance), and a cuff of periosteal new bone formation at the margin of the soft tissue mass (Codman's triangle). A

CT scan of the primary tumor is best for defining bone destruction and the pattern of calcification, whereas MRI is better for defining intramedullary and soft tissue extension. A chest radiograph and CT scan are used to detect lung metastases. Metastases to the bony skeleton should be imaged by a bone scan. Almost all osteosarcomas are hypervascular. Angiography is not helpful for diagnosis, but it is the most sensitive test for assessing the response to preoperative chemotherapy. Pathologic diagnosis is established either with a core-needle biopsy, where feasible, or with an open biopsy with an appropriately placed incision that does not compromise future limb-sparing resection. Most osteosarcomas are high grade. The most important prognostic factor for long-term survival is response to chemotherapy. Preoperative chemotherapy followed by limb-sparing surgery (which can be accomplished in  $>$ 80% of patients) followed by postoperative chemotherapy is standard management. The effective drugs are doxorubicin, ifosfamide, cisplatin, and high-dose methotrexate with leucovorin rescue. The various combinations of these agents that have been used have all been about equally successful. Long-term survival rates in extremity osteosarcoma range from 60–80%. Osteosarcoma is radioresistant; radiation therapy has no role in the routine management. Malignant fibrous histiocytoma is considered a part of the spectrum of osteosarcoma and is managed similarly.

## CHONDROSARCOMA

Chondrosarcoma, which constitutes ~20–25% of all bone sarcomas, is a tumor of adulthood and old age with a peak incidence in the fourth to sixth decades of life. It has a predilection for the flat bones, especially the shoulder and pelvic girdles, but can also affect the diaphyseal portions of long bones. Chondrosarcomas can arise de novo or as a malignant transformation of an enchondroma or, rarely, of the cartilaginous cap of an osteochondroma. Chondrosarcomas have an indolent natural history and typically present as pain and swelling. Radiographically, the lesion may have a lobular appearance with mottled or punctate or annular calcification of the cartilaginous matrix. It is difficult to distinguish low-grade chondrosarcoma from benign lesions by x-ray or histologic examination. The diagnosis is therefore influenced by clinical history and physical examination. A new onset of pain, signs of inflammation, and progressive increase in the size of the mass suggest malignancy. The histologic classification is complex, but most tumors fall within the classic category. Like other bone sarcomas, high-grade chondrosarcomas spread to the lungs. Most chondrosarcomas are resistant to chemotherapy, and surgical resection of primary or recurrent tumors, including pulmonary metastases, is the mainstay of therapy. This rule does not hold for two histologic variants. Dedifferentiated chondrosarcoma has a

high-grade osteosarcoma or a malignant fibrous histiocytoma component that responds to chemotherapy. Mesenchymal chondrosarcoma, a rare variant composed of a small cell element, also is responsive to systemic chemotherapy and is treated like Ewing's sarcoma.

## EWING'S SARCOMA

Ewing's sarcoma, which constitutes ~10–15% of all bone sarcomas, is common in adolescence and has a peak incidence in the second decade of life. It typically involves the diaphyseal region of long bones and also has an affinity for flat bones. The plain radiograph may show a characteristic “onion peel” periosteal reaction with a generous soft tissue mass, which is better demonstrated by CT or MRI. This mass is composed of sheets of monotonous, small, round, blue cells and can be confused with lymphoma, embryonal rhabdomyosarcoma, and small-cell carcinoma. The presence of p30/32, the product of the *mic-2* gene (which maps to the pseudoautosomal region of the X and Y chromosomes) is a cell-surface marker for Ewing's sarcoma (and other members of a family of tumors called PNETs). Most PNETs arise in soft tissues; they include peripheral neuroepithelioma, Askin's tumor (chest wall), and esthesioneuroblastoma. Glycogen-filled cytoplasm detected by staining with periodic acid–Schiff is also characteristic of Ewing's sarcoma cells. The classic cytogenetic abnormality associated with this disease (and other PNETs) is a reciprocal translocation of the long arms of chromosomes 11 and 22, t(11;22), which creates a chimeric gene product of unknown function with components from the *fli-1* gene on chromosome 11 and *ews* on 22. This disease is very aggressive, and it is therefore considered a systemic disease. Common sites of metastases are lung, bones, and bone marrow. Systemic chemotherapy is the mainstay of therapy, often used before surgery. Doxorubicin, cyclophosphamide or ifosfamide, etoposide, vincristine, and dactinomycin are active drugs. Local treatment for the primary tumor includes surgical resection, usually with limb salvage or radiation therapy. Patients with lesions below the elbow and below the midcalf have a 5-year survival rate of 80% with effective treatment. Ewing's sarcoma is a curable tumor, even in the presence of obvious metastatic disease, especially in children <11 years old.

## TUMORS METASTATIC TO BONE

Bone is a common site of metastasis for carcinomas of the prostate, breast, lung, kidney, bladder, and thyroid and for lymphomas and sarcomas. Prostate, breast, and lung primaries account for 80% of all bone metastases. Metastatic tumors of bone are more common than primary bone tumors. Tumors usually spread to bone

hematogenously, but local invasion from soft tissue masses also occurs. In descending order of frequency, the sites most often involved are the vertebrae, proximal femur, pelvis, ribs, sternum, proximal humerus, and skull. Bone metastases may be asymptomatic or may produce pain, swelling, nerve root or spinal cord compression, pathologic fracture, or myelophthisis (replacement of the marrow). Symptoms of hypercalcemia may be noted in cases of bony destruction.

Pain is the most frequent symptom. It usually develops gradually over weeks, is usually localized, and often is more severe at night. When patients with back pain develop neurologic signs or symptoms, emergency evaluation for spinal cord compression is indicated (Chap. 51). Bone metastases exert a major adverse effect on quality of life in cancer patients.

Cancer in the bone may produce osteolysis, osteogenesis, or both. Osteolytic lesions result when the tumor produces substances that can directly elicit bone resorption (vitamin D–like steroids, prostaglandins, or parathyroid hormone–related peptide) or cytokines that can induce the formation of osteoclasts (interleukin 1 and tumor necrosis factor). Osteoblastic lesions result when the tumor produces cytokines that activate osteoblasts. In general, purely osteolytic lesions are best detected by plain radiography, but they may not be apparent until they are >1 cm. These lesions are more commonly associated with hypercalcemia and with the excretion of hydroxyproline-containing peptides indicative of matrix destruction. When osteoblastic activity is prominent, the lesions may be readily detected using radionuclide bone scanning (which is sensitive to new bone formation), and the radiographic appearance may show increased bone density or sclerosis. Osteoblastic lesions are associated with higher serum levels of alkaline phosphatase and, if extensive, may produce hypocalcemia. Although some tumors may produce mainly osteolytic lesions (e.g., kidney cancer) and others mainly osteoblastic lesions (e.g., prostate cancer), most metastatic lesions produce both types of lesion and may go through stages where one or the other predominates.

In older patients, particularly women, it may be necessary to distinguish metastatic disease of the spine from osteoporosis. In osteoporosis, the cortical bone may be preserved, whereas cortical bone destruction is usually noted with metastatic cancer.

### **Rx Treatment:** **METASTATIC BONE DISEASE**

Treatment of metastatic bone disease depends on the underlying malignancy and the symptoms. Some metastatic bone tumors are curable (lymphoma, Hodgkin's disease), and others are treated with palliative intent. Pain may be relieved by local radiation therapy.

Hormonally responsive tumors are responsive to hormone inhibition (antiandrogens for prostate cancer, antiestrogens for breast cancer). Strontium 89 and samarium 153 are bone-seeking radionuclides that can exert antitumor effects and relieve symptoms. Bisphosphonates such as pamidronate may relieve pain and inhibit bone resorption, thereby maintaining bone mineral density and reducing risk of fractures in patients with osteolytic metastases from breast cancer and multiple myeloma. Careful monitoring of serum electrolytes and creatinine is recommended. Monthly administration prevents bone-related clinical events and may reduce the incidence of bone metastases in women with breast cancer. When the integrity of a weight-bearing bone is threatened by an expanding metastatic lesion that is refractory to radiation therapy, prophylactic internal fixation is indicated. Overall survival is related to the prognosis of the underlying tumor. Bone pain at the end of life is particularly common; an adequate pain relief regimen including sufficient amounts of narcotic analgesics is required.

## FURTHER READINGS

- BORDEN EC et al: Soft tissue sarcomas of adults: State of the translational science. *Clin Cancer Res* 9:1941, 2003
- DIEMEL KD et al: Pulmonary metastasectomy for osteosarcoma: Is it justified? *Recent Results Cancer Res* 179:183, 2009
- HELMAN LJ, MELTZER P: Mechanisms of sarcoma development. *Nat Rev Cancer* 3:685, 2003
- JANSEN-LANDHEER ML et al: Improved diagnosis and treatment of soft tissue sarcoma patients after implementation of national guidelines: a population-based study. *Eur J Surg Oncol* 2009; June 12 (Epub ahead of print)
- MOCELLIN S et al: Adult soft tissue sarcomas: Conventional therapies and molecularly targeted approaches. *Cancer Treat Rev* 32:9, 2006
- O'DAY K, GORLICK R: Novel therapeutic agents for osteosarcoma. *Expert Rev Anticancer Ther* 9:511, 2009
- PISTERS PW et al: Evidence-based recommendations for local therapy for soft tissue sarcomas. *J Clin Oncol* 25:1003, 2007
- SCURR M, JUDSON I: How to treat the Ewing's family of sarcomas in adult patients. *Oncologist* 11:65, 2006
- VERWEIJ J: Soft tissue sarcoma trials: One size no longer fits all. *J Clin Oncol* 27:3085, 2009
- et al: Progression-free survival in gastrointestinal stromal tumors with high-dose imatinib: Randomized trial. *Lancet* 364:1127, 2004



## CHAPTER 43

# PRIMARY AND METASTATIC TUMORS OF THE NERVOUS SYSTEM

Stephen M. Sagar ■ Mark A. Israel

■ Primary Brain Tumors . . . . .	.548	Tuberous Sclerosis (Bourneville's Disease) . . . . .	.556
Etiology . . . . .	.548	Von Hippel–Lindau Syndrome . . . . .	.556
Astrocytomas . . . . .	.549	■ Tumors Metastatic to Brain . . . . .	.556
Oligodendrogliomas . . . . .	.551	Mechanisms of Brain Metastases . . . . .	.556
Ependymomas . . . . .	.552	Evaluation of Metastases from Known Cancer . . . . .	.557
Medulloblastomas and Primitive Neuroectodermal Tumors (PNET) . . . . .	.552	Brain Metastases without a Known Primary Tumor . . . . .	.557
CNS Lymphoma . . . . .	.553	■ Leptomeningeal Metastases . . . . .	.558
Meningiomas . . . . .	.554	Clinical Features . . . . .	.558
Schwannomas . . . . .	.554	Laboratory and Imaging Evaluation . . . . .	.559
Other Benign Brain Tumors . . . . .	.555	■ Malignant Spinal Cord Compression . . . . .	.559
■ Neurocutaneous Syndromes . . . . .	.555	■ Metastases to the Peripheral Nervous System . . . . .	.559
Neurofibromatosis Type 1 (Von Recklinghausen's Disease) . . . . .	.556	■ Complications of Therapy . . . . .	.560
Neurofibromatosis Type 2 . . . . .	.556	Radiation Toxicity . . . . .	.560
		Toxicities of Chemotherapy . . . . .	.561
		■ Further Readings . . . . .	.561

Malignant primary tumors of the central nervous system (CNS) occur in ~16,500 individuals and account for an estimated 13,000 deaths in the United States annually, a mortality rate of 6 per 100,000. The age-adjusted incidence appears to be about the same worldwide. An approximately equal number of benign tumors of the CNS are diagnosed, with a much lower mortality rate. Glial tumors account for 50–60% of primary brain tumors, meningiomas for 25%, schwannomas for 10%, and other CNS tumors for the remainder.

Brain and vertebral metastases from systemic cancer are far more prevalent than primary CNS tumors. About 15% of patients who die of cancer (80,000 individuals each year in the United States) have symptomatic brain metastases; an additional 5% suffer spinal cord involvement. Brain and spinal metastases therefore pose a major problem in the management of systemic cancer.

### Approach to the Patient: BRAIN TUMORS

**CLINICAL FEATURES** Brain tumors usually present with one of three syndromes: (1) subacute progression of a focal neurologic deficit; (2) seizure; or (3) nonfocal neurologic disorder such as headache, dementia, personality change, or gait disorder. The presence of systemic symptoms such as malaise, weight loss, anorexia, or fever suggests a metastatic rather than a primary brain tumor.

Progressive focal neurologic deficits result from compression of neurons and white matter tracts by expanding tumor and surrounding edema. Less commonly, a brain tumor presents with a sudden stroke-like onset of a focal neurologic deficit. Although this presentation may be caused by hemorrhage into the tumor, often no hemorrhage can be demonstrated and the mechanism is obscure. Tumors frequently

associated with hemorrhage include high-grade gliomas, metastatic melanoma, and choriocarcinoma.

Seizures may result from disruption of cortical circuits. Tumors that invade or compress the cerebral cortex, even small meningiomas, are more likely to be associated with seizures than subcortical neoplasms. Nonfocal neurologic dysfunction usually reflects increased intracranial pressure (ICP), hydrocephalus, or diffuse tumor spread. Tumors in some areas of the brain may produce behavioral disorders; for example, frontal lobe tumors may present with personality change, dementia, or depression.

Headache may result from focal irritation or displacement of pain-sensitive structures or from a generalized increase in ICP. A headache that worsens rather than abates with recumbency is suggestive of a mass lesion. Headaches from increased ICP are usually holocephalic and episodic, occurring more than once a day. They typically develop rapidly over several minutes, persist for 20–40 min, and subside quickly. They may awaken the patient from a sound sleep, generally 60–90 min after retiring. Vomiting may occur with severe headaches. As elevated ICP becomes sustained, the headache becomes continuous but varying in intensity. Elevated ICP may cause papilledema, although it is often not present in infants or patients >55 years of age.

The Karnofsky performance scale is useful in assessing patients with brain tumors (Chap. 25). A score  $\geq 70$  indicates that the patient is ambulatory and independent in self-care activities; it is often taken as a level of function justifying aggressive therapy.

**NEUROIMAGING** CT and MRI can reveal mass effect and contrast enhancement. Mass effect reflects the volume of neoplastic tissue as well as surrounding edema. Brain tumors typically produce a vasogenic pattern of edema, with accumulation of excess water in surrounding white matter. Contrast enhancement reflects a breakdown of the blood-brain barrier within the tumor, permitting leakage of contrast agent. Low-grade gliomas typically do not exhibit contrast enhancement.

Positron emission tomography (PET) and single-photon emission tomography (SPECT) have ancillary roles in the imaging of brain tumors, primarily in distinguishing tumor recurrence from tissue necrosis that can occur after irradiation (see later). Functional imaging with PET, MRI, or magnetoencephalography may be of use in surgical or radiosurgical planning to define the anatomic relationship of the tumor to critical brain regions such as the primary motor or language cortex.

**LABORATORY EXAMINATION** Primary brain tumors typically do not produce serologic abnormalities such as an elevated sedimentation rate or tumor-specific

antigens. In contrast, metastases to the nervous system, depending on the type and extent of the primary tumor, may be associated with systemic signs of malignancy (Chap. 25). Lumbar puncture is generally not useful in the diagnosis of brain tumors. The cerebrospinal fluid (CSF) rarely contains malignant cells, with the important exceptions of leptomeningeal metastases; primary CNS lymphoma; and primitive neuroectodermal tumors, including medulloblastoma. The primary use of lumbar puncture in the evaluation of a brain tumor is to exclude other diagnoses, such as infection or demyelinating disease. Moreover, lumbar puncture may precipitate brain herniation in patients with mass lesions and should be performed only in patients in whom imaging studies have demonstrated the basilar cisterns to be patent.

## **Rx** Treatment: BRAIN TUMORS

**SYMPTOMATIC** Glucocorticoids decrease the volume of edema surrounding brain tumors and improve neurologic function; dexamethasone (initially 12–20 mg/d in divided doses PO or IV) is used because it has relatively little mineralocorticoid activity. Because of the toxicities of long-term glucocorticoid administration, the dexamethasone dose is rapidly tapered to the lowest dose that relieves symptoms.

The treatment of epilepsy associated with brain tumors is identical to the treatment of other forms of partial epilepsy. The first-line agents phenytoin, carbamazepine, and valproic acid are equally effective; levetiracetam and oxcarbazepine are also coming into wide use. It is common practice to administer anti-epileptic drugs prophylactically to all patients with supratentorial brain tumors, although there are no good data supporting this practice.

Gliomas and primary CNS lymphomas are associated with an increased risk for deep vein thrombosis and pulmonary embolism, probably because these tumors secrete procoagulant factors into the systemic circulation. Even though hemorrhage within gliomas is a frequent histopathologic finding, patients are at no increased risk for symptomatic intracranial bleeding following treatment with an anticoagulant. Prophylaxis with low-dose SC heparin should be employed for patients with brain tumors who have lower limb immobility, which places them at risk for deep venous thrombosis.

## PRIMARY BRAIN TUMORS

### ETIOLOGY

Exposure to ionizing radiation is the only well-documented environmental risk factor for the development of gliomas. A number of hereditary syndromes are associated with

TABLE 43-1

HEREDITARY SYNDROMES ASSOCIATED WITH BRAIN TUMORS			
SYNDROME	GENE (LOCUS)	GENE PRODUCT (FUNCTION)	NERVOUS SYSTEM NEOPLASMS
Neurofibromatosis type 1 (von Recklinghausen's Disease) <sup>a</sup>	<i>NF1</i> (17q)	Neurofibromin (GTPase activating protein)	Neuroma, schwannoma, meningioma, optic glioma
Neurofibromatosis type 2 <sup>a</sup>	<i>NF2</i> (22q)	Merlin (cytoskeletal protein)	Schwannoma, glioma, ependymoma, meningioma
Tuberous sclerosis	<i>TSC1</i> (9q) <i>TSC2</i> (16p)	Hamartin (unknown function) Tuberin (GTPase activating protein)	Astrocytoma
von Hippel-Lindau <sup>a</sup>	<i>VHL</i> (3p)	pVHL (modulator of cellular hypoxic response)	Hemangioblastoma of retina, cerebellum and spinal cord; pheochromocytoma
Li-Fraumeni <sup>a</sup>	<i>p53</i> (17p)	TP53 (cell cycle and transcriptional regulator)	Malignant glioma
Retinoblastoma <sup>a</sup>	<i>RB1</i> (13q)	RB (cell cycle regulator)	Retinoblastoma, pineoblastoma, malignant glioma
Turcot	<i>APC</i> (5q) (adenomatous polyposis coli)	APC (cell adhesion)	Medulloblastoma, malignant glioma
Gorlin (basal cell nevus syndrome)	<i>PTCH</i> (9q) (patched)	PTH (developmental regulator)	Medulloblastoma
Multiple endocrine neoplasia 1 (Werner syndrome) <sup>a</sup>	<i>MEN1</i> (11q13)	Menin (cofactor for transcription)	Pituitary adenoma, malignant schwannoma

<sup>a</sup>Genetic testing possible.

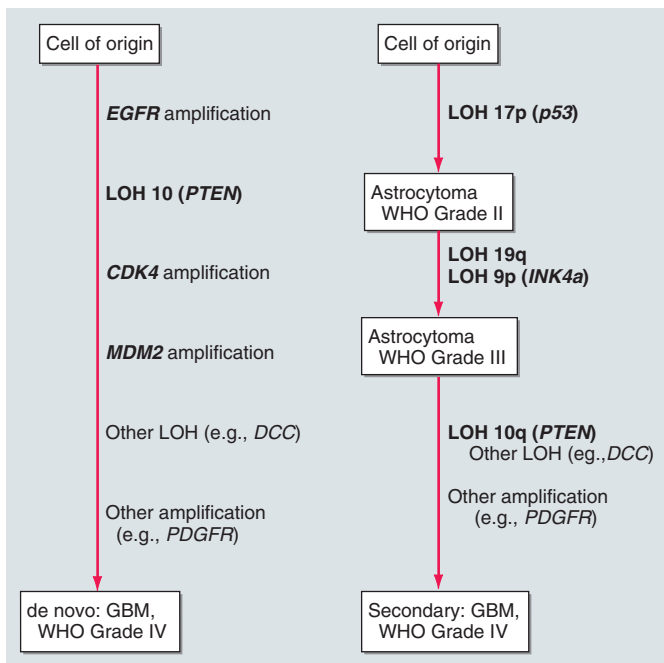
an increased risk of brain tumors (Table 43-1). Genes that contribute to the development of brain tumors, as well as other malignancies, fall into two general classes, *tumor-suppressor genes* and *oncogenes* (Chap. 23). Whereas germline mutations of such genes do occur in patients with hereditary predisposition syndromes (Table 43-1), most brain tumors do not occur in patients with such recognizable syndromes. As is the case in all other tumor types, somatic mutations are almost invariably present in malignant brain tumor tissue. Amplification of the *EGFR* gene occurs in approximately a third of cases of glioblastoma multiforme (GBM), the highest grade astrocytoma. Moreover, cytogenetic analysis often reveals characteristic changes that can signal the alteration in cancer-related genes within these chromosomal regions. In astrocytic tumors, DNA is commonly lost on chromosomes 10p, 17p, 13q, and 9. Oligodendrogliomas frequently have deletions of 1p and 19q, resulting from a centromeric translocation and loss of one of the translocated chromosomes. In meningiomas, portions of 22q, which contains the gene for neurofibromatosis (NF) type 2, are often lost.

The particular constellation of genetic alterations varies among individual gliomas, even those that are histologically indistinguishable. Moreover, gliomas are genetically unstable. Genetic abnormalities tend to accumulate with time, and these changes correspond with an increasingly malignant phenotype. There are at least two

genetic routes for the development of GBM (Fig. 43-1). One route involves the progression, generally over years, from a low-grade astrocytoma with deletions of chromosome 17 and inactivation of the *p53* gene to a highly malignant glioma with additional chromosomal alterations. The second route is characterized by the de novo appearance of a malignant glioma with amplification of the *EGFR* gene and an intact *p53* gene in association with other genetic abnormalities.

## ASTROCYTOMAS

Tumors with astrocytic cytologic features are the most common primary intracranial neoplasms (Fig. 43-2). The most widely used histologic grading system is the World Health Organization four-tiered grading system. Grade I is reserved for special histologic variants of astrocytoma that occur mainly in childhood and can have an excellent prognosis after surgical excision. These include *juvenile pilocytic astrocytoma*, *subependymal giant cell astrocytoma* (which most often occurs in patients with tuberous sclerosis), and *pleomorphic xanthoastrocytoma*. At the other extreme is grade IV GBM, a clinically aggressive tumor. *Astrocytoma* (grade II) and *anaplastic astrocytoma* (grade III) are intermediate in their histologic and clinical manifestations. The histologic features associated with higher grade are hypercellularity, nuclear and cytoplasmic atypia, endothelial

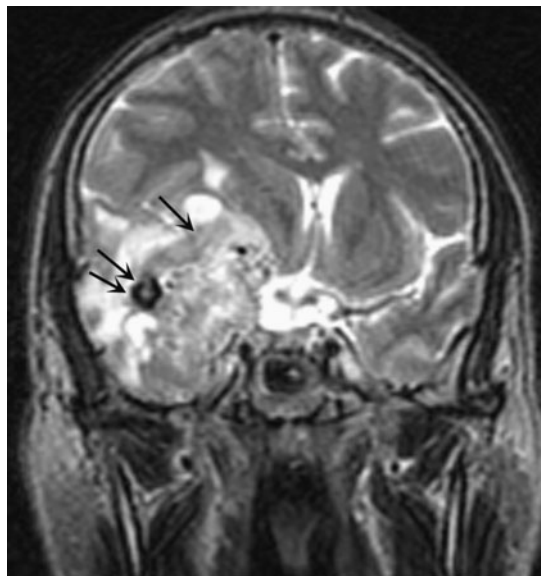
**FIGURE 43-1****Model for the pathogenesis of human astrocytoma.**

Glioblastoma multiforme (GBM) typically presents without evidence of a precursor lesion, referred to as de novo GBM, frequently associated with amplification of the epidermal growth factor receptor (*EGFR*) gene. Less commonly, GBM arises in association with progressive genetic alterations after the diagnosis of a lower grade astrocytoma. These tumors are referred to as secondary GBM. The most widely described alterations are mutations of *p53* and *INK4a*. Other genes implicated in the development of these primary brain tumors include *CDK4*, *MDM2*, *DDC*, and *PDGFR*. LOH, loss of heterozygosity.

proliferation, mitotic activity, and necrosis. Endothelial proliferation and necrosis are strong predictors of aggressive behavior.

Quantitative measures of mitotic activity also correlate with prognosis. The proliferation index can be determined by immunohistochemical staining with antibodies to the proliferating cell nuclear antigen (PCNA) or with a monoclonal antibody termed *Ki-67*, which recognizes a histone protein expressed in proliferating but not quiescent cells.

The prognosis of brain tumor patients is closely associated with the histologic grade of the tumor. In a representative Finnish population, the median survival was 93.5 months for patients with grade I or II astrocytomas, 12.4 months for patients with grade III (anaplastic astrocytoma), and 5.1 months for patients with grade IV (GBM) tumors. Although these survival rates are somewhat lower than are generally reported, they represent a population-based experience and are not influenced by selection bias. Clinical features correlating with poor prognosis include age >65 years and a poor

**FIGURE 43-2****Malignant astrocytoma (glioblastoma).**

Coronal proton density-weighted MR scan through the temporal lobes demonstrates a heterogeneous right temporal lobe mass (arrows) compressing the third and lateral ventricles. The area of hypointense signal (double arrows) indicates either hemorrhage or calcification. Heterogeneous MR signal intensity is typical of glioblastoma.

functional status, as defined by the Karnofsky performance scale.

**Low-Grade Astrocytoma**

Low-grade astrocytomas are more common in children than adults. Pilocytic astrocytoma, named for its characteristic spindle-shaped cells, is the most common childhood brain tumor and typically benign. It frequently occurs in the cerebellum and is well demarcated from adjacent brain. Complete surgical excision usually produces long-term, disease-free survival.

The median overall survival of grade II astrocytoma is 5–6 years. The optimum timing of surgery and radiation therapy for these patients is unknown. Because astrocytomas infiltrate surrounding brain, total surgical excision is impossible. Moreover, they are genetically unstable and accumulate mutations over time, leading to more aggressive behavior. For patients who are symptomatic from mass effect or poorly controlled epilepsy, surgical excision can relieve symptoms. For patients who are asymptomatic or minimally symptomatic at presentation, a diagnostic biopsy should be performed and, when surgically feasible, the tumor may be resected. Whether radiation therapy is administered immediately postoperatively or at the time of tumor progression is not thought to affect overall survival, but immediate radiation therapy does delay tumor progression. No role for chemotherapy in the management of low-grade astrocytoma has been defined.

## High-Grade Astrocytoma

The large majority of astrocytomas arising in adults are high grade, supratentorial, and do not have a clearly defined margin between normal and malignant tissue.

Neoplastic cells migrate away from the main tumor mass and infiltrate adjacent brain, often tracking along white matter pathways. Imaging studies do not indicate the full extent of the tumor. These tumors are almost all eventually fatal. Median survival of patients with grade III astrocytoma is <3 years and for those with a grade IV tumor, <1 year. Longer survival correlates with younger age, better performance status, and greater extent of surgical resection. Late in their course, astrocytomas, especially those located in the posterior fossa, can metastasize along CSF pathways to the spine. Metastases outside the CNS are rare.

High-grade astrocytomas are managed with glucocorticoids, surgery, radiation therapy, and chemotherapy. Dexamethasone is generally administered at the time of diagnosis and continued for the duration of radiation therapy. After completion of radiation therapy, dexamethasone is tapered to the lowest possible dose.

Because astrocytomas infiltrate adjacent normal brain, total surgical excision is not possible. Nevertheless, retrospective studies indicate that the extent of tumor resection correlates with survival in younger patients. Therefore, accessible astrocytomas are generally resected aggressively. Surgery is indicated to obtain tissue for pathologic diagnosis and to control mass effect.

Postoperative radiation therapy prolongs survival and improves quality of life. Treated with dexamethasone alone following surgery, the mean survival of patients <65 years with glioblastoma is 7–9 months. Survival is prolonged to 11–13 months with radiation therapy. For primary glial tumors, radiation is generally administered to the tumor mass, as defined by contrast enhancement on a CT or MRI scan, plus a 2-cm margin. A total dose of 5000–7000 cGy is administered in 25–35 equal fractions, 5 days per week.

The roles of stereotaxic radiosurgery and interstitial brachytherapy in glioma treatment are uncertain. *Stereotaxic radiosurgery* is the administration of a focused high dose of radiation to a precisely defined volume of tissue in a single treatment. Stereotaxic radiosurgery can potentially achieve tumor ablation within the treated volume. A major limitation of stereotaxic radiosurgery is that it can be used for only relatively small tumors, generally <4 cm in maximum diameter. *Interstitial brachytherapy*, the implantation of radioactive material into the tumor mass, is generally reserved for tumor recurrence because of its associated toxicity, necrosis of adjacent brain tissue.

Chemotherapy is marginally effective and often used as an adjuvant therapy following surgery and radiation therapy. Temozolomide, an orally administered alkylating

agent, has replaced nitrosoureas, including carmustine (BCNU) and lomustine (CCNU), as the most widely used chemotherapeutic agent for high-grade gliomas. Temozolomide is generally better tolerated than nitrosoureas, notably producing less fatigue and pulmonary toxicity, and has the advantage of oral administration. Moreover, a randomized trial of radiation therapy plus temozolomide for the adjuvant treatment of GBM compared to radiation therapy alone was the first clinical trial to demonstrate a clear-cut advantage of adjuvant chemotherapy for that disease. The patients who received radiation therapy plus temozolomide had a median survival 2.5 months longer than those who received radiation therapy alone. The modest survival benefit appears to be restricted to a subgroup of patients with methylation and silencing of the promoter for the *MGMT* gene coding for *O*<sup>6</sup>-methylguanine-DNA methyltransferase.

An alternative approach to the chemotherapy of high-grade gliomas that has shown survival benefit in controlled trials is the surgical implantation directly into the tumor resection cavity of polymer wafers that release BCNU locally into surrounding brain. The efficacy of this approach is similar to but probably slightly less than that of temozolomide, although without the attendant systemic toxicity of chemotherapy.

Experimental approaches to brain tumor chemotherapy include efforts to bypass the blood-brain barrier using local injection of chemotherapeutic agents into the tumor mass or the intraarterial injection of chemotherapy following osmotic disruption of the blood-brain barrier. Molecularly targeted therapies are also being tested in patients with GBM. In particular, because mutation or overexpression of EGFR is common in GBM, EGFR antagonists or inhibitors of its signaling pathways are being evaluated in patients with GBM in clinical trials.

*Gliomatosis cerebri* is a rare form of astrocytoma in which there is diffuse infiltration of the brain by malignant astrocytes without a focal enhancing mass. It generally presents as a multifocal CNS syndrome or a more generalized disorder including dementia, personality change, or seizures. Neuroimaging studies are often nonspecific, and biopsy is required to establish the diagnosis. Gliomatosis cerebri is treated with whole-brain radiation therapy or temozolomide; in selected patients, radiation to the entire neuraxis is employed.

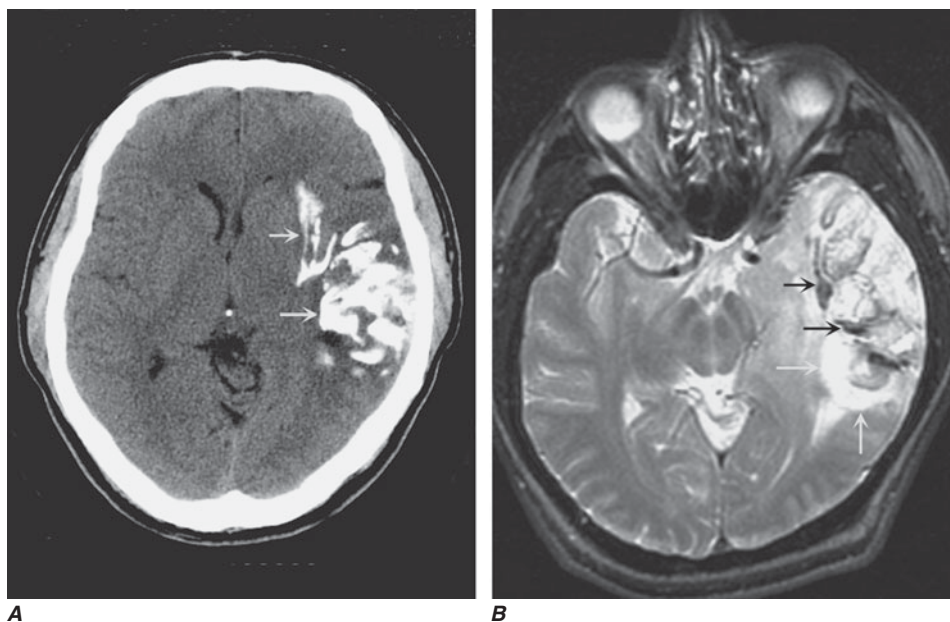
## OLIGODENDROGLIOMAS

Oligodendrogliomas, which comprise ~15% of gliomas in adults, have a more benign course and are more responsive to cytotoxic treatment than astrocytomas. For grade II oligodendrogliomas, the median survival is 7–8 years, and there are a substantial number of patients with prolonged survival (>10 years). For grade III or anaplastic



**FIGURE 43-3**

**Oligodendroglioma.** **A.** Noncontrast CT scan reveals a calcified mass involving the left temporal lobe (arrows) associated with mild mass effect but little edema. **B.** An MR T2-weighted image demonstrates a heterogeneous mass with hypointense signal (black arrows) surrounded by a zone of higher signal intensity (white arrows), consistent with a calcified temporal lobe mass. The tumor extends into the left medial temporal lobe and compresses the midbrain.



oligodendrogliomas, median survival is ~5 years. Oligodendrogliomas occur chiefly in supratentorial locations; in adults, ~30% contain areas of calcification (Fig. 43-3).

As a rule, oligodendrogliomas are less infiltrative than astrocytomas, permitting more complete surgical excision. Histologic features of mitoses, necrosis, and nuclear atypia are associated with a more aggressive clinical course. If these features are prominent, the tumor is termed an *anaplastic oligodendroglioma*. Some gliomas contain mixtures of cells with astrocytic and oligodendroglial features. If this mixed histology is prominent, the tumor is termed a *mixed glioma*, or an *oligoastrocytoma*. The greater the oligodendroglial component, the more benign the clinical course.

Surgery, at minimum a stereotaxic biopsy, is necessary to establish a diagnosis. Many oligodendrogliomas are amenable to gross total surgical resection. In addition, oligodendrogliomas may respond dramatically to systemic combination chemotherapy with procarbazine, lomustine, and vincristine (PCV), or to temozolomide, which, although not approved by the U.S. Food and Drug Administration (FDA) for this indication, is currently much more widely used than PCV. Oligodendrogliomas with deletions of chromosome 1p always respond to chemotherapy, but only ~25% of oligodendrogliomas lacking the 1p deletion respond. The simultaneous deletion of 1p and 19q, which results from a centromeric translocation of chromosomes 1 and 19, predicts a durable response to chemotherapy (>31 months on average) and a much longer survival. It appears that the chromosomal translocation identifies a subgroup of anaplastic oligodendrogliomas with a less aggressive natural course, and response to chemotherapy is another marker of that favorable phenotype.

## EPENDYMOMAS

In adults, the most frequent histologic type is myxopapillary ependymoma, which typically arises from the filum terminale of the spinal cord and appears in the lumbosacral region. The term *myxopapillary* refers to the papillary arrangement of tumor cells, which produce mucin. Ependymomas in adults may also occur intracranially or at higher levels of the spinal cord. On CT or MRI, ependymomas typically appear as diffusely enhancing masses relatively well demarcated from adjacent neural tissue. Following gross total resection, the prognosis is good, with >80% 5-year disease-free survival. Ependymomas that cannot be totally resected are treated with stereotaxic radiosurgery or with a course of external beam radiation therapy.

## MEDULLOBLASTOMAS AND PRIMITIVE NEUROECTODERMAL TUMORS (PNET)

These highly cellular malignant tumors are thought to arise from neural precursor cells. Medulloblastomas occur in the posterior fossa and, along with astrocytomas, are the most frequent malignant brain tumors of children. PNET is a term applied to tumors histologically indistinguishable from medulloblastoma but occurring either in adults or supratentorially in children. In adults, >50% present in the posterior fossa. These tumors frequently disseminate along CSF pathways.

If possible, these tumors should be surgically excised; the less residual tumor left behind, the better the prognosis. In adults, surgical excision of a PNET should be followed by irradiation of the entire neuraxis, with a boost in radiation dose to the primary tumor. If the tumor is not disseminated at presentation, the prognosis

is generally favorable. Aggressive treatment can result in prolonged survival, although half of adult patients relapse within 5 years of treatment. Whereas chemotherapy is widely used in medulloblastoma and PNET in children, its role in adults is not yet defined.

## CNS LYMPHOMA

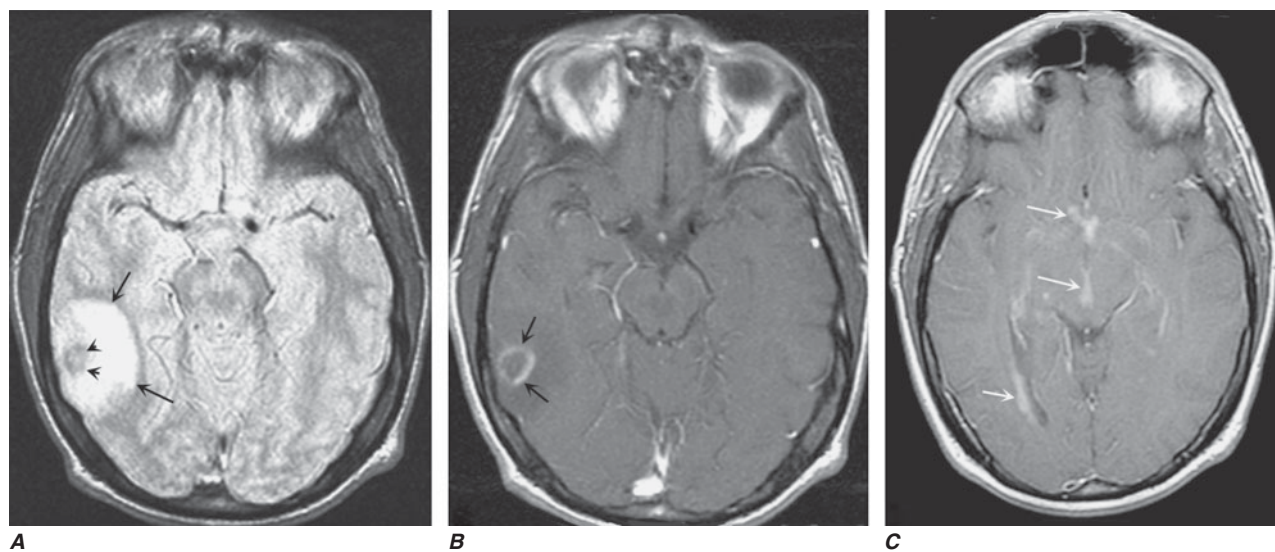
### Primary CNS Lymphoma

Primary CNS lymphoma is typically a high-grade B cell malignancy that presents within the neuraxis without evidence of systemic lymphoma. These occur most frequently in immunocompromised individuals, specifically organ transplant recipients and patients with AIDS. In immunocompromised patients, CNS lymphomas are invariably associated with Epstein-Barr virus infection of the tumor cells.

In immunocompetent patients, neuroimaging studies most often reveal a uniformly enhancing mass lesion. Stereotaxic needle biopsy can be used to establish the diagnosis. There is no benefit of surgical resection unless there is a need for immediate decompression of a life-threatening mass effect. Leptomeningeal involvement is present in ~15% of patients at presentation and in 50% at some time during the course of the illness. Moreover, the disease extends to the eyes in up to 15% of patients. Therefore, a slit-lamp examination and, if indicated, anterior chamber paracentesis or vitreous biopsy is necessary to define radiation ports.

The prognosis of primary CNS lymphoma is poor compared to histologically similar lymphoma occurring outside the CNS. Many patients experience a dramatic clinical and radiographic response to glucocorticoids; however, relapse almost invariably occurs within weeks. The mainstay of definitive therapy is chemotherapy. A single dose of rituximab is generally administered prior to cytotoxic chemotherapy as long as an enhancing mass lacking a blood-tumor barrier is present. Chemotherapy includes high-dose methotrexate, but multiagent chemotherapy, usually adding vincristine and procarbazine, appears to be more effective than methotrexate alone. Chemotherapy is followed in patients <60 years with whole-brain radiation therapy (WBRT). WBRT is postponed as long as possible or administered at reduced doses in patients >60 years because of the risk of dementia, gait disorder, and incontinence as manifestations of late-delayed radiation toxicity. Consolidation therapy is typically with high-dose cytarabine. Intraarterial chemotherapy with or without blood-brain barrier disruption is an alternative. Intrathecal chemotherapy with methotrexate can be added if leptomeningeal disease is present, but it has not proven to offer added benefit if high-dose methotrexate is used. Despite aggressive therapy, >90% of patients develop recurrent CNS disease. The median survival of patients who tolerate treatment with high-dose methotrexate is >3 years.

In immunodeficient patients, primary CNS lymphoma may be ring-enhancing rather than diffusely enhancing on CT or MRI (Fig. 43-4). It may therefore



**FIGURE 43-4**

**CNS lymphoma.** **A.** Proton density-weighted MR image through the temporal lobe demonstrates a low signal intensity nodule (*small arrows*) surrounded by a ring of high signal intensity edema (*larger arrows*). **B.** T1-weighted contrast-enhanced axial MRI demonstrates ring enhancement surrounded by a nonenhanced rim of edema. In this patient with AIDS, a solitary lesion of this type is consistent with either

lymphoma or toxoplasmosis; the presence of multiple lesions favors toxoplasmosis. **C.** In a different patient with lymphomatous meningitis, an axial postcontrast T1-weighted MRI through the midbrain demonstrates multiple areas of abnormal enhancement in periventricular and subependymal regions (*arrows*). Lymphoma tends to spread subependymally at interfaces of CSF and brain parenchyma.

be impossible by imaging criteria to distinguish primary CNS lymphoma from metastatic malignancies or infections, particularly toxoplasmosis. The standard approach to this dilemma in a neurologically stable patient is to administer antibiotics to treat toxoplasmosis for 2–3 weeks and then repeat neuroimaging. If the imaging shows clear improvement, antibiotic treatment is continued. If not, a stereotaxic brain biopsy, which has substantially more risk in an immunodeficient than an immunocompetent patient, is performed. Alternatively, when the clinical situation permits a safe lumbar puncture, a CSF examination demonstrating Epstein-Barr virus DNA in CSF in an immunodeficient patient with neuroimaging findings consistent with lymphoma is diagnostic of primary CNS lymphoma. In organ transplant recipients, reversal of the immunosuppressed state can improve outcome. Survival with AIDS-related primary CNS lymphoma is very poor, generally  $\leq 3$  months; pretreatment performance status, the degree of immunosuppression, and the extent of CNS dissemination at diagnosis all appear to influence outcome.

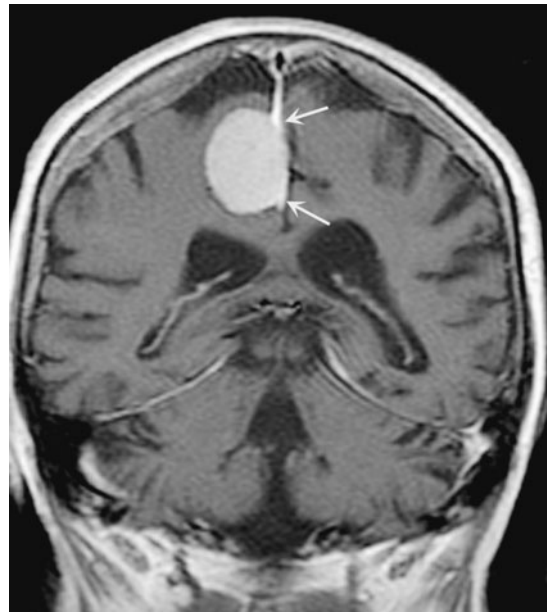
### Secondary CNS Lymphoma

Secondary CNS lymphoma is a manifestation of systemic disease and almost always occurs in adults with progressive B cell lymphoma or B cell leukemia who have tumor involvement of bone, bone marrow, testes, or the cranial sinuses. The leptomeninges are the most common site of CNS metastasis. Leptomeningeal lymphoma is usually detectable with contrast-enhanced CT or gadolinium-enhanced MRI of the brain and spine or by CSF examination. Treatment consists of systemic chemotherapy, intrathecal chemotherapy, and CNS irradiation. It is usually possible to suppress the leptomeningeal disease effectively, although the overall prognosis is determined by the course of the systemic lymphoma. Intraparenchymal lymphoma metastases may be treated with radiation therapy or systemic chemotherapy.

## MENINGIOMAS

Meningiomas are derived from mesoderm, probably from cells giving rise to the arachnoid granulations. These tumors are usually benign and attached to the dura. They may invade the skull but only infrequently invade the brain. Meningiomas most often occur along the sagittal sinus, over the cerebral convexities, in the cerebellar-pontine angle, and along the dorsum of the spinal cord. They are more frequent in women than men, with a peak incidence in middle age.

Meningiomas may be found incidentally on a CT or MRI scan or may present with a focal seizure, a slowly progressive neurologic deficit, or symptoms of raised ICP. The radiologic image of a dural-based, extraaxial mass with dense, uniform contrast enhancement is essentially diagnostic, although a dural metastasis must



**FIGURE 43-5**

**Meningioma.** Coronal postcontrast T1-weighted MR image demonstrates an enhancing extraaxial mass arising from the falx cerebri (arrows). There is a “dural tail” of contrast enhancement extending superiorly along the intrahemispheric septum.

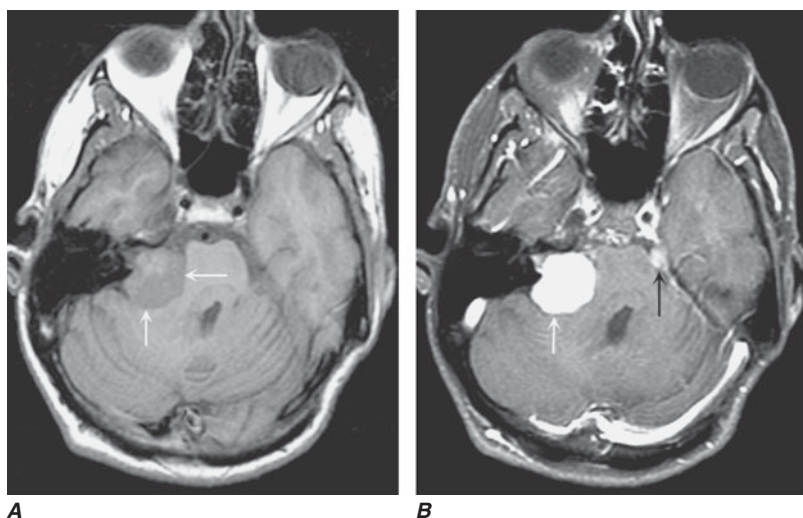
also be considered (Fig. 43-5). A meningioma may have a “dural tail,” a streak of dural enhancement flanking the main tumor mass; however, this finding may also be present with other dural tumors.

Total surgical resection of benign meningiomas is curative. If a total resection cannot be achieved, local external beam radiotherapy or stereotaxic radiosurgery reduces the recurrence rate to  $<10\%$ . For meningiomas that are not surgically accessible, radiosurgery is the treatment of choice. Small asymptomatic meningiomas incidentally discovered in older patients can safely be followed radiologically; these tumors grow at an average rate of a few millimeters in diameter per year and only rarely become symptomatic.

Rare meningiomas invade the brain or have histologic evidence of malignancy such as nuclear pleomorphism and cellular atypia. A high mitotic index is also predictive of aggressive behavior. *Hemangiopericytoma*, although not strictly a meningioma, is a meningeal tumor with an especially aggressive behavior. Meningiomas with features of aggressiveness and hemangiopericytomas, even if totally excised by gross inspection, frequently recur and should receive postoperative radiotherapy. Chemotherapy has no proven benefit.

## SCHWANNOMAS

These tumors are also called *neuromas*, *neurinomas*, or *neurilemmomas*. They arise from Schwann cells of nerve roots, most frequently in the eighth cranial nerve (*vestibular schwannoma*, formerly termed *acoustic schwannoma* or

**FIGURE 43-6**

**Vestibular schwannoma.** **A.** Axial noncontrast MR scan through the cerebellopontine angle demonstrates an extraaxial mass that extends into a widened internal auditory canal, displacing the pons (arrows). **B.** Postcontrast T1-weighted image demonstrates intense enhancement of the vestibular schwannoma (white arrow). Abnormal enhancement of the left fifth nerve (black arrow) most likely represents another schwannoma in this patient with neurofibromatosis type 2.

*acoustic neuroma*). The fifth cranial nerve is the second most frequent site; however, schwannomas may arise from any cranial or spinal root except the optic and olfactory nerves, which are myelinated by oligodendroglia rather than Schwann cells. Neurofibromatosis (NF) type 2 (see later) strongly predisposes to vestibular schwannoma. Schwannomas of spinal nerve roots also occur in patients with NF type 2 as well as patients with NF type 1.

Eighth cranial nerve schwannomas typically arise from the vestibular division of the nerve. On MRI they are densely and uniformly enhancing neoplasms (Fig. 43-6). Vestibular schwannomas enlarge the internal auditory canal, an imaging feature that helps distinguish them from other cerebellopontine angle masses. Because the vestibular system adapts to slow destruction of the eighth nerve, patients with vestibular schwannomas characteristically present with progressive unilateral hearing loss rather than with dizziness or other vestibular symptoms. Unexplained unilateral hearing loss merits evaluation with audiometry and an MRI scan. As a vestibular schwannoma grows, it can compress the cerebellum, pons, or facial nerve. With rare exceptions schwannomas are histologically and clinically benign.

Whenever possible, schwannomas should be surgically excised. When the tumors are small, it is usually possible to preserve hearing in the involved ear. In the case of large tumors, the patient is usually deaf at presentation; nonetheless, surgery is indicated to prevent further compression of posterior fossa structures. Stereotaxic radiosurgery is also effective treatment for schwannoma and has a complication rate equivalent to that of surgery.

## OTHER BENIGN BRAIN TUMORS

*Epidermoid tumors* are cystic tumors with proliferative epidermal cells at the periphery and more mature epidermal cells towards the center of the cyst. The mature cells desquamate into the liquid center of the cyst. Epidermoid tumors are thought to arise from embryonic epidermal

rests within the cranium. They occur extraaxially near the midline, in the middle cranial fossa, the suprasellar region, or the cerebellopontine angle. These well-demarcated lesions are amenable to complete surgical excision. Postoperative radiation therapy is unnecessary.

*Dermoid cysts* are thought to arise from embryonic rests of skin tissue trapped within the CNS during closure of the neural tube. The most frequent locations are in the midline supratentorially or at the cerebellopontine angle. Histologically, they are composed of multiple elements of the dermis including epidermis, hair follicles, and sweat glands; they frequently calcify. Treatment is surgical excision.

*Craniopharyngiomas* are thought to arise from remnants of Rathke's pouch, the mesodermal structure from which the anterior pituitary gland is derived. Craniopharyngiomas typically present as suprasellar masses. Because of their location, they may present as growth failure in children, endocrine dysfunction in adults, or visual loss in either age group. Histologically, craniopharyngiomas resemble epidermoid tumors; they are usually cystic, and in adults 80% are calcified. Treatment is surgical excision; postoperative external beam radiation or stereotaxic radiosurgery is added if total surgical removal cannot be achieved.

*Colloid cysts* are benign tumors of unknown cellular origin that occur within the third ventricle and can obstruct CSF flow. Other *rare benign primary brain tumors* include neurocytomas, subependymomas, and pleomorphic xanthoastrocytomas. Surgical excision of these neoplasms is the primary treatment and can be curative.

## NEUROCUTANEOUS SYNDROMES

This group of genetic disorders, also known as the *phakomatoses*, produces a variety of developmental abnormalities of skin along with an increased risk of nervous system tumors (Table 43-1). These disorders are inherited as autosomal dominant conditions with variable penetrance.

## NEUROFIBROMATOSIS TYPE 1 (VON RECKLINGHAUSEN'S DISEASE)

NF1 is characterized by cutaneous *neurofibromas*, pigmented lesions of the skin called *café au lait spots*, freckling in non-sun-exposed areas such as the axilla, hamartomas of the iris termed *Lisch nodules*, and pseudoarthrosis of the tibia. Neurofibromas are benign peripheral nerve tumors composed of proliferating Schwann cells and fibroblasts. They present as multiple, palpable, rubbery, cutaneous tumors. They are generally asymptomatic; however, if they grow in an enclosed space, e.g., the intervertebral foramen, they may produce a compressive radiculopathy or neuropathy. Aqueductal stenosis with hydrocephalus, scoliosis, short stature, hypertension, epilepsy, and mental retardation may also occur.

Patients with NF1 are at increased risk of developing nervous system neoplasms, including plexiform neurofibromas, optic pathway gliomas, ependymomas, meningiomas, astrocytomas, and pheochromocytomas. Neurofibromas may undergo secondary malignant degeneration and become sarcomatous.

Mutation of the *NF1* gene on chromosome 17 causes von Recklinghausen's disease. The *NF1* gene is a tumor-suppressor gene; it encodes a protein, *neurofibromin*, which modulates signal transduction through the *ras* GTPase pathway.

## NEUROFIBROMATOSIS TYPE 2

NF2 is characterized by the development of bilateral vestibular schwannomas in >90% of individuals who inherit the gene. Patients with NF2 also have a predisposition for the development of meningiomas, gliomas, and schwannomas of cranial and spinal nerves. In addition, a characteristic type of cataract, juvenile posterior subcapsular lenticular opacity, occurs in NF2. Multiple café au lait spots and peripheral neurofibromas occur rarely.

In patients with NF2, vestibular schwannomas are usually associated with progressive unilateral deafness early in the third decade of life. Bilateral vestibular schwannomas are generally detectable by MRI at that time (Fig. 43-6). Surgical management is designed to treat the underlying tumor and preserve hearing as long as possible.

This syndrome is caused by mutation of the *NF2* gene on chromosome 22q. *NF2* encodes a protein called *neurofibromin 2*, *schwannomin*, or *merlin*, with homology to a family of cytoskeletal proteins that includes moesin, ezrin, and radixin.

## TUBEROUS SCLEROSIS (BOURNEVILLE'S DISEASE)

Tuberous sclerosis is characterized by cutaneous lesions, seizures, and mental retardation. The cutaneous lesions include adenoma sebaceum (facial angiofibromas), ash

leaf-shaped hypopigmented macules (best seen under ultraviolet illumination with a Wood's lamp), shagreen patches (yellowish thickenings of the skin over the lumbosacral region of the back), and depigmented nevi. Recognizable by neuroimaging studies, the presence of subependymal nodules, which may be calcified, is characteristic. Tuberous sclerosis patients are at increased risk of developing ependymomas and childhood astrocytomas, of which >90% are *subependymal giant cell astrocytomas*. These are benign neoplasms that may develop in the retina or along the border of the lateral ventricles. They may obstruct the foramen of Monro and produce hydrocephalus. Rhabdomyomas of the myocardium and angiomyomas of the kidney, liver, adrenals, and pancreas may also occur.

Treatment is symptomatic. Anticonvulsants for seizures, shunting for hydrocephalus, and behavioral and educational strategies for mental retardation are the mainstays of management. Severely affected individuals generally die before age 30.

Mutations in either the *TSC-1* gene at 9q or the *TSC-2* gene at 16p are associated with tuberous sclerosis. These genes encode *tuberins*, proteins that modulate the GTPase activity of other cellular signaling proteins.

## VON HIPPEL-LINDAU SYNDROME

This syndrome consists of retinal, cerebellar, and spinal hemangioblastomas, which are slowly growing cystic tumors. Hypernephroma, renal cell carcinoma, pheochromocytoma, and benign cysts of the kidneys, pancreas, epididymis, or liver may also occur. Erythropoietin produced by hemangioblastomas may result in polycythemia. Mutation of the von Hippel-Lindau (*VHL*) gene on chromosome 3p, a tumor-suppressor gene, causes this disorder. *VHL* encodes a protein with multiple functions, including modulation of signal transduction in response to cellular hypoxia.

## TUMORS METASTATIC TO BRAIN

### MECHANISMS OF BRAIN METASTASES

Brain metastases arise from hematogenous spread. The anatomic distribution of brain metastases generally parallels regional cerebral blood flow, with a predilection for the gray matter-white matter junction and for the border zone between middle cerebral and posterior cerebral artery distributions. The lung is the most common origin of brain metastases; both primary lung cancer and cancers metastatic to the lung frequently metastasize to the brain. Breast cancer (especially ductal carcinoma) has a propensity to metastasize to the cerebellum and the posterior pituitary gland. Other common origins of brain metastases are gastrointestinal malignancies and melanoma (Table 43-2). Certain less

TABLE 43-2

FREQUENCY OF NERVOUS SYSTEM METASTASES BY COMMON PRIMARY TUMORS			
SITE OF PRIMARY TUMOR	BRAIN METASTASES, %	LEPTOMENINGEAL METASTASES, %	SPINAL CORD COMPRESSION, %
Lung	40	24	18
Breast	19	41	24
Melanoma	10	12	4
Gastrointestinal tract	7	13	6
Genitourinary tract	7		18
Other	17	10	30

common tumors have a special propensity to metastasize to brain, including germ cell tumors and thyroid cancer. By contrast, prostate cancer, ovarian cancer, and Hodgkin's disease rarely metastasize to the brain.

### EVALUATION OF METASTASES FROM KNOWN CANCER

On MRI scans brain metastases typically appear as well-demarcated, approximately spherical lesions that are hypointense or isointense relative to brain on T1-weighted images and bright on T2-weighted images. They invariably enhance with gadolinium, reflecting extravasation of gadolinium through tumor vessels that lack a blood-tumor barrier (Fig. 43-7). Small metastases often enhance uniformly. Larger metastases typically produce ring enhancement surrounding a central mass of nonenhancing necrotic tissue that develops as the metastasis outgrows its blood supply. Metastases are surrounded by variable amounts of edema. Blood products may also be seen, reflecting hemorrhage of abnormal tumor vessels.

The radiologic appearance of a brain metastasis is not specific. The differential diagnosis of ring-enhancing

lesions includes brain abscess, radiation necrosis, toxoplasmosis, granulomas, tuberculosis, sarcoidosis, demyelinating lesions, primary brain tumors, primary CNS lymphoma, stroke, hemorrhage, and trauma. Contrast-enhanced CT scanning is less sensitive than MRI for the detection of brain metastases. Cytologic examination of the CSF is not indicated because intraparenchymal brain metastases almost never shed cells into the CSF.

### BRAIN METASTASES WITHOUT A KNOWN PRIMARY TUMOR

In general hospital populations, up to a third of patients presenting with brain metastases do not have a previously known underlying cancer. These patients generally present with either a seizure or a progressive neurologic deficit. Neuroimaging studies typically demonstrate one or multiple ring-enhancing lesions. In individuals who are not immunocompromised and not at risk for brain abscesses, this radiologic pattern is most likely due to brain metastasis.

Diagnostic evaluation begins with a search for the primary tumor. Blood tests should include carcinoembryonic antigen and liver function tests. Examination of

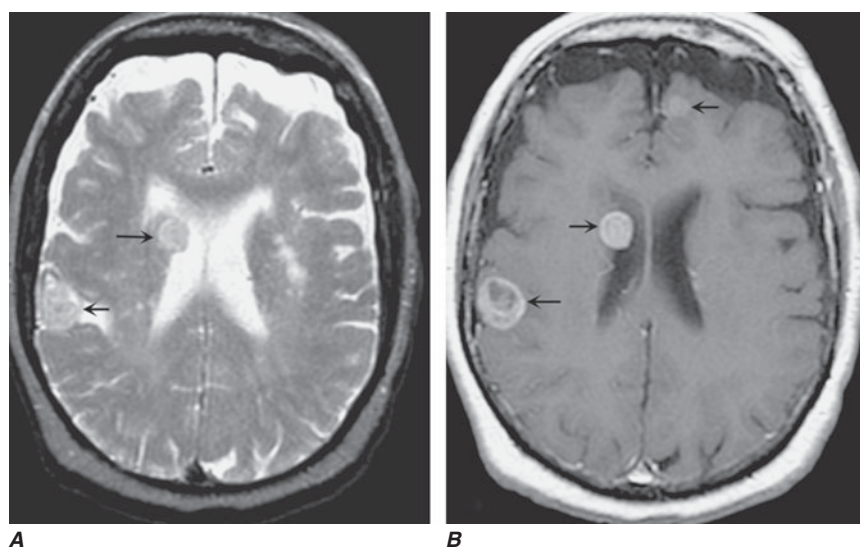


FIGURE 43-7

**Brain metastasis.** **A.** Axial T2-weighted MRI through the lateral ventricles reveals two isodense masses, one in the subependymal region and one near the cortex (arrows). **B.** T1-weighted postcontrast image at the same level as **A** reveals enhancement of the two masses seen on the T2-weighted image as well as a third mass in the left frontal lobe (arrows).

the skin for melanoma and the thyroid gland for masses should be carried out. The search for a primary cancer most often discloses lung cancer (particularly small cell lung cancer) or melanoma. In 30% of patients no primary tumor can be identified, even after extensive evaluation. A CT scan of the chest, abdomen, and pelvis should be obtained. If these are all negative, further imaging studies, including bone scan, other radionuclide scans, mammography, and upper and lower gastrointestinal barium studies, are unlikely to be productive.

A tissue diagnosis is essential. If a primary tumor is found, it will usually be more accessible to biopsy than a brain lesion. If a single brain lesion is found in a surgically accessible location, if a primary tumor is not found, or if the primary tumor is in a location difficult to biopsy, the brain metastasis should be biopsied or resected.

### **Rx Treatment:** **TUMORS METASTATIC TO BRAIN**

Once a systemic cancer metastasizes to the brain it is, with rare exception, incurable. Therapy is therefore palliative, designed to prevent disability and suffering and, if possible, to prolong life. Published outcome studies have focused on survival as the primary endpoint, leaving questions regarding quality of life unanswered. There is, however, widespread agreement that glucocorticoids, anticonvulsants, radiation therapy, and surgery (see later) can contribute to the management of these patients.

**GENERAL MEASURES** Glucocorticoids frequently ameliorate symptoms of brain metastases. Improvement is often dramatic, occurring within 24 h, and is sustained with continued administration, although the toxicity of glucocorticoids is cumulative. Therefore, if possible, a more definitive therapy for metastases should be instituted to permit withdrawal of glucocorticoid therapy. A third of patients with brain metastases have one or more seizures; anticonvulsants are used empirically for seizure prophylaxis.

#### **SPECIFIC MEASURES**

**Radiation Therapy** Radiation therapy is the primary treatment for brain metastases. Because multiple microscopic deposits of tumor cells throughout the brain are likely to be present in addition to metastases visualized by neuroimaging studies, WBRT is usually used. Its benefit has been established in controlled studies, but no clear dose response has been shown. Usually, 30–37.5 Gy is administered in 10–15 fractions; an additional dose (“boost”) of focal irradiation to a single or large metastasis may also be administered. Stereotaxic radiosurgery is of benefit in patients with four or fewer metastases demonstrable by MRI. The addition of WBRT to stereotaxic radiosurgery delays tumor recurrence in the brain but does not prolong survival.

**Surgery** Up to 40% of patients with brain metastases have only a single tumor mass identified by CT. Accessible single metastases may be surgically excised as a palliative measure. If the systemic disease is under control, total resection of a single brain lesion has been demonstrated to improve survival and minimize disability. Survival is further improved if surgery is followed by WBRT.

**Chemotherapy** Brain metastases of certain tumors, including breast cancer, small cell lung cancer, and germ cell tumors, are often responsive to systemic chemotherapy. Although metastases frequently do not respond as well as the primary tumor, dramatic responses to systemic chemotherapy or hormonal therapy may occur in some cases. In patients who are neurologically asymptomatic, two to four cycles of systemic chemotherapy may be administered initially to reduce tumor mass and render the residual tumor more amenable to radiation therapy. Even if a complete radiologic remission is achieved from chemotherapy, WBRT should then be administered. Gene therapy, immunotherapy, intraarterial chemotherapy, and chemotherapy administered following osmotic disruption of the blood-brain barrier are currently under investigation.

## **LEPTOMENINGEAL METASTASES**

Leptomeningeal metastases are also called *carcinomatous meningitis*, *meningeal carcinomatosis*, and, in the case of specific tumors, *leukemic meningitis* or *lymphomatous meningitis*. Clinical evidence of leptomeningeal metastases is present in 8% of patients with metastatic solid tumors; at necropsy, the prevalence is as high as 19%. Among solid tumors, adenocarcinomas of the breast, lung, and gastrointestinal tract and melanoma are the most common cause of leptomeningeal metastases (Table 43-2). In a quarter of patients the systemic cancer is under control, and especially in these patients the effective control of leptomeningeal disease can improve the quality and duration of life.

Cancer usually metastasizes to the meninges via the bloodstream. Alternatively, cells may invade the subarachnoid space directly from a superficially located parenchymal brain metastasis. Some tumors, including squamous cell carcinoma of the skin and some non-Hodgkin's lymphomas, have a propensity to grow along peripheral nerves and may seed the meninges by that route.

## **CLINICAL FEATURES**

Leptomeningeal metastases present with signs and symptoms at multiple levels of the nervous system, most often in a setting of known systemic malignancy. Encephalopathy is frequent, and cranial neuropathy or spinal radiculopathy from nodular nerve root compression is characteristic.

**FIGURE 43-8**

**Carcinomatous meningitis.** Sagittal postcontrast MRI through the lower thoracic region demonstrates diffuse pial enhancement along the surface of the spinal cord (arrows), typical of CSF spread of neoplasm.

Hydrocephalus can result from obstruction of CSF outflow. Focal neurologic deficits reflect coexisting intraparenchymal metastases.

### LABORATORY AND IMAGING EVALUATION

Leptomeningeal metastases are diagnosed by cytologic demonstration of malignant cells in the CSF, by MRI demonstration of nodular tumor deposits or diffuse enhancement in the meninges (Fig. 43-8), and by meningeal biopsy. CSF findings are usually those of an inflammatory meningitis consisting of lymphocytic pleocytosis, elevated protein levels, and normal or low CSF glucose. A positive CSF cytology is unequivocal evidence of tumor spread to the subarachnoid space. CSF examination is more likely to be informative when larger volumes of CSF are submitted for cytology and when up to three CSF examinations are performed. A complete MRI examination of the neuraxis is indicated in all cases of suspected leptomeningeal metastases; in addition to nodular meningeal lesions, hydrocephalus due to obstruction of CSF pathways may be found.

#### **Rx Treatment:** **LEPTOMENINGEAL METASTASES**

Although the prognosis of patients with leptomeningeal metastases is poor, ~20% of patients treated aggressively can expect a response of  $\geq 6$  months. Intrathecal therapy

exposes meningeal tumor implants to high concentrations of chemotherapy with minimal systemic toxicity. Methotrexate can be safely administered intrathecally and is effective against leptomeningeal metastases from a variety of solid tumors including lymphoma; cytarabine and thiotepea are alternative agents. Liposomal cytarabine provides prolonged cytotoxic levels of cytarabine in the CSF, requiring administration only every 2 weeks, in contrast to weekly or twice weekly administration of other agents. Intrathecal chemotherapy may be administered either by repeated lumbar puncture or through an indwelling Ommaya reservoir, which consists of a catheter in one lateral ventricle attached to a reservoir implanted under the scalp. If there is a question of patency of CSF pathways, a radionuclide flow study through the reservoir may be performed.

Large nodular deposits of tumor on the meninges or along nerve roots are unlikely to respond to intrathecal chemotherapy because the barrier to diffusion is too great. Therefore, external beam radiation is employed, and these patients may also benefit from systemic chemotherapy. Hydrocephalus is treated with a ventriculoperitoneal shunt, although seeding of the peritoneum by tumor is a risk.

### MALIGNANT SPINAL CORD COMPRESSION

Spinal cord compression from solid tumor metastases usually results from growth of a vertebral metastasis into the epidural space. Primary tumors that frequently metastasize to bone include lung, breast, and prostate cancer. Back pain is usually the first symptom and is prominent at presentation in 90% of patients. The pain is typically dull, aching, and may be associated with localized tenderness. If a nerve root is compressed, radicular pain is also present. The thoracic cord is most often affected. Weakness, sensory loss, and autonomic dysfunction (urinary urgency and incontinence, fecal incontinence, and sexual impotence in men) are hallmarks of spinal cord compression. Once signs of spinal cord compression appear, they tend to progress rapidly. It is thus essential to recognize and treat this serious complication of malignancy promptly to prevent irreversible neurologic deficits.

### METASTASES TO THE PERIPHERAL NERVOUS SYSTEM

Systemic cancer may compress or invade peripheral nerves. Compression of the brachial plexus may occur by direct extension of Pancoast's tumors (cancer of the apex of the lung), by lymphoma, or by extension of



local lymph node metastases in breast or lung cancer. The lumbosacral plexus may be compressed by retroperitoneal tumor invasion such as occurs in cases of prostate or ovarian cancer or lymphoma. Skull metastases may compress cranial nerve branches as they pass through the skull, and pituitary metastases may extend into the cavernous sinus.

The epineurium generally provides an effective barrier to invasion of the peripheral nerves by solid tumors, but certain tumors characteristically invade and spread along peripheral nerves. Squamous cell carcinoma of the skin may spread along the trigeminal nerve and extend intracranially. Non-Hodgkin's lymphoma may be neurotrophic and cause polyradiculopathy or a syndrome resembling mononeuropathy multiplex. Focal external beam radiation may reduce pain, prevent irreversible loss of peripheral nerve function, and possibly restore function.

In patients with cancer who have brachial or lumbosacral plexopathy, it may be difficult to distinguish tumor invasion from radiation injury. High radiation dose or the presence of myokymia (rippling contractions of muscle) suggests radiation injury, whereas pain suggests tumor. Radiographic imaging studies may be equivocal, and surgical exploration is sometimes required.

## COMPLICATIONS OF THERAPY

### RADIATION TOXICITY

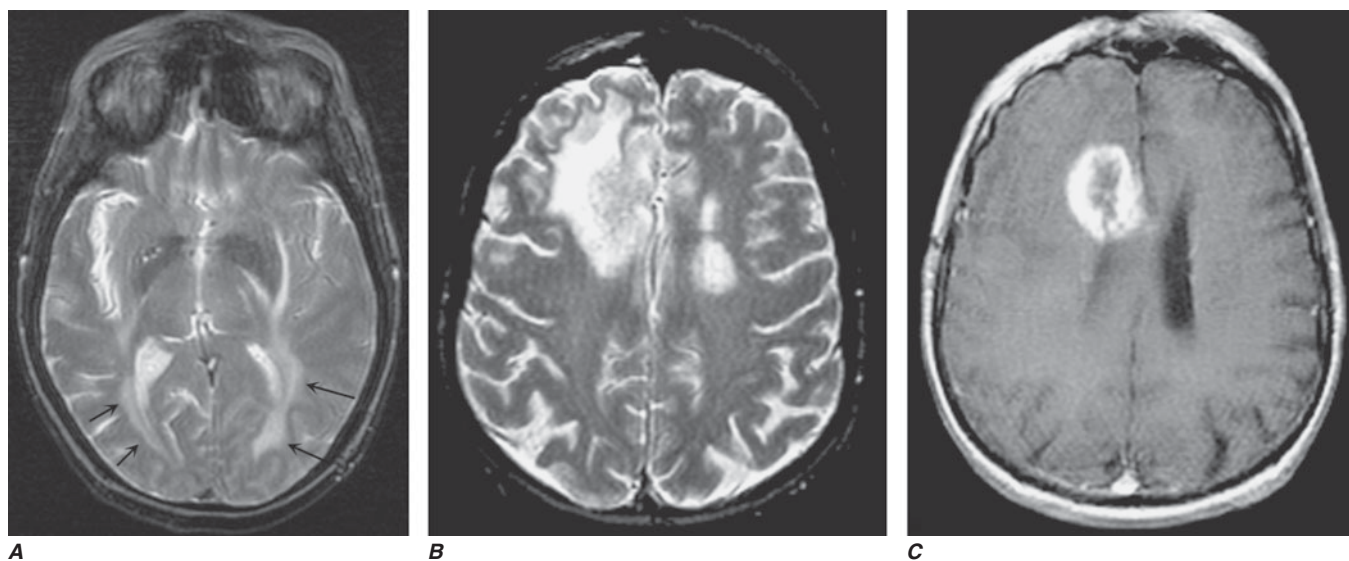
The nervous system is vulnerable to injury by therapeutic radiation. Histologically, there is demyelination,

degeneration of small arterioles, and eventually brain infarction and necrosis.

*Acute radiation injury* to the brain occurs during or immediately after therapy. It is rarely seen with current protocols of external beam radiation but may occur after stereotaxic radiosurgery. Manifestations include headache, sleepiness, and worsening of preexisting neurologic deficits.

*Early delayed radiation injury* occurs within 4 months of therapy. It is associated with an increased white matter T2 signal on MRI scans. In children, the *somnolence syndrome* is a common form of early delayed radiation injury in which somnolence and ataxia develop after WBRT. Irradiation of the cervical spine may cause Lhermitte's phenomenon, an electricity-like sensation evoked by neck flexion. Symptoms resulting from acute and early delayed radiation injury often respond to glucocorticoid administration, are self-limited, and usually resolve without residual deficits. These injuries do not increase the risk of late radiation injury.

*Late delayed radiation injury* produces permanent damage to the nervous system. It occurs >4 months (generally 8–24 months) after completion of therapy; onset as late as 15 years after therapy has been described. Following focal brain irradiation, radiation necrosis can occur within the radiation field, producing a contrast-enhancing (frequently ring-enhancing) mass with surrounding white matter signal abnormalities (Fig. 43-9). MRI or CT scans are often unable to distinguish radiation necrosis from recurrent tumor, but PET or SPECT scans may demonstrate the increased glucose metabolism typical of tumor tissue or the decreased metabolism of necrotic



**FIGURE 43-9**

**Radiation injury.** **A.** Late delayed radiation injury 1 year after whole-brain radiation (5500 cGy). T2-weighted MR image at the level of the temporal lobes reveals high signal intensity abnormality in periventricular white matter (arrows). **B** and **C.** Focal radiation necrosis 3 years after radiotherapy (7000 cGy)

for carcinoma of the nasopharynx. Axial T2-weighted MRI (**B**) demonstrates a mass in the right frontal lobe with surrounding vasogenic edema. Abnormal signal changes are also present on the left. T1-weighted postcontrast MRI (**C**) reveals a heterogeneously enhancing mass in the right cingulate gyrus.

tissue. Magnetic resonance spectroscopy may demonstrate a high lactate concentration with relatively low choline concentration in areas of necrosis. Biopsy is frequently required to establish the correct diagnosis. Peripheral nerves, including the brachial and lumbosacral plexuses, may also develop late delayed radiation injury.

If untreated, radiation necrosis of the CNS may act as an expanding mass lesion. Symptoms may resolve spontaneously or respond to treatment with glucocorticoids. Progressive radiation necrosis is best treated with surgical resection if the patient has a life expectancy of at least 6 months and a Karnofsky performance score >70. There are anecdotal reports that anticoagulation with heparin or warfarin may be beneficial. After WBRT, progressive dementia can occur, often accompanied by gait apraxia and urinary incontinence. Radiation injury of large arteries also accelerates the development of atherosclerosis, but an increase in the risk of stroke becomes significant only years after radiation treatment.

Endocrine dysfunction resulting in hypopituitarism frequently follows exposure of the hypothalamus or pituitary gland to therapeutic radiation. Growth hormone is the pituitary hormone most sensitive to radiation therapy, and thyroid-stimulating hormone is the least sensitive; ACTH, prolactin, and the gonadotropins have an intermediate sensitivity.

Development of a second neoplasm is another risk of therapeutic radiation that generally occurs many years after radiation exposure. Depending on the irradiated field, the risk of gliomas, meningiomas, sarcomas, and thyroid cancer is increased.

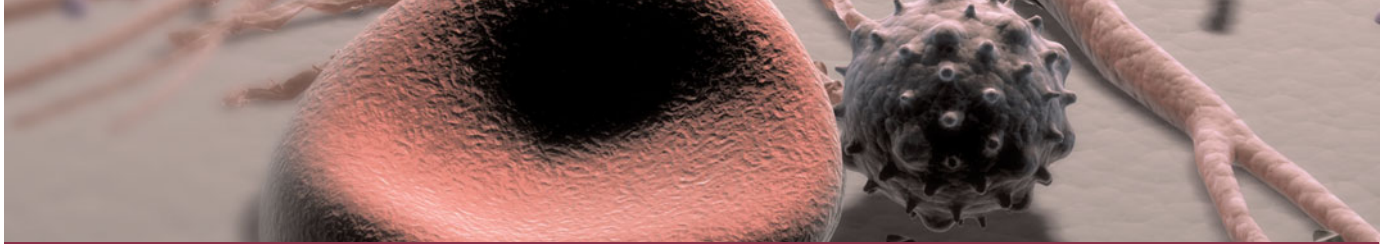
## TOXICITIES OF CHEMOTHERAPY

Chemotherapy regimens used to treat primary brain tumors generally include alkylating agents, either temozolomide or nitrosoureas, and are relatively well tolerated.

Infrequently, drugs used to treat CNS neoplasms are associated with the development of altered mental states (e.g., confusion, depression), ataxia, and seizures. Chemotherapy for systemic malignancy is a more frequent cause of nervous system toxicity and is more often toxic to the peripheral than the central nervous system. Cisplatin commonly produces tinnitus and high-frequency bilateral hearing loss, especially in younger patients. At cumulative doses >450 mg/m<sup>2</sup>, cisplatin can produce a symmetric, large-fiber axonal neuropathy that is predominantly sensory; paclitaxel (Taxol) produces a similar picture. Fluorouracil and high-dose cytarabine can cause cerebellar dysfunction that resolves after discontinuation of therapy. Vincristine, which is commonly used to treat lymphoma, may cause an acute ileus and is frequently associated with development of a progressive distal, symmetric sensory motor neuropathy with foot drop and paresthesias.

## FURTHER READINGS

- ARGYRIOU AA, KALOFONOS HP: Molecularly targeted therapies for malignant gliomas. *Mol Med* 15:115, 2009
- BATCHELOR T, LOEFFLER JS: Primary CNS lymphoma. *J Clin Oncol* 24:1281, 2006
- DEANGELIS L: Chemotherapy for brain tumors—a new beginning. *N Engl J Med* 352:1036, 2005
- FRIEDMAN HS, BIGNER DD: Glioblastoma multiforme and the epidermal growth factor receptor. *N Engl J Med* 353:1997, 2005
- KEIME-GUIBERT F et al: Radiotherapy for glioblastoma in the elderly. *N Engl J Med* 356:1527, 2007
- LINO M, MERLO A: Translating biology into clinic: The case of glioblastoma. *Curr Opin Cell Biol* 21:311, 2009
- MCKUSICK VA (ed): *Online Mendelian Inheritance in Man*. URL: [www.ncbi.nlm.nih.gov/Omim/](http://www.ncbi.nlm.nih.gov/Omim/). Washington, DC, National Library of Medicine, 2007
- MORRIS PG, ABREY LE: Therapeutic challenges in primary CNS lymphoma. *Lancet Neurol* 8:581, 2009
- RANJAN T, ABREY LE: Current management of metastatic brain disease. *Neurotherapeutics* 6:598, 2009



## CHAPTER 44

# CARCINOMA OF UNKNOWN PRIMARY

Gauri R. Varadhachary ■ James L. Abbruzzese

■ CUP Biology .....	562
Clinical Evaluation .....	562
Pathologic Diagnosis of CUP .....	563
Role of DNA Microarray and Reverse Transcriptase Polymerase Chain Reaction (RT-PCR) in CUP .....	565
■ Summary .....	567
■ Further Readings .....	567

Carcinoma of unknown primary (CUP) is a biopsy-proven (mainly epithelial) malignancy for which the anatomic site of origin remains unidentified after an intensive search. CUP is one of the 10 most frequently diagnosed cancers worldwide, accounting for ~3–5% of all cancer cases. Most investigators do not consider lymphomas, metastatic melanomas, and metastatic sarcomas that present without a known primary tumor to be CUP because these cancers have specific stage- and histology-based treatments that can guide management.

A standard workup for CUP includes a medical history; physical examination; and laboratory studies, including liver and renal function tests, hemogram, chest x-ray, CT scan of the abdomen and pelvis, mammography in women, and prostate-specific antigen (PSA) test in men. With the increasing availability of additional sophisticated imaging techniques and the emergence of targeted therapies that have been shown to be effective in several cancers, oncologists must decide on the extent of workup that is warranted. Specifically, they must consider how additional diagnostic procedures may affect the choice of therapy and the patient's survival and quality of life.

The reason tumors present as CUP remains unclear. One hypothesis is that the primary tumor either regresses after seeding the metastasis or remains so small that it is not detected. It is possible that CUP falls on the continuum of cancer presentation where the primary has been contained or eliminated by the natural body

defenses. Alternatively, CUP may represent a specific malignant event that results in an increase in metastatic spread or survival relative to the primary. Whether the CUP metastases truly define a clone that is genetically and phenotypically unique to this diagnosis remains to be determined.

### CUP BIOLOGY

No characteristics that are unique to CUP relative to metastases from known primaries have been identified. Abnormalities in chromosomes 1 and 12 and other complex abnormalities have been found. Aneuploidy has been described in 70% of CUP patients with metastatic adenocarcinoma or undifferentiated carcinoma. The overexpression of various genes, including *Ras*, *bcl-2* (40%), *her-2* (11%), and *p53* (26–53%), has been studied in CUP samples, but they seem to have no effect on response to therapy or survival. The extent of angiogenesis in CUP relative to that in metastases from known primaries has also been evaluated, but no consistent findings have emerged.

### CLINICAL EVALUATION

Obtaining a thorough medical history from CUP patients is essential, paying particular attention to previous surgeries, removed lesions, and family medical history to assess potential hereditary cancers. Physical

examination, including a digital rectal examination in men and breast and pelvic examinations in women, should be performed. Determining the patient's performance status, nutritional status, comorbid illnesses, and cancer-induced complications is essential because they may affect treatment planning.

### **Role of Serum Tumor Markers and Cytogenetics**

Most tumor markers, including CEA, CA-125, CA 19-9, and CA 15-3, when elevated, are nonspecific and not helpful in determining the primary tumor site. Men who present with adenocarcinoma and osteoblastic metastasis should undergo a PSA test. Patients with an elevated PSA should be treated as having prostate cancer. In patients with undifferentiated or poorly differentiated carcinoma (especially with a midline tumor), elevated  $\beta$ -human chorionic gonadotropin ( $\beta$ hCG) and  $\alpha$  fetoprotein (AFP) levels suggest the possibility of an extragonadal germ cell (testicular) tumor. Cytogenetic studies had a larger role in the past, although interpretation of these older studies can be challenging. In our opinion, with the availability of immunohistochemical stains, cytogenetic analyses are indicated only occasionally. We reserve them for undifferentiated neoplasms with inconclusive immunohistochemical stains and those for which a high suspicion of lymphoma exists.

### **Role of Imaging Studies**

Chest x-rays are always obtained in CUP workups but are often negative, especially with low-volume disease. CT scans of the chest, abdomen, and pelvis can be used to help find the primary, evaluate the extent of disease, and select the most favorable biopsy site. Older studies suggested that the primary tumor site is detected in 20–35% of patients who undergo a CT scan of the abdomen and pelvis, although by current definition these patients would not be considered as having CUP. Older studies also suggest a latent primary tumor prevalence of 20%; with more sophisticated imaging, this prevalence is <10% today.

Mammography should be performed in all women who present with metastatic adenocarcinoma, especially in those with adenocarcinoma and isolated axillary adenopathy. MRI of the breast is a recognized follow-up modality in patients with suspected occult primary breast carcinoma (following negative mammography and sonography findings). The results of these imaging modalities can influence surgical management; a negative breast MRI result predicts a low tumor yield at mastectomy.

A conventional workup for a cervical CUP (neck lymphadenopathy with no known primary tumor) includes a CT scan or MRI and invasive studies, including

indirect and direct laryngoscopy, bronchoscopy, and upper endoscopy. Ipsilateral (or bilateral) tonsillectomy (with histopathology) has been recommended for cervical CUP patients. [ $^{18}$ F]-fluorodeoxyglucose (FDG) positron emission tomography (PET) scans are useful in this patient population and may help guide the biopsy; determine the extent of disease; facilitate the appropriate treatment, including planning radiation fields; and help with disease surveillance. Several studies have evaluated the utility of PET in patients with cervical CUP. These trials have included a small number of patients; primary tumors were identified in ~21–30%.

The diagnostic contribution of PET to the evaluation of noncervical CUP is controversial. PET or PET-CT helps to detect primary tumor in 20–35% of patients. PET-CT can be helpful for patients who are candidates for surgical intervention for solitary metastatic disease because the presence of disease outside the primary site will affect surgical consolidation planning.

Invasive studies, including upper endoscopy, colonoscopy, and bronchoscopy, should be limited to symptomatic patients or those with laboratory or pathologic abnormalities suggesting that these techniques will result in a high tumor yield.

### **PATHOLOGIC DIAGNOSIS OF CUP**

A detailed pathologic examination of the most accessible biopsied tissue specimen is mandatory in CUP cases. Pathologic evaluation typically consists of hematoxylin-and-eosin stains and immunohistochemical tests. Electron microscopy is rarely used currently, although it may be selectively useful when making treatment decisions.

#### **Light Microscopy Evaluation**

Adequate tissue obtained by fine-needle aspiration or core-needle biopsy should first be stained with hematoxylin and eosin and subjected to light microscopic examination. On light microscopy, 60% of CUPs are found to be adenocarcinoma, and 5% are squamous cell carcinoma. The remaining 30% of lesions are diagnosed as poorly differentiated adenocarcinoma, poorly differentiated carcinoma, or poorly differentiated neoplasm. A small percentage of lesions are diagnosed as neuroendocrine cancers (2%), mixed tumors (adenosquamous, or sarcomatoid carcinomas), or undifferentiated neoplasm ([Table 44-1](#)).

#### **Role of Immunohistochemical Analysis**

Immunohistochemical stains are peroxidase-labeled antibodies against specific tumor antigens that are used to define tumor lineage. The number of available immunohistochemical stains is ever-increasing. However, in CUP cases, more is not necessarily better, and

TABLE 44-1

## MAJOR HISTOLOGIES IN CUP

HISTOLOGY	PROPORTION, %
Well to moderately differentiated adenocarcinoma	60
Squamous cell cancer	5
Poorly differentiated adenocarcinoma, poorly differentiated carcinoma	30
Neuroendocrine	2
Undifferentiated malignancy	3

immunohistochemical stains should be used in conjunction with the patient's clinical presentation and imaging studies to select the best therapy. Communication between the clinician and pathologist is essential. No stain is 100% specific, and overinterpretation should be avoided. PSA and thyroglobulin tissue markers, which are positive in prostate and thyroid cancer, respectively, are the most specific of the current marker panel. However, these cancers rarely present as CUP, so the yield of these tests may be low. **Fig. 44-1** delineates a simple algorithm for immunohistochemical staining in CUP cases. **Table 44-2** lists additional tests that may be useful to further define the tumor lineage. A more comprehensive algorithm may improve the diagnostic accuracy but can make the process complex. With the use of immunohistochemical markers, electron microscopic analysis, which is time consuming and expensive, is rarely needed.

There are 20 subtypes of cytokeratin (CK) intermediate filaments with different molecular weights and differential expression in various cell types and cancers. Monoclonal antibodies to specific CK subtypes have been used to help classify tumors according to their site of origin; commonly used CK stains in CUP are CK7 and CK20. CK7 is found in tumors of the lung, ovary, endometrium, and breast and not in those of the lower gastrointestinal tract, whereas CK20 is normally expressed in the gastrointestinal epithelium, urothelium, and Merkel's cells. CK20+/CK7- strongly suggest a primary tumor of the

TABLE 44-2

## ADDITIONAL IMMUNOHISTOCHEMICAL STAINS USEFUL IN THE DIAGNOSIS OF CUP

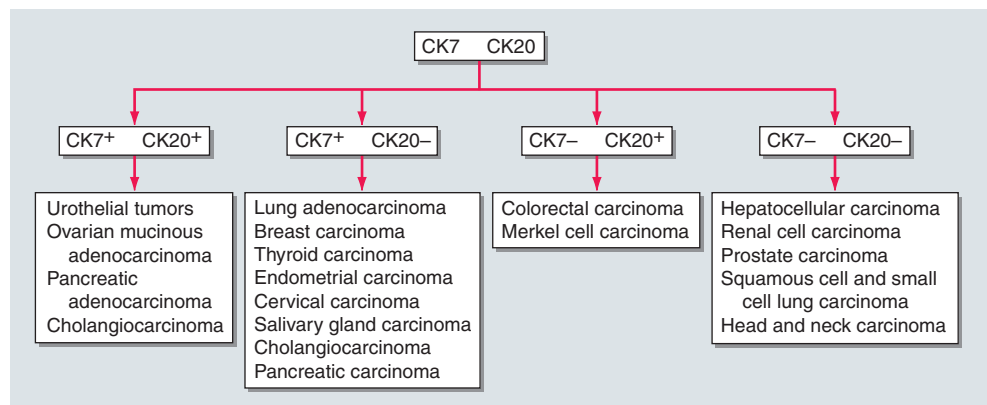
TISSUE MARKER	DIAGNOSIS
Estrogen and progesterone receptors	Breast cancer
BRST-1	Breast cancer
Gross cystic disease fibrous protein-15	Breast cancer
Thyroid transcription factor 1	Lung and thyroid cancer
Thyroglobulin	Thyroid cancer
Chromogranin, synaptophysin, neuron specific enolase	Neuroendocrine cancer
CDX-2	Gastrointestinal cancer
Calretinin, mesothelin	Mesothelioma
Leukocyte common antigen	Lymphoma
S-100, HMB-45	Melanoma
URO-III, thrombomodulin	Bladder cancer
$\alpha$ Fetoprotein	Hepatocellular cancer, germ cell cancer
$\beta$ -Human chronic gonadotropin	Germ cell cancer
Prostate-specific antigen	Prostate cancer

colon; 75–95% of colon tumors show this pattern of staining. CK20-/CK7+ suggests cancer of the lung, breast, ovary, endometrium, and pancreaticobiliary tract; some of these can also be CK20+. The nuclear CDX-2 transcription factor, which is the product of a homeobox gene necessary for intestinal organogenesis, is often used to aid in the diagnosis of gastrointestinal adenocarcinomas.

Thyroid transcription factor 1 (TTF-1) is a 38-kDa homeodomain-containing nuclear protein that plays a role in transcriptional activation during embryogenesis in the thyroid, diencephalon, and respiratory epithelium. TTF-1 nuclear staining is typically positive in lung and thyroid cancers. Approximately 68% of adenocarcinomas and 25% of squamous cell lung cancers stain positive for TTF-1, which helps differentiate a lung primary tumor from metastatic adenocarcinoma in a pleural effusion, the mediastinum, or the lung parenchyma.

FIGURE 44-1

Approach to cytokeratin (CK7 and CK20) markers used in CUP.



Distinguishing pleural mesothelioma from lung adenocarcinoma can be challenging. Calretinin, Wilms' tumor gene-1 (WT-1), and mesothelin have been suggested as useful markers for mesothelioma.

Gross cystic disease fibrous protein-15, a 15-kDa monomer protein, is a marker of apocrine differentiation that is detected in 62–72% of breast carcinomas. UROIII, high-molecular-weight cytokeratin, thombomodulin, and CK20 are the markers used to diagnose lesions of urothelial origin.

## ROLE OF DNA MICROARRAY AND REVERSE TRANSCRIPTASE POLYMERASE CHAIN REACTION (RT-PCR) IN CUP

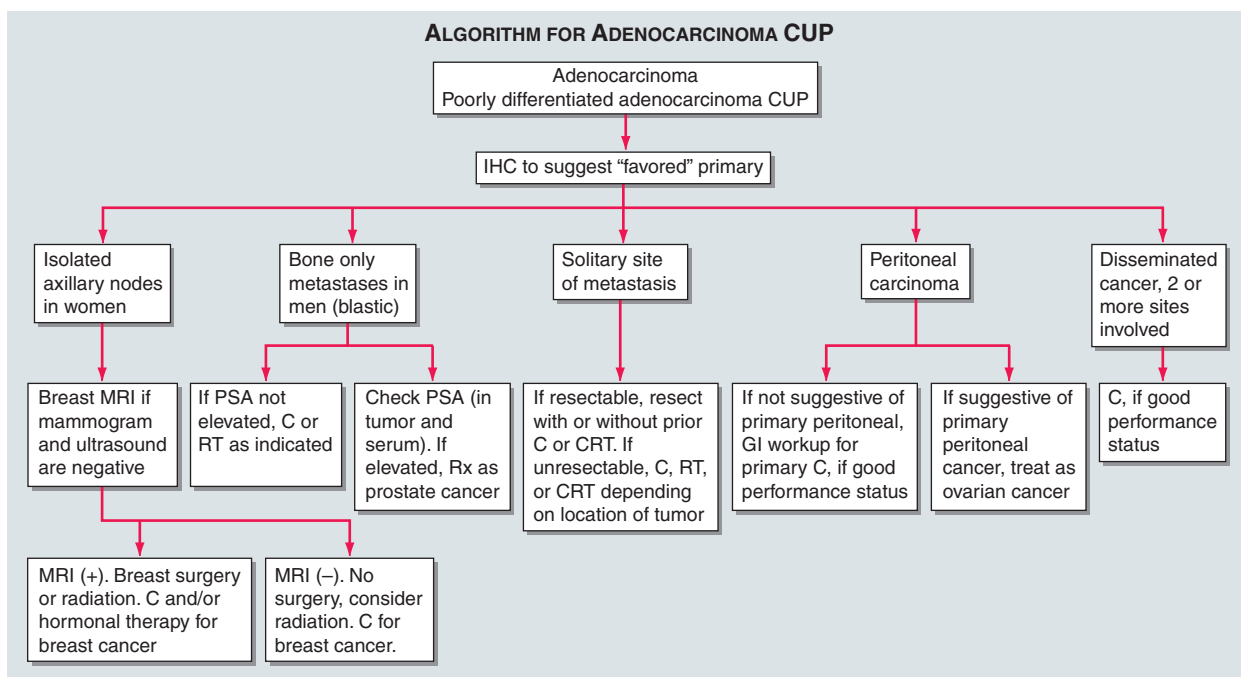
In the absence of a known primary, developing therapeutic strategies for CUP is challenging. The current diagnostic yield with imaging and immunochemistry is ~20–30% for CUP patients. The use of gene expression studies holds the promise of substantially increasing this yield. Gene expression profiles are most commonly generated using quantitative RT-PCR or DNA microarray.

Neural network programs have been used to develop predictive algorithms from the gene expression profiles. Typically, a training set of gene profiles from known cancers (preferably from metastatic sites) are used to train the software. The program can then be used to predict the origin of a test tumor, and presumably of true CUP. Comprehensive gene expression databases that have become available for common malignancies may

also be useful in CUP. Investigators have used expression data from normal differentiated tissues to identify conserved expression profiles found in malignant tissue as a basis for predicting the tissue of origin. These approaches have been effective in blind testing against known primary cancers and their metastasis. However, because, by definition, the primary tumor site is not identifiable in CUP, validation of site prediction in this setting can be challenging, and any predictions currently must be supported by clinical and pathologic correlation. Prospective validation trials are currently evaluating the role of molecular studies in CUP.

## Rx Treatment: CARCINOMA OF UNKNOWN PRIMARY

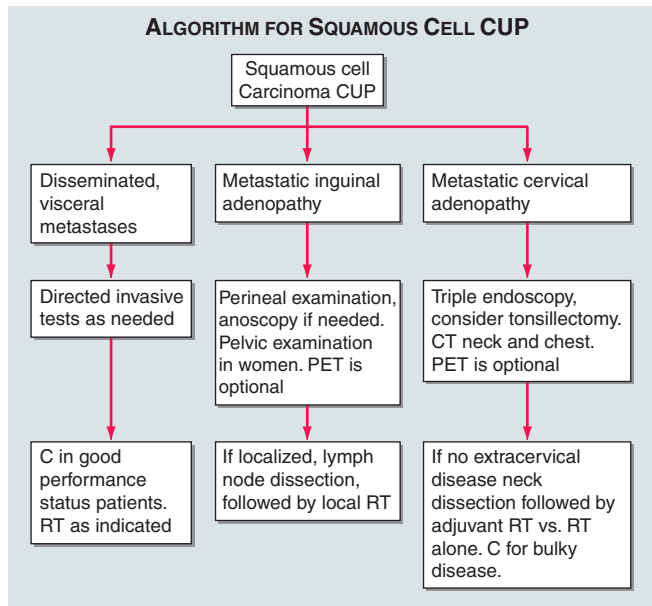
**GENERAL CONSIDERATIONS** The treatment of CUP continues to evolve, albeit slowly. The median survival duration of most patients with disseminated CUP is ~6–10 months. Systemic chemotherapy is the primary treatment modality in most cases, but the careful integration of surgery, radiation therapy, and even periods of observation are important in the overall management of this condition (Figs. 44-2 and 44-3). Prognostic factors include performance status, site and number of metastases, response to chemotherapy, and serum lactate dehydrogenase (LDH) levels. Culine and colleagues developed a prognostic model using performance status and serum LDH levels, which allowed the assignment of



**FIGURE 44-2**

**Treatment algorithm for adenocarcinoma and poorly differentiated adenocarcinoma CUP.** C, chemotherapy; IHC, immunohistochemistry; GI, gastrointestinal; CRT,

chemoradiation; RT, radiation; PSA, prostate-specific antigen; MRI, magnetic resonance imaging.

**FIGURE 44-3**

**Treatment algorithm for squamous cell CUP.** CT, computed tomography; PET, positron emission tomography; RT, radiation; C, chemotherapy.

patients into two subgroups with divergent outcomes. Future prospective trials using this prognostic model are warranted. Clinically, several CUP diagnoses fall into a favorable prognostic subset. Others, including those with disseminated CUP, have a more unfavorable prognosis.

#### **TREATMENT OF FAVORABLE SUBSETS OF CUP** **Women with Isolated Axillary Adenopathy**

Women with isolated axillary adenopathy with adenocarcinoma or carcinoma should be treated for stage II or III breast cancer. These patients should undergo a breast MRI if mammogram and ultrasound are negative. Radiation therapy to the ipsilateral breast is indicated if the breast MRI is positive. Chemotherapy and/or hormonal therapy is indicated based on patient's age (premenopausal or postmenopausal), nodal disease bulk, and hormone receptor status (Chap. 34).

#### **Women with Peritoneal Carcinomatosis**

The term *primary peritoneal papillary serous carcinoma* (PPSC) has been used to describe CUP with carcinomatosis with the pathologic and laboratory (elevated CA-125 antigen) characteristics of ovarian cancer but no ovarian primary tumor identified on transvaginal sonography or laparotomy. Studies suggest that ovarian cancer and PPSC, which are both of müllerian origin, have similar gene expression profiles. Similar to patients with ovarian cancer, patients with PPSC are candidates for cytoreductive surgery, followed by adjuvant taxane and platinum-based chemotherapy. In one retrospective study of 258 women with peritoneal carcinomatosis who had undergone cytoreductive surgery and

chemotherapy, 22% of patients had a complete response to chemotherapy; the median survival duration was 18 months (range: 11–24 months).

**Poorly Differentiated Carcinoma with Midline Adenopathy** Men with poorly differentiated or undifferentiated carcinoma that presents as a midline adenopathy should be evaluated for extragonadal germ cell malignancy. They often experience a good response to treatment with platinum-based combination chemotherapy. Response rates of >50% have been noted, and 10–15% long-term survivors have been reported.

**Neuroendocrine Carcinoma** Low-grade neuroendocrine carcinoma often has an indolent course, and treatment decisions are based on symptoms and tumor bulk. Urine 5-HIAA and serum chromogranin may be elevated and can be followed as markers. Often the patient is treated with somatostatin analogues alone for hormone-related symptoms (diarrhea, flushing, nausea). Specific local therapies or systemic therapy would only be indicated if the patient is symptomatic with local pain secondary to significant growth of the metastasis or the hormone-related symptoms are not controlled with endocrine therapy. Patients with high-grade neuroendocrine carcinoma are treated as having small cell lung cancer and are responsive to chemotherapy; 20–25% show a complete response, and up to 10% patients survive >5 years.

**Squamous Cell Carcinoma Presenting as Cervical Adenopathy** Patients with early-stage squamous cell carcinoma involving the cervical lymph nodes are candidates for node dissection and radiation therapy, which can result in long-term survival. The role of chemotherapy in these patients is undefined, although chemoradiation therapy or induction chemotherapy is often used and is beneficial in bulky N2/N3 lymph node disease.

**Solitary Metastatic Site** Patients with solitary metastases can also experience good treatment outcomes. Some patients who present with locoregional disease are candidates for aggressive trimodality management; both prolonged disease-free interval and occasionally cure are possible.

**Men with Blastic Skeletal Metastases and Elevated PSA** Blastic bone-only metastasis is a rare presentation, and elevated serum PSA or tumor staining with PSA may provide confirmatory evidence of prostate cancer in these patients. Those with elevated levels are candidates for hormonal therapy for prostate cancer, although it is important to rule out other primary tumors (lung most common).

#### **MANAGEMENT OF DISSEMINATED CUP**

Patients who present with liver, brain, and adrenal metastatic disease usually have a poor prognosis. Beside

primary peritoneal carcinoma, carcinomatosis presenting as CUP in other settings is not uncommon. Gastric, appendicular, colon, pancreas, and cholangiocarcinoma are all possible primaries, and imaging, endoscopy, and pathologic data help in the evaluation.

Traditionally, platinum-based combination chemotherapy regimens have been used to treat patients with CUP. In a phase II study by Hainsworth and colleagues, 55 mostly chemotherapy-naïve patients were treated with paclitaxel, carboplatin, and oral etoposide every 3 weeks. The overall response rate was 47%, with median overall survival duration of 13.4 months. Briasoulis and colleagues reported similar response rates and survival durations in 77 patients with CUP who had been treated with paclitaxel and carboplatin. In this study, patients with nodal or pleural disease and women with peritoneal carcinomatosis had higher response rates and overall survival durations of 13 and 15 months, respectively. Studies incorporating newer agents, including gemcitabine, irinotecan, and targeted agents, are showing higher response rates. In a phase II randomized trial by Culine and colleagues, 80 patients were randomly assigned to receive gemcitabine with cisplatin or irinotecan with cisplatin; 78 patients were assessable for efficacy and toxicity. Objective responses were observed in 21 patients (55%) in the gemcitabine and cisplatin arm and in 15 patients (38%) in the irinotecan and cisplatin arm. The median survival was 8 months for gemcitabine and cisplatin and 6 months for irinotecan and cisplatin.

The role of second-line chemotherapy in CUP is poorly defined. Gemcitabine as a single agent has shown a partial response rate of 8%, and 25% of patients had minor responses or stable disease, with improved symptoms. Combination chemotherapy as a second- and third-line treatment may result in a slightly improved response.

Combination targeted therapy is being evaluated. Hainsworth and colleagues studied the combination of bevacizumab and erlotinib in 51 patients; 25% were chemotherapy-naïve and had advanced bone or liver metastases, and the rest had been previously treated with one or two chemotherapy regimens. Responses were noted in 4 patients (8%), and 30 patients (59%) experienced stable disease or a minor response. The median overall survival was 8.9 months, with 42% of patients alive at 1 year.

Historically, patients with CUP have been treated with “global” regimens that work for a variety of primary cancers. With incremental improved responses over the past decade in known cancer types, we anticipate overall better response rates with newer regimens for selected CUP patients. With a more robust immunohistochemical panel (directed approach) and new molecular data, one may be able to create a more tailored algorithm for CUP patients.

## SUMMARY

Patients with CUP should undergo a directed diagnostic search for the primary tumor on the basis of clinical and pathologic data. Subsets of patients have prognostically favorable disease, as defined by clinical or histologic criteria, and they may substantially benefit from aggressive treatment and expect prolonged survival. However, for most patients who present with advanced CUP, the prognosis remains poor, with early resistance to available cytotoxic therapy. Research into the metastatic phenotype will help us improve our understanding of CUP tumor biology. Whether the CUP clone is a distinct molecular genotype–phenotype that is different from metastases of known primary tumors remains to be elucidated. The identification of specific CUP-related molecular and biochemical targets may help exploit therapeutic targeted agents for this entity.

## FURTHER READINGS

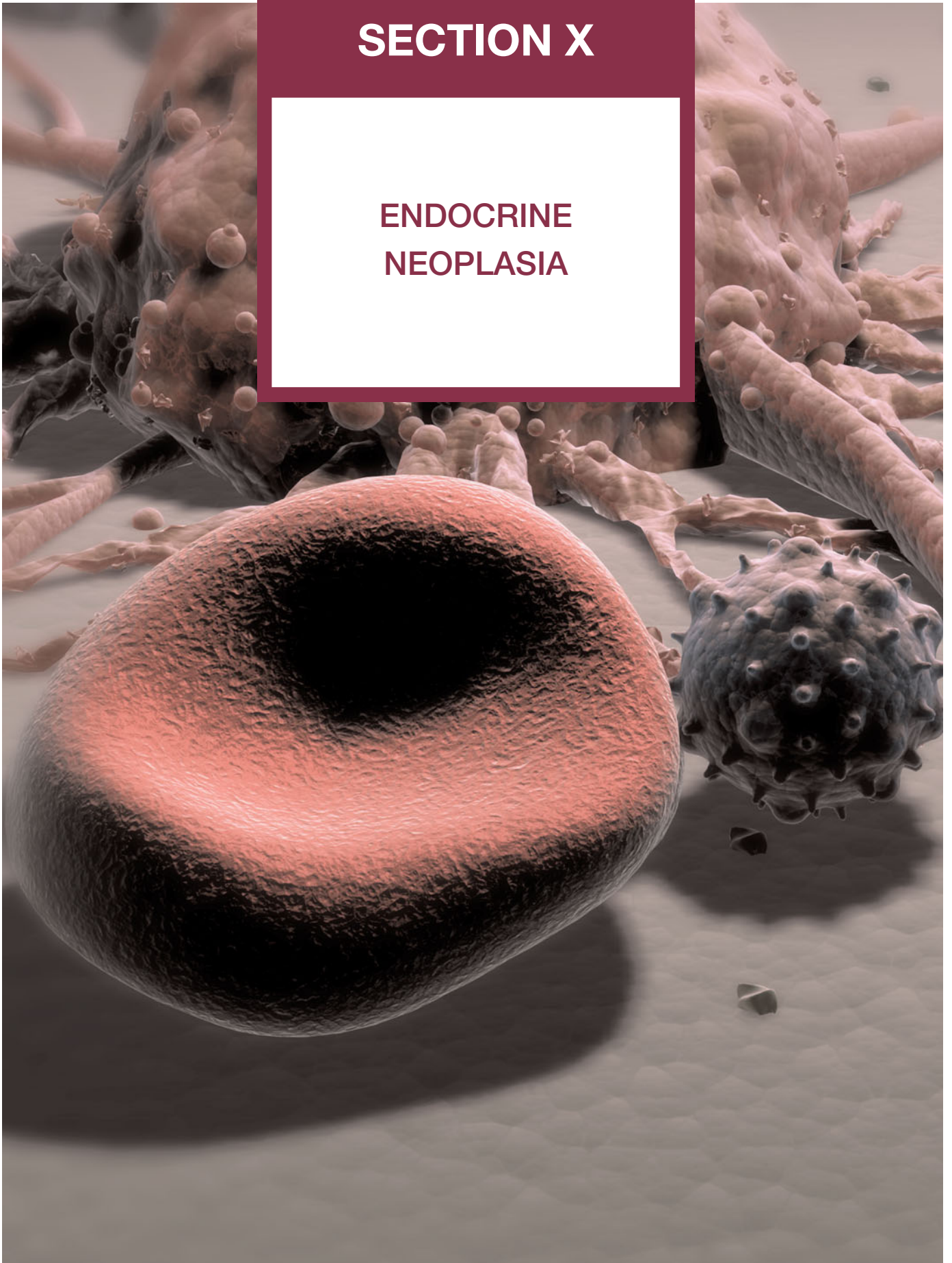
- ABBRUZZESE JL et al: The biology of unknown primary tumors. *Semin Oncol* 20:238, 1993
- BENDER RA, ERLANDER MG: Molecular classification of unknown primary cancer. *Semin Oncol* 36:38, 2009
- BUGAT R et al: Summary of the standards, options and recommendations for the management of patients with carcinoma of unknown primary site. *Br J Cancer* 89(Suppl 1):S59, 2003
- CULINE S et al: Cisplatin in combination with either gemcitabine or irinotecan in carcinomas of unknown primary site: Results of a randomized phase II study—trial for the French Study Group on Carcinomas of Unknown Primary (GEFCAPI 01). *J Clin Oncol* 21:3479, 2003
- DENNIS JL, OIEN KA: Hunting the primary: novel strategies for defining the origin of tumours. *J Pathol* 205:236, 2005
- GRECO FA, HAINSWORTH JD: One-hour paclitaxel, carboplatin, and extended-schedule etoposide in the treatment of carcinoma of unknown primary site. *Semin Oncol* 24(6 Suppl 19):S19, 1997
- GRECO FA, PAVLIDIS N: Treatment for patients with unknown primary carcinoma and unfavorable prognostic factors. *Semin Oncol* 36:65, 2009
- HAINSWORTH JD, FIZAZI K: Treatment for patients with unknown primary cancer and favorable prognostic factors. *Semin Oncol* 36:44, 2009
- KENDE AI et al: Expression of cytokeratins 7 and 20 in carcinomas of the gastrointestinal tract. *Histopathology* 42:137, 2003
- LOBINS R, FLOYD J: Small cell carcinoma of unknown primary. *Semin Oncol* 34:39, 2007
- OLSON JA Jr et al: Magnetic resonance imaging facilitates breast conservation for occult breast cancer. *Ann Surg Oncol* 7:411, 2000
- RUSTHOVEN KE et al: The role of fluorodeoxyglucose positron emission tomography in cervical lymph node metastases from an unknown primary tumor. *Cancer* 101:2641, 2004
- VARADHACHARY GR et al: Diagnostic strategies for unknown primary cancer. *Cancer* 100:1776, 2004
- VARADHACHARY GR, GRECO FA: Overview of patient management and future directions in unknown primary carcinoma. *Semin Oncol* 36:75, 2009

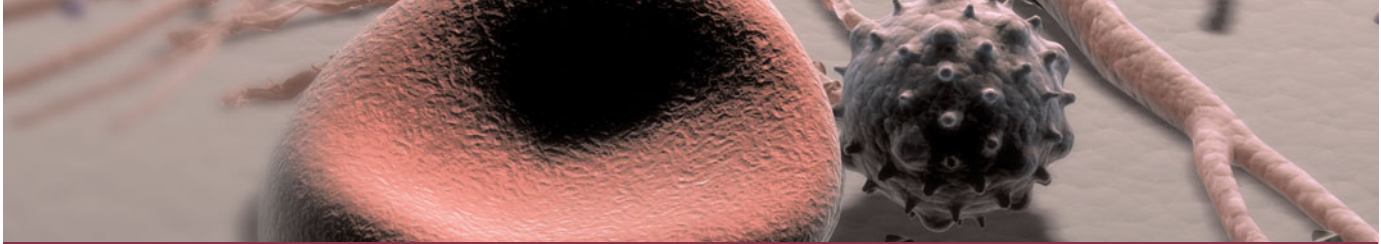


*This page intentionally left blank*

# SECTION X

## ENDOCRINE NEOPLASIA





## CHAPTER 45

# THYROID CANCER

J. Larry Jameson ■ Anthony P. Weetman

■ Thyroid Cancer	.571
Classification	.572
Pathogenesis and Genetic Basis	.572
Well-Differentiated Thyroid Cancer	.573
Anaplastic and Other Forms of Thyroid Cancer	.577
Medullary Thyroid Carcinoma	.577
■ Further Readings	.577

### Approach to the Patient: A THYROID NODULE

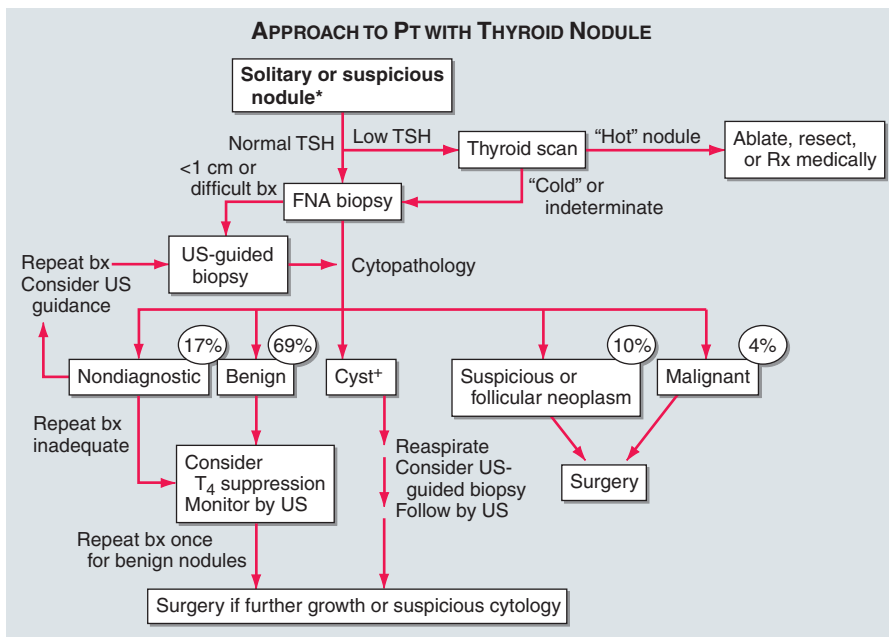
Palpable thyroid nodules are found in ~5% of adults, but the prevalence varies considerably worldwide. Given this high prevalence rate, it is common for the practitioner to identify thyroid nodules. The main goal of this evaluation is to identify, in a cost-effective manner, the small subgroup of individuals with malignant lesions.

As described in the text, nodules are more common in iodine-deficient areas, in women, and with aging. Most palpable nodules are >1 cm in diameter, but the ability to feel a nodule is influenced by its location within the gland (superficial versus deeply embedded), the anatomy of the patient's neck, and the experience of the examiner. More sensitive methods of detection, such as CT, thyroid ultrasound, and pathologic studies, reveal thyroid nodules in >20% of glands. The presence of these thyroid incidentalomas has led to much debate about how to detect nodules and which nodules to investigate further. Most authorities still rely on physical examination to detect thyroid nodules, reserving ultrasound for monitoring nodule size or as an aid in thyroid biopsy.

An approach to the evaluation of a solitary nodule is outlined in [Fig. 45-1](#). Most patients with thyroid nodules have normal thyroid function tests. Nonetheless, thyroid function should be assessed by measuring a

TSH level, which may be suppressed by one or more autonomously functioning nodules. If the TSH is suppressed, a radionuclide scan is indicated to determine if the identified nodule is “hot” because lesions with increased uptake are almost never malignant and FNA is unnecessary. Otherwise, FNA biopsy should be the first step in the evaluation of a thyroid nodule. FNA has good sensitivity and specificity when performed by physicians familiar with the procedure and when the results are interpreted by experienced cytopathologists. The technique is particularly good for detecting PTC. The distinction of benign and malignant follicular lesions is often not possible using cytology alone.

In several large studies, FNA biopsies yielded the following findings: 70% benign, 10% malignant or suspicious for malignancy, and 20% nondiagnostic or yielding insufficient material for diagnosis. Characteristic features of malignancy mandate surgery. A diagnosis of follicular neoplasm also warrants surgery because benign and malignant lesions cannot be distinguished based on cytopathology or frozen section. The management of patients with benign lesions is more variable. Many authorities advocate TSH suppression, whereas others monitor nodule size without suppression. With either approach, thyroid nodule size should be monitored, ideally using ultrasound. Repeat FNA is indicated if a nodule enlarges,

**FIGURE 45-1**

**Approach to the patient with a thyroid nodule.** See text and references for details. †About a third of nodules are cystic or mixed solid-cystic. US, ultrasound; TSH, thyroid-stimulating hormone; FNA, fine-needle aspiration.

and a second biopsy should be performed within 2–5 years to confirm the benign status of the nodule.

Nondiagnostic biopsies occur for many reasons, including a fibrotic reaction with relatively few cells available for aspiration, a cystic lesion in which cellular components reside along the cyst margin, or a nodule that may be too small for accurate aspiration. For these reasons, ultrasound-guided FNA is indicated when the FNA is repeated. Ultrasound is also increasingly used for initial biopsies in an effort to enhance nodule localization and the accuracy of sampling. Ultrasound characteristics are also useful for deciding which nodules to biopsy when multiple nodules are present. Sonographic characteristics suggestive of malignancy include microcalcifications, increased vascularity, and hypoechogenicity within the nodule.

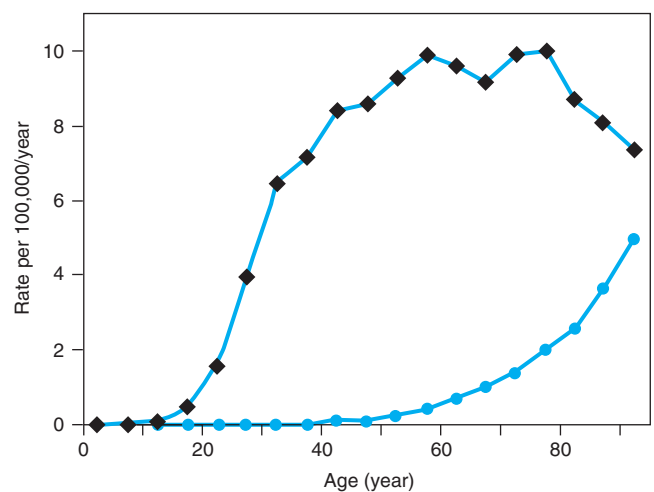
The evaluation of a thyroid nodule is stressful for most patients. They are concerned about the possibility of thyroid cancer, whether verbalized or not. It is constructive, therefore, to review the diagnostic approach and to reassure patients when no malignancy is found. When a suspicious lesion or thyroid cancer is identified, an explanation of the generally favorable prognosis and available treatment options should be provided.

## THYROID CANCER

Thyroid carcinoma is the most common malignancy of the endocrine system. Malignant tumors derived from the follicular epithelium are classified according to histologic features. Differentiated tumors, such as papillary

thyroid cancer (PTC) or follicular thyroid cancer (FTC), are often curable, and the prognosis is good for patients identified with early-stage disease. In contrast, anaplastic thyroid cancer (ATC) is aggressive, responds poorly to treatment, and is associated with a bleak prognosis.

The incidence of thyroid cancer (~9/100,000 per year) increases with age, plateauing after ~50 years of age (Fig. 45-2). Age is also an important prognostic factor—thyroid cancer at a young age (<20 years) or in older persons (>45 years) is associated with a worse prognosis. Thyroid cancer is twice as common in women as men, but male sex is associated with a worse prognosis. Additional important risk factors include a history of childhood

**FIGURE 45-2**

**Age-associated incidence (—◆—) and mortality (—●—) rates for invasive thyroid cancer.** [Adapted from LAG Ries et al (eds): *SEER Cancer Statistics Review, 1973–1996*, Bethesda, National Cancer Institute, 1999.]

**RISK FACTORS FOR THYROID CARCINOMA IN PATIENTS WITH THYROID NODULE**

History of head and neck irradiation	Family history of thyroid cancer or MEN 2
Age <20 or >45 years	Vocal cord paralysis, hoarse voice
Bilateral disease	Nodule fixed to adjacent structures
Increased nodule size (>4 cm)	Extrathyroidal extension
New or enlarging neck mass	Suspected lymph node involvement
Male sex	Iodine deficiency (follicular cancer)

**Note:** MEN, multiple endocrine neoplasia.

head or neck irradiation, large nodule size ( $\geq 4$  cm), evidence for local tumor fixation or invasion into lymph nodes, and the presence of metastases (**Table 45-1**).

Several unique features of thyroid cancer facilitate its management: (1) thyroid nodules are readily palpable, allowing early detection and biopsy by FNA; (2) iodine radioisotopes can be used to diagnose ( $^{123}\text{I}$ ) and treat ( $^{131}\text{I}$ ) differentiated thyroid cancer, reflecting the unique uptake of this anion by the thyroid gland; and (3) serum markers allow the detection of residual or recurrent disease, including the use of Tg levels for PTC and FTC and calcitonin for medullary thyroid cancer (MTC).

**CLASSIFICATION**

Thyroid neoplasms can arise in each of the cell types that populate the gland, including thyroid follicular cells, calcitonin-producing C cells, lymphocytes, and stromal and vascular elements, as well as metastases from other sites (**Table 45-2**). The American Joint Committee on Cancer (AJCC) has designated a staging system using the TNM classification (**Table 45-3**). Several other classification and staging systems are also widely used, some of which place greater emphasis on histologic features or risk factors such as age or gender.

**PATHOGENESIS AND GENETIC BASIS****Radiation**

Early studies of the pathogenesis of thyroid cancer focused on the role of external radiation, which predisposes to chromosomal breaks, presumably leading to genetic rearrangements and loss of tumor-suppressor genes. External radiation of the mediastinum, face, head, and neck region was administered in the past to treat an array of conditions, including acne and enlargement of the thymus, tonsils, and adenoids. Radiation exposure increases the risk of benign and malignant thyroid nodules, is associated with multicentric cancers, and shifts the incidence of thyroid cancer to an earlier age group.

**TABLE 45-2****CLASSIFICATION OF THYROID NEOPLASMS**

<b>Benign</b>	
Follicular epithelial cell adenomas	
Macrofollicular (colloid)	
Normofollicular (simple)	
Microfollicular (fetal)	
Trabecular (embryonal)	
Hürthle cell variant (oncocytic)	
<b>Malignant</b>	
<b>Follicular epithelial cell</b>	
Well-differentiated carcinomas	
Papillary carcinomas	80–90
Pure papillary	
Follicular variant	
Diffuse sclerosing variant	
Tall cell, columnar cell variants	
Follicular carcinomas	5–10
Minimally invasive	
Widely invasive	
Hürthle cell carcinoma (oncocytic)	
Insular carcinoma	
Undifferentiated (anaplastic) carcinomas	
<b>C cell (calcitonin-producing)</b>	
Medullary thyroid cancer	10
Sporadic	
Familial	
MEN2	
<b>Other malignancies</b>	
Lymphomas	1–2
Sarcomas	
Metastases	
Others	

**Note:** MEN, multiple endocrine neoplasia.

Radiation from nuclear fallout also increases the risk of thyroid cancer. Children seem more predisposed to the effects of radiation than adults. Of note, radiation derived from  $^{131}\text{I}$  therapy appears to contribute minimal increased risk of thyroid cancer.

**TSH and Growth Factors**

Many differentiated thyroid cancers express TSH receptors and therefore remain responsive to TSH. This observation provides the rationale for  $T_4$  suppression of TSH in patients with thyroid cancer. Residual expression of TSH receptors also allows TSH-stimulated uptake of  $^{131}\text{I}$  therapy (see later).

**Oncogenes and Tumor-Suppressor Genes**

Thyroid cancers are monoclonal in origin, consistent with the idea that they originate as a consequence of mutations that confer a growth advantage to a single

TABLE 45-3

THYROID CANCER CLASSIFICATION <sup>a</sup>		
<b>Papillary or Follicular Thyroid Cancers</b>		
	<45 years	>45 years
Stage I	Any T, any N, M0	T1, N0, M0
Stage II	Any T, any N, M1	T2 or T3, N0, M0
Stage III	—	T4, N0, M0
Stage IV	—	Any T, N1, M0 Any T, any N, M1
<b>Anaplastic Thyroid Cancer</b>		
Stage IV	All cases are stage IV	
<b>Medullary Thyroid Cancer</b>		
Stage I	T1, N0, M0	
Stage II	T2–T4, N0, M0	
Stage III	Any T, N1, M0	
Stage IV	Any T, any N, M1	

<sup>a</sup>Criteria include: T, the size and extent of the primary tumor (T1 ≤ 1 cm; 1 cm < T2 ≤ 4 cm; T3 >4 cm; T4 direct invasion through the thyroid capsule); N, the absence (N0) or presence (N1) of regional node involvement; M, the absence (M0) or presence (M1) of metastases.

**Source:** American Joint Committee on Cancer staging system for thyroid cancers using the TNM classification.

cell. In addition to increased rates of proliferation, some thyroid cancers exhibit impaired apoptosis and features that enhance invasion, angiogenesis, and metastasis. By analogy with the model of multistep carcinogenesis proposed for colon cancer (Chap. 23), thyroid neoplasms have been analyzed for a variety of genetic alterations, but without clear evidence of an ordered acquisition of somatic mutations as they progress from the benign to the malignant state. However, certain mutations are relatively specific for thyroid neoplasia, some of which correlate with histologic classification (Table 45-4).

Activating mutations of the TSH-R and the  $G_{s\alpha}$  subunit are associated with autonomously functioning nodules. Although these mutations induce thyroid cell growth, this type of nodule is almost always benign.

Activation of the RET-RAS-BRAF signaling pathway is seen in most PTCs, although the types of mutations are heterogeneous. A variety of rearrangements involving the *RET* gene on chromosome 10 brings this receptor tyrosine kinase under the control of other promoters, leading to receptor overexpression. *RET* rearrangements occur in 20–40% of PTCs in different series and were observed with increased frequency in tumors developing after the Chernobyl radiation accident. Rearrangements in PTC have also been observed for another tyrosine kinase gene, *TRK1*, which is located on chromosome 1. To date, the identification of PTC with *RET* or *TRK1* rearrangements has not proven useful for predicting prognosis or treatment responses. *BRAF* mutations appear to be the most common genetic alteration in PTC. These mutations activate

the kinase, which stimulates the mitogen-activated protein MAP kinase (MAPK) cascade. *RAS* mutations, which also stimulate the MAPK cascade, are found in about 20–30% of thyroid neoplasms, including both PTC and FTC. Of note, simultaneous *RET*, *BRAF*, and *RAS* mutations do not occur in the same tumor, suggesting that activation of the MAPK cascade is critical for tumor development, independent of the step that initiates the cascade.

As noted, *RAS* mutations also occur in FTCs. In addition, a rearrangement of the thyroid developmental transcription factor PAX8 with the nuclear receptor PPAR $\gamma$  is identified in a significant fraction of FTCs. Loss of heterozygosity of 3p or 11q, consistent with deletions of tumor-suppressor genes, is also common in FTCs.

Most of the mutations seen in differentiated thyroid cancers have also been detected in ATCs. Mutations in CTNNB1, which encodes  $\beta$ -catenin, occur in about two-thirds of ATCs, but not in PTC or FTC. Mutations of the tumor suppressor p53 also play an important role in the development of ATC. Because p53 plays a role in cell cycle surveillance, DNA repair, and apoptosis, its loss may contribute to the rapid acquisition of genetic instability as well as poor treatment responses (Chap. 24) (Table 45-4).

MTC, when associated with multiple endocrine neoplasia (MEN) type 2, harbors an inherited mutation of the *RET* gene. Unlike the rearrangements of *RET* seen in PTC, the mutations in MEN2 are point mutations that induce constitutive activity of the tyrosine kinase (Chap. 47). MTC is preceded by hyperplasia of the C cells, raising the likelihood that as-yet-unidentified “second hits” lead to cellular transformation. A subset of sporadic MTC contain somatic mutations that activate *RET*.

## WELL-DIFFERENTIATED THYROID CANCER

### Papillary

PTC is the most common type of thyroid cancer, accounting for 70–90% of well-differentiated thyroid malignancies. Microscopic PTC is present in up to 25% of thyroid glands at autopsy, but most of these lesions are very small (several millimeters) and are not clinically significant. Characteristic cytologic features of PTC help make the diagnosis by FNA or after surgical resection; these include psammoma bodies, cleaved nuclei with an “orphan-Annie” appearance caused by large nucleoli, and the formation of papillary structures.

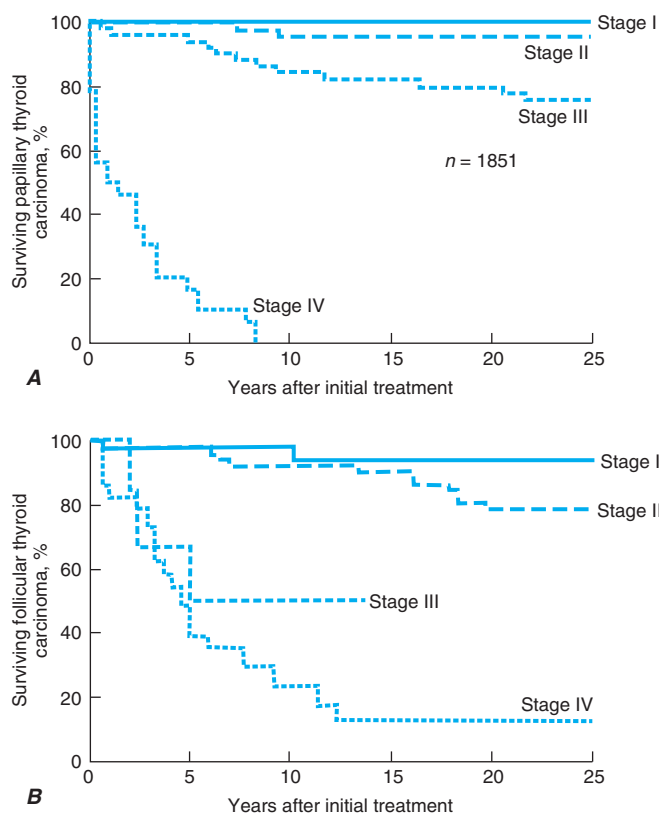
PTC tends to be multifocal and to invade locally within the thyroid gland as well as through the thyroid capsule and into adjacent structures in the neck. It has a propensity to spread via the lymphatic system but can metastasize hematogenously as well, particularly to bone and lung. Because of the relatively slow growth of the tumor, a significant burden of pulmonary metastases

**GENETIC ALTERATIONS IN THYROID NEOPLASIA**

GENE/PROTEIN	TYPE OF GENE	CHROMOSOMAL LOCATION	GENETIC ABNORMALITY	TUMOR
TSH receptor	GPCR receptor	14q31	Point mutations	Toxic adenoma, differentiated carcinomas
G <sub>sα</sub>	G protein	20q13.2	Point mutations	Toxic adenoma, differentiated carcinomas
RET/PTC	Receptor tyrosine kinase	10q11.2	Rearrangements PTC1: (inv(10)q11.2q21) PTC2: (t(10;17)(q11.2;q23)) PTC3: ELE1/TK	PTC
RET	Receptor tyrosine kinase	10q11.2	Point mutations	MEN 2, medullary thyroid cancer
BRAF	MEK kinase	7q24	Point mutations, rearrangements	PTC
TRK	Receptor tyrosine kinase	1q23-24	Rearrangements	Multinodular goiter, papillary thyroid cancer
RAS	Signal transducing p21	Hras 11p15.5 Kras 12p12.1; Nras 1p13.2	Point mutations	Differentiated thyroid carcinoma, adenomas
p53	Tumor suppressor, cell cycle control, apoptosis	17p13	Point mutations Deletion, insertion	Anaplastic cancer
APC	Tumor suppressor, adenomatous polyposis coli gene	5q21-q22	Point mutations	Anaplastic cancer, also associated with familial polyposis coli
p16 (MTS1, CDKN2A)	Tumor suppressor, cell cycle control	9p21	Deletions	Differentiated carcinomas
p21/WAF	Tumor suppressor, cell cycle control	6p21.2	Overexpression	Anaplastic cancer
MET	Receptor tyrosine kinase	7q31	Overexpression	Follicular thyroid cancer
c-MYC	Receptor tyrosine kinase	8q24.12.-13	Overexpression	Differentiated carcinoma
PTEN	Phosphatase	10q23	Point mutations	PTC in Cowden's syndrome (multiple hamartomas, breast tumors, gastrointestinal polyps, thyroid tumors)
CTNNB1	β-Catenin	3p22	Point mutations	Anaplastic cancer
Loss of heterozygosity (LOH)	?Tumor suppressors	3p; 11q13 Other loci	Deletions	Differentiated thyroid carcinomas, anaplastic cancer
PAX8-PPAR <sub>γ</sub> 1	Transcription factor Nuclear receptor fusion	t(2;3)(q13;p25)	Translocation	Follicular adenoma or carcinoma

**Note:** TSH, thyroid-stimulating hormone; G<sub>sα</sub>, G-protein stimulating α-subunit; RET, rearranged during transfection proto-oncogene; PTC, papillary thyroid cancer; TRK, tyrosine kinase receptor; RAS, rat sarcoma proto-oncogene; p53, p53 tumor suppressor gene; MET, met proto-oncogene (hepatocyte growth factor receptor); c-MYC, cellular homologue of myelocytomatosis virus proto-oncogene; PTEN, phosphatase and tensin homologue; APC, adenomatous polyposis coli; MTS, multiple tumor suppressor; CDKN2A, cyclin-dependent kinase inhibitor 2A; P21, p21 tumor suppressor; WAF, wild-type p53 activated fragment; GPCR, G protein-coupled receptor; ELE1/TK, ret-activating gene ele1/tyrosine kinase; MEN 2, multiple endocrine neoplasia-2; PAX8, Paired domain transcription factor; PPAR<sub>γ</sub>1, peroxisome-proliferator activated receptor γ1; BRAF, v-raf homologue, B1; MEK, mitogen extracellular signal-regulated kinase.

**Source:** Adapted with permission from P Kopp, JL Jameson, in JL Jameson (ed): *Principles of Molecular Medicine*. Totowa, NJ, Humana Press, 1998.



**FIGURE 45-3**

**Survival rates in patients with differentiated thyroid cancer.**

**A.** Papillary cancer, cohort of 1851 patients. I, 1107 (60%); II, 408 (22%); III, 312 (17%); IV, 24 (1%);  $n = 1185$ . **B.** Follicular cancer, cohort of 153 patients. I, 42 (27%); II, 82 (54%); III, 6 (4%); IV, 23 (15%);  $n = 153$ . [Adapted from PR Larsen et al: *William's Textbook of Endocrinology, 9th ed, JD Wilson et al (eds). Philadelphia, Saunders, 1998, pp 389–575, with permission.*]

may accumulate, sometimes with remarkably few symptoms. The prognostic implication of lymph node spread is debated. Lymph node involvement by thyroid cancer can be remarkably well tolerated but appears to increase the risk of recurrence and mortality, particularly in older patients. The staging of PTC by the TNM system is outlined in Table 45-3. Most papillary cancers are identified in the early stages (>80% stages I or II) and have an excellent prognosis, with survival curves similar to expected survival (Fig. 45-3A). Mortality is markedly increased in stage IV disease (distant metastases), but this group comprises only ~1% of patients. The treatment of PTC is described later.

### Follicular

The incidence of FTC varies widely in different parts of the world; it is more common in iodine-deficient regions. FTC is difficult to diagnose by FNA because the distinction between benign and malignant follicular neoplasms rests largely on evidence of invasion into vessels, nerves, or adjacent structures. FTC tends to spread by hematogenous routes leading to bone, lung, and central nervous

system metastases. Mortality rates associated with FTC are less favorable than for PTC, in part because a larger proportion of patients present with stage IV disease (Fig. 45-3B). Poor prognostic features include distant metastases, age >50 years, primary tumor size >4 cm, Hürthle cell histology, and the presence of marked vascular invasion.

### Rx Treatment: WELL-DIFFERENTIATED THYROID CANCER

**SURGERY** All well-differentiated thyroid cancers should be surgically excised. In addition to removing the primary lesion, surgery allows accurate histologic diagnosis and staging, and multicentric disease is commonly found in the contralateral thyroid lobe. Lymph node spread can also be assessed at the time of surgery, and involved nodes can be removed. Recommendations about the extent of surgery vary for stage I disease because survival rates are similar for lobectomy and near-total thyroidectomy. Lobectomy is associated with a lower incidence of hypoparathyroidism and injury to the recurrent laryngeal nerves. However, it is not possible to monitor Tg levels or to perform whole-body  $^{131}\text{I}$  scans in the presence of the residual lobe. Moreover, if final staging or subsequent follow-up indicates the need for radioiodine scanning or treatment, repeat surgery is necessary to remove the remaining thyroid tissue. Therefore, near-total thyroidectomy is preferable in almost all patients; complication rates are acceptably low if the surgeon is highly experienced in the procedure. Postsurgical radioablation of the remnant thyroid tissue is increasingly being used because it may destroy remaining or multifocal thyroid carcinoma, and it facilitates the use of Tg determinations and radioiodine scanning for long-term follow-up by eliminating residual normal or neoplastic tissue.

**TSH SUPPRESSION THERAPY** Because most tumors are still TSH-responsive, levothyroxine suppression of TSH is a mainstay of thyroid cancer treatment. Although TSH suppression clearly provides therapeutic benefit, there are no prospective studies that identify the optimal level of TSH suppression. A reasonable goal is to suppress TSH as much as possible without subjecting the patient to unnecessary side effects from excess thyroid hormone, such as atrial fibrillation, osteopenia, anxiety, and other manifestations of thyrotoxicosis. For patients at low risk of recurrence, TSH should be suppressed into the low but detectable range (0.1–0.5 IU/L). For patients at high risk of recurrence or with known metastatic disease, complete TSH suppression is indicated if there are no strong contraindications to mild thyrotoxicosis. In this instance, unbound  $\text{T}_4$  must also be monitored to avoid excessive treatment.



**RADIOIODINE TREATMENT** Well-differentiated thyroid cancer still incorporates radioiodine, although less efficiently than normal thyroid follicular cells. Radioiodine uptake is determined primarily by expression of the NIS and is stimulated by TSH, requiring expression of the TSH-R. The retention time for radioactivity is influenced by the extent to which the tumor retains differentiated functions such as iodide trapping and organification. After near-total thyroidectomy, substantial thyroid tissue often remains, particularly in the thyroid bed and surrounding the parathyroid glands. Consequently,  $^{131}\text{I}$  ablation is necessary to eliminate remaining normal thyroid tissue and to treat residual tumor cells.

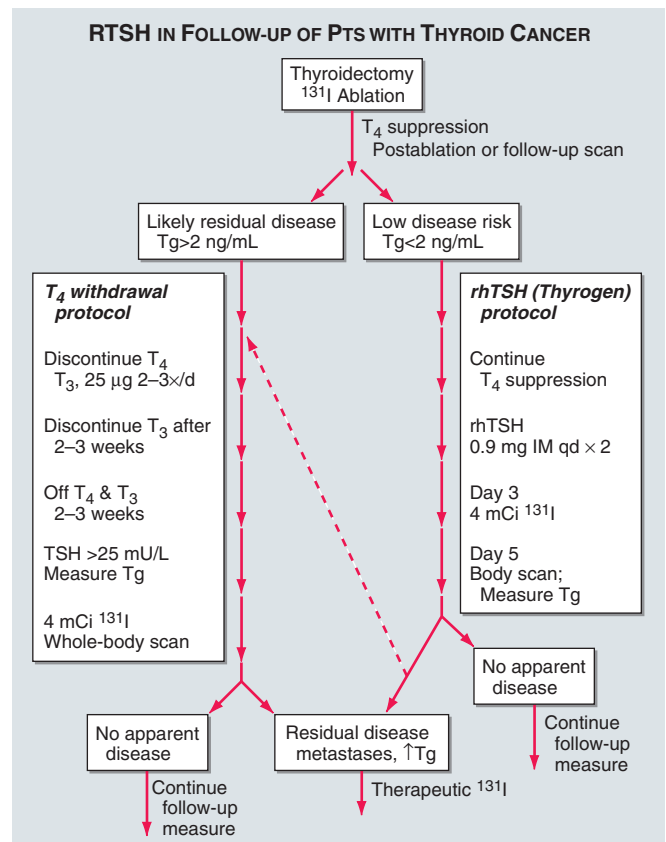
**Indications** The use of therapeutic doses of radioiodine remains an area of controversy in thyroid cancer management. However, postoperative thyroid ablation and radioiodine treatment of known residual PTC or FTC clearly reduces recurrence rates but has a smaller impact on mortality, particularly in patients at relatively low risk. This low-risk group includes most patients with stage 1 PTC with primary tumors <1.5 cm in size. For patients with larger papillary tumors, spread to the adjacent lymph nodes, FTC, or evidence of metastases, thyroid ablation and radioiodine treatment are generally indicated.

**$^{131}\text{I}$  Thyroid Ablation and Treatment** As noted earlier, the decision to use  $^{131}\text{I}$  for thyroid ablation should be coordinated with the surgical approach because radioablation is much more effective when there is minimal remaining normal thyroid tissue. A typical strategy is to treat the patient for several weeks postoperatively with liothyronine (25  $\mu\text{g}$  bid or tid), followed by thyroid hormone withdrawal. Ideally, the TSH level should increase to >50 IU/L over 3–4 weeks. The level to which TSH rises is dictated largely by the amount of normal thyroid tissue remaining postoperatively. Recombinant human TSH (rhTSH) has also been used to enhance  $^{131}\text{I}$  uptake for postsurgical ablation. It appears to be at least as effective as thyroid hormone withdrawal and should be particularly useful as residual thyroid tissue prevents an adequate endogenous TSH rise. rhTSH is currently approved for postoperative ablation in Europe but not in the United States.

A pretreatment scanning dose of  $^{131}\text{I}$  [usually 111–185 MBq (3–5 mCi)] can reveal the amount of residual tissue and provides guidance about the dose needed to accomplish ablation. However, because of concerns about radioactive “stunning” that impairs subsequent treatment, there is a trend to avoid pretreatment scanning and to proceed directly to ablation, unless there is suspicion that the amount of residual tissue will alter therapy. A maximum outpatient  $^{131}\text{I}$  dose is 1110 MBq (29.9 mCi) in the United States, although ablation is often more complete using greater doses [1850–3700

MBq (50–100 mCi)]. Patients should be placed on a low-iodine diet (<50  $\mu\text{g}/\text{d}$  urinary iodine) to increase radioiodine uptake. In patients with known residual cancer, the larger doses ensure thyroid ablation and may destroy remaining tumor cells. A whole-body scan following the high-dose radioiodine treatment is useful to identify possible metastatic disease.

**Follow-Up Whole-Body Thyroid Scanning and Thyroglobulin Determinations** An initial whole-body scan should be performed ~6 months after thyroid ablation. The strategy for follow-up management of thyroid cancer has been altered by the availability of rhTSH to stimulate  $^{131}\text{I}$  uptake and by the improved sensitivity of Tg assays to detect residual or recurrent disease. A scheme for using either rhTSH or thyroid hormone withdrawal for thyroid scanning is summarized in Fig. 45-4. After thyroid ablation, rhTSH can be used in follow-up to stimulate Tg and  $^{131}\text{I}$  uptake without subjecting patients to thyroid hormone withdrawal and its associated symptoms of hypothyroidism as well as the risk of tumor growth after prolonged TSH stimulation. Alternatively, in patients who are likely to require  $^{131}\text{I}$  treatment, the traditional approach of thyroid hormone withdrawal can be used to increase TSH. This



**FIGURE 45-4** Use of recombinant thyroid-stimulating hormone (TSH) in the follow-up of patients with thyroid cancer. Tg, thyroglobulin; rhTSH, recombinant human TSH.

involves switching patients from levothyroxine ( $T_4$ ) to the more rapidly cleared hormone liothyronine ( $T_3$ ), thereby allowing TSH to increase more quickly. Because TSH stimulates Tg levels, Tg measurements should be obtained after administration of rhTSH or when TSH levels have risen after thyroid hormone withdrawal.

In low-risk patients who have no clinical evidence of residual disease after ablation and a basal Tg  $<1$  ng/mL, increasing evidence supports the use of rhTSH-stimulated Tg levels 1 year after ablation, without the need for radioiodine scanning. If stimulated Tg levels are low ( $<2$  ng/mL) and, ideally undetectable, these patients can be managed with suppressive therapy and measurements of unstimulated Tg every 6–12 months. The absence of Tg antibodies should be confirmed in these patients. However, patients with residual disease on whole-body scanning or those with elevated Tg levels require additional  $^{131}\text{I}$  therapy. In addition, most authorities advocate radioiodine treatment for scan-negative, Tg-positive (Tg  $>5$ – $10$  ng/mL) patients because many derive therapeutic benefit from a large dose of  $^{131}\text{I}$ .

In addition to radioiodine, external beam radiotherapy is also used to treat specific metastatic lesions, particularly when they cause bone pain or threaten neurologic injury (e.g., vertebral metastases).

## ANAPLASTIC AND OTHER FORMS OF THYROID CANCER

### Anaplastic Thyroid Cancer

As noted earlier, ATC is a poorly differentiated and aggressive cancer. The prognosis is poor, and most patients die within 6 months of diagnosis. Because of the undifferentiated state of these tumors, the uptake of radioiodine is usually negligible, but it can be used therapeutically if there is residual uptake. Chemotherapy has been attempted with multiple agents, including anthracyclines and paclitaxel, but it is usually ineffective. External beam radiation therapy can be attempted and continued if tumors are responsive.

### Thyroid Lymphoma

Lymphoma in the thyroid gland often arises in the background of Hashimoto's thyroiditis. A rapidly expanding thyroid mass suggests the possibility of this diagnosis. Diffuse large-cell lymphoma is the most common type in the thyroid. Biopsies reveal sheets of lymphoid cells that can be difficult to distinguish from small cell lung cancer or ATC. These tumors are often highly sensitive to external radiation. Surgical resection should be avoided as initial therapy because it may spread disease that is otherwise localized to the thyroid. If staging indicates disease outside of the thyroid, treatment should follow guidelines used for other forms of lymphoma (Chap. 15).

## MEDULLARY THYROID CARCINOMA

MTC can be sporadic or familial and accounts for ~5–10% of thyroid cancers. There are three familial forms of MTC: MEN 2A, MEN 2B, and familial MTC without other features of MEN (Chap. 47). In general, MTC is more aggressive in MEN 2B than in MEN 2A, and familial MTC is more aggressive than sporadic MTC. Elevated serum calcitonin provides a marker of residual or recurrent disease. It is reasonable to test all patients with MTC for *RET* mutations because genetic counseling and testing of family members can be offered to those individuals who test positive for mutations.

The management of MTC is primarily surgical. Unlike tumors derived from thyroid follicular cells, these tumors do not take up radioiodine. External radiation treatment and chemotherapy may provide palliation in patients with advanced disease (Chap. 47).

## FURTHER READINGS

- ABALOVICH M et al: Management of thyroid dysfunction during pregnancy and postpartum: An Endocrine Society Clinical Practice Guideline. *J Clin Endocrinol Metab* 92(Suppl):S1, 2007
- COOPER DS: Antithyroid drugs. *N Engl J Med* 352:905, 2005
- et al: Management guidelines for patients with thyroid nodules and differentiated thyroid cancer. *Thyroid* 16:1, 2006
- DE FELICE M, DI LAURO R: Thyroid development and its disorders: Genetics and molecular mechanisms. *Endo Rev* 25:722, 2004
- DEGROOT LJ et al: Thyroid gland (Part 10, Vol 2), in *Endocrinology*, 5th ed, LJ DeGroot, JL Jameson (eds). Philadelphia, Elsevier Saunders, 2006
- ESCOBAR-MORREALE HF et al: Treatment of hypothyroidism with combinations of levothyroxine plus liothyronine. *J Clin Endocrinol Metab* 90:4946, 2005
- GHARIB H et al: Subclinical thyroid dysfunction: a joint statement on management from the American Association of Clinical Endocrinologists, the American Thyroid Association, and the Endocrine Society. *J Clin Endocrinol Metab* 90:581, 2005
- GRUTERS A et al: Molecular genetic defects in congenital hypothyroidism. *Eur J Endocrinol* 151(Suppl 3):U39, 2004
- KONDO T et al: Pathogenetic mechanisms in thyroid follicular cell neoplasia. *Nat Rev Cancer* 6:292, 2006
- MACHENS A et al: Constitutive RET tyrosine kinase activation in hereditary medullary thyroid cancer: clinical opportunities. *J Intern Med* 266:114, 2009
- MEHANNA HM et al: Investigating the thyroid nodule. *BMJ* 338:b733, 2009
- PEARCE EN: Diagnosis and management of thyrotoxicosis. *BMJ* 332:1369, 2006
- RINGEL MD: Molecular markers of aggressiveness of thyroid cancer. *Curr Opin Endocrinol Diabetes Obes* 2009; July 3 (Epub ahead of print)
- ROBERTS CGP, LADENSON PW: Hypothyroidism. *Lancet* 363:793, 2004
- SEABERG RM et al: Influence of previous radiation exposure on pathologic features and clinical outcome in patients with thyroid cancer. *Arch Otolaryngol Head Neck Surg* 235:355, 2009
- WEETMAN AP: Cellular immune responses in autoimmune thyroid disease. *Clin Endocrinol* 61:405, 2004
- YING AK et al: Thyroid cancer in young adults. *Semin Oncol* 36:258, 2009



## CHAPTER 46

# ENDOCRINE TUMORS OF THE GASTROINTESTINAL TRACT AND PANCREAS

Robert T. Jensen

■ General Features of Gastrointestinal (GI) Neuroendocrine Tumors . . . . .	.578
■ Classification/Pathology/Tumor Biology of NETs . . . . .	.578
■ Carcinoid Tumors and Carcinoid Syndrome . . . . .	.584
Characteristics of the Most Common GI Carcinoid Tumors . . . . .	.584
Carcinoid Tumors without the Carcinoid Syndrome . . . . .	.585
Carcinoid Tumors with Systemic Symptoms	
Due to Secreted Products . . . . .	.585
Carcinoid Syndrome . . . . .	.586
Diagnosis of the Carcinoid Syndrome and Carcinoid Tumors . . . . .	.587
■ Pancreatic Endocrine Tumors . . . . .	.589
Gastrinoma (Zollinger-Ellison Syndrome) . . . . .	.590
Insulinomas . . . . .	.591
Glucagonomas . . . . .	.592
Somatostatinoma Syndrome . . . . .	.592
VIPomas . . . . .	.592
Nonfunctional Pancreatic Endocrine Tumors . . . . .	.593
GRFomas . . . . .	.594
Other Rare Pancreatic Endocrine Tumor Syndromes . . . . .	.594
■ Tumor Localization . . . . .	.594
■ Further Readings . . . . .	.596

### GENERAL FEATURES OF GASTROINTESTINAL (GI) NEUROENDOCRINE TUMORS

Gastrointestinal neuroendocrine tumors (NETs) are derived from the diffuse neuroendocrine system of the GI tract, which is composed of amine- and acid-producing cells with different hormonal profiles, depending on the site of origin. The tumors they produce can be divided into carcinoid tumors and pancreatic endocrine tumors (PETs). These tumors were originally classified as APUDomas (for *amine precursor uptake and decarboxylation*), as were pheochromocytomas, melanomas, and medullary thyroid carcinomas because they share certain cytochemical features as well as various pathologic, biologic, and molecular features (Table 46-1). It was originally proposed that APUDomas had a similar embryonic origin from neural crest cells, but it is now known the peptide-secreting cells are not of neuroectodermal origin. Nevertheless, the concept is useful because the tumors have important similarities as well as some differences (Table 46-1).

### CLASSIFICATION/PATHOLOGY/TUMOR BIOLOGY OF NETs

NETs are generally composed of monotonous sheets of small round cells with uniform nuclei; mitoses are uncommon. They can be tentatively identified on routine histology; however, these tumors are now principally recognized by their histologic staining patterns due to shared cellular proteins. Historically, silver staining was used and tumors were classified as showing an argentaffin reaction if they took up and reduced silver, or as being argyrophilic if they did not reduce it. More recently, immunocytochemical localization of chromogranins (A, B, C), neuron-specific enolase, or synaptophysin, which are all neuroendocrine cell markers, are used (Table 46-1). Chromogranin A is currently the most widely used.

Ultrastructurally, these tumors possess electron-dense neurosecretory granules and frequently contain small clear vesicles that correspond to synaptic vesicles of neurons. NETs synthesize numerous peptides, growth factors, and bioactive amines that may be ectopically secreted, giving rise to a specific clinical syndrome (Table 46-2). The

TABLE 46-1

GENERAL CHARACTERISTICS OF GI NEUROENDOCRINE TUMORS [CARCINOIDS, PANCREATIC ENDOCRINE TUMORS (PETs)]	
I. Share general neuroendocrine cell markers	<p>A. Chromogranins (A, B, C) are acidic monomeric soluble proteins found in the large secretory granules; chromogranin A is most widely used.</p> <p>B. Neuron-specific enolase (NSE) is the <math>\gamma</math>-<math>\gamma</math> dimer of the enzyme enolase and is a cytosolic marker of neuroendocrine differentiation.</p> <p>C. Synaptophysin is an integral membrane glycoprotein of 38,000 molecular weight found in small vesicles of neurons and neuroendocrine tumors.</p>
II. Pathologic similarities	<p>A. All are APUDomas showing amine precursor uptake and decarboxylation</p> <p>B. Ultrastructurally they have dense-core secretory granules (&gt;80 nm).</p> <p>C. Histologically appear similar with few mitoses and uniform nuclei</p> <p>D. Frequently synthesize multiple peptides/amines, which can be detected immunocytochemically but may not be secreted</p> <p>E. Presence or absence of clinical syndrome or type cannot be predicted by immunocytochemical studies.</p> <p>F. Histologic classifications do not predict biologic behavior; only invasion or metastases establishes malignancy.</p>
III. Similarities of biologic behavior	<p>A. Generally slow growing, but a proportion is aggressive.</p> <p>B. Secrete biologically active peptides/amines, which can cause clinical symptoms.</p> <p>C. Generally have high densities of somatostatin receptors, which are used for both localization and treatment.</p>
IV. Similarities/differences in molecular abnormalities	<p>A. Similarities</p> <ol style="list-style-type: none"> <li>1. Uncommon—alterations in common oncogenes (<i>ras</i>, <i>jun</i>, <i>fos</i>, etc).</li> <li>2. Uncommon—alterations in common tumor-suppressor genes (p53, retinoblastoma).</li> <li>3. Alterations at MEN1 locus (11q13) and p16<sup>INK4a</sup> (9p21) occur in a proportion (10–30%).</li> <li>4. Methylation of various genes occurs in 40–87% (<i>ras</i>-associated domain family I, p14, p16, O<sup>6</sup> methyl guanosine methyltransferase, retinoic acid receptor <math>\beta</math>).</li> </ol> <p>B. Differences</p> <ol style="list-style-type: none"> <li>1. PETs—loss of 3p (8–47%), 3q (8–41%), 11q (21–62%), 6q (18–68%). Gains at 17q (10–55%), 7q (16–68%).</li> <li>2. Carcinoids—loss of 18q (38–67%) &gt;18p (33–43%) &gt;9p, 16q21 (21–23%). Gains at 17q, 19p (57%).</li> </ol>

TABLE 46-2

GI NEUROENDOCRINE TUMOR SYNDROMES						
NAME	BIOLOGICALLY ACTIVE PEPTIDE(S) SECRETED	INCIDENCE (NEW CASES/10 <sup>6</sup> POPULATION/YEAR)	TUMOR LOCATION	MALIGNANT, %	ASSOCIATED WITH MEN1, %	MAIN SYMPTOMS/SIGNS
<b>Established Specific Functional Syndrome</b>						
Carcinoid tumor						
Carcinoid syndrome	Serotonin, possibly tachykinins, motilin, prostaglandins	0.5–2	Midgut (75–87%) Foregut (2–33%) Hindgut (1–8%) Unknown (2–15%)	95–100	Rare	Diarrhea (32–84%) Flushing (63–75%) Pain (10–34%) Asthma (4–18%) Heart disease (11–41%)
Pancreatic endocrine tumor						
Zollinger-Ellison syndrome	Gastrin	0.5–1.5	Duodenum (70%) Pancreas (25%) Other sites (5%)	60–90	20–25	Pain (79–100%) Diarrhea (30–75%) Esophageal symptoms (31–56%)
Insulinoma	Insulin	1–2	Pancreas (>99%)	<10	4–5	Hypoglycemic symptoms (100%)

(Continued)

## GI NEUROENDOCRINE TUMOR SYNDROMES

NAME	BIOLOGICALLY ACTIVE PEPTIDE(S) SECRETED	INCIDENCE (NEW CASES/10 <sup>6</sup> POPULATION/YEAR)	TUMOR LOCATION	MALIGNANT, %	ASSOCIATED WITH MEN1, %	MAIN SYMPTOMS/SIGNS
VIPoma (Verner-Morrison syndrome, pancreatic cholera, WDHA)	Vasoactive intestinal peptide	0.05–0.2	Pancreas (90%, adult) Other (10%, neural, adrenal, periganglionic)	40–70	6	Diarrhea (90–100%) Hypokalemia (80–100%) Dehydration (83%)
Glucagonoma	Glucagon	0.01–0.1	Pancreas (100%)	50–80	1–20	Rash (67–90%) Glucose intolerance (38–87%) Weight loss (66–96%)
Somatostatinoma	Somatostatin	Rare	Pancreas (55%) Duodenum/jejunum (44%)	>70	45	Diabetes mellitus (63–90%) Cholelithiasis (65–90%) Diarrhea (35–90%) Acromegaly (100%)
GRFoma	Growth hormone-releasing hormone	Unknown	Pancreas (30%) Lung (54%) Jejunum (7%) Other (13%)	>60	16	Diabetes mellitus (63–90%) Cholelithiasis (65–90%) Diarrhea (35–90%) Acromegaly (100%)
ACTHoma	ACTH	Rare	Pancreas (4–16% all ectopic Cushing's)	>95	Rare	Cushing's syndrome (100%)
PET causing carcinoid syndrome	Serotonin, ? tachykinins	Rare (43 cases)	Pancreas (<1% all carcinoids)	60–88	Rare	Same as carcinoid syndrome above
PET causing hypercalcemia	PTHrP, others unknown	Rare	Pancreas (rare cause of hypercalcemia)	84	Rare	Abdominal pain due to hepatic metastases
<b>Possible Specific Functional Syndrome</b>						
PET secreting calcitonin	Calcitonin	Rare	Pancreas (rare cause of hypercalcitonemia)	>80	16	Diarrhea (50%)
PET secreting renin	Renin	Rare	Pancreas	Unknown	No	Hypertension
PET secreting luteinizing hormone	Luteinizing hormone	Rare	Pancreas	Unknown	No	Anovulation, virilization (female); reduced libido (male)
PET secreting erythropoietin	Erythropoietin	Rare	Pancreas	100	No	Polycythemia
<b>No Functional Syndrome</b>						
PPoma/nonfunctional	None	1–2	Pancreas (100%)	>60	18–44	Weight loss (30–90%) Abdominal mass (10–30%) Pain (30–95%)

**Note:** MEN, multiple endocrine neoplasia; VIPoma, tumor secreting vasoactive intestinal peptide; WDHA, watery diarrhea, hypokalemia, and achlorhydria syndrome; ACTH, adrenocorticotropic hormone; PET, pancreatic endocrine tumor; PTHrP, parathyroid hormone-related peptide; PPoma, tumor secreting pancreatic polypeptide.

TABLE 46-3

## CARCINOID TUMOR LOCATION, FREQUENCY OF METASTASES, AND ASSOCIATION WITH THE CARCINOID SYNDROME

	LOCATION (% OF TOTAL)	INCIDENCE OF METASTASES	INCIDENCE OF CARCINOID SYNDROME
Foregut			
Esophagus	<0.1	—	—
Stomach	4.6	10	9.5
Duodenum	2.0	—	3.4
Pancreas	0.7	71.9	20
Gallbladder	0.3	17.8	5
Bronchus, lung, trachea	27.9	5.7	13
Midgut			
Jejunum	1.8	{58.4	9
Ileum	14.9		9
Meckel's diverticulum	0.5	—	13
Appendix	4.8	38.8	<1
Colon	8.6	51	5
Liver	0.4	32.2	—
Ovary	1.0	32	50
Testis	<0.1	—	50
Hindgut			
Rectum	13.6	3.9	—

**Source:** Location is from the PAN-SEER data (1973–1999), and incidence of metastases from the SEER data (1992–1999), reported by IM Modlin et al: Cancer 97:934, 2003. Incidence of carcinoid syndrome is from 4349 cases studied from 1950–1971, reported by JD Godwin, Cancer 36:560, 1975.

diagnosis of the specific syndrome requires the clinical features of the disease and cannot be made from the immunocytochemistry results alone. Furthermore, pathologists cannot distinguish between benign and malignant NETs unless metastases or invasion are present.

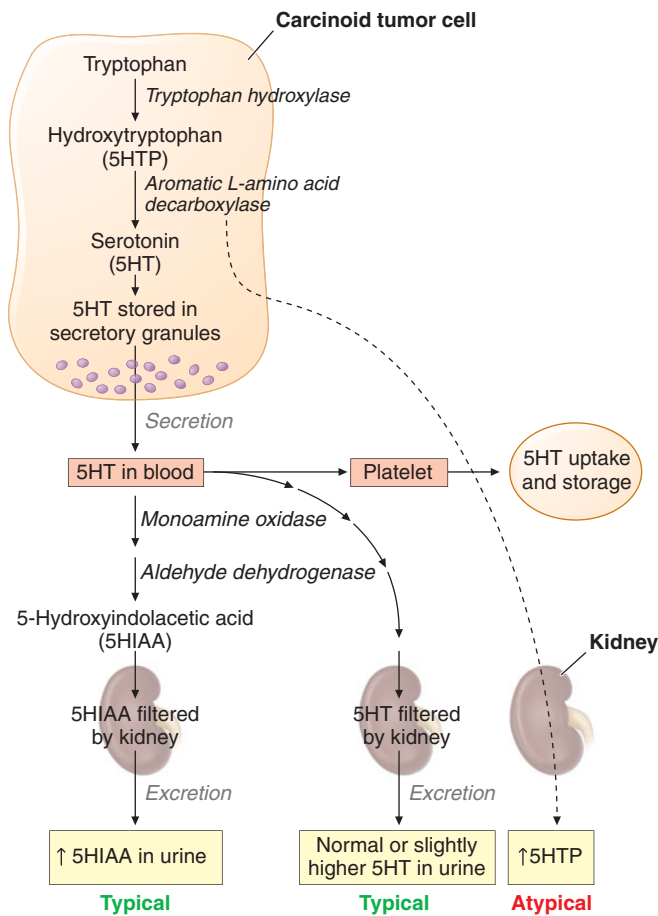
Carcinoid tumors are frequently classified according to their anatomic area of origin (i.e., foregut, midgut, hindgut) because tumors with similar embryonic origin share functional manifestations, histochemistry, and secretory products (Table 46-3). Foregut tumors generally have a low serotonin (5HT) content, are argentaﬀin-negative but argyrophilic, occasionally secrete adrenocorticotrophic hormone (ACTH) or 5-hydroxytryptophan (5HTP) causing an atypical carcinoid syndrome (Fig. 46-1), are often multihormonal, and may metastasize to bone. They uncommonly produce a clinical syndrome due to the secreted products. Midgut carcinoids are argentaﬀin-positive, have a high 5HT content, most frequently cause the typical carcinoid syndrome when they metastasize (Table 46-3, Fig. 46-1), release 5HT and tachykinins (substance P, neuropeptide K, substance K), rarely secrete 5HTP or ACTH, and uncommonly metastasize to bone. Hindgut carcinoids (rectum, transverse and descending colon) are argentaﬀin-negative, often argyrophilic, rarely contain 5HT or cause the carcinoid syndrome (Fig. 46-1, Table 46-3), rarely secrete 5HTP or ACTH, contain numerous peptides, and may metastasize to bone.

PETs can be classified into nine well-established specific functional syndromes (Table 46-2), four possible specific functional syndromes (PETs secreting calcitonin,

renin, luteinizing hormone, or erythropoietin), and nonfunctional PETs [pancreatic polypeptide (PP)-secreting tumors; PPomas]. Each of the functional syndromes is associated with symptoms due to the specific hormone released. In contrast, nonfunctional PETs release no products that cause a specific clinical syndrome. “Non-functional” is a misnomer in the strict sense because they frequently ectopically secrete a number of peptides (PP, chromogranin A, ghrelin, neurotensin,  $\alpha$  subunits of human chorionic gonadotropin (hCG), neuron-specific enolase); however, they cause no specific clinical syndrome. The symptoms caused by nonfunctional PETs are entirely due to the tumor per se.

Carcinoid tumors can occur in almost any GI tissue (Table 46-3); however, at present most (70%) take origin from one of three sites: bronchus, jejunoileum, or colon/rectum. In the past, carcinoid tumors most frequently were reported in the appendix (i.e., 40%); however, the bronchus/lung and small intestine are now the most common sites. Overall, GI carcinoids are the most common site for these tumors, comprising 64%, with the respiratory tract second at 28%.

The term *pancreatic endocrine tumor*, although widely used and therefore retained here, is also a misnomer, strictly speaking, because these tumors can occur either almost entirely in the pancreas (insulinomas, glucagonomas, nonfunctional PETs, PETs causing hypercalcemia) or at both pancreatic and extrapancreatic sites [gastrinomas, VIPomas (VIP, vasoactive intestinal peptide), somatostatinomas, GRFomas (GRF, growth hormone-releasing factor)]. PETs are also called *islet cell tumors*; however, this



**FIGURE 46-1**  
**Synthesis, secretion, and metabolism of serotonin (5HT)**  
 in patients with typical and atypical carcinoid syndromes.  
 5HIAA, 5-hydroxyindolacetic acid.

term is discouraged because it is not established that they originate from the islets, and many can occur at extrapancreatic sites.

A uniform World Health Organization (WHO) classification for all GI NETs (including carcinoids and PETs) divides them into three general categories: (1a) well-differentiated NETs, (1b) well-differentiated neuroendocrine carcinomas of low-grade malignancy, and (2) poorly differentiated neuroendocrine carcinomas that are usually small cell neuroendocrine carcinomas of high-grade malignancy. The term *carcinoid* is synonymous with *well-differentiated NETs* (1a). This classification is further divided on the basis of tumor location and biology. Furthermore, for the first time a standard TNM classification has been proposed for the GI foregut NETs. The availability of this WHO classification and the TNM classification should greatly facilitate the comparison of clinical, pathologic, and prognostic features and results of treatment in GI NETs from different studies.

The exact incidence of carcinoid tumors or PETs varies according to whether only symptomatic or all tumors are considered. The incidence of clinically significant carcinoids is 7–13 cases/million population per year,

whereas any malignant carcinoids at autopsy are reported in 21–84 cases/million population per year. Clinically significant PETs have a prevalence of 10 cases per million population with insulinomas, gastrinomas, and nonfunctional PETs having an incidence of 0.5–2 cases per million population per year (Table 46-2). VIPomas are 2- to 8-fold less common, glucagonomas are 17- to 30-fold less common, and somatostatinomas the least common. In autopsy studies, 0.5–1.5% of all cases have a PET; however, in <1 in 1000 cases was a functional tumor thought to occur.

Both carcinoid tumors and PETs commonly show malignant behavior (Tables 46-2, -3). With PETs, except for insulinomas in which <10% are malignant, 50–100% in different series are malignant. With carcinoid tumors, the percentage showing malignant behavior varies in different locations. For the three most common sites of occurrence, the incidence of metastases varies greatly from jejunioileum (58%) >lung/bronchus (6%) >rectum (4%). With both carcinoid tumors and PETs, a number of factors influence survival and the aggressiveness of the tumor (Table 46-4). The presence of liver metastases is the single most important prognostic factor in single and multivariate analyses for both carcinoid tumors and PETs. Particularly important in the development of liver metastases is the size of the primary tumor. For example, with small-intestinal carcinoids, the most frequent cause of the carcinoid syndrome due to metastatic disease in the liver (Table 46-2), metastases occur in 15–25% if the tumor diameter is <1 cm, 58–80% if it is 1–2 cm, and >75% if >2 cm. Similar data exist for gastrinomas and other PETs, where the size of the primary tumor has been shown to be an independent predictor of the development of liver metastases. The presence of lymph node metastases, the depth of invasion, various histologic features [differentiation, mitotic rates, growth indices, vessel density, vascular endothelial growth factor (VEGF), and CD10 metalloproteinase expression], elevated serum alkaline phosphatase levels, and flow cytometric results (such as the presence of aneuploidy) are all important prognostic factors for the development of metastatic disease (Table 46-4). For patients with carcinoid tumors, additional poor prognostic factors include the development of the carcinoid syndrome, older age, male sex, the presence of a symptomatic tumor, or higher levels of a number of tumor markers [5-hydroxyindolacetic acid (5HIAA), neuropeptide K, chromogranin A]. With PETs or gastrinomas, the best studied PET, a worse prognosis is associated with female sex, overexpression of the *ha-ras* oncogene or p53, the absence of multiple endocrine neoplasia-type 1 (MEN1), and higher levels of various tumor markers (i.e., chromogranin A, gastrin).

A number of genetic disorders are associated with an increased incidence of NETs (Table 46-5). Each one is caused by a loss of a possible tumor-suppressor gene. The most important is MEN1, an autosomal dominant

TABLE 46-4

## PROGNOSTIC FACTORS IN NEUROENDOCRINE TUMORS

Both carcinoid tumors and PETs

- Presence of liver metastases ( $p < .001$ )
- Extent of liver metastases ( $p < .001$ )
- Presence of lymph node metastases ( $p < .001$ )
- Depth of invasion ( $p < .001$ )
- Elevated serum alkaline phosphatase levels ( $p = 0.003$ )
- Primary tumor site ( $p < .001$ )
- Primary tumor size ( $p < .005$ )
- Various histologic features
  - Tumor differentiation ( $p < .001$ )
  - High growth indices (high Ki-67 index, PCNA expression)
  - High mitotic counts ( $p < .001$ )
  - Vascular or perineural invasion
  - Vessel density (low microvessel density, increased lymphatic density)
  - Low VEGF, high CD10 metalloproteinase expression)
  - Flow cytometric features (i.e., aneuploidy)

Carcinoid tumors

- Presence of carcinoid syndrome
- Laboratory results [urinary 5-HIAA level ( $p < .01$ ), plasma neuropeptide K ( $p < 0.05$ ), serum chromogranin A ( $p < .01$ )]
- Presence of a second malignancy
- Male sex ( $p < 0.001$ )
- Older age ( $p < 0.01$ )
- Mode of discovery (incidental >symptomatic)
- Molecular findings [TGF- $\alpha$  expression ( $p < 0.05$ ), chr 16q LOH or gain chr 4p ( $p < 0.05$ )]

PETs

- Ha-Ras* oncogene or p53 overexpression
- Female sex
- MEN1 syndrome absent
- Laboratory findings (increased chromogranin A in some studies; gastrinomas—increased gastrin level)
- Molecular findings [increased *HER2/neu* expression ( $p = .032$ ), chr 1q, 3p, 3q, or 6q LOH ( $p = 0.0004$ ), EGF receptor overexpression ( $p = 0.034$ ), gains in chr 7q, 17q, 17p, 20q]

**Note:** PET, pancreatic endocrine tumor; Ki-67, proliferation-associated nuclear antigen recognized by Ki-67 monoclonal antibody; PCNA, proliferating cell nuclear antigen; 5HIAA, 5-hydroxyindoleacetic acid; TGF- $\alpha$ , transforming growth factor  $\alpha$ ; chr, chromosome; LOH, loss of heterozygosity; MEN, multiple endocrine neoplasia; EGF, epidermal growth factor.

TABLE 46-5

## GENETIC SYNDROMES ASSOCIATED WITH AN INCREASED INCIDENCE OF NEUROENDOCRINE TUMORS [NETs (CARCINOIDS OR PANCREATIC ENDOCRINE TUMORS) (PETs)]

SYNDROME	LOCATION OF GENE MUTATION AND GENE PRODUCT	NETs SEEN/FREQUENCY
Multiple endocrine neoplasia type 1 (MEN1)	11q13 (encodes 610-amino-acid protein, menin)	80–100% develop PETs: (nonfunctional > gastrinoma > insulinoma) Carcinoids: gastric (13–30%), bronchial/thymic (8%)
von Hippel–Lindau disease	3q25 (encodes 213-amino-acid protein)	12–17% develop PETs (almost always nonfunctional)
von Recklinghausen's disease [neurofibromatosis 1 (NF-1)]	17q11.2 (encodes 2485-amino-acid protein, neurofibromin)	Duodenal somatostatinomas (usually nonfunctional) Rarely insulinoma, gastrinoma
Tuberous sclerosis	9q34 (TSC1) encodes 1164-amino-acid protein, hamartin 16p13 (TSC2) (encodes 1807-amino-acid protein, tuberin)	Uncommonly develop PETs [nonfunctional and functional (insulinoma, gastrinoma)]



584 disorder due to a defect in a 10-exon gene on 11q13, which encodes for a 610-amino acid nuclear protein, menin (Chap. 47). Patients with MEN1 develop hyperparathyroidism due to parathyroid hyperplasia in 95–100%, PETs in 80–100%, pituitary adenomas in 54–80%, bronchial carcinoids in 8%, thymic carcinoids in 8%, and gastric carcinoids in 13–30% of the patients with Zollinger–Ellison syndrome (ZES). In patients with MEN1, 80–100% develop nonfunctional PETs; functional PETs occur in 80%, with 54% developing ZES, 21% insulinomas, 3% glucagonomas, and 1% VIPomas. MEN1 is present in 20–25% of all patients with ZES, in 4% with insulinomas, and in a low percentage (<5%) of the other PETs.

Three phacomatoses associated with NETs are von Hippel–Lindau disease (VHL), von Recklinghausen’s disease [neurofibromatosis (NF) type 1], and tuberous sclerosis (Bourneville’s disease). VHL is an autosomal dominant disorder due to defects in a gene on chromosome 3p25, which encodes a 213-amino-acid protein that interacts with the elongin family of proteins as a transcriptional regulator (Chaps. 43, 47, 48). In addition to cerebellar hemangioblastomas, renal cancer, and pheochromocytomas, 10–17% of these patients develop a PET. Most are nonfunctional, although insulinomas and VIPomas are reported. Patients with NF-1 have defects in a gene on chromosome 17q11.2 encoding for a 2845-amino-acid protein, neurofibromin, which functions in normal cells as a suppressor of the *ras* signaling cascade (Chap. 43). Up to 12% of these patients develop an upper GI carcinoid tumor, characteristically in the periampullary region (54%). Many are classified as somatostatinomas because they contain somatostatin immunocytochemically; however, they uncommonly secrete somatostatin or produce a clinical somatostatinoma syndrome. NF-1 has rarely been associated with insulinomas and ZES. Tuberous sclerosis is caused by mutations that alter either the 1164-amino-acid protein, hamartin (TSC1), or the 1807-amino-acid protein, tuberin (TSC2) (Chap. 43). Both hamartin and tuberin interact in a pathway related to cytosolic G protein regulation. A few cases including nonfunctional and functional PETs (insulinomas and gastrinomas) have been reported in these patients (Table 46-5).

In contrast to most common nonendocrine tumors such as carcinoma of the breast, colon, lung, or stomach, alterations in common oncogenes (*ras*, *myc*, *fos*, *src*, *jun*) or tumor-suppressor genes (p53, retinoblastoma susceptibility gene) have not been found in PETs or carcinoid tumors. Alterations that may be important in their pathogenesis include changes in the *MEN1* gene, p16/MTS1 tumor-suppressor gene, and DPC 4/*Smad 4* gene; amplification of the *HER-2/neu* protooncogene and growth factors and their receptors; methylation of a

number of genes likely resulting in their inactivation; and deletions of unknown tumor-suppressor genes as well as gains in other unknown genes (Table 46-1). Comparative genomic hybridization and genome-wide allelotyping studies have shown differences in chromosomal losses and gains between PETs and carcinoids, some of which have prognostic significance (Table 46-4). Mutations in the *MEN1* gene are likely particularly important. Loss of heterozygosity at the *MEN1* locus on chromosome 11q13 is seen in 93% of sporadic PETs (i.e., in patients without MEN1) and in 26–75% of sporadic carcinoid tumors. Mutations in the *MEN1* gene are reported in 31–34% of sporadic gastrinomas. The presence of a number of these molecular alterations (PET or carcinoid) correlates with tumor growth, tumor size, disease extent or invasiveness and may have prognostic significance.

## CARCINOID TUMORS AND CARCINOID SYNDROME

### CHARACTERISTICS OF THE MOST COMMON GI CARCINOID TUMORS

#### Appendiceal Carcinoids

These occur in 1 in every 200–300 appendectomies, usually in the appendiceal tip. In older studies, most (i.e., >90%) are reported as <1 cm in diameter without metastases, but more recent reports find that 2–35% have metastases (Table 46-3). In the SEER data of 1570 appendiceal carcinoids, 62% were localized and 27% had regional and 8% had distant metastases; half of those between 1 and 2 cm metastasized to lymph nodes. Their percentage of the total number of carcinoids has decreased from 43.9% (1950–1969) to 2.4% (1992–1999).

#### Small Intestinal Carcinoids

These are frequently multiple; 70–80% are present in the ileum and 70% within 6 cm (24 in.) of the ileocecal valve. Some 40% are <1 cm in diameter, 32% are 1–2 cm, and 29% are >2 cm. Between 35 and 70% are associated with metastases (Table 46-3). They characteristically cause a marked fibrotic reaction, which can lead to intestinal obstruction. Distant metastases occur to the liver in 36–60%, to bone in 3%, and to lung in 4%. Tumor size affects the frequency of metastases. However, even small carcinoid tumors of the small intestine (<1 cm) have metastases in 15–25%, whereas it increases to 58–100% for tumors 1–2 cm in diameter. Carcinoids also occur in the duodenum, with 31% having metastases. No duodenal tumor <1 cm in two series metastasized, whereas 33% of those >2 cm had

metastases. Small-intestinal carcinoids are the most common cause (60–87%) of the carcinoid syndrome and are discussed later.

### **Rectal Carcinoids**

Rectal carcinoids are found in ~1 of every 2500 proctoscopies. Nearly all occur between 4 and 13 cm above the dentate line. Most are small, with 66–80% <1 cm in diameter, and they rarely metastasize (5%). Tumors between 1 and 2 cm can metastasize in 5–30% and tumors >2 cm, which are uncommon, in >70%.

### **Bronchial Carcinoids**

The frequency of bronchial carcinoids is not related to smoking. A number of different classifications of bronchial carcinoid tumors are proposed. In some studies, lung NETs are classified into four categories: typical carcinoid [also called bronchial carcinoid tumor, Kulchitsky cell carcinoma (KCC)-I]; atypical carcinoid (also called well-differentiated neuroendocrine carcinoma, KCC-II); intermediate small cell neuroendocrine carcinoma; and small cell neuroendocarcinoma (KCC-III). Another proposed classification includes three categories of lung NETs: benign or low-grade malignant (typical carcinoid), low-grade malignant (atypical carcinoid), and high-grade malignant (poorly differentiated carcinoma of the large cell or small cell type). These different categories of lung NETs have different prognoses, varying from excellent for typical carcinoid to poor for small cell neuroendocrine carcinomas.

### **Gastric Carcinoids**

These account for 3 of every 1000 gastric neoplasms. It is thought that three different subtypes of gastric carcinoids occur. Each originates from gastric enterochromaffin-like (ECL) cells in the gastric mucosa. Two subtypes are associated with hypergastrinemic states, either chronic atrophic gastritis (type I) (80% of all gastric carcinoids) or ZES, almost always as part of the MEN1 syndrome (type II) (6% of all cases). These tumors generally pursue a benign course, with 9–30% associated with metastases. They are usually multiple, small, and infiltrate only to the submucosa. The third subtype of gastric carcinoid (type III) (sporadic) occurs without hypergastrinemia (14% of all carcinoids) and pursues an aggressive course, with 54–66% developing metastases. Sporadic carcinoids are usually single large tumors, 50% have atypical histology, and they can be a cause of the carcinoid syndrome. Gastric carcinoids as a percentage of all carcinoids are increasing in frequency [1.96% (1969–71), 3.6% (1973–91), 5.8% (1991–99)].

## **CARCINOID TUMORS WITHOUT THE CARCINOID SYNDROME**

The age of patients at diagnosis ranges from 10–93 years with a mean of 63 years for small intestine and 66 years for the rectum. The presentation is diverse and related to the site of origin and extent of malignant spread. In the appendix, carcinoid tumors are usually found incidentally during surgery for suspected appendicitis. Small-intestinal carcinoids in the jejunioileum present with periodic abdominal pain (51%), intestinal obstruction with ileus/invagination (31%), an abdominal tumor (17%), or GI bleeding (11%). Because of the vagueness of the symptoms, the diagnosis is usually delayed ~2 years from onset of the symptoms, ranging up to 20 years. Duodenal, gastric, and rectal carcinoids are most frequently found by chance at endoscopy. The most common symptoms of rectal carcinoids are melena/bleeding (39%), constipation (17%), and diarrhea (12%). Bronchial carcinoids are frequently discovered as a lesion on a chest radiograph, and 31% of the patients are asymptomatic. Thymic carcinoids present as anterior mediastinal masses on chest radiograph or CT scan. Ovarian and testicular carcinoids usually present as masses discovered on physical examination or ultrasound. Metastatic carcinoid tumor in the liver frequently presents as hepatomegaly in a patient who may have minimal symptoms and near-normal liver function tests.

## **CARCINOID TUMORS WITH SYSTEMIC SYMPTOMS DUE TO SECRETED PRODUCTS**

Carcinoid tumors can contain numerous GI peptides: gastrin, insulin, somatostatin, motilin, neurotensin, tachykinins (substance K, substance P, neuropeptide K), glucagon, gastrin-releasing peptide, VIP, PP, other biologically active peptides (ACTH, calcitonin, growth hormone), prostaglandins and bioactive amines (5HT). These substances may or may not be released in sufficient amounts to cause symptoms. In various studies of patients with carcinoid tumors, elevated serum levels of PP were found in 43%, motilin in 14%, gastrin in 15%, and VIP in 6%. Foregut carcinoids are more likely to produce various GI peptides than midgut carcinoids. Ectopic ACTH production causing Cushing's syndrome is increasingly seen with foregut carcinoids (respiratory tract primarily) and in some series was the most common cause of the ectopic ACTH syndrome, accounting for 64% of all cases. Acromegaly due to GRF release occurs with foregut carcinoids, as does the somatostatinoma syndrome, but rarely occurs with duodenal carcinoids. The most common systemic syndrome with carcinoid tumors is the carcinoid syndrome.

**Clinical Features**

The cardinal features at presentation as well as during the disease course are shown in **Table 46-6**. Flushing and diarrhea are the two most common symptoms, occurring in up to 73% initially and in up to 89% during the course of the disease. The characteristic flush is of sudden onset; it is a deep red or violaceous erythema of the upper body, especially the neck and face, often associated with a feeling of warmth, and occasionally associated with pruritus, lacrimation, diarrhea, or facial edema. Flushes may be precipitated by stress, alcohol, exercise, certain foods such as cheese, or by certain agents such as catecholamines, pentagastrin, and serotonin reuptake inhibitors. Flushing episodes may be brief, lasting 2–5 min, especially initially, or may last hours, especially later in the disease course. Flushing is usually seen with midgut carcinoids but can also occur with foregut carcinoids. With bronchial carcinoids the flushes are frequently prolonged for hours to days, reddish in color, and associated with salivation, lacrimation, diaphoresis, diarrhea, and hypotension. The flush associated with gastric carcinoids is also reddish but patchy in distribution over the face and neck. It may be provoked by food and have accompanying pruritus.

Diarrhea is present in 32–73% initially and 68–84% at some time in their disease course. Diarrhea usually occurs with flushing (85% of cases). The diarrhea is usually described as watery with 60% having <1 L/day of

diarrhea. Steatorrhea is present in 67%, and in 46% it is >15 g/d (normal <7 g). Abdominal pain may be present with the diarrhea or independently in 10–34% of cases.

Cardiac manifestations occur in 11% initially and in 14–41% at some time in the disease course. The cardiac disease is due to fibrosis involving the endocardium, primarily on the right side, although left side lesions can occur also. The dense fibrous deposits are most commonly on the ventricular aspect of the tricuspid valve and less commonly on the pulmonary valve cusps. They can result in constriction of the valves, and pulmonic stenosis is usually predominant, whereas the tricuspid valve is often fixed open, resulting in regurgitation predominating. Up to 80% of patients with cardiac lesions develop heart failure. Lesions on the left side are much less extensive, occur in 30% at autopsy, and most frequently affect the mitral valve.

Other clinical manifestations include wheezing or asthma-like symptoms (8–18%) and pellagra-like skin lesions (2–25%). A variety of noncardiac problems due to increased fibrous tissue have been reported including retroperitoneal fibrosis causing urethral obstruction, Peyronie's disease of the penis, intraabdominal fibrosis, and occlusion of the mesenteric arteries or veins.

**Pathobiology**

In different studies, carcinoid syndrome occurred in 8% of 8876 patients with carcinoid tumors with a rate of 1.4–18.4%. It only occurs when sufficient concentrations of secreted products by the tumor reach the systemic circulation. In 91% of cases this occurs after distant metastases to the liver. Rarely primary gut carcinoids with nodal metastases with extensive retroperitoneal invasion, pancreatic carcinoids with retroperitoneal lymph nodes, or carcinoids of the lung or ovary with direct access to the systemic circulation can cause the carcinoid syndrome without hepatic metastases. All carcinoid tumors do not have the same propensity to metastasize and cause the carcinoid syndrome. Midgut carcinoids account for 60–67% of the cases of carcinoid syndrome, foregut tumors for 2–33%, hindgut for 1–8%, and an unknown primary location for 2–15% (Tables 46-2, 46-3).

One of the main secretory products of carcinoid tumors involved in the carcinoid syndrome is 5HT (Fig. 46-1), which is synthesized from tryptophan. Up to 50% of dietary tryptophan can be used in this synthetic pathway by tumor cells, which can result in inadequate supplies for conversion to niacin; hence some patients (2.5%) develop pellagra-like lesions. 5HT has numerous biologic effects including stimulating intestinal secretion with inhibition of absorption, stimulating increases in intestinal motility, and stimulating fibrogenesis. In various studies 56–88% of all carcinoid tumors were associated with 5HT overproduction; however, 12–26% of

**TABLE 46-6****CLINICAL CHARACTERISTICS IN PATIENTS WITH CARCINOID SYNDROME**

	<b>AT PRESENTATION</b>	<b>DURING COURSE OF DISEASE</b>
Symptoms/signs		
Diarrhea	32–73%	68–84%
Flushing	23–65%	63–74%
Pain	10%	34%
Asthma/wheezing	4–8%	3–18%
Pellagra	2%	5%
None	12%	22%
Carcinoid heart disease present	11%	14–41%
Demographics		
Male	46–59%	46–61%
Age		
Mean	57 yrs	52–54 yrs
Range	25–79 yrs	9–91 yrs
Tumor location		
Foregut	5–9%	2–33%
Midgut	78–87%	60–87%
Hindgut	1–5%	1–8%
Unknown	2–11%	2–15%

patients did not have the carcinoid syndrome. In one study, platelet 5HT was elevated in 96% of patients with midgut carcinoids, in 43% with foregut tumors, and in 0% with hindgut tumors. In 90–100% of patients with the carcinoid syndrome, evidence of 5HT overproduction is noted. 5HT is thought to be predominantly responsible for the diarrhea by its effects on gut motility and intestinal secretion, primarily through 5HT<sub>3</sub> and, to a lesser degree, 5HT<sub>4</sub> receptors. Serotonin receptor antagonists (especially 5HT<sub>3</sub> antagonists) relieve the diarrhea in most patients. Additional studies suggest prostaglandin E<sub>2</sub> and tachykinins may be important mediators of the diarrhea in some patients. 5HT does not appear to be involved in the flushing because flushing is not relieved by serotonin receptor antagonists. In patients with gastric carcinoids the red, patchy pruritic flush is likely due to histamine release because it can be prevented by H<sub>1</sub> and H<sub>2</sub> receptor antagonists. Numerous studies show tachykinins are stored in carcinoid tumors and released during flushing. However, octreotide can relieve the flushing induced by pentagastrin in these patients without altering the stimulated increase in plasma substance P, suggesting that other mediators must be involved in the flushing. Both histamine and 5HT may be responsible for the wheezing as well as the fibrotic reactions involving the heart, causing Peyronie's disease and intraabdominal fibrosis. The exact mechanism of the heart disease is unclear. The valvular heart disease caused by the appetite-suppressant drug dexfenfluramine is histologically indistinguishable from that observed in carcinoid disease. Furthermore, ergot-containing dopamine receptor agonists used for Parkinson's disease (pergolide, cabergoline) cause valvular heart disease that closely resembles that seen in the carcinoid syndrome. Metabolites of fenfluramine, as well as the dopamine receptor agonists, have high affinity for 5HT<sub>2B</sub> receptors, activation of which is known to cause fibroblast mitogenesis. High levels of 5HT<sub>2B</sub> receptors are known to occur in heart valves. Studies on cultured interstitial cells from human cardiac valves demonstrate that these valvulopathic drugs induce mitogenesis by activating 5HT<sub>2B</sub> receptors and stimulating upregulation of transforming growth factor  $\beta$  and collagen biosynthesis. These observations support the conclusion that 5HT overproduction by carcinoid tumors is important in mediating the valvular changes, possibly by activating 5HT<sub>2B</sub> receptors in the endocardium. Both the magnitude of serotonin overproduction and prior chemotherapy are important predictors of progression of the heart disease. Atrial natriuretic peptide overproduction is also reported in patients with cardiac disease, but its role in the pathogenesis is unknown.

Patients may develop either a typical or atypical carcinoid syndrome. In patients with the typical form, characteristically caused by a midgut carcinoid tumor, the conversion of tryptophan to 5HTP is the rate-limiting

step (Fig. 46-1). Once 5HTP is formed, it is rapidly converted to 5HT and stored in secretory granules of the tumor or in platelets. A small amount remains in plasma that is converted to 5HIAA, which appears in large amounts in the urine. These patients have an expanded 5HT pool size, increased blood and platelet 5HT, and increased urinary 5HIAA. Some carcinoid tumors cause an atypical carcinoid syndrome thought due to a deficiency in the enzyme dopa decarboxylase, and thus 5HTP cannot be converted to 5HT and instead is secreted into the bloodstream. In these patients, plasma 5HT levels are normal but urinary levels may be increased because some 5HTP is converted to 5HT in the kidney. Characteristically, urinary 5HTP and 5HT are increased, but urinary 5HIAA levels are only slightly elevated. Foregut carcinoids are the most likely to cause an atypical carcinoid syndrome.

One of the most immediate life-threatening complications of the carcinoid syndrome is the development of a carcinoid crisis. This is more frequent in patients who have intense symptoms or have greatly increased urinary 5HIAA levels (i.e., >200 mg/d). The crises may occur spontaneously or be provoked by stress, anesthesia, chemotherapy, or a biopsy. Patients develop intense flushing, diarrhea, abdominal pain, and cardiac abnormalities including tachycardia, hypertension, or hypotension. If not adequately treated, it can be a terminal event.

## DIAGNOSIS OF THE CARCINOID SYNDROME AND CARCINOID TUMORS

The diagnosis of carcinoid syndrome relies on measurement of urinary or plasma serotonin or its metabolites in the urine. The measurement of 5HIAA is most frequently used. False-positive elevations may occur if the patient is eating serotonin-rich foods such as bananas, pineapple, walnuts, pecans, avocados, or hickory nuts or is taking certain medications (cough syrup containing guaifenesin, acetaminophen, salicylates, or L-dopa). The normal range in daily urinary 5HIAA excretion is 2 to 8 mg/d. In one study, 92% of patients with carcinoid syndrome had 5HT overproduction; in another, 5HIAA had a 73% sensitivity and 100% specificity for carcinoid syndrome.

Most physicians use only the urinary 5HIAA excretion rate; however, plasma and platelet serotonin levels, if available, may give additional information. Platelet serotonin levels are more sensitive than urinary 5HIAA but are not generally available. Because patients with foregut carcinoids may produce an atypical carcinoid syndrome, if this syndrome is suspected and urinary 5HIAA is minimally elevated or normal, other urinary metabolites of tryptophan, such as 5HTP or 5HT, should be measured.

Flushing occurs in a number of other conditions, such as systemic mastocytosis, chronic myeloid leukemia

588 with increased histamine release, and menopause; as a reaction to alcohol or glutamate; and as a side effect of chlorpropamide, calcium channel blockers, and nicotinic acid. None of these conditions cause an increased urinary 5HIAA.

The diagnosis of carcinoid tumor can be suggested by the carcinoid syndrome, by recurrent abdominal symptoms in a healthy-appearing individual, or by discovering hepatomegaly or hepatic metastases associated with minimal symptoms. Ileal carcinoids, which are 25% of all clinically detected carcinoids, should be suspected in patients with bowel obstruction, abdominal pain, flushing, or diarrhea.

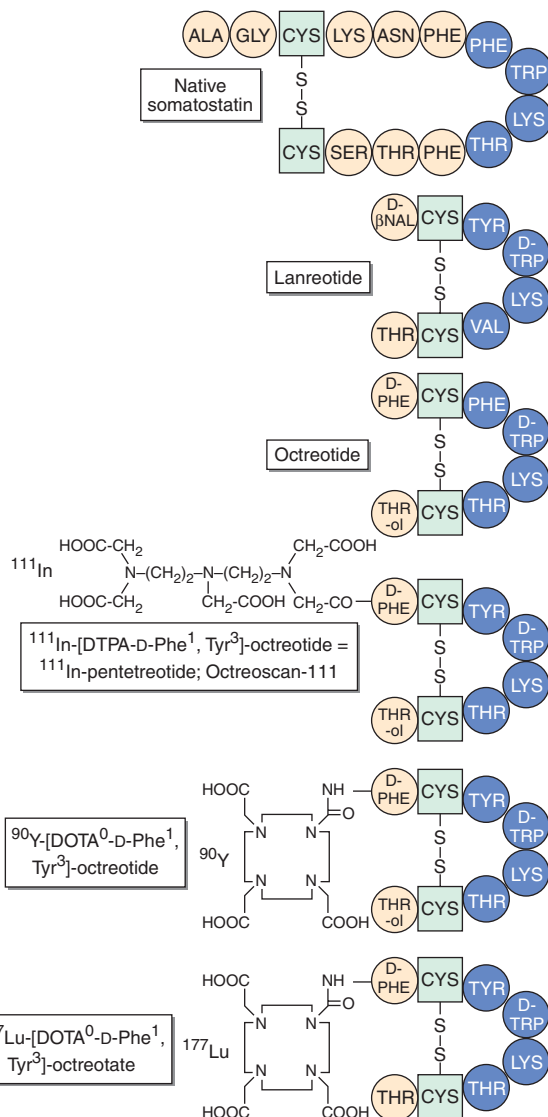
Serum chromogranin A levels are elevated in 56–100% of patients with carcinoid tumors, and the level correlates with tumor bulk. Serum chromogranin A levels are not specific for carcinoid tumors because they are also elevated in patients with PETs and other NETs. Plasma neuron-specific enolase levels are also used as a marker of carcinoid tumors but are less sensitive than chromogranin A, being increased in only 17–47% of patients.

**Treatment:**  
**R<sub>x</sub> CARCINOID SYNDROME AND NONMETASTATIC CARCINOID TUMORS**

**CARCINOID SYNDROME** Treatment includes avoiding conditions that precipitate flushing, dietary supplementation with nicotinamide, treatment of heart failure with diuretics, treatment of wheezing with oral bronchodilators, and controlling the diarrhea with antidiarrheal agents such as loperamide or diphenoxylate. If patients still have symptoms, serotonin receptor antagonists or somatostatin analogues are the drugs of choice.

There are 14 subclasses of 5HT receptors, and antagonists for most are not available. The 5HT<sub>1</sub> and 5HT<sub>2</sub> receptor antagonists methysergide, cyproheptadine, and ketanserin have all been used to control the diarrhea but usually do not decrease flushing. Methysergide use is limited because it can cause retroperitoneal fibrosis. Ketanserin diminishes diarrhea in 30–100% of patients. 5HT<sub>3</sub> receptor antagonists (ondansetron, tropisetron, alosetron) can control diarrhea and nausea in up to 100% of patients and occasionally ameliorate the flushing. A combination of histamine H<sub>1</sub> and H<sub>2</sub> receptor antagonists (i.e., diphenhydramine and cimetidine or ranitidine) may control flushing in patients with foregut carcinoids.

Synthetic analogues of somatostatin (octreotide, lanreotide) are the most widely used agents to control the symptoms of patients with carcinoid syndrome (Fig. 46-2). These drugs are effective at relieving symptoms and decreasing urinary 5HIAA levels in patients with carcinoid syndrome. Octreotide controls symptoms in >80%



**FIGURE 46-2** Structure of somatostatin and synthetic analogues used for diagnostic or therapeutic indications.

of patients, including the diarrhea and flushing, and 70% of patients have a >50% decrease in urinary 5HIAA excretion. Patients with mild to moderate symptoms should initially be treated with 100 μg SC every 8 h. Individual responses vary, and some patients have received as much as 3000 μg/d. Some 40% of patients escape control after a median of 4 months, and the dose may need to be increased. Similar results are reported with lanreotide.

In patients with carcinoid crises, somatostatin analogues are effective at both treating the condition as well as preventing symptoms during known precipitating events such as surgery, anesthesia, chemotherapy, or stress. It is recommended that octreotide, 150–250 μg SC every 6–8 h, be used 24–48 h before anesthesia and then continued throughout the procedure.

Sustained-release preparations of both octreotide [octreotide-LAR (long-acting release)] and lanreotide [lanreotide-PR (prolonged release, lanreotide autogel)] permit infrequent injections. Octreotide-LAR (30 mg/month) gives a plasma level  $\geq 1$  ng/mL for 25 days, whereas this requires 3–6 injections per day of the non-sustained-release form. Lanreotide-PR is given IM every 10–14 days, and the lanreotide autogel every 4–6 weeks. Each of the sustained-release forms is highly effective at controlling the symptoms of the carcinoid syndrome (61–85% of patients).

Short-term side effects occur in 40–60% of patients receiving SC somatostatin analogues. Pain at the injection site and side effects related to the GI tract (59% discomfort, 15% nausea, diarrhea) are the most common. They are usually short-lived and do not interrupt treatment. Important long-term side effects include gallstone formation, steatorrhea, and deterioration in glucose tolerance. The overall incidence of gallstones/biliary sludge in one study was 52%, with 7% having symptomatic disease requiring surgical treatment.

Interferon  $\alpha$  (IFN- $\alpha$ ) is effective in controlling symptoms of the carcinoid syndrome, either alone or combined with hepatic artery embolization. With IFN- $\alpha$  alone the response rate is 42%, and with IFN- $\alpha$  with hepatic artery embolization, diarrhea was controlled for 1 year in 43% and flushing in 86%.

Hepatic artery embolization alone or with chemotherapy (chemoembolization) has been used to control the symptoms of carcinoid syndrome. Embolization alone is reported to control symptoms in up to 76% of patients and chemoembolization (5-fluorouracil, doxorubicin, cisplatin, mitomycin) in 60–75% of patients. Hepatic artery embolization can have major side effects including nausea, vomiting, pain, and fever. In two studies, 5–7% of patients died from complications of hepatic artery occlusion.

Other drugs have been used successfully in small numbers of patients to control the symptoms of carcinoid syndrome. Parachlorophenylalanine can inhibit tryptophan hydroxylase and the conversion of tryptophan to 5HTP. However, its severe side effects, including psychiatric disturbances, make it intolerable for long-term use.  $\alpha$ -Methyl-dopa inhibits the conversion of 5HTP to 5HT; however, its effects are only partial.

#### CARCINOID TUMORS (NONMETASTATIC)

Surgery is the only potentially curative therapy. The extent of surgical resection is determined by the size of the primary. With appendiceal carcinoids, appendectomy was curative in 103 patients followed for up to 35 years. With rectal carcinoids  $< 1$  cm, local resection is curative. With small-intestinal carcinoids  $< 1$  cm, consensus had not been reached. Because 15–69% of small-intestinal carcinoids this size have metastases, some recommend a wide

resection with en bloc resection of the adjacent lymph-bearing mesentery. If the carcinoid tumor is  $> 2$  cm in rectal, appendiceal, or small-intestinal sites, a full cancer operation should be done. This includes a right hemicolectomy for appendiceal carcinoid, an abdominoperineal resection or low anterior resection for rectal carcinoids, and an en bloc resection of adjacent lymph nodes for small-intestinal carcinoids. For carcinoids 1–2 cm in diameter, a simple appendectomy is proposed by some for appendiceal tumors, whereas others favor a formal right hemicolectomy. For 1- to 2-cm rectal carcinoids, a wide local full-thickness excision is performed.

With type I or II gastric carcinoids, which are usually  $< 1$  cm, endoscopic removal is recommended. In type I or II gastric carcinoids  $> 2$  cm or if there is local invasion, some recommend total gastrectomy, whereas others recommend antrectomy in type 1 to reduce the hypergastrinemia; antrectomy produced regression of the carcinoids in a number of studies. For types I and III gastric carcinoids of 1–2 cm, there is no agreement, with some recommending endoscopic treatment, others surgical treatment. With type III gastric carcinoids  $> 2$  cm, excision and regional lymph node clearance is recommended. Most tumors  $< 1$  cm are treated endoscopically.

Resection of isolated or limited hepatic metastases may be beneficial (see later).

### PANCREATIC ENDOCRINE TUMORS

Functional PETs usually present clinically with symptoms due to the hormone-excess state. Only late in the course of the disease does the tumor per se cause prominent symptoms such as abdominal pain. In contrast, all of the symptoms due to nonfunctional PETs are due to the tumor per se. The overall result of this is that some functional PETs may present with severe symptoms with a small or undetectable primary tumor, whereas nonfunctional tumors almost always present late in their disease course with large tumors, which are usually metastatic. The mean delay between onset of continuous symptoms and diagnosis of a functional PET syndrome is 4–7 years. Therefore, the diagnoses are frequently missed for extended periods of time.

#### **Rx** Treatment: PANCREATIC ENDOCRINE TUMOR

Treatment of PETs requires two different strategies. (1) Treatment must be directed at the hormone excess state, such as the gastric acid hypersecretion in gastrinomas or hypoglycemia in insulinomas. Ectopic hormone secretion usually causes the presenting symptoms and can cause life-threatening complications. (2) With all of

the tumors except insulinomas, >50% are malignant (Table 46-2); therefore, treatment must also be directed against the tumor itself. Because these tumors are frequently widespread, surgical resection for cure, which addresses both treatment aspects, is not possible.

## GASTRINOMA (ZOLLINGER-ELLISON SYNDROME)

A gastrinoma is a NET that secretes gastrin; the resultant hypergastrinemia causes gastric acid hypersecretion (ZES). The chronic gastric acid hypersecretion leads to growth of the gastric mucosa with increased numbers of parietal cells and proliferation of gastric ECL cells. The gastric acid hypersecretion characteristically causes peptic ulcer disease (PUD), often refractory and severe, as well as diarrhea. The most common presenting symptoms are abdominal pain (70–100%), diarrhea (37–73%), and gastroesophageal reflux disease (GERD) (30–35%); 10–20% have diarrhea only. Although peptic ulcers may occur in unusual locations, most patients have a typical duodenal ulcer. Important observations that should suggest this diagnosis include PUD with diarrhea; PUD in an unusual location or with multiple ulcers; and PUD refractory to treatment, associated with prominent gastric folds, associated with findings suggestive of MEN1 (endocrinopathy, family history of ulcer or endocrinopathy, nephrolithiasis), or without *Helicobacter pylori* present. *H. pylori* is present in >90% of idiopathic peptic ulcers but is present in <50% of patients with gastrinomas. Chronic unexplained diarrhea should also suggest gastrinoma.

About 20–25% of patients have MEN1, and in most cases hyperparathyroidism is present prior to the gastrinoma. These patients are treated differently from those without MEN1; therefore, MEN1 should be sought in all patients by family history, by measuring plasma ionized calcium and prolactin levels and plasma hormone levels (parathormone, growth hormone).

Most gastrinomas (50–70%) are present in the duodenum, followed by the pancreas (20–40%) and other intraabdominal sites (mesentery, lymph nodes, biliary tract, liver, stomach, ovary). Three cases with two extraabdominal sites have been described: gastrinomas of the left ventricular septum of the heart and non-small cell lung cancer. In MEN1, the gastrinomas are also usually in the duodenum (70–90%) or the pancreas (10–30%), and they are almost always multiple. About 60–90% of gastrinomas are malignant (Table 46-2) with metastatic spread to lymph nodes and liver. Distant metastases to bone occur in 12–30% of patients with liver metastases.

### Diagnosis

The diagnosis of gastrinoma requires the demonstration of fasting hypergastrinemia and an increased basal gastric

acid output (BAO) (hyperchlorhydria). More than 98% of patients with gastrinomas have fasting hypergastrinemia, although in 40–60% the level may be less than tenfold elevated. Therefore, when the diagnosis is suspected, a fasting gastrin level should be determined first. Potent gastric acid-suppressant drugs such as proton pump inhibitors (e.g., omeprazole, esomeprazole) can suppress acid secretion sufficiently to cause hypergastrinemia; because of their prolonged duration of action, the drugs need to be discontinued for a week before the gastrin determination. If the gastrin level is elevated, it is important to show it is increased when gastric pH  $\leq$  2.0; physiologic hypergastrinemia secondary to achlorhydria (atrophic gastritis, pernicious anemia) is one of the most common causes of hypergastrinemia. Nearly all gastrinoma patients have a fasting pH  $\leq$  2 when off antisecretory drugs. If the fasting gastrin >1000 ng/L (10 times increased) and the pH  $\leq$  2.0, which occurs in 40–60% of patients with gastrinoma, the diagnosis is established after ruling out the possibility of retained antrum syndrome by history. In patients with hypergastrinemia with fasting gastrin <1000 ng/L and gastric pH  $\leq$  2.0, other conditions such as *H. pylori* infections, antral G cell hyperplasia/hyperfunction, gastric outlet obstruction, or rarely, renal failure can masquerade as a gastrinoma. To establish the diagnosis in this group, a determination of BAO and a secretin stimulation test should be done. In patients with gastrinomas without previous gastric acid-reducing surgery, the BAO is usually (>90%) elevated (i.e., >15 meq/h). The secretin stimulation test is usually positive, with the criterion of >120 ng/L increase over the basal level having the highest sensitivity (94%) and specificity (100%).

### **Rx** Treatment: GASTRINOMAS

Gastric acid hypersecretion in patients with gastrinomas can be controlled in almost every case by oral gastric antisecretory drugs. Because of their long duration of action and potency, allowing once or twice a day dosing, the proton pump inhibitors are the drugs of choice. Histamine H<sub>2</sub>-receptor antagonists are also effective, although more frequent dosing (q4–8h) and high doses are frequently required. In patients with MEN1 with hyperparathyroidism, correction of the hyperparathyroidism increases the sensitivity to gastric antisecretory drugs and decreases the basal acid output.

With the increased ability to control acid hypersecretion, >50% of the patients who are not cured (>60% of patients) will die from tumor-related causes. At presentation careful imaging studies are essential to localize the extent of the tumor. A third of patients present with hepatic metastases, and in <15% of those with hepatic

metastases the disease is limited, so that surgical resection may be possible. Surgical cure is possible in 30% of patients without MEN1 or liver metastases (40% of all patients). In patients with MEN1, long-term surgical cure is rare because the tumors are multiple, frequently with lymph node metastases. Therefore, all patients with gastrinomas without MEN1 or a medical condition limiting life expectancy should undergo surgery by an experienced surgeon.

## INSULINOMAS

An insulinoma is an endocrine tumor of the pancreas derived from beta cells that ectopically secretes insulin, which results in hypoglycemia. The average age of occurrence is 40–50 years. The most common clinical symptoms are due to the effect of the hypoglycemia on the central nervous system (neuroglycemic symptoms) and include confusion, headache, disorientation, visual difficulties, irrational behavior, or even coma. Also, most patients have symptoms due to excess catecholamine release secondary to the hypoglycemia including sweating, tremor, and palpitations. Characteristically these attacks are associated with fasting.

Insulinomas are generally small (>90% < 2 cm), usually not multiple (90%), and only 5–15% are malignant; they almost invariably occur only in the pancreas, distributed equally in the pancreatic head, body, and tail.

Insulinomas should be suspected in all patients with hypoglycemia, especially with a history suggesting attacks provoked by fasting or with a family history of MEN1. Insulin is synthesized as proinsulin, a 21-amino-acid  $\alpha$ -chain and a 30-amino-acid  $\beta$ -chain connected by a 33-amino-acid connecting peptide (C peptide). In insulinomas, in addition to elevated plasma insulin levels, elevated plasma proinsulin levels are found and C-peptide levels can be elevated.

### Diagnosis

The diagnosis of insulinoma requires the demonstration of an elevated plasma insulin level at the time of hypoglycemia. A number of other conditions may cause fasting hypoglycemia, such as the inadvertent or surreptitious use of insulin or oral hypoglycemic agents, severe liver disease, alcoholism, poor nutrition, or other extrapancreatic tumors. The most reliable test to diagnose insulinoma is a fast up to 72 h with serum glucose, C-peptide, and insulin measurements every 4–8 h. If at any point the patient becomes symptomatic or glucose levels are persistently <2.2 mmol/L (40 mg/dL), the test should be terminated and repeat samples for the studies just cited obtained before glucose is given. Some 70–80% of patients develop hypoglycemia during the first 24 h and 98% by 48 h. In nonobese normal subjects, serum

insulin levels should decrease to <43 pmol/L (<6  $\mu$ U/mL) when blood glucose decreases to  $\leq$ 2.2 mmol/L ( $\leq$ 40 mg/dL) and the ratio of insulin to glucose is <0.3 (in mg/dL). In addition to having an insulin level >6  $\mu$ U/mL when blood glucose is  $\leq$ 40 mg/dL, some investigators also require an elevated C-peptide and serum proinsulin level, an insulin/glucose ratio >0.3, and a decreased plasma  $\beta$ -hydroxybutyrate level for the diagnosis of insulinomas. Surreptitious use of insulin or hypoglycemic agents may be difficult to distinguish from insulinomas. The combination of proinsulin levels (normal in exogenous insulin/hypoglycemic agent users), C-peptide levels (low in exogenous insulin users), antibodies to insulin (positive in exogenous insulin users), and measurement of sulfonylurea levels in serum or plasma will allow the correct diagnosis to be made. The diagnosis of insulinoma has been complicated by the introduction of specific insulin assays that do not also interact with proinsulin, as do many of the older radioimmunoassays (RIAs), and therefore give lower plasma insulin levels. The increased use of these specific insulin assays has resulted in increased numbers of patients with insulinomas having lower plasma insulin values than the 43 pmol/L (6  $\mu$ U/mL) levels proposed to be characteristic of insulinomas by RIA. In these patients the assessment of proinsulin and C-peptide levels at the time of hypoglycemia are particularly helpful for establishing the correct diagnosis.

### **Rx** Treatment: INSULINOMAS

Only 5–15% of insulinomas are malignant; therefore, after appropriate imaging (see later), surgery should be performed. In different studies, 75–95% of patients are cured by surgery. Before surgery, the hypoglycemia can be controlled by frequent small meals and the use of diazoxide (150–800 mg/d). Diazoxide is a benzothiadiazide whose hyperglycemic effect is attributed to inhibition of insulin release. Its side effects are sodium retention and GI symptoms such as nausea. Approximately 50–60% of patients respond to diazoxide. Other agents effective in some patients to control the hypoglycemia include verapamil and diphenylhydantoin. Long-acting somatostatin analogues such as octreotide are acutely effective in 40% of patients. However, octreotide needs to be used with care because it inhibits growth hormone secretion and can alter plasma glucagon levels; therefore, in some patients it can worsen the hypoglycemia.

For the 5–15% of patients with malignant insulinomas, the drugs just listed or somatostatin analogues are used initially. If they are not effective, various anti-tumor treatments such as hepatic arterial embolization, chemoembolization, or chemotherapy have been used (see later).



A glucagonoma is an endocrine tumor of the pancreas that secretes excessive amounts of glucagon, which causes a distinct syndrome characterized by dermatitis, glucose intolerance or diabetes, and weight loss. Glucagonomas principally occur between 45 and 70 years of age. The tumor is clinically heralded by a characteristic dermatitis (migratory necrolytic erythema) (67–90%), accompanied by glucose intolerance (40–90%), weight loss (66–96%), anemia (33–85%), diarrhea (15–29%), and thromboembolism (11–24%). The rash starts usually as an annular erythema at intertriginous and periorificial sites, especially in the groin or buttock. It subsequently becomes raised and bullae form; when the bullae rupture, eroded areas form. The lesions can wax and wane. A characteristic laboratory finding is hypoaminoacidemia, which occurs in 26–100% of patients.

Glucagonomas are generally large tumors (5–10 cm) at diagnosis. Some 50–80% occur in the pancreatic tail. From 50–82% have evidence of metastatic spread at presentation, usually to the liver. Glucagonomas are rarely extrapancreatic and usually occur singly.

### Diagnosis

The diagnosis is confirmed by demonstrating an increased plasma glucagon level (normal is <150 ng/L). Plasma glucagon levels are >1000 ng/L in 90%, between 500 and 1000 ng/L in 7%, and <500 ng/L in 3%. A plasma glucagon level >1000 ng/L is considered diagnostic of glucagonoma. Other diseases causing increased plasma glucagon levels include renal insufficiency, acute pancreatitis, hypercorticism, hepatic insufficiency, prolonged fasting, or familial hyperglucagonemia. With the exception of cirrhosis, these disorders do not increase plasma glucagon to >500 ng/L.

#### **R<sub>x</sub>** Treatment: **GLUCAGONOMAS**

In 50–80% of patients, metastases are present, so curative surgical resection is not possible. Surgical debulking in patients with advanced disease or other anti-tumor treatments may be beneficial (see later). Long-acting somatostatin analogues such as octreotide or lanreotide improve the skin rash in 75% of patients and may improve the weight loss, pain, and diarrhea but usually do not improve the glucose intolerance.

### SOMATOSTATINOMA SYNDROME

The somatostatinoma syndrome is due to a NET that secretes excessive amounts of somatostatin, which causes a distinct syndrome characterized by diabetes mellitus,

gallbladder disease, diarrhea, and steatorrhea. There is no general distinction in the literature between a tumor that contains somatostatin-like immunoreactivity (somatostatinoma) and does (11–45%), or does not (55–89%) produce a clinical syndrome (somatostatinoma syndrome) by secreting somatostatin. In one review of 173 cases of somatostatinomas, only 11% were associated with the somatostatinoma syndrome. The mean age of patients is 51 years. Somatostatinomas occur primarily in the pancreas and small intestine, and the frequency of the symptoms differs in each. Each of the usual symptoms is more frequent in pancreatic than intestinal somatostatinomas: diabetes mellitus (95% vs 21%), gallbladder disease (94% vs 43%), diarrhea (92% vs 38%), steatorrhea (83% vs 12%), hypochlorhydria (86% vs 12%), and weight loss (90% vs 69%). Somatostatinomas occur in the pancreas in 56–74% of cases, with the primary location in the pancreatic head. The tumors are usually solitary (90%) and large, with a mean size of 4.5 cm. Liver metastases are frequent, present in 69–84% of patients.

Somatostatin is a tetradecapeptide that is widely distributed in the central nervous system and GI tract, where it functions as a neurotransmitter or has paracrine and autocrine actions. It is a potent inhibitor of many processes including release of almost all hormones, acid secretion, intestinal and pancreatic secretion, and intestinal absorption. Most of the clinical manifestations are directly related to these inhibitory actions.

### Diagnosis

In most cases somatostatinomas have been found by accident either at the time of cholecystectomy or during endoscopy. The presence of psammoma bodies in a duodenal tumor should particularly raise suspicion. Duodenal somatostatin-containing tumors are increasingly associated with von Recklinghausen's disease. Most of these do not cause the somatostatinoma syndrome. The diagnosis of the somatostatinoma syndrome requires the demonstration of elevated plasma somatostatin levels.

#### **R<sub>x</sub>** Treatment: **SOMATOSTATINOMAS**

Pancreatic tumors are frequently (70–92%) metastatic at presentation, whereas 30–69% of small-intestinal somatostatinomas have metastases. Surgery is the treatment of choice for those without widespread hepatic metastases. Symptoms in patients with the somatostatinoma syndrome are improved by octreotide treatment.

### VIPomas

VIPomas are endocrine tumors that secrete excessive amounts of VIP, which causes a distinct syndrome characterized by large-volume diarrhea, hypokalemia, and

dehydration. This syndrome is also called Verner-Morrison syndrome, pancreatic cholera, and WDHA syndrome for *watery diarrhea, hypokalemia, and achlorhydria*, which some patients develop. The mean age of patients with this syndrome is 49 years; however, it can occur in children and when it does, it is usually caused by a ganglioneuroma or ganglioneuroblastoma.

The principal symptoms are large-volume diarrhea (100%) severe enough to cause hypokalemia (80–100%), dehydration (83%), hypochlorhydria (54–76%), and flushing (20%). The diarrhea is secretory in nature, persisting during fasting, is almost always >1 L/d and >3 L/d in 70%. Most patients do not have accompanying steatorrhea (16%), and the increased stool volume is due to increased excretion of sodium and potassium, which, with the anions, account for the osmolality of the stool. Patients frequently have hyperglycemia (25–50%) and hypercalcemia (25–50%).

VIP is a 28-amino-acid peptide important as a neurotransmitter, ubiquitously present in the central nervous system and GI tract. Its known actions include stimulation of small-intestinal chloride secretion, effects on smooth-muscle contractility, inhibition of acid secretion, and vasodilatory effects, which explain most features of the clinical syndrome.

In adults 80–90% of VIPomas are pancreatic in location, with the rest due to VIP-secreting pheochromocytomas, intestinal carcinoids, and, rarely, ganglioneuromas. These tumors are usually solitary, 50–75% are in the pancreatic tail, and 37–68% have hepatic metastases at diagnosis. In children <10 years old, the syndrome is usually due to ganglioneuromas or ganglioblastomas and is less often malignant (10%).

### Diagnosis

The diagnosis requires the demonstration of an elevated plasma VIP level and the presence of large-volume diarrhea. A stool volume of <700 mL/day is proposed to exclude the diagnosis of VIPoma. By fasting the patient, a number of causes can be excluded that cause marked diarrhea. Other diseases that can give a secretory large-volume diarrhea include gastrinomas, chronic laxative abuse, carcinoid syndrome, systemic mastocytosis, rarely medullary thyroid cancer, diabetes, and AIDS. Of these conditions, only VIPomas cause a marked increase in plasma VIP.

### **R<sub>x</sub>** Treatment: VASOACTIVE INTESTINAL PEPTIDOMAS

The most important initial treatment in these patients is to correct their dehydration, hypokalemia, and electrolyte losses with fluid and electrolyte replacement. These patients may require 5 L/d of fluid and >350 meq/day of potassium. Because 37–68% of adults with VIPomas

have metastatic disease in the liver at presentation, a significant number of patients cannot be cured surgically. In these patients long-acting somatostatin analogues such as octreotide or lanreotide are the drugs of choice.

Octreotide controls the diarrhea in 87% of patients. In nonresponsive patients the combination of glucocorticoids and octreotide has proved helpful in a small number of patients. Other drugs reported to be helpful in small numbers of patients include prednisone (60–100 mg/d), clonidine, indomethacin, phenothiazines, loperamide, lidamide, lithium, propranolol, and metoclopramide. Treatment of advanced disease with embolization, chemoembolization, and chemotherapy may also be helpful (see later).

### NONFUNCTIONAL PANCREATIC ENDOCRINE TUMORS

Nonfunctional PETs are endocrine tumors that originate in the pancreas and either secrete no products or their products do not cause a specific clinical syndrome. The symptoms are due entirely to the tumor per se. Nonfunctional PETs secrete chromogranin A (90–100%), chromogranin B (90–100%), PP (58%),  $\alpha$ -hCG (40%), and  $\beta$ -hCG (20%). Because the symptoms are due to the tumor alone, patients with nonfunctional PETs usually present late in their disease course with invasive tumors and hepatic metastases (64–92%), and the tumors are usually large (72% >5 cm). The tumors are usually solitary except in patients with MEN1, where they are multiple. They occur primarily in the pancreatic head. Even though these tumors do not cause a functional syndrome, immunocytochemical studies show they synthesize numerous peptides and cannot be distinguished from functional tumors by immunocytochemistry.

The most common symptoms are abdominal pain (30–80%); jaundice (20–35%); weight loss, fatigue, or bleeding; and 10–15% are found incidentally. The average time from the beginning of symptoms to diagnosis is 5 years.

### Diagnosis

The diagnosis is established by histologic confirmation in a patient without either clinical symptoms or elevated plasma hormone levels. Even though chromogranin A levels are elevated in almost every patient, this is not specific for this disease because it can be found in functional PETs, carcinoids, and other neuroendocrine disorders. Plasma PP is increased in 22–71% of patients and should strongly suggest the diagnosis in a patient with a pancreatic mass because it is usually normal in patients with pancreatic adenocarcinomas. Elevated plasma PP is

594 not diagnostic of this tumor because it is elevated in a number of other conditions such as chronic renal failure, old age, inflammatory conditions, and diabetes.

**Treatment:**  
**Rx NONFUNCTIONAL PANCREATIC ENDOCRINE TUMORS**

Unfortunately, surgical curative resection can be considered only in the minority of the patients because 64–92% present with metastatic disease. Treatment is directed against the tumor per se using chemotherapy, embolization, chemoembolization, or hormonal therapy (see later).

### GRFomas

GRFomas are endocrine tumors that secrete excessive amounts of GRF that causes acromegaly. The true frequency of this syndrome is not known. GRF is a 44-amino-acid peptide, and 25–44% of PETs have GRF immunoreactivity, although it is uncommonly secreted. GRFomas are lung tumors in 47–54% of cases, PETs in 29–30%, and small-intestinal carcinoids in 8–10%; up to 12% occur at other sites. Patients have a mean age of 38 years, and the symptoms are usually due to either acromegaly or the tumor itself. The acromegaly caused by GRFomas is indistinguishable from classic acromegaly. The pancreatic tumors are usually large (>6 cm), and liver metastases are present in 39%. They should be suspected in any patient with acromegaly and an abdominal tumor, in a patient with MEN1 with acromegaly, or in a patient without a pituitary adenoma with acromegaly or associated with hyperprolactinemia, which occurs in 70% of GRFomas. GRFomas are an uncommon cause of acromegaly. The diagnosis is established by performing plasma assays for GRF and growth hormone. The normal level for GRF is <5 µg/L in men and <10 µg/L in women. Most GRFomas have a plasma GRF level ≥300 µg/L. Patients with GRFomas also have increased plasma insulin-like growth factor 1 levels similar to those in classic acromegaly. Surgery is the treatment of choice if diffuse metastases are not present. Long-acting somatostatin analogues such as octreotide or lanreotide are the agents of choice, with 75–100% of patients responding.

### OTHER RARE PANCREATIC ENDOCRINE TUMOR SYNDROMES

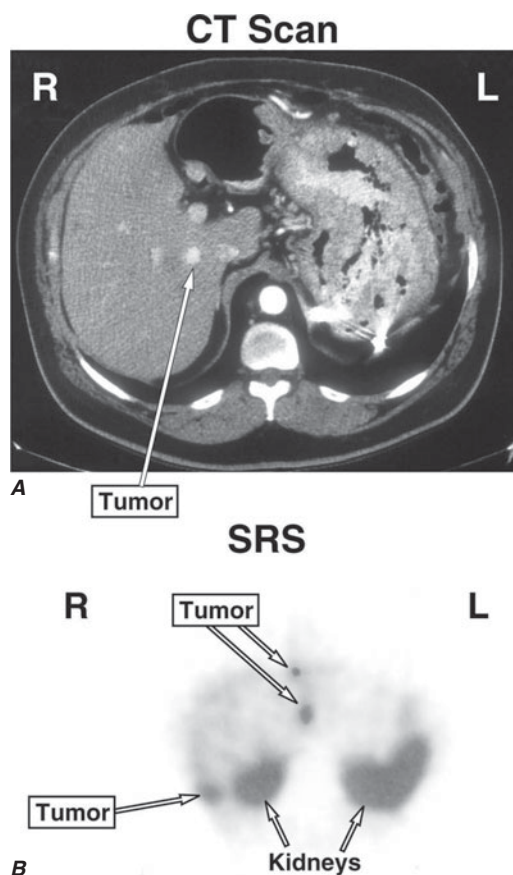
Cushing's syndrome (ACTHoma) due to a PET occurs in 4–16% of all ectopic Cushing's syndrome cases. It occurs in 5% of cases of sporadic gastrinomas, almost invariably in patients with hepatic metastases, and is an independent poor prognostic factor. Paraneoplastic hypercalcemia due to PETs releasing parathyroid hormone-related peptide

(PTHrP), a PTH-like material, or unknown factor, is rarely reported. The tumors are usually large, and liver metastases are usually present. Most (88%) appear to be due to release of PTHrP. PETs can occasionally cause the carcinoid syndrome. PETs secreting calcitonin have been proposed as a specific clinical syndrome. Half of the patients have diarrhea, which disappears with resection of the tumor. The proposal that this could be a discrete syndrome is supported by finding that 25–42% of patients with medullary thyroid cancer with hypercalcitonemia develop diarrhea, likely secondary to a motility disorder. A renin-producing PET has been described in a patient presenting with hypertension; PETs secreting luteinizing hormone, resulting in masculinization or decreased libido, and a PET secreting erythropoietin, resulting in polycythemia have also been reported (Table 46-2). Ghrelin is a 28-amino-acid peptide with a number of metabolic and immunologic functions. Although it is detectable immunohistochemically in most PETs, only 1 in 24 patients (4%) with a PET had elevated plasma ghrelin levels in one study and the patient was asymptomatic. Release of ghrelin by a PET may be clinically silent.

### TUMOR LOCALIZATION

Localization of the primary tumor and defining the extent of disease are essential to the proper management of all carcinoids and PETs. Numerous tumor localization methods are used in both types of NETs, including conventional imaging studies (CT, MRI, transabdominal ultrasound, selective angiography), somatostatin receptor scintigraphy (SRS), and positron emission tomographic scanning. In PETs, endoscopic ultrasound (EUS) and functional localization by measuring venous hormonal gradients are also reported useful. Bronchial carcinoids are usually detected by a standard chest radiography and assessed by CT. Rectal, duodenal, colonic, and gastric carcinoids are usually detected by GI endoscopy.

PETs, as well as carcinoid tumors, frequently overexpress high-affinity somatostatin receptors in both their primary tumors and their metastases. Of the five types of somatostatin receptors (sst<sub>1-5</sub>), radiolabeled octreotide binds with high affinity to sst<sub>2</sub> and sst<sub>5</sub>, lower for sst<sub>3</sub>, and has a very low affinity for sst<sub>1</sub> and sst<sub>4</sub>. Between 90% and 100% of carcinoid tumors and PETs possess sst<sub>2</sub>, and many also have the other four sst subtypes. Interaction with these receptors can be used to localize NETs using [<sup>111</sup>In-DTPA-D-Phe<sup>1</sup>]octreotide and radionuclide scanning (SRS) as well as for treatment of the hormone excess state with octreotide or lanreotide, as discussed earlier. Because of its sensitivity and ability to localize tumor throughout the body, SRS is now the initial imaging modality of choice for localizing both primary and metastatic NETs. SRS localizes tumor in 73–89% of patients with carcinoids and in 56–100% of patients



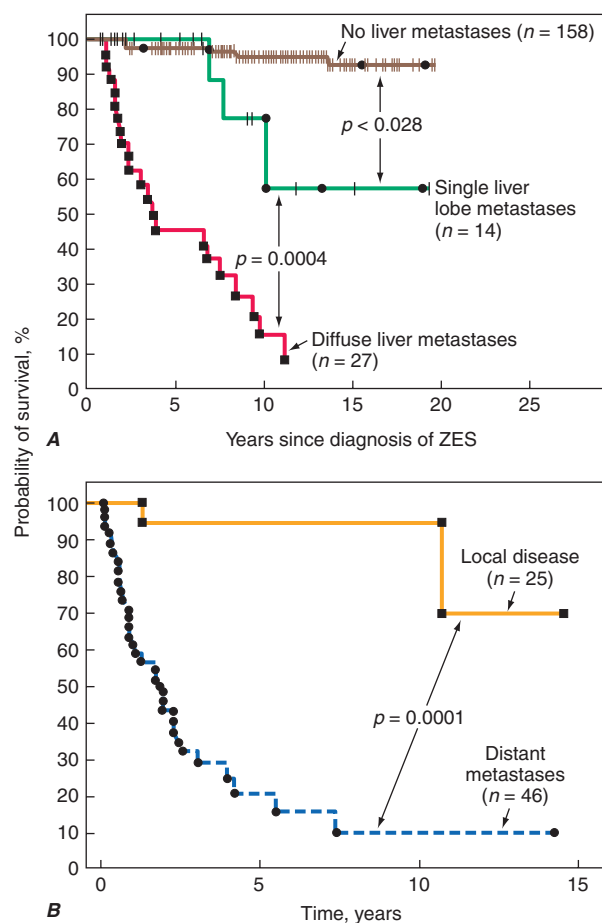
**FIGURE 46-3**  
Ability of CT scanning (A) or somatostatin receptor scintigraphy (SRS) (B) to localize metastatic carcinoid in the liver.

with PETs, except for insulinomas. Insulinomas are usually small and have low densities of sst receptors, resulting in SRS being positive in only 12–50% of patients with insulinomas. **Figure 46-3** shows an example of the increased sensitivity of SRS in a patient with a carcinoid tumor. The CT scan (Fig. 46-3A) shows a single liver metastasis, whereas the SRS demonstrates three metastases in the liver in multiple locations (Fig. 46-3B). Occasional false-positive responses with SRS can occur (12% in one study) because numerous other normal tissues and diseases can have high densities of sst receptors, including granulomas (sarcoid, TB, etc.), thyroid diseases (goiter, thyroiditis), and activated lymphocytes (lymphomas, wound infections). For PETs located in the pancreas, EUS is highly sensitive, localizing 77–93% of insulinomas, which occur almost exclusively within the pancreas. EUS is less sensitive for extrapancreatic tumors. If liver metastases are identified by SRS, either a CT or MRI is then recommended to assess the size and exact location of the metastases because SRS does not give information on tumor size. Functional localization measuring hormone gradients after intraarterial calcium

injections in insulinomas (insulin) or gastrin gradients after secretin injections in gastrinoma is a sensitive method, positive in 80–100% of patients. However, this method gives only regional localization and therefore is reserved for cases where other imaging modalities are negative. Positron emission tomographic scanning with  $^{18}\text{F}$ -fluoro-DOPA in patients with carcinoids or with  $^{11}\text{C}$ -5HTP in patients with PETs or carcinoids has greater sensitivity than conventional imaging studies or SRS and will likely be used increasingly in the future.

**R<sub>x</sub> Treatment:**  
**ADVANCED DISEASE (DIFFUSE METASTATIC DISEASE)**

The single most important prognostic factor for survival is the presence of liver metastases (**Fig. 46-4**). For patients with foregut carcinoids without hepatic metastases, the 5-year survival in one study was 95% and with distant



**FIGURE 46-4**  
Effect of the presence and extent of liver metastases on survival in patients with gastrinomas (A) or carcinoid tumors (B). ZES, Zollinger-Ellison syndrome. (A is drawn from data from 199 patients with gastrinomas modified from F Yu et al: *J Clin Oncol* 17:615, 1999. B is drawn from data from 71 patients with foregut carcinoid tumors from EW McDermott et al: *Br J Surg* 81:1007, 1994.)

metastases, 20%. With gastrinomas, the 5-year survival without liver metastases is 98%, with limited metastases in one hepatic lobe it is 78%, and with diffuse metastases, 16%. A number of different modalities are reported to be effective in advanced disease including cytoreductive surgery (removal of all visible tumor), treatment with chemotherapy, somatostatin analogues, IFN- $\alpha$ , hepatic embolization alone or with chemotherapy (chemoembolization), radiotherapy, and liver transplantation.

**SPECIFIC ANTITUMOR TREATMENTS** Cytoreductive surgery, unfortunately, is only possible in the 9–22% of patients who have limited hepatic metastases. Although no randomized studies have proven that hepatic resection extends life, results from a number of studies suggest it likely increases survival and therefore is recommended, if possible.

Chemotherapy for metastatic carcinoid tumors has generally been disappointing, with response rates of 0–40% with various two- or three-drug combinations. Chemotherapy for PETs has been more successful with tumor shrinkage reported in 30–70% of patients. The current regimen of choice is streptozotocin and doxorubicin.

Long-acting somatostatin analogues such as octreotide, lanreotide, and IFN- $\alpha$  rarely decrease tumor size (i.e., 0–17%); however, these drugs have tumorstatic effects, stopping additional growth in 26–95% of patients with NETs. How long tumor stabilization lasts or whether it prolongs survival has not been established.

Hepatic embolization and chemoembolization (with dacarbazine, cisplatin, doxorubicin, 5-fluorouracil, or streptozotocin) have been reported to decrease tumor bulk and to help control the symptoms of the hormone-excess state. These modalities are generally reserved for cases in which treatment with somatostatin analogues, IFN- $\alpha$  (carcinoids), or chemotherapy (PETs) fails. Embolization, when combined with treatment with octreotide and IFN- $\alpha$ , significantly reduces tumor progression ( $p = 0.008$ ) over treatment with embolization and octreotide alone in patients with advanced midgut carcinoids.

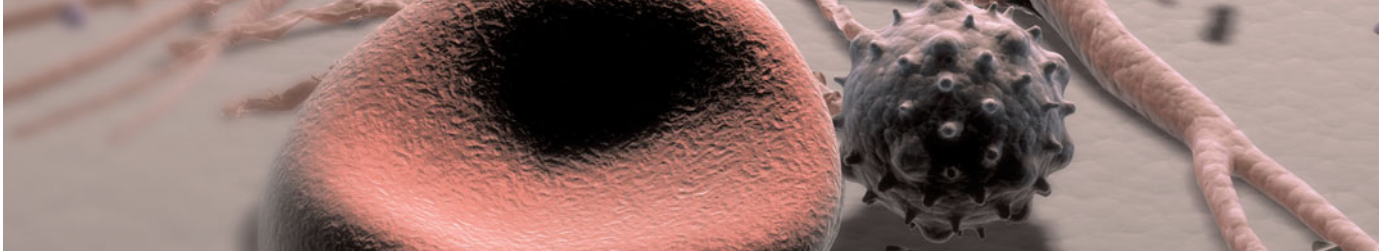
Radiotherapy with radiolabeled somatostatin analogues that are internalized by the tumors is an approach under investigation. Three different radionuclides are being used: (1) high doses of [ $^{111}\text{In}$ -DTPA-D-Phe $^1$ ]octreotide (Fig. 46-2), which emits  $\gamma$ -rays, internal

conversion, and Auger electrons; yttrium-90, which emits high-energy  $\beta$ -particles coupled by a DOTA chelating group to octreotide or octreotate; and (3)  $^{177}\text{Lu}$ -coupled analogues, which emit both  $\beta$ - and  $\gamma$ -rays. All are being tested. Tumor stabilization is reported in 41–81%, 44–88%, and 23–40%, respectively, and a decrease in tumor size in 8–30%, 6–37%, and 38%, respectively, of patients with advanced metastatic NETs. These results suggest this novel therapy may be helpful, especially in patients with advanced metastatic disease.

The use of liver transplantation has been abandoned for treatment of most metastatic tumors to the liver. However, for metastatic NETs it is still a consideration. In a review of 103 cases of malignant NETs (48 PETs, 43 carcinoids), the 2- and 5-year survival rates were 60% and 47%, respectively. However, recurrence-free survival was low (<24%). It was concluded that for younger patients with metastatic NETs limited to the liver, liver transplantation may be justified.

## FURTHER READINGS

- AGGARWAL G et al: Carcinoid tumors: What should increase our suspicion? *Cleve Clin J Med* 75:849, 2008
- DAVIES K, CONLON KC: Neuroendocrine tumors of the pancreas. *Curr Gastroenterol Rep* 11:119, 2009
- EHEHALT F et al: Neuroendocrine tumors of the pancreas. *Oncologist* 14:456, 2009
- FORRER F et al: Peptide receptor radiotherapy. *Best Practice Res Clin Endocrinol Metab* 21:111, 2007
- JENSEN RT, DOHERTY GM: Carcinoid tumors and the carcinoid syndrome, in *Cancer: Principles and Practice of Oncology*, 7th ed, VT DeVita Jr, S Hellman, SA Rosenberg (eds). Philadelphia, Lippincott Williams and Wilkins, 2005, pp 1559–1574
- MODLIN IM et al: Therapeutic options for gastrointestinal carcinoids. *Clin Gastrointest Hepatol* 4:526, 2006
- OBERG K: Somatostatin analog octreotide LAR in gastro-enteropancreatic tumors. *Expert Rev Anticancer Ther* 9:557, 2009
- OBERG K, ERIKSSON B: Neuroendocrine tumors. *Best Pract Res Clin Endocrinol Metabol* 21:1, 2007
- RINDI G, BORDI C: Aetiology, molecular pathogenesis and genetics. *Best Pract Res Clin Gastroenterol* 19:519, 2005
- et al (ed): Consensus guidelines on the management of patients with digestive neuroendocrine tumors. *Neuroendocrinology* 84:151, 2006
- STARKER LE, CARLING T: Molecular genetics of gastroenteropancreatic neuroendocrine tumors. *Curr Opin Oncol* 21:29, 2009



## CHAPTER 47

# MULTIPLE ENDOCRINE NEOPLASIA

Camilo Jimenez ■ Robert F. Gagel

■ Neoplastic Disorders Affecting Multiple Endocrine Organs . . . . .	.597	■ Immunologic Syndromes Affecting Multiple Endocrine Organs . . . . .	.605
Multiple Endocrine Neoplasia (MEN) Type 1 . . . . .	.598	Polyglandular Autoimmune Syndrome Type I . . . . .	.606
Genetic Considerations . . . . .	.600	Polyglandular Autoimmune Syndrome Type II . . . . .	.606
Multiple Endocrine Neoplasia Type 2 . . . . .	.601	Diagnosis . . . . .	.607
Genetic Considerations . . . . .	.602	Other Autoimmune Endocrine Syndromes . . . . .	.607
Other Genetic Endocrine Tumor Syndromes . . . . .	.605	■ Further Readings . . . . .	.608

### NEOPLASTIC DISORDERS AFFECTING MULTIPLE ENDOCRINE ORGANS

Multiple endocrine neoplasia syndrome is defined as a disorder with neoplasms in two or more different hormonal tissues in several members of a family. Several distinct

genetic disorders predispose to endocrine gland neoplasia and cause hormone excess syndromes (Table 47-1). DNA-based genetic testing is now available for these disorders, but effective management requires an understanding of endocrine neoplasia and the range of clinical features that may be manifested in an individual patient.

**TABLE 47-1**

**DISEASE ASSOCIATIONS IN THE MULTIPLE ENDOCRINE NEOPLASIA (MEN) SYNDROMES**

MEN1	MEN2	MIXED SYNDROMES
Parathyroid hyperplasia or adenoma	<b>MEN2A</b>	<b>Von Hippel-Lindau syndrome</b>
Islet cell hyperplasia, adenoma, or carcinoma	MTC	Pheochromocytoma
Pituitary hyperplasia or adenoma	Pheochromocytoma	Islet cell tumor
Other less common manifestations: foregut carcinoid, pheochromocytoma, subcutaneous or visceral lipomas	Parathyroid hyperplasia or adenoma	Renal cell carcinoma
	<b>MEN2A with cutaneous lichen amyloidosis</b>	Hemangioblastoma of central nervous system
	<b>MEN2A with Hirschsprung disease</b>	Retinal angiomas
	<b>Familial MTC</b>	<b>Neurofibromatosis with features of MEN1 or 2</b>
	<b>MEN2B</b>	<b>Carney complex</b>
	MTC	Myxomas of heart, skin, and breast
	Pheochromocytoma	Spotty cutaneous pigmentation
	Mucosal and gastrointestinal neuromas	Testicular, adrenal, and GH-producing pituitary tumors
	Marfanoid features	Peripheral nerve schwannomas

**Note:** GH, growth hormone; MTC, medullary thyroid carcinoma.

MEN1, or Wermer's syndrome, is inherited as an autosomal dominant trait. This syndrome is characterized by neoplasia of the parathyroid glands, enteropancreatic tumors, anterior pituitary adenomas, and other neuroendocrine tumors with variable penetrance (Table 47-1). Although rare, MEN1 is the most common multiple endocrine neoplasia syndrome with an estimated prevalence of 2–20 per 100,000 in the general population. This syndrome is caused by inactivating mutations of the tumor-suppressor gene *MEN1* located at chromosome 11q13. The *MEN1* gene codes for a nuclear protein called Menin. Menin interacts with JunD, suppressing the JunD-dependent transcriptional activation. It is unclear how this accounts for Menin growth regulatory activity because JunD is associated with inhibition of cell growth. Each child born to an affected parent has a 50% probability of inheriting the gene. The variable penetrance of the several neoplastic components can make the differential diagnosis and treatment challenging.

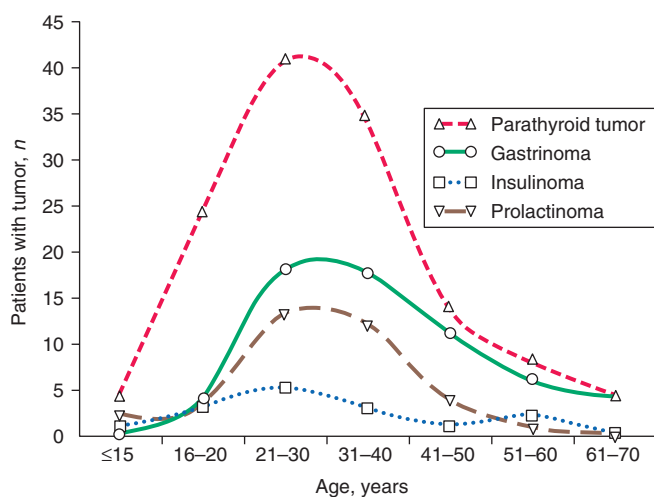
### Clinical Manifestations

*Primary hyperparathyroidism* is the most common manifestation of MEN1, with an estimated penetrance of 95–100%. Hypercalcemia may develop during the teenage years, and most individuals are affected by age 40 (Fig. 47-1). Hyperparathyroidism is the earliest

manifestation of the syndrome in most MEN1 patients. The neoplastic changes in hyperparathyroidism provide a specific example of one of the cardinal features of endocrine tumors in MEN1: multicentricity. The neoplastic changes inevitably affect multiple parathyroid glands, making surgical cure difficult. Screening for hyperparathyroidism involves measurement of either an albumin-adjusted or ionized serum calcium level. The diagnosis is established by demonstrating elevated levels of serum calcium and intact parathyroid hormone. Manifestations of hyperparathyroidism of MEN1 do not differ substantially from those in sporadic hyperparathyroidism and include calcium-containing kidney stones, kidney failure, nephrocalcinosis, bone abnormalities (i.e., osteoporosis, osteitis fibrosa cystica), and gastrointestinal and musculoskeletal complaints. Management is challenging because of early onset, significant recurrence rates, and the multiplicity of parathyroid gland involvement. Differentiation of hyperparathyroidism of MEN1 from other forms of familial primary hyperparathyroidism is usually based on family history, histologic features of resected parathyroid tissue, the presence of a *MEN1* mutation and, sometimes, long-term observation to determine whether other manifestations of MEN1 develop. Parathyroid hyperplasia is the most common cause of hyperparathyroidism in MEN1, although single and multiple adenomas have been described. Hyperplasia of one or more parathyroid glands is common in younger patients; adenomas are usually found in older patients or those with long-standing disease.

*Enteropancreatic tumors* are the second most common manifestation of MEN1, with an estimated penetrance of 50%. They tend to occur in parallel with hyperparathyroidism (Fig. 47-1); 30% are malignant. Most of these tumors secrete peptide hormones that cause specific clinical syndromes. These syndromes, however, may have an insidious onset and a slow progression, making their diagnosis difficult and in many cases delayed. Some enteropancreatic tumors do not secrete hormones. These “silent” tumors are usually found during radiographic screening. Metastasis, most commonly to the liver, is not uncommon.

*Gastrinomas* are the most common enteropancreatic tumors observed in MEN1 patients and result in the Zollinger-Ellison syndrome (ZES). ZES is caused by excessive gastrin production and occurs in more than half of MEN1 patients with small carcinoid-like tumors in the duodenal wall or, less often, by pancreatic islet cell tumors. There may be more than one gastrin-producing tumor, making localization difficult. The robust acid production may cause esophagitis, duodenal ulcers throughout the duodenum, ulcers involving the proximal jejunum, and diarrhea. The ulcer diathesis is commonly refractory to conservative therapy such as antacids. The diagnosis is made by finding increased gastric acid secretion, elevated basal gastrin levels in the



**FIGURE 47-1** Age at onset of endocrine tumor expression in multiple endocrine neoplasia type 1 (MEN1). Data derived from retrospective analysis for each endocrine organ hyperfunction in 130 cases of MEN1. Age at onset is the age at first symptom or, with tumors not causing symptoms, age at the time of the first abnormal finding on a screening test. The rate of diagnosis of hyperparathyroidism increased sharply between ages 16 and 20 years. (Reprinted with permission from S Marx et al: *Ann Intern Med* 129:484, 1998.)

serum [generally  $>115$  pmol/L (200 pg/mL)], and an exaggerated response of serum gastrin to either secretin or calcium. Other causes of elevated serum gastrin levels, such as achlorhydria, treatment with  $H_2$  receptor antagonists or proton pump inhibitors, retained gastric antrum, small-bowel resection, gastric outlet obstruction, and hypercalcemia, should be excluded (Fig. 47-1). High-resolution, early-phase CT scanning, abdominal MRI with contrast, octreotide scan, and/or endoscopic ultrasound provide the best preoperative techniques for identification of the primary and metastatic gastrinoma; intraoperative ultrasonography is the most sensitive method for detection of small tumors. Approximately a fourth of all ZES occurs in the context of MEN1.

*Insulinomas* are the second most common enteropancreatic tumors in patients who suffer from MEN1. Unlike gastrinomas, most insulinomas originate in the pancreas bed, becoming the most common pancreatic tumor in MEN1. Hypoglycemia caused by insulinomas is observed in about a third of MEN1 patients with pancreatic islet cell tumors (Fig. 47-1). The tumors may be benign or malignant (25%). The diagnosis can be suggested by documenting hypoglycemia during a short fast with simultaneous inappropriate elevation of serum insulin and C-peptide levels. More commonly, it is necessary to subject the patient to a supervised 12- to 72-h fast to provoke hypoglycemia. Large insulinomas may be identified by CT or MRI scanning; small tumors not detected by conventional radiographic techniques may be localized by endoscopic ultrasound or by selective arteriographic injection of calcium into each of the arteries that supply the pancreas and sampling the hepatic vein for insulin to determine the anatomic region containing the tumor. Intraoperative ultrasonography is frequently used to localize these tumors. The trend to earlier diagnosis of, hence, smaller tumors has reduced the usefulness of octreotide scanning, which is positive in a minority of these patients.

*Glucagonoma*, seen occasionally in MEN1, causes a syndrome of hyperglycemia, skin rash (necrolytic migratory erythema), anorexia, glossitis, anemia, depression, diarrhea, and venous thrombosis. In about half of these patients the plasma glucagon level is high, leading to its designation as the *glucagonoma syndrome*, although elevation of the plasma glucagon level in MEN1 patients is not necessarily associated with these symptoms. Some patients with this syndrome also have elevated plasma ghrelin levels. The glucagonoma syndrome may represent a complex interaction between glucagon and ghrelin overproduction and the nutritional status of the patient.

The *Verner-Morrison*, or *watery diarrhea, syndrome* consists of watery diarrhea, hypokalemia, hypochlorhydria, and metabolic acidosis. The diarrhea can be voluminous and is almost always found in association with an islet cell tumor, prompting use of the term *pancreatic cholera*.

However, the syndrome is not restricted to pancreatic islet tumors and has been observed with carcinoids or other tumors. This syndrome is believed to be due to overproduction of vasoactive intestinal peptide (VIP), although plasma VIP levels may not be elevated. Hypercalcemia may be induced by the effects of VIP on bone as well as by hyperparathyroidism. Other disorders that should be considered in the differential diagnosis of chronic diarrhea include infectious or parasitic diseases, inflammatory bowel disease, sprue, or other endocrine causes such as ZES, carcinoid, or medullary thyroid carcinoma.

The pancreatic neoplasms differ from the other components of MEN1 in that approximately a third of the tumors display malignant features, including hepatic metastases. The pancreatic neoplasms can also be used to highlight another characteristic of MEN1, the specific impact of a hormone produced by one component of MEN1 on another neoplastic component of this syndrome. Specific examples include the effects of either corticotropin-releasing hormone (CRH) or growth hormone-releasing hormone (GHRH) production by an islet cell tumor to cause a syndrome of excess adrenocorticotropin (ACTH) (Cushing's disease) or GH (acromegaly) production by the pituitary gland. These secondary interactions add complexity to the diagnosis and management of these tumor syndromes. Pancreatic islet cell tumors are diagnosed by identification of a characteristic clinical syndrome, hormonal assays with or without provocative stimuli, or radiographic techniques. One approach involves annual screening of individuals at risk with measurement of basal and meal-stimulated levels of pancreatic polypeptide to identify the tumors as early as possible; the rationale of this screening strategy is the concept that surgical removal of islet cell tumors at an early stage will be curative. Other approaches to screening include measurement of serum gastrin and pancreatic polypeptide levels every 2–3 years, with the rationale that pancreatic neoplasms will be detected at a later stage but can be managed medically, if possible, or by surgery. High-resolution, early-phase CT scanning or endoscopic ultrasound provides the best preoperative technique for identification of these tumors; intraoperative ultrasonography is the most sensitive method for detection of small tumors.

*Pituitary tumors* occur in 20–30% of patients with MEN1 and tend to be multicentric. These tumors can exhibit aggressive behavior and local invasiveness that makes them difficult to resect. Prolactinomas are most common (Fig. 47-1) and are diagnosed by finding serum prolactin levels  $>200$   $\mu\text{g/L}$ , with or without a pituitary mass evident by MRI. Values  $<200$   $\mu\text{g/L}$  may be due to a prolactin-secreting neoplasm or to compression of the pituitary stalk by a different type of pituitary tumor. Acromegaly due to excessive GH production is the second most common syndrome caused by pituitary tumors in MEN1 and can rarely be due to production



600 of GHRH by an islet cell tumor (see earlier). Cushing's disease can be caused by ACTH-producing pituitary tumors or by ectopic production of ACTH or CRH by other components of MEN1 syndrome including islet cell or carcinoid tumors or adrenal adenomas. Diagnosis of pituitary Cushing's disease is generally best accomplished by a high-dose dexamethasone suppression test or by petrosal venous sinus sampling for ACTH after IV injection of CRH. Differentiation of a primary pituitary tumor from an ectopic CRH-producing tumor may be difficult because the pituitary is the source of ACTH in both disorders; documentation of CRH production by a pancreatic islet or carcinoid tumor may be the only method of proving ectopic CRH production.


*Adrenal cortical tumors* are found in almost half of gene carriers but are rarely functional; malignancy in the cortical adenomas is uncommon. Rare cases of pheochromocytoma have been described in the context of MEN1. Due to its rarity, screening for these tumors is only indicated when there are suggestive symptoms.

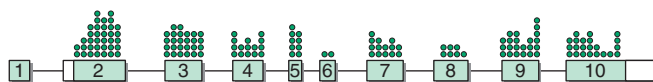
*Carcinoid tumors* in MEN1 are of the foregut type and are derived from thymus, lung, stomach, or duodenum; they may metastasize or be locally invasive. These tumors usually produce serotonin, calcitonin, or CRH; the typical carcinoid syndrome with flushing, diarrhea, and bronchospasm is rare (Chap. 46). Mediastinal carcinoid tumors (an upper mediastinal mass) are more common in men; bronchial carcinoid tumors are more common in women. Carcinoid tumors are a late manifestation of MEN1; some reports have emphasized the importance of routine chest CT screening for mediastinal carcinoid tumors because of their high rate of malignant transformation and aggressive behavior.

### Unusual Manifestations of MEN1

Subcutaneous or visceral lipomas and cutaneous leiomyomas may also be present but rarely undergo malignant transformation. Skin angiofibromas or collagenomas are seen in most patients with MEN1 when carefully sought.

## GENETIC CONSIDERATIONS

 *MEN1* gene mutations are found in >90% of families with the syndrome (Fig. 47-2). Genetic testing can be performed in individuals at risk for the development of MEN1 and is now commercially available in the United States and Europe. The major value of genetic testing in a kindred with an identifiable mutation is the assignment or exclusion of gene carrier status. In those identified as carrying the mutant gene, routine screening for individual manifestations of MEN1 should be performed as outlined earlier. Those with negative genetic test results in a kindred with a known germ-line mutation can be excluded from further screening for MEN1. A significant percentage of sporadic parathyroid, islet cell, and carcinoid tumors also



**FIGURE 47-2**  
**Schematic depiction of the *MEN1* gene and the distribution of mutations.** The shaded areas show coding sequence. The closed circles show the relative distribution of mutations, mostly inactivating, in each exon. Mutation data are derived from the Human Gene Mutation Database from which more detailed information can be obtained ([www.uwcm.ac.uk/uwcm/mg/hgmd0.html](http://www.uwcm.ac.uk/uwcm/mg/hgmd0.html)). (From M Krawczak, DN Cooper: *Trends Genet* 13:1321, 1998.)

have loss or mutation of *MEN1*. It is presumed that these mutations are somatic and occur in a single cell, leading to subsequent transformation.

### **Rx** Treatment: **MULTIPLE ENDOCRINE NEOPLASIA TYPE 1**

Almost everyone who inherits a mutant *MEN1* gene develops at least one clinical manifestation of the syndrome. Most develop hyperparathyroidism, 80% develop pancreatic islet cell tumors, and more than half develop pituitary tumors. For most of these tumors, initial surgery is not curative and patients frequently require multiple surgical procedures and surgery on two or more endocrine glands during a lifetime. For this reason, it is essential to establish clear goals for management of these patients rather than to recommend surgery casually each time a tumor is discovered. Ranges for acceptable management are discussed below.

**HYPERPARATHYROIDISM** Individuals with serum calcium levels >3.0 mmol/L (12 mg/dL), evidence of calcium nephrolithiasis or renal dysfunction, neuropathic or muscular symptoms, or bone involvement (including osteopenia) or individuals <50 years of age should undergo parathyroid exploration. There is less agreement regarding the necessity for parathyroid exploration in individuals who do not meet these criteria, and observation may be appropriate in the MEN1 patient with asymptomatic hyperparathyroidism.

When parathyroid surgery is indicated in MEN1, there are two approaches. In the first, all parathyroid tissue is identified and removed at the time of primary operation, and parathyroid tissue is implanted in the non-dominant forearm. Thymectomy should also be performed because of the potential for later development of malignant carcinoid tumors. If reoperation for hyperparathyroidism is necessary at a later date, transplanted parathyroid tissue can be resected from the forearm with titration of tissue removal to lower the intact parathyroid hormone (PTH) to <50% of basal.

Another approach is to remove 3–3.5 parathyroid glands from the neck (leaving ~50 mg of parathyroid tissue), carefully marking the location of residual tissue so that the remaining tissue can be located easily during subsequent surgery. If this approach is used, intraoperative PTH measurements should be utilized to monitor adequacy of removal of parathyroid tissue with a goal of reducing postoperative serum intact PTH to  $\leq 50\%$  of basal values.

The use of high-resolution CT scanning (1 mm) and imaging during three phases of contrast flow has substantially improved the ability to identify aberrantly located parathyroid tissue. As this issue arises with some frequency in the context of parathyroid disease in MEN1, this technique should be used to locate parathyroid tissue before reoperation for a failed exploration, and it may be useful prior to the initial operation.

**PANCREATIC ISLET CELL TUMORS** (See Chap. 46 for discussion of pancreatic islet cell tumors not associated with MEN1.) Two features of pancreatic islet cell tumors in MEN1 complicate the management. First, the pancreatic islet cell tumors are multicentric, malignant about a third of the time, and cause death in 10–20% of patients. Second, performance of a total pancreatectomy to prevent malignancy causes diabetes mellitus, a disease with significant long-term complications that include neuropathy, retinopathy, and nephropathy. These features make it difficult to formulate clear-cut guidelines, but some general concepts appear to be valid. (1) Islet cell tumors producing insulin, glucagon, VIP, GHRH, or CRH should be resected because medical therapy for the hormonal effects of these tumors are generally ineffective. (2) Gastrin-producing islet cell tumors that cause ZES are frequently multicentric. Recent experience suggests that a high percentage of ZES in MEN1 is caused by duodenal wall carcinoid tumors and that resection of these tumors improves the cure rate. Treatment with  $H_2$  receptor antagonists (cimetidine or ranitidine) or proton pump inhibitors (omeprazole, lansoprazole, esomeprazole, etc.) provides an alternative, and some think preferable, therapy to surgery for control of ulcer disease in patients with multicentric tumors or with hepatic metastases. (3) In families in which there is a high incidence of malignant islet cell tumors that cause death, total pancreatectomy at an early age may be considered to prevent malignancy.

Management of metastatic islet cell carcinoma is unsatisfactory. Hormonal abnormalities can sometimes be controlled. For example, ZES can be treated with  $H_2$  receptor antagonists or proton pump inhibitors; the somatostatin analogues, octreotide or lanreotide, are useful in the management of carcinoid, glucagonoma, and the watery diarrhea syndrome. Bilateral adrenalectomy may be required for ectopic ACTH syndrome if

medical therapy is ineffective. Islet cell carcinomas frequently metastasize to the liver but may grow slowly. Hepatic artery embolization, radiofrequency ablation, or chemotherapy (5-fluorouracil, streptozocin, chlorozotocin, doxorubicin, or dacarbazine) may reduce tumor mass, control symptoms of hormone excess, and prolong life; however, these treatments are never curative. Consideration should be given to participation in clinical trials of new agents that target specific molecular pathways.

**PITUITARY TUMORS** Treatment of prolactinomas with dopamine agonists (bromocriptine, cabergoline, or quinagolide) usually returns the serum prolactin level to normal and prevents further tumor growth. Surgical resection of a prolactinoma is rarely curative but may relieve mass effects. Transsphenoidal resection is appropriate for neoplasms that secrete ACTH, GH, or the  $\alpha$ -subunit of the pituitary glycoprotein hormones. Octreotide reduces tumor mass in a third of GH-secreting tumors and reduces GH and insulin-like growth factor I levels in >75% of patients. Pegvisomant, a GH antagonist, rapidly lowers insulin-like growth factor levels in patients with acromegaly. Radiation therapy may be useful for large or recurrent tumors.

Improvements in the management of MEN1, particularly the earlier recognition of islet cell and pituitary tumors, have improved outcomes in these patients. As a result, other neoplastic manifestations that develop later in the course of this disorder, such as carcinoid syndrome, are now seen with increased frequency.

## MULTIPLE ENDOCRINE NEOPLASIA TYPE 2

### *Clinical Manifestations*

Medullary thyroid carcinoma (MTC) and pheochromocytoma are associated in two major syndromes: MEN type 2A and MEN type 2B (Table 47-1). MEN2A is the combination of MTC, hyperparathyroidism, and pheochromocytoma. Three subvariants of MEN2A are familial medullary thyroid carcinoma (FMTC), MEN2A with cutaneous lichen amyloidosis, and MEN2A with Hirschsprung's disease. MEN2B is the combination of MTC, pheochromocytoma, mucosal neuromas, intestinal ganglioneuromatosis, and marfanoid features.

### Multiple Endocrine Neoplasia Type 2A

MTC is the most common manifestation. This tumor usually develops in childhood, beginning as hyperplasia of the calcitonin-producing cells (C cells) of the thyroid. MTC is typically located at the junction of the upper one-third and lower two-thirds of each lobe of the thyroid, reflecting the high density of C cells in this location; tumors >1 cm in size are frequently associated with local or distant metastases. Measurement of the

602 serum calcitonin level after calcium or pentagastrin injection makes it possible to diagnose this disorder at an early stage in its development (see later).

Pheochromocytoma occurs in ~50% of patients with MEN2A and causes palpitations, nervousness, headaches, and sometimes sweating (Chap. 48). About half of the tumors are bilateral, and >50% of patients who have had unilateral adrenalectomy develop a pheochromocytoma in the contralateral gland within a decade. A second feature of these tumors is a disproportionate increase in the secretion of epinephrine relative to norepinephrine. This characteristic differentiates the MEN2 pheochromocytomas from sporadic pheochromocytoma and those associated with von Hippel–Lindau (VHL) syndrome, hereditary paraganglioma, or neurofibromatosis. Capsular invasion is common, but metastasis is uncommon. Finally, the pheochromocytomas are almost always found in the adrenal gland, differentiating the pheochromocytomas in MEN2 from the extraadrenal tumors more commonly found in hereditary paraganglioma syndromes.

Hyperparathyroidism occurs in 15–20% of patients, with the peak incidence in the third or fourth decade. The manifestations of hyperparathyroidism do not differ from those in other forms of primary hyperparathyroidism. Diagnosis is established by finding hypercalcemia, hypophosphatemia, hypercalciuria, and an inappropriately high serum level of intact parathyroid hormone. Multiglandular parathyroid hyperplasia is the most common histologic finding, although with long-standing disease adenomatous changes may be superimposed on hyperplasia.

The most common subvariant of MEN2A is familial MTC, an autosomal dominant syndrome in which MTC is the only manifestation (Table 47-1). The clinical diagnosis of FMTC is established by the identification of MTC in multiple generations without a pheochromocytoma. Because the penetrance of pheochromocytoma is 50% in MEN2A, it is possible that MEN2A could masquerade as FMTC in small kindreds. It is important to consider this possibility carefully before classifying a kindred as having FMTC; failure to do so could lead to death or serious morbidity from pheochromocytoma in an affected kindred member. The difficulty of differentiating MEN2A and FMTC is discussed further later.

### Multiple Endocrine Neoplasia Type 2B

The association of MTC, pheochromocytoma, mucosal neuromas, and a marfanoid habitus is designated MEN2B. MTC in MEN2B develops earlier and is more aggressive than in MEN2A. Metastatic disease has been described prior to 1 year of age, and death may occur in the second or third decade of life. However, the prognosis is not invariably bad even in patients with metastatic disease, as evidenced by a number of multigenerational families with this disease.

Pheochromocytoma occurs in more than half of MEN2B patients and does not differ from that in MEN2A. Hypercalcemia is rare in MEN2B, and there are no well-documented examples of hyperparathyroidism.

The mucosal neuromas and marfanoid body habitus are the most distinctive features and are recognizable in childhood. Neuromas are present on the tip of the tongue, under the eyelids, and throughout the gastrointestinal tract and are true neuromas, distinct from neurofibromas. The most common presentation in children relates to gastrointestinal symptomatology including intermittent colic, pseudoobstruction, and diarrhea.

## GENETIC CONSIDERATIONS

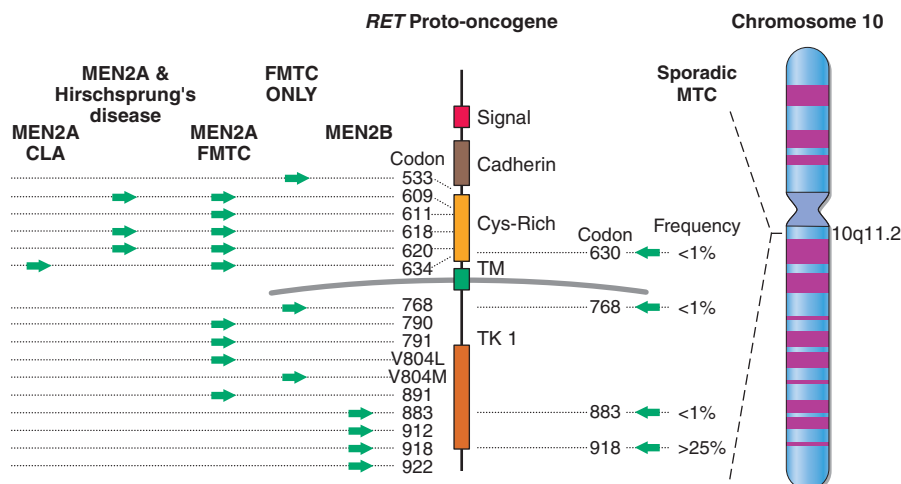


Mutations of the *RET* proto-oncogene have been identified in most patients with MEN2 (Fig. 47-3).

*RET* encodes a tyrosine kinase receptor, that in combination with a co-receptor, GFR $\alpha$ , is normally activated by glial cell-derived neurotrophic factor (GDNF) or other members of this transforming growth factor  $\beta$ -like family of peptides including artemin, persephin, and neurturin. In the C cell there is evidence that persephin normally activates the *RET*/GFR $\alpha$ -4 receptor complex and is partially responsible for migration of the C cells into the thyroid gland, whereas in the gastrointestinal tract, GDNF activates the *RET*/GFR $\alpha$ -1 complex. *RET* mutations induce constitutive activity of the receptor, explaining the autosomal dominant transmission of the disorder.

Naturally occurring mutations localize to two regions of the *RET* tyrosine kinase receptor. The first is a cysteine-rich extracellular domain; point mutations in the coding sequence for one of six cysteines (codons 609, 611, 618, 620, 630, or 634) cause amino acid substitutions that induce receptor dimerization and activation in the absence of its ligand. Codon 634 mutations occur in 80% of MEN2A kindreds and are most commonly associated with classic MEN2A features (Figs. 47-2 and 47-3); an arginine substitution at this codon accounts for half of all MEN2A mutations. All reported families with MEN2A and cutaneous lichen amyloidosis have a codon 634 mutation. Mutations of codons 609, 611, 618, or 620 occur in 10–15% of MEN2A kindreds and are more commonly associated with FMTC (Fig. 47-3). Mutations in codons 609, 618, and 620 have also been identified in a variant of MEN2A that includes Hirschsprung's disease (Fig. 47-3). The second region of the *RET* tyrosine kinase that is mutated in MEN2 is in the substrate recognition pocket at codon 918 (Fig. 47-3). This activating mutation is present in ~95% of patients with MEN2B and accounts for 5% of all *RET* proto-oncogene mutations in MEN2. Mutations of codon 883 and 922 have also been identified in a few patients with MEN2B.

Uncommon mutations (<5% of the total) include those of codons 533 (exon 8), 666, 768, 777, 790, 791,



**FIGURE 47-3**

**Schematic diagram of the *RET* proto-oncogene showing mutations found in MEN type 2 and sporadic medullary thyroid carcinoma (MTC).** The *RET* proto-oncogene is located on the proximal arm of chromosome 10q (10q11.2). Activating mutations of two functional domains of *RET* tyrosine kinase receptor have been identified. The first affects a cysteine-rich (Cys-Rich) region in the extracellular portion of the receptor. Each germ-line mutation changes a cysteine at codons 609, 611, 618, 620, or 634 to another amino acid. The second region is the intracellular tyrosine kinase (TK)

domain. Codon 634 mutations account for ~80% of all germ-line mutations. Mutations of codons 630, 768, 883, and 918 have been identified as somatic (non-germ-line) mutations that occur in a single parafollicular or C cell within the thyroid gland in sporadic MTC. A codon 918 mutation is the most common somatic mutation. MEN2, multiple endocrine neoplasia type 2; CLA, cutaneous lichen amyloidosis; FMTC, familial medullary thyroid carcinoma; Signal, the signal peptide; Cadherin, a cadherin-like region in the extracellular domain; TM, transmembrane domain; TK, tyrosine kinase domain.

804, 891, and 912. Mutations associated with only FMTC include codons 533, 768, and 912. With greater experience, mutations that were once associated with FMTC only (666, 791, V804L, V804M, and 891) have since been found in MEN2A because there have been occasional descriptions of pheochromocytoma. At present it is reasonable to conclude that only kindreds with codon 533, 768, or 912 mutations are consistently associated with FMTC; in kindreds with all other *RET* mutations, pheochromocytoma is a possibility. The recognition that germ-line mutations occur in at least 6% of patients with apparently sporadic MTC has led to the firm recommendation that all patients with MTC should be screened for these mutations. The effort to screen patients with sporadic MTC when combined with the fact that new kindreds with classic MEN2A are being recognized less frequently has led to a shift in the mutation frequencies. These findings mirror results in other malignancies where germ-line mutations of cancer-causing genes contribute to a greater percentage of apparently sporadic cancer than previously considered. The recognition of new *RET* mutations suggests that more will be identified in the future.

Somatic mutations (found only in the tumor and not transmitted in the germ line) of the *RET* proto-oncogene have been identified in sporadic MTC; 25–35% of

sporadic tumors have codon 918 mutations, and somatic mutations in codons 630, 768, and 804 have also been identified (Fig. 47-3).

**Treatment:**  
**Rx MULTIPLE ENDOCRINE NEOPLASIA TYPE 2**

**SCREENING FOR MULTIPLE ENDOCRINE NEOPLASIA TYPE 2** Death from MTC can be prevented by early thyroidectomy. The identification of *RET* proto-oncogene mutations and the application of DNA-based molecular diagnostic techniques to identify these mutations has simplified the screening process. During the initial evaluation of a kindred, a *RET* proto-oncogene analysis should be performed on an individual with proven MEN2A. Establishment of the specific germ-line mutation facilitates the subsequent analysis of other family members. Each family member at risk should be tested twice for the presence of the specific mutation; the second analysis should be performed on a new DNA sample and, ideally, in a second laboratory to exclude sample mix-up or technical error (see [www.genetests.org](http://www.genetests.org) for an up-to-date list of laboratory testing sites). Both false-positive

and false-negative analyses have been described; a false-negative test result is of the greatest concern because calcitonin testing is now rarely performed as a diagnostic backup study; if there is a genetic test error, a child may present in the second or third decade with metastatic MTC. Individuals in a kindred with a known mutation who have two normal analyses can be excluded from further screening.

There is general consensus that children with codon 883, 918, and 922 mutations, those associated with MEN2B, should have a total thyroidectomy and central lymph node dissection (level VI) performed during the first months of life or soon after identification of the syndrome. If local metastasis is discovered, a more extensive lymph node dissection (levels II to V) is generally indicated. In children with codon 611, 618, 620, 630, 634, and 891 mutations, thyroidectomy should be performed before the age of 6 years because of reports of local metastatic disease in children this age. Finally, there are kindreds with codon 609, 768, 790, 791, 804, and 912 mutations where the phenotype of MTC appears to be less aggressive. The clinician caring for children with one of these mutations faces a dilemma. In many kindreds there has never been a death from MTC caused by one of these mutations. However, in other kindreds there are examples of metastatic disease occurring early in life. For example, metastatic disease prior to the age of 6 years has been described with codon 609 and 804 mutations and before the age of 14 years in a patient with a codon 912 mutation. In kindreds with these mutations, two management approaches have been suggested: (1) perform a total thyroidectomy with or without central node dissection at some arbitrary age (perhaps 6–10 years of age), or (2) continue annual or biannual calcitonin provocative testing with performance of total thyroidectomy with or without central neck dissection when the test becomes abnormal. The pentagastrin test involves measurement of serum calcitonin basally and 2, 5, 10, and 15 min after a bolus injection of 5 µg pentagastrin per kilogram body weight. Patients should be warned before pentagastrin injection of epigastric tightness, nausea, warmth, and tingling of extremities and reassured that the symptoms will last ~2 min. If pentagastrin is unavailable, an alternative is a short calcium infusion, performed by obtaining a baseline serum calcitonin and then infusing 150 mg calcium salt IV over 10 min with measurement of serum calcitonin at 5, 10, 15, 30 min after initiation of the infusion.

The *RET* proto-oncogene analysis should be performed in patients with suspected MEN2B to detect codon 883, 918, and 922 mutations, especially in newborn children where the diagnosis is suspected but the clinical phenotype is not fully developed. Other family members at risk for MEN2B should also be tested because the mucosal neuromas can be subtle. Most

MEN2B mutations represent de novo mutations derived from the paternal allele. In the rare families with proven germ-line transmission of MTC but no identifiable *RET* proto-oncogene mutation (sequencing of the entire *RET* gene should be performed), annual pentagastrin or calcium testing should be performed on members at risk.

Annual screening for pheochromocytoma in patients with germ-line *RET* mutations should be performed by measuring basal plasma or 24-h urine catecholamines and metanephrines. The goal is to identify a pheochromocytoma before it causes significant symptoms or is likely to cause sudden death, an event most commonly associated with large tumors. Although there are kindreds with FMTC and specific *RET* mutations in which no pheochromocytomas have been identified (Fig. 47-3), clinical experience is insufficient to exclude pheochromocytoma screening in these individuals. Radiographic studies, such as MRI or CT scans, are generally reserved for individuals with abnormal screening tests or with symptoms suggestive of pheochromocytoma (Chap. 48). Women should be tested during pregnancy because undetected pheochromocytoma can cause maternal death during childbirth.

Measurement of serum calcium and parathyroid hormone levels every 2–3 years provides an adequate screen for hyperparathyroidism, except in those families in which hyperparathyroidism is a prominent component, where measurements should be made annually.

**MEDULLARY THYROID CARCINOMA** Hereditary MTC is a multicentric disorder. Total thyroidectomy with a central lymph node dissection should be performed in children who carry the mutant gene. Incomplete thyroidectomy leaves the possibility of later transformation of residual C cells. The goal of early therapy is cure, and a strategy that does not accomplish this goal is short-sighted. Long-term follow-up studies indicate an excellent outcome, with ~90% of children free of disease 15–20 years after surgery. In contrast, 15–25% of patients in whom the diagnosis is made on the basis of a palpable thyroid nodule die from the disease within 15–20 years.

In adults with MTC >1 cm in size, metastases to regional lymph nodes are common (>75%). Total thyroidectomy with central lymph node dissection and selective dissection of other regional chains provide the best chance for cure. In patients with extensive local metastatic disease in the neck, external radiation may prevent local recurrence or reduce tumor mass but is not curative. Chemotherapy with combinations of adriamycin, vincristine, cyclophosphamide, and dacarbazine may provide palliation. Clinical trials with small compounds that interact with the ATP-binding pocket of the RET receptor and prevent phosphorylation of tyrosine (tyrosine kinase inhibitors) have shown promise for

treatment of hereditary MTC. Some of these agents will be entering phase II and III trials and should be considered in patients with metastatic disease. Phase I and II studies of some of these agents have documented tumor regression and lowering of calcitonin and carcinoembryonic antigen in some patients.

**PHEOCHROMOCYTOMA** The long-term goal for management of pheochromocytoma is to prevent death and cardiovascular complications. Improvements in radiographic imaging of the adrenals make direct examination of the apparently normal contralateral gland during surgery less important, and the rapid evolution of laparoscopic abdominal or retroperitoneal surgery has simplified management of early pheochromocytoma. The major question is whether to remove both adrenal glands or to remove only the affected adrenal at the time of primary surgery. Issues to be considered in making this decision include the possibility of malignancy (<15 reported cases), the high probability of developing pheochromocytoma in the apparently unaffected gland over an 8- to 10-year period, and the risks of adrenal insufficiency caused by removal of both glands (at least two deaths related to adrenal insufficiency have occurred in MEN2 patients). Most clinicians recommend removing only the affected gland. If both adrenals are removed, glucocorticoid and mineralocorticoid replacement is mandatory. An alternative approach is to perform a cortical-sparing adrenalectomy, removing the pheochromocytoma and adrenal medulla, leaving the adrenal cortex behind. This approach is usually successful and eliminates the necessity for steroid hormone replacement in most patients, although the pheochromocytoma recurs in a small percentage.

**HYPERPARATHYROIDISM** Hyperparathyroidism has been managed by one of two approaches. Removal of 3.5 glands with maintenance of the remaining half gland in the neck is the usual procedure. In families in whom hyperparathyroidism is a prominent manifestation (almost always associated with a codon 634 *RET* mutation) and recurrence is common, total parathyroidectomy with transplantation of parathyroid tissue into the nondominant forearm is preferred. This approach was discussed earlier in the context of hyperparathyroidism associated with MEN 1.

## OTHER GENETIC ENDOCRINE TUMOR SYNDROMES

A number of mixed syndromes exist in which the neoplastic associations differ from those in MEN 1 or 2 (Table 47-1).

The cause of VHL syndrome, the association of central nervous system tumors, renal cell carcinoma,

pheochromocytoma, and islet cell neoplasms, is a mutation in the *VHL* tumor-suppressor gene. Germ-line-inactivating mutations of the *VHL* gene cause tumor formation when there is additional loss or somatic mutation of the normal *VHL* allele in brain, kidney, pancreatic islet, or adrenal medullary cells. Missense mutations been identified in >40% of VHL families with pheochromocytoma, suggesting that families with this type of mutation should be surveyed routinely for pheochromocytoma. A point that may be useful in differentiating VHL from MEN1 (overlapping features include islet cell tumor and rare pheochromocytoma) or MEN2 (overlapping feature is pheochromocytoma) is that hyperparathyroidism rarely occurs in VHL.

The molecular defect in type 1 neurofibromatosis inactivates neurofibromin, a cell membrane-associated protein that normally activates a GTPase. Inactivation of this protein impairs GTPase and causes continuous activation of p21 Ras and its downstream tyrosine kinase pathway. Endocrine tumors also form in less common neoplastic genetic syndromes. These include Cowden's disease, Carney's complex, familial acromegaly, and familial carcinoid syndrome. Carney's complex comprises myxomas of the heart, skin, and breast; peripheral nerve schwannomas; spotty skin pigmentation; and testicular, adrenal, and GH-secreting pituitary tumors. Linkage analysis has identified two loci: chromosome 2p in half of families and 17q in the others. The 17q gene has been identified as the regulatory subunit (type IA) of protein kinase A (*PRKA1A*).

## IMMUNOLOGIC SYNDROMES AFFECTING MULTIPLE ENDOCRINE ORGANS

When immune dysfunction affects two or more endocrine glands and other nonendocrine immune disorders are present, the *polyglandular autoimmune (PGA) syndromes* should be considered. The PGA syndromes are classified as two main types: the type I syndrome starts in childhood and is characterized by mucocutaneous candidiasis, hypoparathyroidism, and adrenal insufficiency; the type II, or Schmidt, syndrome is more likely to present in adults and most commonly comprises adrenal insufficiency, thyroiditis, or type 1 diabetes mellitus. Some authors have attempted to subdivide PGA II on the basis of association with some autoimmune disorders but not others (i.e., type II and type III). The type III syndrome is heterogeneous and may consist of autoimmune thyroid disease along with a variety of other autoimmune endocrine disorders (Table 47-2). However, little information is gained by making this subdivision in terms of understanding pathogenesis or prevention of future endocrine complications in individual patients or in the affected families.

**FEATURES OF POLYGLANDULAR AUTOIMMUNE (PGA) SYNDROMES**

PGA I	PGA II
<b>Epidemiology</b>	
Autosomal recessive Mutations in APECED gene	Polygenic inheritance HLA-DR3 and HLA-DR4 associated
Childhood onset Equal male-to-female ratio	Adult onset Female predominance
<b>Disease Associations</b>	
Mucocutaneous candidiasis Hypoparathyroidism Adrenal insufficiency Hypogonadism Alopecia Hypothyroidism Dental enamel hypoplasia Malabsorption Chronic active hepatitis Vitiligo Pernicious anemia	Adrenal insufficiency Hypothyroidism Graves' disease Type 1 diabetes Hypogonadism Hypophysitis Myasthenia gravis Vitiligo Alopecia Pernicious anemia Celiac disease

**Note:** APECED, autoimmune polyendocrinopathy-candidiasis-ectodermal dystrophy.

**POLYGLANDULAR AUTOIMMUNE SYNDROME TYPE I**

PGA type I is usually recognized in the first decade of life and requires two of three components for diagnosis: mucocutaneous candidiasis, hypoparathyroidism, and adrenal insufficiency. Mucocutaneous candidiasis and hypoparathyroidism present with similar high frequency (100% and 79–96%, respectively). Adrenal insufficiency is observed in 60–72% of patients. Mineralocorticoids and glucocorticoids may be lost simultaneously or sequentially. PGA type 1 is also called *autoimmune polyendocrinopathy-candidiasis-ectodermal dystrophy* (APECED). Other endocrine defects can include gonadal failure (60% female, 14% male), hypothyroidism (5%), and destruction of the beta cells of the pancreatic islets and development of insulin-dependent (type 1) diabetes mellitus (14% lifetime risk). Additional features include hypoplasia of the dental enamel, nail dystrophy, tympanic membrane sclerosis, vitiligo, keratopathy, and gastric parietal cell dysfunction resulting in pernicious anemia (13%). Some patients develop autoimmune hepatitis (12%), malabsorption (variably attributed to intestinal lymphangiectasia, bacterial overgrowth, or hypoparathyroidism), asplenism, achalasia, and cholelithiasis (Table 47-2). At the outset, only one organ may be involved, but the number increases with time so that patients eventually manifest two to five components of the syndrome.

Most patients initially present with oral candidiasis in childhood; it is poorly responsive to treatment and relapses frequently. Chronic hypoparathyroidism usually occurs before adrenal insufficiency develops. More than 60% of postpubertal women develop premature hypogonadism. The endocrine components, including adrenal insufficiency and hypoparathyroidism, may not develop until the fourth decade, making continued surveillance necessary.

Type I PGA syndrome is not associated with a particular HLA type and is usually inherited as an autosomal recessive trait. It may occur sporadically. The responsible gene, designated as either *APECED* or *AIRE*, encodes a transcription factor that is expressed in thymus and lymph nodes; a variety of different mutations have been reported. The mechanism by which these mutations lead to the diverse manifestations of type I PGA is still unknown.

**POLYGLANDULAR AUTOIMMUNE SYNDROME TYPE II**

PGA type II is characterized by two or more of the endocrinopathies listed in Table 47-2. Most often these include primary adrenal insufficiency, Graves' disease or autoimmune hypothyroidism, type 1 diabetes mellitus, or primary hypogonadism. Because adrenal insufficiency is relatively rare, it is frequently used to define the presence of the syndrome. Among patients with adrenal insufficiency, type 1 diabetes mellitus coexists in 52% and autoimmune thyroid disease occurs in 69%. However, many patients with antimicrobial and antithyroglobulin antibodies never develop abnormalities of thyroid function. Thus increased antibody titers alone are poor predictors of future disease. Other associated conditions include hypophysitis, celiac disease (2–3%), atrophic gastritis, and pernicious anemia (13%). Vitiligo, caused by antibodies against the melanocyte, and alopecia are less common than in the type I syndrome. Mucocutaneous candidiasis does not occur. A few patients develop a late-onset, usually transient hypoparathyroidism caused by antibodies that compete with parathyroid hormone for binding to the parathyroid hormone receptor. Up to 25% of patients with myasthenia gravis, and an even higher percentage who have myasthenia and a thymoma, have PGA type II.

The type II syndrome is familial in nature, often transmitted as an autosomal dominant trait with incomplete penetrance. Like many of the individual autoimmune endocrinopathies, certain HLA-DR3 and -DR4 alleles increase disease susceptibility; several different genes probably contribute to the expression of this syndrome.

A variety of autoantibodies are seen in PGA type II, including antibodies directed against: (1) thyroid antigens such as thyroid peroxidase, thyroglobulin, or the thyroid-stimulating hormone (TSH) receptor; (2) adrenal side

chain cleavage enzyme, steroid 21-hydroxylase, or ACTH receptor; and (3) pancreatic islet glutamic acid decarboxylase or the insulin receptor, among others. The roles of cytokines such as interferon and cell-mediated immunity are unclear.

## DIAGNOSIS

The clinical manifestations of adrenal insufficiency often develop slowly, may be difficult to detect, and can be fatal if not diagnosed and treated appropriately. Thus prospective screening should be performed routinely in all patients and family members at risk for PGA types I and II. The most effective screening test for adrenal disease is a cosyntropin stimulation test. A fasting blood glucose level can be obtained to screen for hyperglycemia. Additional screening tests should include measurements of TSH, luteinizing hormone, follicle-stimulating hormone, and, in men, testosterone levels. In families with suspected type I PGA syndrome, calcium and phosphorus levels should be measured. These screening studies should be performed every 1–2 years up to ~50 years of age in families with PGA type II syndrome and until ~40 years of age in patients with type I syndrome. Screening measurements of autoantibodies against potentially affected endocrine organs are of uncertain prognostic value. The differential diagnosis of PGA syndrome should include the DiGeorge syndrome (hypoparathyroidism due to glandular agenesis and mucocutaneous candidiasis), Kearns-Sayre syndrome (hypoparathyroidism, primary hypogonadism, type 1 diabetes mellitus, and panhypopituitarism), Wolfram's syndrome (congenital diabetes insipidus and diabetes mellitus), IPEX syndrome (immunodysregulation, polyendocrinopathy, and enteropathy, X-linked), and congenital rubella (type 1 diabetes mellitus and hypothyroidism).

### **Rx** Treatment: **POLYGLANDULAR AUTOIMMUNE SYNDROME**

With the exception of Graves' disease, the management of each of the endocrine components of the disease involves hormone replacement and is covered in detail in the chapter on thyroid disease (Chap. 45). Some aspects of therapy deserve special emphasis. Primary hypothyroidism can mask adrenal insufficiency by prolonging the half-life of cortisol; consequently, administration of thyroid hormone to a patient with unsuspected adrenal insufficiency can precipitate adrenal crisis. Thus all patients with hypothyroidism in the context of PGA syndrome should be screened for adrenal disease and, if it is present, be treated with glucocorticoids prior to or concurrently with thyroid hormone therapy. Hypoglycemia or decreasing insulin

requirements in a patient with diabetes mellitus type 1 may be the earliest symptom of adrenal insufficiency. Consequently, such patients should be screened for adrenal disease. Treatment of mucocutaneous candidiasis with ketoconazole may induce adrenal insufficiency. This drug may also elevate liver enzymes, making the diagnosis of autoimmune hepatitis more difficult. Hypocalcemia in PGA type II is more commonly due to malabsorption associated with celiac disease than to hypoparathyroidism.

## OTHER AUTOIMMUNE ENDOCRINE SYNDROMES

### *Insulin Resistance Caused by Antibodies*

Rare insulin-resistance syndromes occur in patients who develop antibodies that block the interaction of insulin with its receptor. Conversely, other classes of anti-insulin receptor antibodies can activate the receptor and can cause hypoglycemia; this disorder should be considered in the differential diagnosis of fasting hypoglycemia.

Patients with insulin receptor antibodies and acanthosis nigricans are often middle-aged women who acquire insulin resistance in association with other autoimmune disorders such as systemic lupus erythematosus or Sjögren's syndrome. Vitiligo, alopecia, Raynaud's phenomenon, and arthritis may also be seen. Other autoimmune endocrine disorders, including thyrotoxicosis, hypothyroidism, and hypogonadism, occur rarely. Acanthosis nigricans, a velvety, hyperpigmented, thickened skin lesion, is prominent on the dorsum of the neck and other skin fold areas in the axillae or groin and often heralds the diagnosis in these patients. However, acanthosis nigricans also occurs in patients with obesity or polycystic ovarian syndrome, in which insulin resistance appears to be due to a postreceptor defect; thus acanthosis nigricans itself is not diagnostic of the immunologic form of insulin resistance.

Some patients with acanthosis nigricans have mild glucose intolerance, with a compensatory increase in insulin secretion that is only detected when insulin levels are measured. Others have severe diabetes mellitus requiring massive doses of insulin (several thousand units per day) to lower the blood glucose levels. The nature of the antibodies determines the manifestations; although insulin resistance is more common, fasting hypoglycemia can result from insulinomimetic antibodies.

Insulin-resistant diabetes mellitus associated with anti-insulin antibodies occurs in patients with ataxia telangiectasia. This is an autosomal recessive disorder caused by mutations in *ATM*, a gene involved in cellular responses to ionizing radiation and oxidative damage. This disorder is characterized by ataxia, telangiectasia, immune abnormalities, and an increased incidence of malignancies.



This disorder typically occurs in patients with other autoimmune disorders and is caused by polyclonal autoantibodies that bind to endogenously synthesized insulin. If the insulin dissociates from the antibodies several hours or more after a meal, hypoglycemia can result. Most cases of the syndrome have been described from Japan, and there may be a genetic component. In plasma cell dyscrasias such as multiple myeloma, the plasma cells may produce monoclonal antibodies against insulin and cause hypoglycemia by a similar mechanism.

### **Antithyroxine Antibodies and Hypothyroidism**

Circulating autoantibodies against thyroid hormones in patients with both immune thyroid disease and plasma cell dyscrasias such as Waldenström's macroglobulinemia can bind thyroid hormones, decrease their biologic activity, and result in primary hypothyroidism. In other patients, the antibodies simply interfere with thyroid hormone immunoassays and cause false elevations or decreases in measured hormone levels.

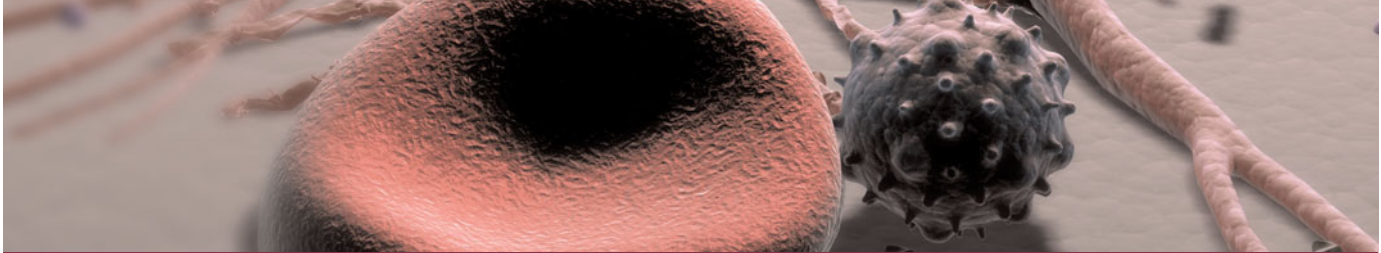
### **Crow-Fukase Syndrome**

The features of this syndrome are highlighted by an acronym that emphasizes its important features: *polyneuropathy, organomegaly, endocrinopathy, M-proteins, and skin changes (POEMS)*. The most important feature is a severe, progressive sensorimotor polyneuropathy associated with a plasma cell dyscrasia. Localized collections of plasma cells (plasmacytomas) can cause sclerotic bone lesions and produce monoclonal IgG or IgA proteins. Endocrine manifestations in men or women include hyperprolactinemia, diabetes mellitus type 2, primary hypothyroidism, and adrenal insufficiency. Additional findings include ovarian failure and amenorrhea in women and testicular failure, impotence, and gynecomastia in men. Skin changes include hyperpigmentation, thickening of the dermis, hirsutism, and hyperhidrosis. Hepatomegaly and lymphadenopathy occur in about two-thirds of patients, and splenomegaly is seen in about one-third. Other manifestations include increased cerebrospinal fluid pressure with papilledema, peripheral edema, ascites, pleural effusions, glomerulonephritis, and fever. Median survival may be >10 years, although shorter in patients with extravascular volume overload or clubbing.

The systemic nature of the disorder may cause confusion with other connective tissue diseases. The endocrine manifestations suggest an autoimmune basis of the disorder, but circulating antibodies against endocrine cells have not been demonstrated. Increased serum and tissue levels of interleukin 6, interleukin 1 $\beta$ , vascular endothelial growth factor, matrix metalloproteins, and tumor necrosis factor  $\alpha$  are present, but the pathophysiologic basis for the POEMS syndrome is uncertain. Therapy directed against the plasma cell dyscrasia such as local radiation of bony lesions, chemotherapy, thalidomide, plasmapheresis, bone marrow or stem cell transplantation, and treatment with all-*trans* retinoic acid may improve the endocrine manifestations.

### **FURTHER READINGS**

- ASARI R et al: Estimated risk of pheochromocytoma recurrence after adrenal-sparing surgery in patients with multiple endocrine neoplasia type 2A. *Arch Surg* 141:1199, 2006
- BOEDEKER CC et al: Head and neck paragangliomas in von Hippel-Lindau disease and multiple endocrine neoplasia type 2. *J Clin Endocrinol Metab* 94:1938, 2009
- CLARKE JT: Narrative review: Fabry disease. *Ann Intern Med* 146:425, 2007
- DALY AF et al: Update on familial pituitary tumors: From multiple endocrine neoplasia type 1 to familial isolated pituitary adenoma. *Horm Res* 71 (Suppl 1):105, 2009
- DEGROOT JW et al: RET as a diagnostic and therapeutic target in sporadic and hereditary endocrine tumors. *Endocr Rev* 27:535, 2006
- DITTMAR M et al: Polyglandular autoimmune syndromes: Immunogenetics and long-term follow-up. *J Clin Endocrinol Metab* 88:2983, 2003
- LINHART A, ELLIOTT PM: The heart in Anderson-Fabry disease and other lysosomal storage disorders. *Heart* 93:528, 2007
- NAKAMURA E, KAELIN WG JR: Recent insights into the molecular pathogenesis of pheochromocytoma and paraganglioma. *Endocr Pathol* 17:97, 2006
- NEUMANN HP, ENG C: The approach to the patient with paraganglioma. *J Clin Endocrinol Metab* 94:2677, 2009
- OZAWA A et al: The parathyroid/pituitary variant of men1 usually has causes other than p27kip1 mutations. *J Clin Endocrinol Metab* 92:1948, 2007
- PELLEGATA NS et al: Germ-line mutations in p27Kip1 cause a multiple endocrine neoplasia syndrome in rats and humans. *Proc Natl Acad Sci USA* 103:15558, 2006
- PLAZA-MENACHO I et al: Current concepts in RET-related genetics, signaling and therapeutics. *Trends Genet* 22:627, 2006
- RAUE F, FRANK-RAUE K: Genotype-phenotype relationship in multiple endocrine neoplasia type 2. *Hormones* 8:23, 2009
- SEVIN M et al: The adult form of Niemann-Pick disease type C. *Brain* 130:120, 2007
- YE L et al: Targeted therapy for endocrine cancer: The medullary thyroid carcinoma paradigm. *Endocr Prac* 22:1, 2009



## CHAPTER 48

# PHEOCHROMOCYTOMA AND ADRENOCORTICAL CARCINOMA

Hartmut P. H. Neumann ■ Dan L. Longo

Epidemiology . . . . .	.609	■ Adrenocortical Tumors . . . . .	.615
Etiology and Pathogenesis . . . . .	.609	Incidence and Etiology . . . . .	.615
Clinical Features . . . . .	.610	Genetic Considerations . . . . .	.617
Diagnosis . . . . .	.610	Clinical Features . . . . .	.617
Malignant Pheochromocytoma . . . . .	.612	Diagnostic Approach . . . . .	.617
Pheochromocytoma in Pregnancy . . . . .	.612	Staging . . . . .	.618
Pheochromocytoma-Associated Syndromes . . . . .	.612	■ Further Readings . . . . .	.619
Guidelines for Genetic Screening in Patients with Pheochromocytoma or Paraganglioma . . . . .	.614		

Pheochromocytomas and paragangliomas are catecholamine-producing tumors derived from the sympathetic or parasympathetic nervous system. These tumors may arise sporadically or be inherited as features of multiple endocrine neoplasia type 2 or several other pheochromocytoma-associated syndromes. The diagnosis of pheochromocytomas provides a potentially correctable cause of hypertension, and their removal can prevent hypertensive crises that can be lethal. The clinical presentation is variable, ranging from an adrenal incidentaloma to a patient in hypertensive crisis with associated cerebrovascular or cardiac complications.

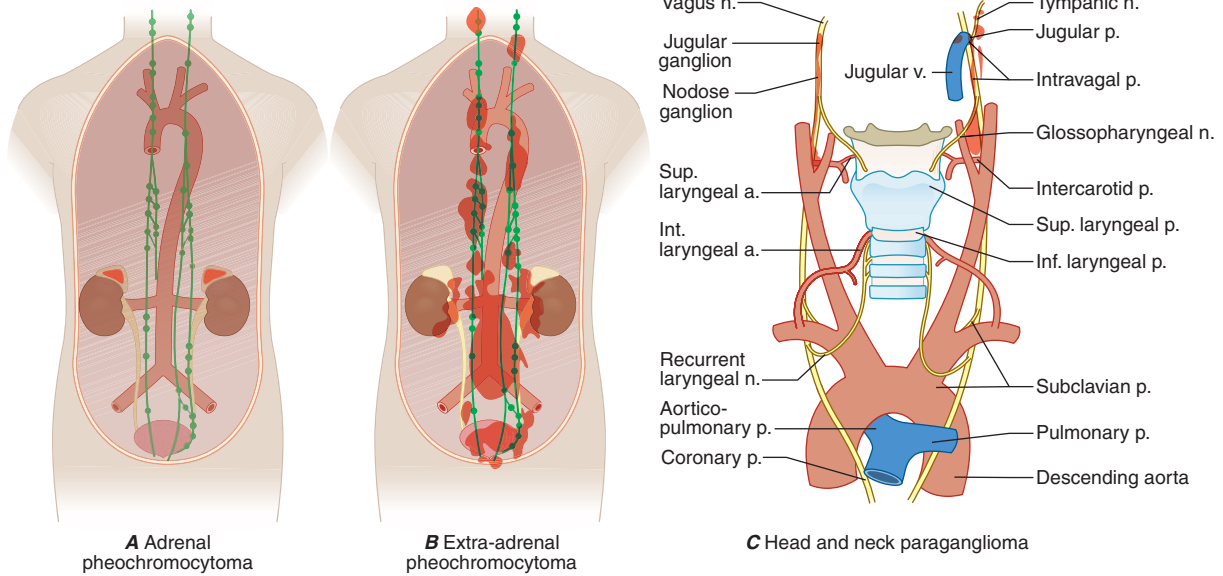
### EPIDEMIOLOGY

Pheochromocytoma is estimated to occur in 2–8 of 1 million persons per year, and ~0.1% of hypertensive patients harbor a pheochromocytoma. Autopsy series reveal prevalence figures of 0.2%. The mean age at diagnosis is ~40 years, although the tumors can occur from early childhood until late in life. The “rule of tens” for pheochromocytomas states that ~10% are bilateral, 10% are extraadrenal, and 10% are malignant. However, these percentages are higher in the inherited syndromes.

### ETIOLOGY AND PATHOGENESIS

Pheochromocytomas and paragangliomas are well-vascularized tumors that arise from cells derived from the sympathetic (e.g., adrenal medulla) or parasympathetic (e.g., carotid body, glomus vagale) paraganglia (Fig. 48-1). The name *pheochromocytoma* reflects the black-colored staining caused by chromaffin oxidation of catecholamines. Although a variety of nomenclatures have been used to describe these tumors, most clinicians use the term *pheochromocytoma* to describe symptomatic catecholamine-producing tumors, including those located in extraadrenal retroperitoneal, pelvic, and thoracic sites. The term *paraganglioma* is used to describe catecholamine-producing tumors in the head and neck, as well as tumors that arise from the parasympathetic nervous system, which may secrete little or no catecholamines.

The etiology of most sporadic pheochromocytomas and paragangliomas is unknown. However, ~25% of patients have an inherited condition, including germline mutations in the *RET*, *VHL*, *NF1*, *SDHB*, *SDHC*, or *SDHD* genes. Biallelic gene inactivation has been demonstrated for the *VHL*, *NF1*, and *SDH* genes, whereas *RET* mutations activate the receptor tyrosine kinase activity. *SDH* is an enzyme of the Krebs cycle



**FIGURE 48-1** The paraganglionic system and topographic sites (in red) of pheochromocytomas and paragangliomas. [A, B, from WM Manger, RW Gifford, *Clinical and Experimental Pheochromocytoma*. Cambridge, Blackwell Science, 1996 and C, from GG Glenner, PM Grimley, *Tumors of the Extra-Adrenal Paraganglion System (Including Chemoreceptors)*, *Atlas of Tumor Pathology*, 2d series, fascicle 9. Washington, DC, AFIP, 1974.]

and the mitochondrial respiratory chain. The VHL protein is a component of a ubiquitin E3 ligase. *VHL* mutations reduce protein degradation, resulting in upregulation of components involved in cell cycle progression, glucose metabolism, and oxygen sensing.

## CLINICAL FEATURES

The clinical presentation is so variable that pheochromocytoma has been termed “the great masquerader” (Table 48-1). Among the presenting symptoms, episodes of palpitations, headaches, and profuse sweating are typical and constitute a classic triad. The presence of all the three symptoms, in association with hypertension, makes pheochromocytoma a likely diagnosis. However, a pheochromocytoma can be asymptomatic for years, and

**TABLE 48-1**

CLINICAL FEATURES ASSOCIATED WITH PHEOCHROMOCYTOMA	
Headaches	Weight loss
Sweating attacks	Paradoxical response to antihypertensive drugs
Palpitation and tachycardia	Polyuria and polydipsia
Hypertension, sustained or paroxysmal	Constipation
Anxiety and panic attacks	Orthostatic hypotension
Pallor	Dilated cardiomyopathy
Nausea	Erythrocytosis
Abdominal pain	Elevated blood sugar
Weakness	Hypercalcemia

some tumors have grown to a considerable size before patients noted symptoms.

The dominant sign is hypertension. Classically, patients have episodic hypertension, but sustained hypertension is also frequent. Catecholamine crises can lead to heart failure, pulmonary edema, arrhythmias, and intracranial hemorrhage. During episodes of hormone release, which can occur at very divergent intervals, patients are anxious and pale, and they experience tachycardia and palpitations. These paroxysms generally last less than an hour and may be precipitated by surgery, positional changes, exercise, pregnancy, urination (particularly bladder pheochromocytomas), and various medications (e.g., tricyclic antidepressants, opiates, metoclopramide).

## DIAGNOSIS

The diagnosis is based on documentation of catecholamine excess by biochemical testing and localization of the tumor by imaging. Both are of equal importance, although measurement of catecholamines is traditionally the first step.

### Biochemical Testing

Pheochromocytomas and paragangliomas synthesize and store catecholamines, which include norepinephrine (norepinephrine), epinephrine (adrenaline), and dopamine. Elevated plasma and urinary levels of catecholamines and the methylated metabolites, metanephrines, are the cornerstone for

the diagnosis. The hormonal activity of tumors fluctuates, resulting in considerable variation in serial catecholamine measurements. Thus there is some value in obtaining tests during or soon after a symptomatic crisis. However, most tumors continuously leak O-methylated metabolites, which are detected by metanephrine measurements.

Catecholamines and metanephrines can be measured using many different methods (e.g., high-performance liquid chromatography, enzyme-linked immunosorbent assay, other immunoassays). In a clinical context suspicious for pheochromocytoma, when values are increased two to three times the upper limit of normal, a pheochromocytoma is highly likely, regardless of the assay used, assuming an appropriate clinical context. However, as summarized in **Table 48-2**, the sensitivity and specificity of available biochemical tests varies greatly, and these differences are important when assessing patients with borderline catecholamine elevation. Urinary tests for VMA, metanephrines (total or fractionated), and catecholamines are widely available and commonly used for initial testing. Among these tests, the fractionated metanephrines and catecholamines are the most sensitive. Plasma tests are more convenient and include measurements of catecholamines, metanephrines, and chromogranin A, a secretory product of endocrine cells. Plasma metanephrine measurements are most sensitive and are less susceptible to false-positive elevations from stress, including venipuncture. Although the incidence of false-positive test results has been reduced by the introduction of newer assays, physiologic stress

responses and medications (e.g., levodopa, labetalol, sympathomimetics) that increase catecholamines can still confound testing. Because the tumors are relatively rare, borderline elevations are likely to be false positives. In this circumstance, repeated testing, often using different assays, may clarify the diagnosis. If possible, physiologic (e.g., heart failure, shock, hypertension) or pharmacologic (clonidine withdrawal, tricyclic antidepressants) factors that might cause false positives should be eliminated. The pattern of catecholamines can help in localizing the tumor because epinephrine is virtually never increased in extraadrenal pheochromocytomas.

Pharmacologic tests, such as the phentolamine test, the glucagon provocation test, and the clonidine suppression test, are of relatively low sensitivity and are rarely used.

### Diagnostic Imaging

A variety of methods have been used to localize pheochromocytomas and paragangliomas (Table 48-2). CT and MRI are similar in sensitivity. CT should be performed with contrast. T2-weighted MRI with gadolinium contrast is optimal for detecting pheochromocytomas and somewhat better than CT for imaging extraadrenal pheochromocytomas and paragangliomas. About 5% of adrenal incidentalomas, usually detected by CT or MRI, prove to be pheochromocytomas after endocrinologic evaluation.

Tumors can also be localized using radioactive tracers including <sup>131</sup>I- or <sup>123</sup>I-metaiodobenzylguanidine (MIBG), <sup>111</sup>In-somatostatin analogues, or <sup>18</sup>F-dopa (or dopamine) positron-emission tomography (PET). Because these agents exhibit selective uptake in paragangliomas, nuclear imaging is particularly useful in the hereditary syndromes.

### Differential Diagnosis

When entertaining the possibility of a pheochromocytoma, other disorders to consider include essential hypertension, anxiety attacks, use of cocaine or amphetamines, mastocytosis or carcinoid syndrome (usually lacking hypertension), intracranial lesions, clonidine withdrawal, autonomic epilepsy, and factitious crises (usually from sympathomimetic amines). When an asymptomatic adrenal mass is identified, likely diagnoses other than pheochromocytoma include a nonfunctioning adrenal adenoma, aldosteronoma, and cortisol-producing adenoma (Cushing's syndrome).

### **Rx** Treatment: PHEOCHROMOCYTOMA

Complete tumor removal is the ultimate therapeutic goal. Preoperative patient preparation is essential for safe surgery.  $\alpha$ -Adrenergic blockers (phenoxybenzamine)

**TABLE 48-2**

#### BIOCHEMICAL AND IMAGING METHODS USED FOR PHEOCHROMOCYTOMA AND PARAGANGLIOMA DIAGNOSIS

DIAGNOSTIC METHOD	SENSITIVITY	SPECIFICITY
24-h urinary tests		
Vanillylmandelic acid	++	++++
Catecholamines	+++	+++
Fractionated metanephrines	++++	++
Total metanephrines	+++	++++
Plasma tests		
Catecholamines	+++	++
Free metanephrines	++++	+++
Chromogranin A	+++	++
CT	++++	+++
MRI	++++	+++
MIBG scintigraphy	+++	++++
Somatostatin receptor scintigraphy <sup>a</sup>	++	++
Dopa (dopamine) PET (preliminary data)	++++	++++

<sup>a</sup>Particularly high in head and neck paragangliomas.

**Note:** MIBG, metaiodobenzylguanidine; PET, positron-emission tomography.

should be initiated at relatively low doses (e.g., 5–10 mg orally three times per day) and increased as tolerated every few days. Because patients are volume constricted, liberal salt intake and hydration are necessary to avoid orthostasis. Adequate alpha blockade generally requires 10–14 days, with a typical final dose of 20–30 mg phenoxybenzamine three times per day. Oral prazosin or intravenous phentolamine can be used to manage paroxysms while awaiting adequate alpha blockade. Before surgery, the blood pressure should be consistently below 160/90 mm Hg, with moderate orthostasis. Beta-blockers (e.g., 10 mg propranolol three to four times per day) can be added after starting alpha-blockers, and increased as needed, if tachycardia persists. Because beta-blockers can induce a paradoxical increase in blood pressure in the absence of alpha blockade, they should be administered only after effective alpha blockade. Other antihypertensives, such as calcium-channel blockers or angiotensin-converting enzyme inhibitors, have also been used when blood pressure is difficult to control with phenoxybenzamine alone.

Surgery should be performed by teams of anesthesiologists and surgeons with experience in the management of pheochromocytomas. Blood pressure can be labile during surgery, particularly at the onset of intubation or when manipulating the tumor. Nitroprusside infusion is useful for intraoperative hypertensive crises, and hypotension usually responds to volume infusion. Although laparotomy was the traditional surgical approach, laparoscopy, using either a transperitoneal or retroperitoneal (for bilateral adrenalectomy) approach, is associated with fewer complications and a faster recovery. Atraumatic endoscopic surgery was introduced in the early 1990s and has now become the method of choice. It may be possible to preserve the normal adrenal cortex, particularly in hereditary disorders in which bilateral pheochromocytomas are more likely. Extraadrenal abdominal pheochromocytomas can also be removed endoscopically. Postoperatively, catecholamine normalization should be documented. An adrenocorticotrophic hormone test should be used to exclude cortisol deficiency when bilateral adrenal cortex-sparing surgery is performed.

## MALIGNANT PHEOCHROMOCYTOMA

About 5–10% of pheochromocytomas and paragangliomas are malignant. The diagnosis of malignant pheochromocytoma is problematic. Typical histologic criteria of cellular atypia, presence of mitoses, and invasion of vessels or adjacent tissues do not reliably identify which tumors have the capacity to metastasize. Thus the term *malignant pheochromocytoma* is generally restricted to tumors with distant metastases, most commonly found in lungs, bone, or liver, suggesting a vascular pathway of

spread. Because hereditary syndromes are associated with multifocal tumor sites, these features should be anticipated in patients with germ-line mutations of *RET*, *VHL*, *SDHD*, or *SDHB*. However, distant metastases also occur in these syndromes, especially carriers of *SDHB* mutations.

Treatment of malignant pheochromocytoma or paraganglioma is challenging. Options include tumor mass reduction; alpha-blockers for symptoms; chemotherapy; and nuclear medicine radiotherapy. Averbuch's chemotherapy protocol includes dacarbazine (600 mg/m<sup>2</sup> days 1 and 2), cyclophosphamide (750 mg/m<sup>2</sup> day 1), and vincristine (1.4 mg/m<sup>2</sup> day 1), repeated every 21 days for three to six cycles. Palliation (stable disease to shrinkage) is achieved in about half of patients. An alternative is <sup>131</sup>I-MIBG treatment using 200-mCi doses at monthly intervals, over three to six cycles. The prognosis of metastatic pheochromocytoma or paraganglioma is variable, with a 5-year survival of 30–60%.

## PHEOCHROMOCYTOMA IN PREGNANCY

Pheochromocytomas are occasionally diagnosed in pregnancy. Endoscopic removal, preferably in the fourth to sixth month of gestation, is possible and can be followed by uneventful childbirth. Regular screening in families with inherited pheochromocytomas provides an opportunity to identify and remove asymptomatic tumors in women of reproductive age.

## PHEOCHROMOCYTOMA-ASSOCIATED SYNDROMES

About 25–33% of patients with pheochromocytoma or paraganglioma have an inherited syndrome (**Table 48-3**). The mean age at diagnosis is ~15 years lower in patients with inherited syndromes compared to those with sporadic tumors.

*Neurofibromatosis type 1 (NF 1)* was the first described pheochromocytoma-associated syndrome (Chap. 43). The *NF1* gene functions as a tumor suppressor by regulating the ras signaling cascade. Classic features of neurofibromatosis include multiple neurofibromas, café au lait spots, axillary freckling of the skin, and Lisch nodules of the iris (**Fig. 48-2**). Pheochromocytomas occur in only ~1% of these patients and are located predominantly in the adrenals. Malignant pheochromocytoma is not infrequent.

The most well-known pheochromocytoma-associated syndrome is the autosomal dominant disorder *multiple endocrine neoplasia type 2A and type 2B (MEN2A, MEN2B)* (Chap. 47). Both types of MEN2 are caused by mutations in *RET* (rearranged in transfection), which encodes a tyrosine kinase. The locations of *RET* mutations correlate with the severity of disease and the type of MEN2 (Chap. 47). MEN2A is characterized by

TABLE 48-3

	MEN2	VHL	PGL4	PGL3	PGL1	NF 1
Mean age at diagnosis	34	16	34	41	26	43
Multifocal	65%	55%	12%	11%	48%	20%
Adrenal/abdominal extraadrenal	97%/3%	92%/17%	42%/58%	0	86%/57%	94%/6%
Thoracic	0	5%	12%	0	29%	0
Head and neck paraganglioma	0	0	6%	100%	48%	0
Malignancy	3%	4%	24%	0	0	12%
Associated tumors	Medullary thyroid carcinoma, primary hyperparathyroidism	Eye hemangiomas, hemangioblastomas of the CNS, clear cell renal carcinoma, pancreatic islet cell tumors, endolymphatic sac tumors of the inner ear	Renal cell carcinoma in a minority	No regular association with other tumors		Neurofibromas, café au lait spots, axillary freckling, optic pathway tumors, iris hamartomas
Inheritance	Autosomal dominant	Autosomal dominant	Autosomal dominant	Autosomal dominant, no manifestation in offspring of mothers	Autosomal dominant	Autosomal dominant
Gene name	<i>RET</i>	<i>VHL</i>	<i>SDHB</i>	<i>SDHC</i>	<i>SDHD</i>	<i>NF1</i>
Gene location	10q11.2	3p25–26	1p36	1q23	11q23	17q11.2
No. of exons	21	3	8	6	4	57

**Note:** CNS, central nervous system; MEN2, multiple endocrine neoplasia type 2; NF 1, neurofibromatosis type 1; PGL, paraganglioma syndrome; VHL, von Hippel-Lindau syndrome.

**Source:** Adapted from the Freiburg International Pheochromocytoma and Paraganglioma Registry.

medullary thyroid carcinoma (MTC), pheochromocytoma, and hyperparathyroidism; MEN2B also includes MTC and pheochromocytoma, as well as multiple mucosal neuromas, although it typically lacks hyperparathyroidism. Although MTC is seen in virtually all patients with MEN2, pheochromocytoma occurs in only ~50% of patients. Most pheochromocytomas are benign, located in the adrenals, and bilateral (Fig. 48-3). Pheochromocytoma may be symptomatic before MTC. Prophylactic thyroidectomy is being performed in many carriers of *RET* mutations; pheochromocytomas should be excluded before surgery in these patients.

*Von Hippel-Lindau syndrome (VHL)* is an autosomal dominant disorder that predisposes to retinal and cerebellar hemangioblastomas, which also occur in the brainstem and spinal cord (Fig. 48-4). Other important features of VHL are clear cell renal carcinomas, pancreatic islet cell tumors, endolymphatic sac tumors (ELSTs) of the inner ear, cystadenomas of the

epididymis and broad ligament, and multiple pancreatic or renal cysts.

The *VHL* gene encodes an E3 ubiquitin ligase that regulates expression of hypoxia-inducible factor-1 (HIF-1), among other genes. Loss of *VHL* is associated with increased expression of vascular endothelial growth factor (VEGF), which induces angiogenesis. Although the *VHL* gene can be inactivated by all types of mutations, patients with pheochromocytoma predominantly have missense mutations. About 20–30% of patients with VHL have pheochromocytomas, but in some families, the incidence can reach 90%. The recognition of pheochromocytoma as a VHL-associated feature provides an opportunity to diagnose retinal, renal, and central nervous system tumors at an earlier stage.

The *paraganglioma syndromes (PGL)* have been classified by genetic analyses of families with head and neck paragangliomas. The susceptibility genes encode subunits

**FIGURE 48-2**

**Neurofibromatosis.** **A.** MRI of bilateral adrenal pheochromocytoma. **B.** Cutaneous neurofibromas. **C.** Lisch nodules of the iris. **D.** Axillary freckling. [A, from HPH Neumann et al: *The Keio J Med* 54(1):15, 2005; with permission.]

of the enzyme succinate dehydrogenase (SDH), a component in the Krebs cycle and the mitochondrial electron transport chain. SDH is formed by four subunits (A–D). Mutations of *SDHB* (PGL4), *SDHC* (PGL3), and *SDHD* (PGL1) predispose to three of the paraganglioma syndromes (Table 48-3). The gene for PGL2 has not been identified yet. Mutations of *SDHA* do not predispose to paraganglioma tumors but instead cause Leigh's disease, a form of encephalopathy. The transmission of *SDHC* and *SDHB* mutations is autosomal dominant. In contrast, *SDHD* families exhibit a gene imprinting effect: only the offspring of affected fathers develop tumors. In a small number of patients with familial pheochromocytoma, a mutation has not yet been identified.

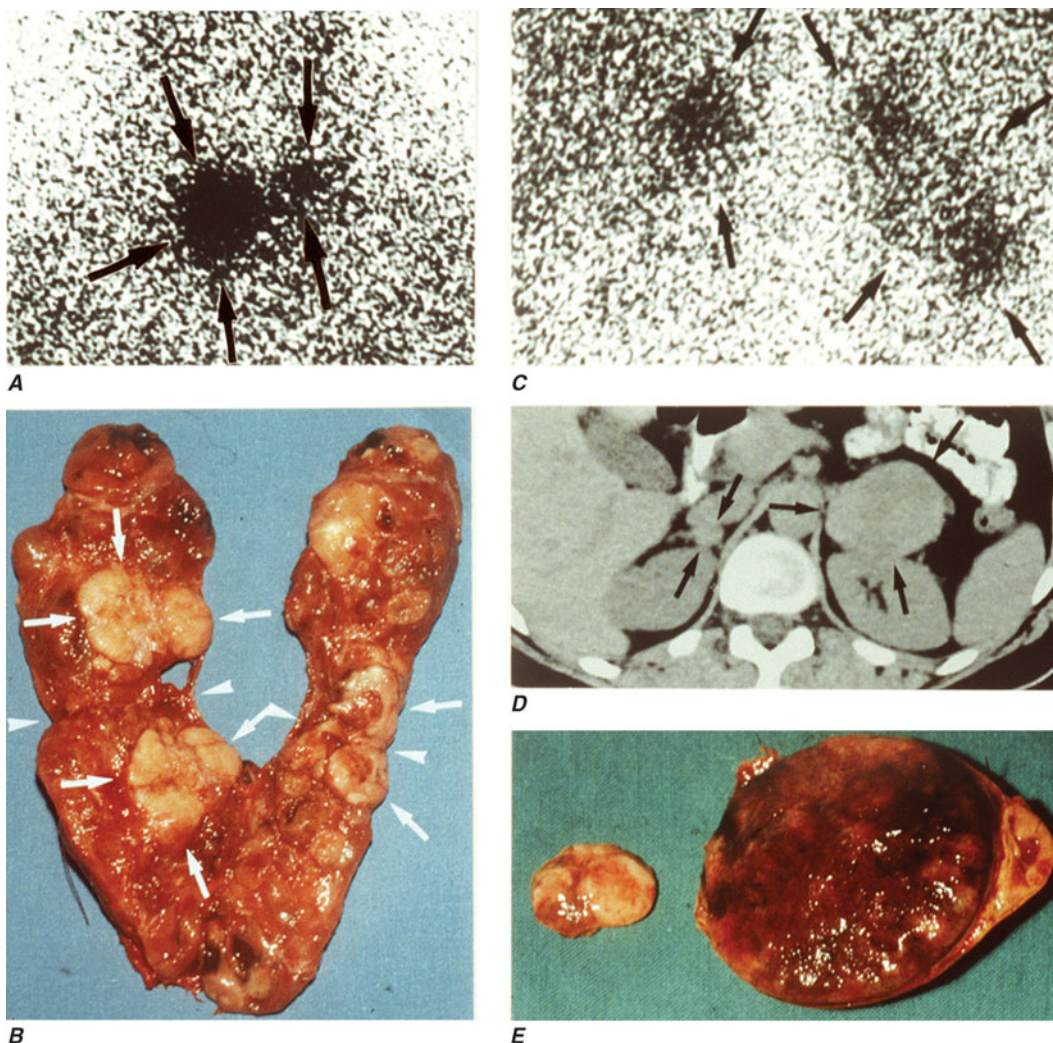
PGL1 is most frequent, followed by PGL4, and PGL3 is rare. Adrenal, extraadrenal abdominal, and thoracic pheochromocytomas are components of PGL1 and PGL4, but not of PGL3 (Fig. 48-5). About a third of the patients develop metastases.

### **GUIDELINES FOR GENETIC SCREENING IN PATIENTS WITH PHEOCHROMOCYTOMA OR PARAGANGLIOMA**

In addition to family history, general features suggesting an inherited syndrome include young age, multifocal tumors, extraadrenal tumors, or malignant tumors

(Fig. 48-6). Given the relatively high prevalence of familial syndromes among patients who present with pheochromocytoma or paraganglioma, it is useful to identify germ-line mutations, even in patients without a known family history. A first step is to search for clinical features of inherited syndromes and to perform an in-depth, multigenerational family history. Each of these syndromes exhibits autosomal dominant transmission with variable penetrance (Table 48-3). Cutaneous neurofibromas, café au lait spots, and axillary freckling suggest neurofibromatosis. Germ-line mutations in *NF1* have not been reported in patients with sporadic pheochromocytomas. Thus *NF1* testing does not need to be performed in the absence of other clinical features of neurofibromatosis. A personal or family history of medullary thyroid cancer or parathyroid tumors strongly suggests MEN2 and should prompt testing for *RET* mutations. A history of visual impairment, or tumors of the cerebellum, kidney, brainstem, or spinal cord, suggests the possibility of *VHL*.

A single adrenal pheochromocytoma in a patient with an otherwise unremarkable history may still be associated with mutations of *VHL*, *RET*, *SDHB*, or *SDHD* (in decreasing order of frequency). Two-thirds of extraadrenal tumors are associated with one of these syndromes, and multifocal tumors occur with decreasing frequency in carriers of *RET*, *SDHD*, *VHL*, and *SDHB* mutations. About 25% of head and neck paragangliomas

**FIGURE 48-3**

**Multiple endocrine neoplasia type 2.** Multifocal medullary thyroid carcinoma shown by (A) MIBG scintigraphy and (B) operative specimen; arrows demonstrate the tumors; arrowheads show the tissue bridge of the cut specimen. Bilateral adrenal pheochromocytoma shown by (C) MIBG scintigraphy, (D) CT imaging, and (E) operative specimens. [From HPH Neumann et al: *The Keio J Med* 54(1):15, 2005; with permission.]

are associated with germ-line mutations of one of the SDH subunit genes (particularly *SDHD*) and are rare in carriers of *VHL* or *RET* mutations.

Once the underlying syndrome is diagnosed, the benefit of genetic testing can be extended to relatives. For this purpose, it is necessary to identify the germ-line mutation in the proband and, after genetic counseling, perform DNA sequence analyses of the responsible gene in relatives to determine if they are affected. Other family members may benefit from biochemical screening for tumors in individuals who carry a germ-line mutation.

## ADRENOCORTICAL TUMORS

Tumors of the adrenal gland are common. They are categorized by whether or not they secrete hormones (functional vs nonfunctional) and whether they are histologically benign or malignant. About 85% of the tumors are benign nonfunctional adenomas and are usually discovered incidentally after abdominal imaging for an unrelated medical problem. Such tumors are called adrenal incidentalomas. Among all abdominal CT scans,

~3–4% show adrenal masses. About half of these tumors are adrenal metastases from other primary sites. In autopsy series, adrenal masses have been noted in 9% of normotensive and 12% of hypertensive patients. The adrenal masses are bilateral in 10–15% of cases.

Among the 15% of adrenal tumors that are functional, 9% (60% of functional tumors) are associated with clinical or subclinical Cushing's syndrome (secreting glucocorticoids independently from ACTH control), 4% are pheochromocytomas (vide supra), and 1–2% are associated with Conn's syndrome (secreting mineralocorticoids independently from renin/angiotensin control). Rarely a functional adrenal tumor may produce androgens resulting in virilization or estrogens resulting in feminization.

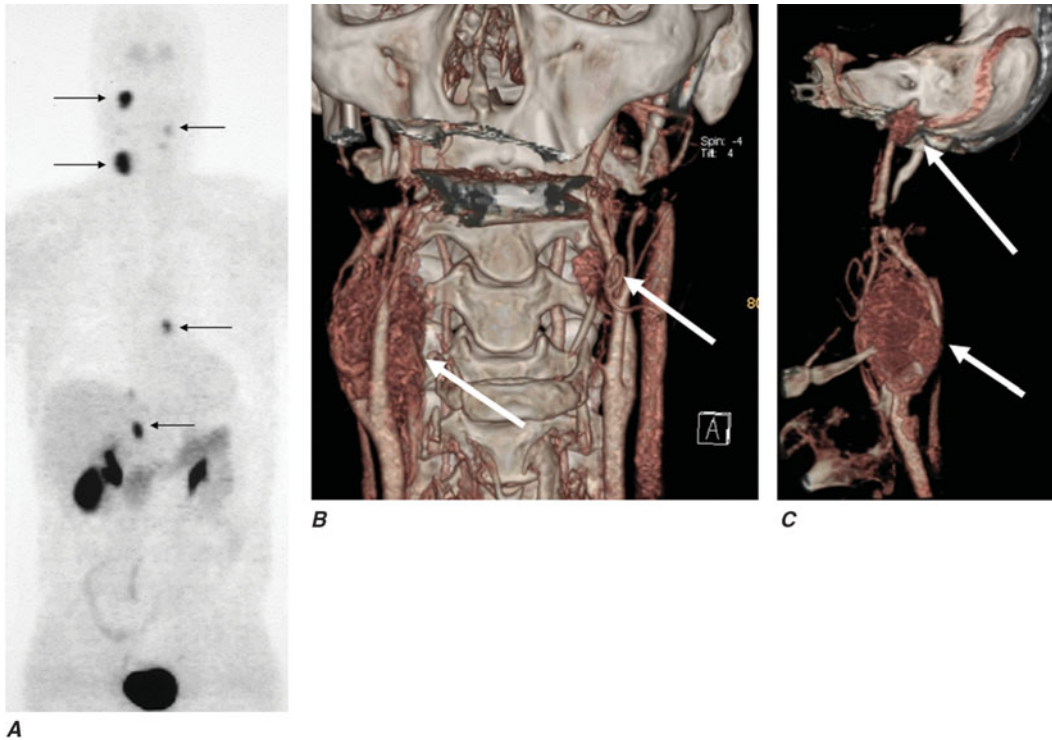
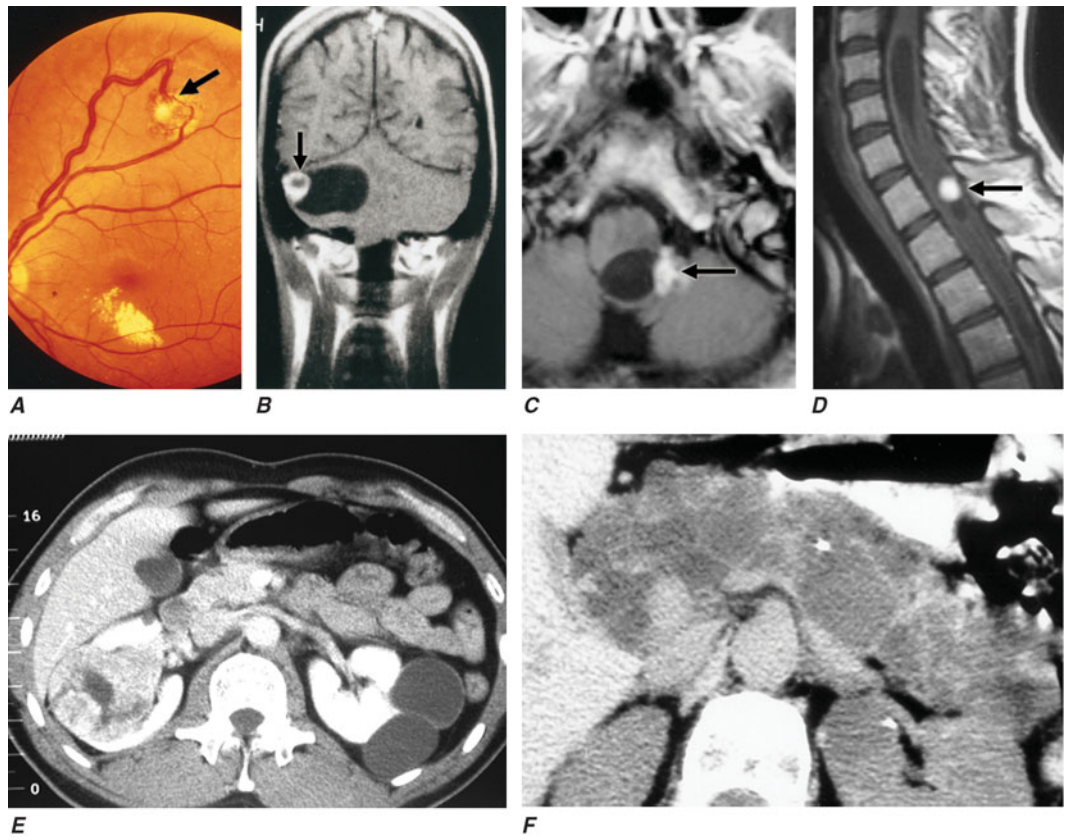
## INCIDENCE AND ETIOLOGY

Malignant tumors of the adrenal gland are very rare, ~1 case per 1 million people per year. Adrenocortical carcinomas may occur at any age, but two peaks are noted: one in children <5 years of age and another in the



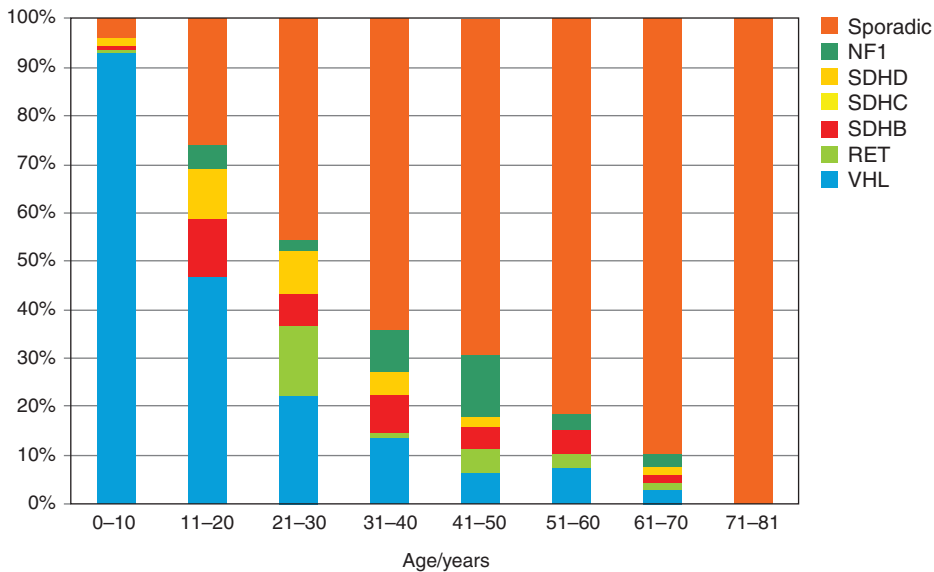
**FIGURE 48-4**

**Von Hippel-Lindau disease with extraparaganglial features.** Retinal angioma (**A**); hemangioblastomas of cerebellum are shown by MRI in (**B**) brainstem; (**C** and **D**) spinal cord; (**E**) carcinoma of the right kidney, cysts of the left kidney; and (**F**) multiple pancreatic cysts. [**A, D**, from HPH Neumann et al: *Adv Nephrol Necker Hosp* 27:361, 1997. Copyright Elsevier. **B**, from *Inherited Disorders of the Kidney*, SH Morgan, J-P Grunfeld (eds). Oxford, Oxford Univ Press, 1998. **E, F**, from HPH Neumann et al: *Contrib Nephrol* 136:193, 2001. Copyright S. Karger AG, Basel.]

**FIGURE 48-5**

**Paraganglioma syndrome.** PGL1, a patient with incomplete resection of a left carotid body tumor and the *SDHD* W5X mutation. **A**.  $^{18}\text{F}$ -dopa positron-emission tomography demonstrating tumor uptake in the right jugular glomus, the right carotid body, the left carotid body, the left coronary glomus, and the right adrenal gland. Note the physiologic accumulation

of the radiopharmaceutical agent in the kidneys, liver, gallbladder, renal pelvis, and the urinary bladder. **B** and **C**. CT angiography with 3D reconstruction. Arrows point to the paragangliomas. [From S Hoegerle et al: *Eur J Nucl Med Mol Imaging* 30(5):689, 2003; with permission.]

**FIGURE 48-6**

**Mutation distribution in the *RET*, *VHL*, *NF1*, *SDHB*, *SDHC*, and *SDHD* genes.** The bars depict the frequency of sporadic or various inherited forms of pheochromocytoma in different age groups. The inherited disorders are much more common among younger individuals presenting with pheochromocytoma. (Data from the Freiburg International Pheochromocytoma and Paraganglioma Registry.)

fourth and fifth decade. The disease tends to be more aggressive in adults. Adrenocortical carcinomas occur at a tenfold higher frequency among the children of southern Brazil.

The malignant tumor may occur together with a benign adenoma leading some to speculate that the malignancy is derived from the adenoma through accumulation of genetic lesions in a fashion analogous to colonic adenomas preceding colon cancers.

## GENETIC CONSIDERATIONS



Sporadic adrenocortical carcinoma is commonly associated with loss of heterozygosity at chromosome 17p13, but somewhat surprisingly, only about a third of tumors show mutations in p53, the gene at that site most frequently involved in cancer. The cases in children from southern Brazil often have a particular germ-line mutation in p53 (R337H), but the families of these children do not have a cancer-prone phenotype associated with germ-line p53 mutations (Li-Fraumeni syndrome). Gene amplification of the steroidogenic factor-1 (SF-1) gene is also commonly noted.

Among the more common genetic alterations in sporadic adult tumors is loss of heterozygosity and loss of imprinting of the insulin-like growth factor II (IGF-II) gene on chromosome 11p, resulting in overexpression of this growth factor. Activating mutations in  $\beta$ -catenin are also noted.

Much more uncommonly, adrenocortical carcinoma may be a tumor that occurs in families with genetic cancer predisposition including Li-Fraumeni syndrome (p53 inactivation, 17p13), Beckwith-Wiedemann syndrome (loss of imprinting of IGF-II, 11p13), and multiple endocrine neoplasia I (MEN1 inactivation, 11q13; most of these adrenal tumors are adenomas).

## CLINICAL FEATURES

Adrenocortical cancers may present in three major ways: (1) with symptoms of either glucocorticoid (or less commonly mineralocorticoid excess) and/or virilization; (2) with symptoms from the mass of the tumor (flank or abdominal pain) or its invasion of some other organ; and (3) incidentally. Sixty percent of adrenocortical carcinomas are functional (hormone secreting). The frequency of functional tumors declines with age; nonfunctioning tumors may be more aggressive clinically. About 45% of patients with functional tumors have Cushing's syndrome, and another 25% have Cushing's syndrome with virilization. In a patient with an adrenal mass and Cushing's syndrome, the coexistence of virilization suggests cancer, not adenoma. Some 15–20% have subclinical hormone excess. Ten percent each have hyperaldosteronism and feminization.

Patients with Cushing's syndrome may have obesity, hypertension, glucose intolerance, diabetes, muscle wasting, acne, moon facies, purple striae, a buffalo hump, hypokalemia, and osteoporosis. Often the symptoms may develop over 3–6 months. Patients with virilization may not show the catabolic effects of glucocorticoids because those manifestations are antagonized by androgen action. Patients with mineralocorticoid excess may have treatment-refractory hypertension, hypokalemia, and metabolic alkalosis.

Adrenocortical carcinomas may be locally invasive and most commonly spread to the liver, lungs, lymph nodes, and bone.

## DIAGNOSTIC APPROACH

The critical issue is to distinguish benign from malignant adrenal neoplasms. Because of the high prevalence

618 of benign tumors, nearly any diagnostic approach will lead to removal of substantially more benign than malignant tumors. Indeed, if benign tumors removed at surgery do not outnumber cancers by 8–10:1, the threshold for performing surgery is probably too high, and some cancers are likely escaping early detection.

A careful history and physical examination should assess the presence of signs and symptoms of hormonal excess. In a patient with a known adrenal mass, the diagnostic workup has three components: hormonal evaluation, imaging, and tissue evaluation. Blood tests should include fasting blood glucose, serum potassium, serum estradiol, estrone, and adrenal androgens. In addition, a 24-h urine free cortisol measurement should be obtained. The patient should have a dexamethasone suppression test with 1 mg of dexamethasone given at bedtime and serum obtained after an overnight fast at 8 AM. Urinary free cortisol levels  $>50 \mu\text{g/d}$  ( $140 \text{ nmol/d}$ ) and AM plasma cortisol after dexamethasone the night before  $>2 \mu\text{g/dL}$  ( $50 \text{ nmol/L}$ ) suggest glucocorticoid excess.

Imaging is a critical tool in assessing the benign or malignant nature of an adrenal mass. Size of the mass is one criterion for measuring the probability of malignancy; 90% of adrenocortical carcinomas are  $>6 \text{ cm}$ , but adenomas may also reach that size. About three-quarters of tumors  $>4 \text{ cm}$  in diameter are benign.

Other features of diagnostic imaging that are helpful include the density of the mass on CT scan in the absence of contrast material. Masses with a density  $<10$  Hounsfield units (HU) (reflecting the density of fat) are nearly always benign adenomas. Benign tumors are also homogeneous with a smooth border. By contrast, malignant adrenal tumors are denser ( $>20 \text{ HU}$ ), inhomogeneous, and more often have irregular borders. Another useful distinguishing feature is the speed with which contrast material is washed out of the mass. Benign masses tend to show rapid contrast washout; more than half the contrast is gone 10 min after administration. Malignant tumors retain contrast beyond 10 min.

MRI scans are not essential but can provide additional information, particularly in defining local invasiveness into adjacent organs and vessels. Chemical shift imaging can distinguish the protons in fat from those in water; the lipid content of tumors is usually lower than that of adenomas. Like CT scans, T2-weighted MRI images confirm the higher density of carcinomas compared to adenomas.

Fine-needle aspiration (FNA) is useless to distinguish an adrenal adenoma from an adrenocortical carcinoma. The main value of FNA is in a patient with a history of another cancer. In this setting, FNA can rule out (or more often, rule in) metastatic disease. If the imaging tests provide cause for concern based on size ( $>4 \text{ cm}$ ), contour (irregular), inhomogeneity, density, and slow contrast washout, the definitive approach to obtaining tissue is a surgical procedure in which the adrenal gland is excised in its entirety.

## STAGING

No TNM staging classification for adrenocortical cancer has been adopted by the American Joint Committee on Cancer. The European Network for the Study of Adrenal Tumors proposed the following scheme based on an analysis of data from the German Adrenocortical Cancer Registry: stage I, disease confined to the adrenal gland, tumor  $\leq 5 \text{ cm}$  in greatest diameter (T1); stage II, disease confined to the adrenal gland, tumor  $>5 \text{ cm}$  in greatest diameter (T2); stage III, tumor of any size with at least one of the following factors: tumor infiltration of surrounding tissues (T3), tumor invasion into tumor thrombus in the inferior vena cava or renal vein (T4), lymph node involvement (N1), but no distant metastases; stage IV, distant metastases present. The prognosis is related to disease stage. Five-year survival is 82% for stage I, 61% for stage II, 50% for stage III, and 13% for stage IV.

### **Rx Treatment:** **ADRENOCORTICAL CARCINOMA**

Complete surgical resection is the treatment of choice for stages I, II, and III disease. Intracaval extension is not a contraindication to an effort to excise all of the tumor. Patients with unresectable disease have a median survival of 6 months. In patients whose tumor is completely resected, the use of adjuvant therapy is controversial. However, many investigators use oral mitotane, 2 g daily, as adjuvant therapy for at least 2 years or until disease recurrence. Patients with metastatic disease are usually treated with mitotane that is slowly increased to reach the maximum tolerated dose in the individual. Although response may be noted from mitotane or mitotane combined with other chemotherapeutic agents, responses are often short and the survival of patients has not been substantially prolonged. In patients progressing on adjuvant mitotane, surgical resection, if possible, followed by mitotane plus etoposide, doxorubicin, and cisplatin or mitotane plus streptozotocin may produce some palliation, although it would be best if patients with this unusual cancer were part of organized clinical trials. Surgery, local radiation therapy, and radiofrequency ablation may palliate local problems in some patients. Chemoembolization may control liver metastases for a time.

Mitotane destroys the adrenal cortex with the glucocorticoid-producing cells more sensitive than the mineralocorticoid-producing cells. Patients being started on mitotane should be treated to prevent hypocortisolism (preferably with prednisone) and monitored for the development of hypoadosteronism. In the setting of incomplete resection or recurrence of functional tumors, hypercortisolism may be managed ketoconazole

(200 mg tid, with monitoring of urine cortisol levels), metyrapone (250 mg qid), or aminoglutethimide (250 mg tid). Doses of the antagonists may need to be increased based on the adrenal suppression noted in each individual.

In addition to causing damage to the adrenal cortex, mitotane is associated with nausea, vomiting, anorexia, rash, diarrhea, lethargy, sedation, dizziness, gynecomastia, arthralgias, elevated LDL cholesterol, hypouricemia, and liver toxicity (particularly elevated alkaline phosphatase and gamma-glutamyl transpeptidase). Because the toxic effects can mimic glucocorticoid deficiency, it is best to assess whether a higher dose of prednisone may ameliorate what appear to be mitotane toxicities before reducing the mitotane dose.

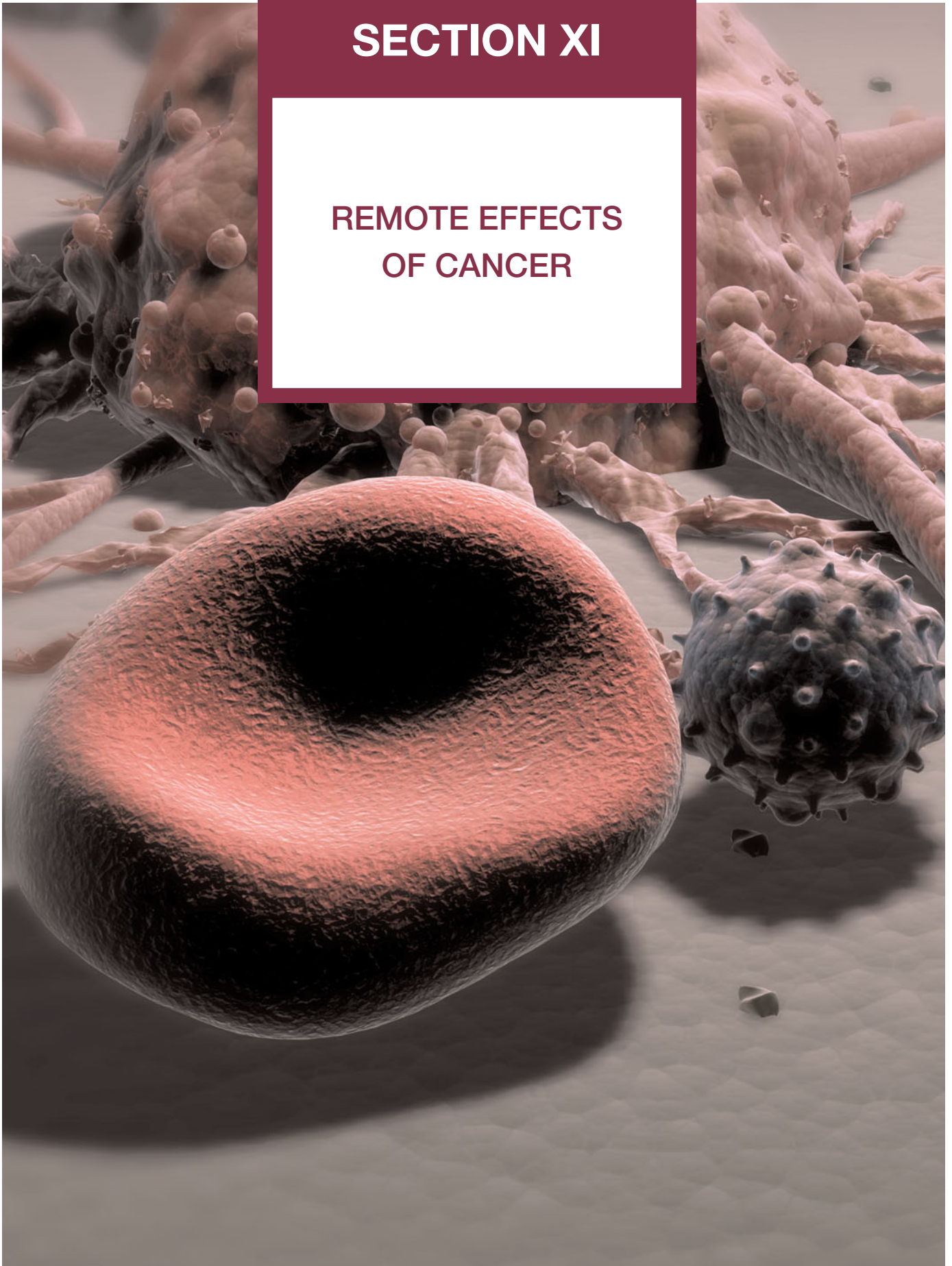
### FURTHER READINGS

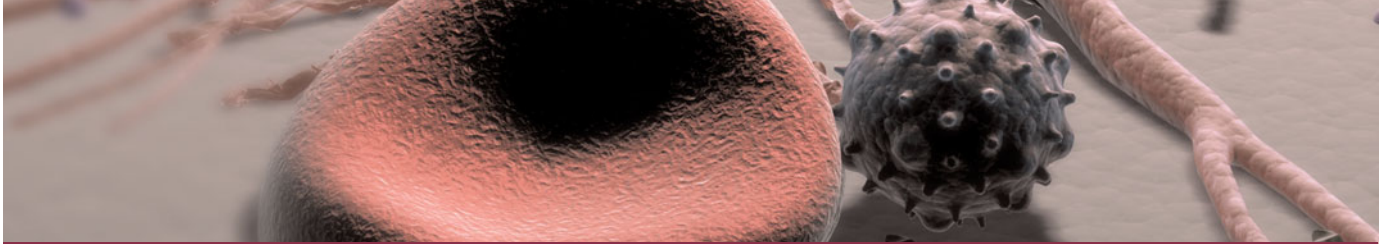
- BAUSCH B et al: Clinical and genetic characteristics of patients with neurofibromatosis type 1 and pheochromocytoma. *N Engl J Med* 354:2729, 2006
- et al: Germline NF1 mutational spectra and loss-of-heterozygosity analyses in patients with pheochromocytoma and neurofibromatosis type 1. *J Clin Endocrinol Metab* 92:2784, 2007
- KASSIM TA et al: Catecholamine-induced cardiomyopathy. *Endocr Pract* 14:1137, 2008
- LENDERS JW et al: Pheochromocytoma. *Lancet* 366:665, 2005
- NEUMANN HP et al: Germ-line mutations in nonsyndromic pheochromocytoma. *N Engl J Med* 346:1459, 2002
- et al: Distinct clinical features of paraganglioma syndromes associated with *SDHB* and *SDHD* gene mutations. *JAMA* 292:943, 2004
- et al: Evidence of MEN-2 in the original description of classic pheochromocytoma. *N Engl J Med* 357:1311, 2007
- PATALANO A et al: Adrenocortical cancer treatment. *Horm Res* 71 (Suppl 1):99, 2009
- SCHOLZ T et al: Clinical review: Current treatment of malignant pheochromocytoma. *J Clin Endocrinol Metab* 92:1217, 2007
- Terzolo M et al: Management of adrenal incidentaloma. *Best Pract Res Clin Endocrinol Metab* 23:233, 2009
- VAN BRAECKEL P et al: Perioperative management of pheochromocytoma. *Acta Anaesthesiol Belg* 60:55, 2009
- WALZ MK et al: Laparoscopic and retroperitoneoscopic treatment of pheochromocytomas and retroperitoneal paragangliomas: Results of 161 tumors in 126 patients. *World J Surg* 30:899, 2006

*This page intentionally left blank*

# SECTION XI

## REMOTE EFFECTS OF CANCER





## CHAPTER 49

# PARANEOPLASTIC SYNDROMES: ENDOCRINOLOGIC/HEMATOLOGIC

J. Larry Jameson ■ Bruce E. Johnson

■ Endocrine Paraneoplastic Syndromes . . . . .	.622	■ Hematologic Syndromes . . . . .	.628
Hypercalcemia Caused by Ectopic Production of PTHrP . . . . .	.623	Erythrocytosis . . . . .	.628
Ectopic Vasopressin: Tumor-Associated SIADH . . . . .	.625	Granulocytosis . . . . .	.629
Cushing's Syndrome Caused by Ectopic ACTH Production . . . . .	.626	Thrombocytosis . . . . .	.629
Tumor-Induced Hypoglycemia Caused by Excess		Eosinophilia . . . . .	.629
Production of IGF-II . . . . .	.627	Thrombophlebitis . . . . .	.629
Human Chorionic Gonadotropin . . . . .	.627	■ Further Readings . . . . .	.630
Oncogenic Osteomalacia . . . . .	.628		

In addition to local tissue invasion and metastasis, neoplastic cells can produce a variety of peptides that can stimulate hormonal, hematologic, dermatologic, or neurologic responses. *Paraneoplastic syndromes* refer to the disorders that accompany benign or malignant tumors but are not directly related to mass effects or invasion. Tumors of neuroendocrine origin, such as small cell lung carcinoma (SCLC) and carcinoids, produce a wide array of peptide hormones and are common causes of paraneoplastic syndromes. However, almost every type of malignancy has the potential to produce hormones or cytokines, or to induce immunologic responses. Careful studies of the prevalence of paraneoplastic syndromes indicate that they are more common than is generally appreciated. The signs, symptoms, and metabolic alterations associated with paraneoplastic disorders may be overlooked in the context of a malignancy and its treatment. Consequently, atypical clinical manifestations in a patient with cancer should prompt consideration of a paraneoplastic syndrome. The most common endocrinologic and hematologic syndromes associated with underlying neoplasia are discussed here.

### ENDOCRINE PARANEOPLASTIC SYNDROMES

#### *Etiology*

Hormones can be produced from eutopic or ectopic sources. *Eutopic* refers to the expression of a hormone from its normal tissue of origin, whereas *ectopic* refers to hormone production from an atypical tissue source. For example, adrenocorticotropic hormone (ACTH) is expressed eutopically by the corticotrope cells of the anterior pituitary, but it can be expressed ectopically in SCLC. Many hormones are produced at low levels from a wide array of tissues, in addition to the classic endocrine source. Thus ectopic expression is often a quantitative change rather than an absolute change in tissue expression. Nevertheless, the term *ectopic expression* is firmly entrenched and conveys the abnormal physiology associated with neoplastic hormone production. In addition to high levels of hormones, ectopic expression is typically characterized by abnormal regulation of hormone production (e.g., defective feedback control) and peptide processing (resulting in large, unprocessed precursors).

A diverse array of molecular mechanisms has been suggested to cause ectopic hormone production, but this process remains incompletely understood. In rare instances, genetic rearrangements explain aberrant hormone expression. For example, translocation of the *parathyroid hormone (PTH)* gene resulted in high levels of PTH expression in an ovarian carcinoma, presumably because the genetic rearrangement brings the *PTH* gene under the control of ovary-specific regulatory elements. A related phenomenon is well documented in many forms of leukemia and lymphoma, in which somatic genetic rearrangements confer a growth advantage and alter cellular differentiation and function (Chap. 15). Although genetic rearrangements may cause selected cases of ectopic hormone production, this mechanism is probably unusual because many tumors are associated with excessive production of numerous peptides. It is likely that cellular dedifferentiation underlies most cases of ectopic hormone production. In support of this idea, many cancers are poorly differentiated histologically, and certain tumor products, such as human chorionic gonadotropin (hCG), parathyroid hormone-related protein (PTHrP), and  $\alpha$  fetoprotein, are characteristic of gene expression at earlier developmental stages. However, the propensity of certain cancers to produce particular hormones (e.g., squamous cell carcinomas produce PTHrP) suggests that dedifferentiation is partial or that selective pathways are derepressed. These expression profiles are likely to be driven by alterations in transcriptional repression, changes in DNA methylation, or other factors that govern cell differentiation. Consistent with this idea, many solid tumors harbor poorly differentiated “cancer stem cells,” a subpopulation of cells that are capable of initiating new tumors.

In SCLC, the pathway of differentiation has been defined. The neuroendocrine phenotype is dictated in part by the basic-helix-loop-helix (bHLH) transcription factor human achaete-scute homologue 1 (hASH-1), which is expressed at abnormally high levels in SCLC associated with ectopic ACTH. The activity of hASH-1 is inhibited by hairy enhancer of split 1 (HES-1) and by Notch proteins, which are also capable of inducing growth arrest. Thus abnormal expression of these developmental transcription factors appears to provide a link between cell proliferation and differentiation.

Ectopic hormone production would only be an epiphenomenon associated with cancer if it did not result in clinical manifestations. Excessive and unregulated production of hormones such as ACTH, PTHrP, or vasopressin can lead to substantial morbidity and can complicate the cancer treatment plan. Moreover, the paraneoplastic endocrinopathies are sometimes the presenting feature of underlying malignancy and may prompt the search for an unrecognized tumor.

A large number of paraneoplastic endocrine syndromes have been described, linking overproduction of particular hormones with specific types of tumors. However, certain recurring syndromes emerge from this group (Table 49-1). The most common paraneoplastic endocrine syndromes include hypercalcemia from overproduction of PTHrP and other factors, hyponatremia from excess vasopressin, and Cushing’s syndrome from ectopic ACTH.

## HYPERCALCEMIA CAUSED BY ECTOPIC PRODUCTION OF PTHrP

### *Etiology*

Humoral hypercalcemia of malignancy (HHM) occurs in up to 20% of patients with cancer. HHM is most common in cancers of the lung, head and neck, skin, esophagus, breast, genitourinary tract, and in multiple myeloma and lymphomas. Several distinct humoral causes of HHM occur, most commonly overproduction of PTHrP. In addition to acting as a circulating humoral factor, bone metastases (e.g., breast, multiple myeloma) may produce PTHrP, leading to local osteolysis and hypercalcemia.

PTHrP is structurally related to PTH and it binds to the PTH receptor, explaining the similar biochemical features of HHM and hyperparathyroidism. PTHrP plays a key role in skeletal development and regulates cellular proliferation and differentiation in other tissues including skin, bone marrow, breast, and hair follicles. The mechanism of PTHrP induction in malignancy is incompletely understood; however, tumor-bearing tissues commonly associated with HHM normally produce PTHrP during development or cell renewal. Mutations in certain oncogenes, such as *Ras*, can activate PTHrP expression. In adult T cell lymphoma, the transactivating Tax protein produced by human T-cell lymphotropic virus I (HTLV-I) stimulates PTHrP promoter activity. Metastatic lesions to bone are more likely to produce PTHrP than are metastases in other tissues, suggesting that bone produces factors that enhance PTHrP production, or that PTHrP-producing metastases have a selective growth advantage in bone. Thus PTHrP production can be stimulated by mutations in oncogenes, by altered expression of viral or cellular transcription factors, and by local growth factors.

Another relatively common cause of HHM is excess production of 1,25-dihydroxyvitamin D. Like granulomatous disorders associated with hypercalcemia, lymphomas can produce an enzyme that converts 25-hydroxyvitamin D to the more active 1,25-dihydroxyvitamin D, leading to enhanced gastrointestinal calcium absorption. Other causes of HHM include tumor-mediated production of osteolytic cytokines and inflammatory mediators.



**PARANEOPLASTIC SYNDROMES CAUSED BY ECTOPIC HORMONE PRODUCTION**

PARANEOPLASTIC SYNDROME	ECTOPIC HORMONE	TYPICAL TUMOR TYPES <sup>a</sup>
<b>Common</b>		
Hypercalcemia of malignancy	Parathyroid hormone-related protein (PTHrP)	Squamous cell (head and neck, lung, skin), breast, genitourinary, gastrointestinal
	1,25 dihydroxyvitamin D	Lymphomas
	Parathyroid hormone (PTH) (rare)	Lung, ovary
	Prostaglandin E2 (PGE2) (rare)	Renal, lung
Syndrome of inappropriate antidiuretic hormone secretion (SIADH)	Vasopressin	Lung (squamous, small cell), gastrointestinal, genitourinary, ovary
Cushing's syndrome	Adrenocorticotrophic hormone (ACTH)	Lung (small cell, bronchial carcinoid, adenocarcinoma, squamous), thymus, pancreatic islet, medullary thyroid carcinoma
	Corticotropin-releasing hormone (CRH) (rare)	Pancreatic islet, carcinoid, lung, prostate
	Ectopic expression of gastric inhibitory peptide (GIP), luteinizing hormone (LH)/human chorionic gonadotropin (hCG), other G protein-coupled receptors (rare)	Macronodular adrenal hyperplasia
<b>Less Common</b>		
Non-islet cell hypoglycemia	Insulin-like growth factor (IGF-II)	Mesenchymal tumors, sarcomas, adrenal, hepatic, gastrointestinal, kidney, prostate
	Insulin (rare)	Cervix (small cell carcinoma)
Male feminization	hCG <sup>b</sup>	Testis (embryonal, seminomas), germiomas, choriocarcinoma, lung, hepatic, pancreatic islet
Diarrhea or intestinal hypermotility	Calcitonin <sup>c</sup>	Lung, colon, breast, medullary thyroid carcinoma
	Vasoactive intestinal peptide (VIP)	Pancreas, pheochromocytoma, esophagus
<b>Rare</b>		
Oncogenic osteomalacia	Phosphatonin [fibroblast growth factor 23 (FGF23)]	Hemangiopericytomas, osteoblastomas, fibromas, sarcomas, giant cell tumors, prostate, lung
Acromegaly	Growth hormone-releasing hormone (GHRH)	Pancreatic islet, bronchial and other carcinoids
	Growth hormone (GH)	Lung, pancreatic islet
Hyperthyroidism	Thyroid-stimulating hormone (TSH)	Hydatidiform mole, embryonal tumors, struma ovarii
Hypertension	Renin	Juxtaglomerular tumors, kidney, lung, pancreas, ovary

<sup>a</sup>Only the most common tumor types are listed. For most ectopic hormone syndromes, an extensive list of tumors has been reported to produce one or more hormones.

<sup>b</sup>hCG is produced ectopically by trophoblastic tumors. Certain tumors produce disproportionate amounts of the hCG  $\alpha$  or hCG  $\beta$  subunits. High levels of hCG rarely cause hyperthyroidism because of weak binding to the TSH receptor.

<sup>c</sup>Calcitonin is produced ectopically by medullary thyroid carcinoma and is used as a tumor marker.

### Clinical Manifestations

The typical presentation of HHM is a patient with a known malignancy who is found to be hypercalcemic on routine laboratory tests. Less often, hypercalcemia is the initial presenting feature of malignancy. Particularly when calcium levels are markedly increased [ $>3.5$  mmol/L ( $>14$  mg/dL)], patients may experience fatigue, mental status changes, dehydration, or symptoms of nephrolithiasis.

### Diagnosis

Features that favor HHM, as opposed to primary hyperparathyroidism, include known malignancy, recent onset of hypercalcemia, and very high serum calcium levels. Like hyperparathyroidism, hypercalcemia caused by PTHrP is accompanied by hypercalciuria and hypophosphatemia. Measurement of PTH is useful to exclude primary hyperparathyroidism; the PTH level should be suppressed in HHM. An elevated PTHrP level confirms

the diagnosis, and it is increased in ~80% of hypercalcemic patients with cancer. 1,25-Dihydroxyvitamin D levels may be increased in patients with lymphoma.

**Treatment:**  
**Rx HUMORAL HYPERCALCEMIA  
 OF MALIGNANCY**

The management of HHM begins with removal of excess calcium in the diet, medications, or IV solutions. Oral phosphorus (e.g., 250 mg Neutra-Phos three to four times daily) should be given until serum phosphorus is >1.0 mmol/L (>3 mg/dL). Saline rehydration is used to dilute serum calcium and promote kaliuresis. Forced diuresis with furosemide or other loop diuretics can enhance calcium excretion but provides relatively little value except in life-threatening hypercalcemia. When used, loop diuretics should be administered only after complete rehydration and with careful monitoring of fluid balance. Bisphosphonates such as pamidronate (30–90 mg IV), zoledronate (4–8 mg IV), or etidronate (7.5 mg/kg per day PO for 3–7 consecutive days) can reduce serum calcium within 1–2 days and suppress calcium release for several weeks. Bisphosphonate infusions can be repeated or oral bisphosphonates can be used for chronic treatment. Dialysis should be considered in severe hypercalcemia when saline hydration and bisphosphonate treatments are not possible or are too slow in onset. Previously used agents, such as calcitonin and mithramycin, have little utility now that bisphosphonates are available. Calcitonin (2–8 U/kg SC every 6–12 h) should be considered when rapid correction of severe hypercalcemia is needed. Hypercalcemia associated with lymphomas, multiple myeloma, or leukemia may respond to glucocorticoid treatment (e.g., prednisone 40–100 mg PO in four divided doses).

**ECTOPIC VASOPRESSIN:  
 TUMOR-ASSOCIATED SIADH**

**Etiology**

Vasopressin is an antidiuretic hormone normally produced by the posterior pituitary gland. Ectopic vasopressin production by tumors is a common cause of the syndrome of inappropriate antidiuretic hormone (SIADH), occurring in at least half of patients with SCLC. Compensatory mechanisms, such as decreased thirst, suppression of aldosterone, and production of atrial natriuretic peptide (ANP), may mitigate the development of hyponatremia in patients who produce excessive vasopressin. Tumors with neuroendocrine features, such as SCLC and carcinoids, are the most common sources of ectopic vasopressin production, but it also occurs in other forms of lung cancer and with central nervous system (CNS) lesions, head and neck

cancer, and genitourinary, gastrointestinal, and ovarian cancers. The mechanism of activation of the vasopressin gene in these tumors is unknown but often involves concomitant expression of the adjacent oxytocin gene, suggesting derepression of this locus.

**Clinical Manifestations**

Most patients with ectopic vasopressin secretion are asymptomatic and identified because of the presence of hyponatremia on routine chemistry testing. Symptoms may include weakness, lethargy, nausea, confusion, depressed mental status, and seizures. The severity of symptoms reflects the rapidity of onset as well as the extent of hyponatremia. Hyponatremia usually develops slowly but may be exacerbated by the administration of IV fluids or the institution of new medications. Thirst is typically suppressed.

**Diagnosis**

The diagnostic features of ectopic vasopressin production are the same as those of other causes of SIADH. Hyponatremia and reduced serum osmolality occur in the setting of an inappropriately normal or increased urine osmolality. Urine sodium excretion is normal or increased unless volume depletion is present. Other causes of hyponatremia should be excluded, including renal, adrenal, or thyroid insufficiency. Physiologic sources of vasopressin stimulation (CNS lesions, pulmonary disease, nausea), adaptive circulatory mechanisms (hypotension, heart failure, hepatic cirrhosis), and medications, including many chemotherapeutic agents, should also be considered as possible causes of hyponatremia. Vasopressin assay is not usually necessary to make the diagnosis.

**Treatment:**  
**Rx ECTOPIC VASOPRESSIN:  
 TUMOR-ASSOCIATED SIADH**

Most patients with ectopic vasopressin production develop hyponatremia over several weeks or months. The disorder should be corrected gradually unless mental status is altered or there is risk of seizures. Treatment of the underlying malignancy may reduce ectopic vasopressin production but this response is slow, if it occurs at all. Fluid restriction to less than urine output, plus insensible losses, is often sufficient to partially correct hyponatremia. However, strict monitoring of the amount and types of liquids consumed or administered intravenously is required for fluid restriction to be effective. Salt tablets or saline are not helpful unless volume depletion is also present. Demeclocycline (150–300 mg orally three to four times daily) can be used to inhibit vasopressin action on the renal distal tubule, but its

onset of action is relatively slow (1–2 weeks). Conivaptan, a nonpeptide  $V_2$ -receptor antagonist, can be administered either PO (20–120 mg bid) or IV (10–40 mg), and is particularly effective when used in combination with fluid restriction in euvolemic hyponatremia. Severe hyponatremia ( $\text{Na} < 115$  meq/L) or mental status changes may require treatment with hypertonic (3%) or normal saline infusion together with furosemide, to enhance free water clearance. The rate of sodium correction should be slow (0.5–1 meq/L per h) to prevent rapid fluid shifts and the possible development of central pontine myelinolysis.

## CUSHING'S SYNDROME CAUSED BY ECTOPIC ACTH PRODUCTION

### Etiology

Ectopic ACTH production accounts for 10–20% of Cushing's syndrome. The syndrome is particularly common in neuroendocrine tumors. SCLC (>50%) is by far the most common cause of ectopic ACTH, followed by thymic carcinoid (15%), islet cell tumors (10%), bronchial carcinoid (10%), other carcinoids (5%), and pheochromocytomas (2%). Ectopic ACTH production is caused by increased expression of the proopiomelanocortin (POMC) gene, which encodes ACTH, along with melanocyte-stimulating hormone (MSH),  $\beta$  lipotropin, and several other peptides. In many tumors, there is abundant but aberrant expression of the POMC gene from an internal promoter, proximal to the third exon, which encodes ACTH. However, because this product lacks the signal sequence necessary for protein processing, it is not secreted. Increased production of ACTH arises instead from less abundant, but unregulated, POMC expression from the same promoter site used in the pituitary. However, because the tumors lack many of the enzymes needed to process the POMC polypeptide, it is typically released as multiple large, biologically inactive fragments along with relatively small amounts of fully processed, active ACTH.

Rarely, corticotropin-releasing hormone (CRH) is produced by pancreatic islet tumors, SCLC, medullary thyroid cancer, carcinoids, or prostate cancer. When levels are high enough, CRH can cause pituitary corticotrope hyperplasia and Cushing's syndrome. Tumors that produce CRH sometimes also produce ACTH, raising the possibility of a paracrine mechanism for ACTH production.

A distinct mechanism for ACTH-independent Cushing's syndrome involves ectopic expression of various G protein-coupled receptors in the adrenal nodules. Ectopic expression of the gastric inhibitory peptide (GIP) receptor is the best characterized example of this mechanism. In this case, meals induce GIP secretion,

which inappropriately stimulates adrenal growth and glucocorticoid production.

### Clinical Manifestations

The clinical features of hypercortisolemia are detected in only a small fraction of patients with documented ectopic ACTH production. Patients with ectopic ACTH syndrome generally exhibit less marked weight gain and centripetal fat redistribution, probably because the exposure to excess glucocorticoids is relatively short and because cachexia reduces the propensity for weight gain and fat deposition. The ectopic ACTH syndrome is associated with several clinical features that distinguish it from other causes of Cushing's syndrome (e.g., pituitary adenomas, adrenal adenomas, iatrogenic glucocorticoid excess). The metabolic manifestations of ectopic ACTH syndrome are dominated by fluid retention and hypertension, hypokalemia, metabolic alkalosis, glucose intolerance, and, often, steroid psychosis. The very high ACTH levels often cause increased pigmentation, and melanocyte-stimulating hormone (MSH) activity derived from the POMC precursor peptide is also increased. The extraordinarily high glucocorticoid levels in patients with ectopic sources of ACTH can lead to marked skin fragility and easy bruising. In addition, the high cortisol levels often overwhelm the renal  $11\beta$ -hydroxysteroid dehydrogenase type II enzyme, which normally inactivates cortisol and prevents it from binding to renal mineralocorticoid receptors. Consequently, in addition to the excess mineralocorticoids produced by ACTH stimulation of the adrenal gland, high levels of cortisol exert activity through the mineralocorticoid receptor, leading to severe hypokalemia.

### Diagnosis

The diagnosis of ectopic ACTH syndrome is usually not difficult in the setting of a known malignancy. Urine free cortisol levels fluctuate but are typically greater than two to four times normal and the plasma ACTH level is usually  $>22$  pmol/L ( $>100$  pg/mL). A suppressed ACTH level excludes this diagnosis and indicates an ACTH-independent cause of Cushing's syndrome (e.g., adrenal or exogenous glucocorticoid). In contrast to pituitary sources of ACTH, most ectopic sources of ACTH do not respond to glucocorticoid suppression. Therefore, high-dose dexamethasone (8 mg PO) suppresses 8:00 A.M. serum cortisol (50% decrease from baseline) in  $\sim 80\%$  of pituitary ACTH-producing adenomas but fails to suppress ectopic ACTH in  $\sim 90\%$  of cases. Bronchial and other carcinoids are well-documented exceptions to these general guidelines because these ectopic sources of ACTH may exhibit feedback regulation indistinguishable from pituitary adenomas, including suppression by high-dose

dexamethasone, and ACTH responsiveness to adrenal blockade with metyrapone. If necessary, petrosal sinus catheterization can be used to evaluate a patient with ACTH-dependent Cushing’s syndrome when the source of ACTH is unclear. After CRH stimulation, a 3:1 petrosal sinus-to-peripheral ACTH ratio strongly suggests a pituitary ACTH source. Imaging studies are also useful in the evaluation of suspected carcinoid lesions, allowing biopsy and characterization of hormone production using special stains.

**Rx Treatment:**  
**CUSHING’S SYNDROME CAUSED BY ECTOPIC ACTH PRODUCTION**

The morbidity associated with the ectopic ACTH syndrome can be substantial. Patients may experience depression or personality changes because of extreme cortisol excess. Metabolic derangements including diabetes mellitus and hypokalemia can worsen fatigue. Poor wound healing and predisposition to infections can complicate the surgical management of tumors, and opportunistic infections, caused by organisms such as *Pneumocystis carinii* and mycoses, are often the cause of death in patients with ectopic ACTH production. Depending on prognosis and treatment plans for the underlying malignancy, measures to reduce cortisol levels are often indicated. Treatment of the underlying malignancy may reduce ACTH levels but is rarely sufficient to reduce cortisol levels to normal. Adrenalectomy is not practical for most of these patients but should be considered if the underlying tumor is not resectable and the prognosis is otherwise favorable (e.g., carcinoid). Medical therapy with ketoconazole (200–400 mg PO bid), metyrapone (250–500 mg PO every 6 h), mitotane (3–6 g PO in four divided doses, tapered to maintain low cortisol production), or other agents that block steroid synthesis or action is often the most practical strategy for managing the hypercortisolism associated with ectopic ACTH production. Glucocorticoid replacement should be provided to avoid adrenal insufficiency. Unfortunately, many patients eventually progress despite medical blockade.

**TUMOR-INDUCED HYPOGLYCEMIA CAUSED BY EXCESS PRODUCTION OF IGF-II**

Mesenchymal tumors, hemangiopericytomas, hepatocellular tumors, adrenal carcinomas, and a variety of other large tumors have been reported to produce excessive amounts of insulin-like growth factor type II (IGF-II) precursor, which binds weakly to insulin receptors and strongly to IGF-I receptors, leading to insulin-like actions. The gene encoding IGF-II resides on a chromosome 11p15 locus that is normally imprinted (that is,

expression is exclusively from a single parental allele). Biallelic expression of the IGF-II gene occurs in a subset of tumors, suggesting loss of methylation and loss of imprinting as a mechanism for gene induction. In addition to increased IGF-II production, IGF-II bioavailability is increased due to complex alterations in circulating binding proteins. Increased IGF-II suppresses growth hormone (GH) and insulin, resulting in reduced IGF binding protein 3 (IGFBP-3), IGF-I, and acid-labile subunit (ALS). The reduction in ALS and IGFBP-3, which normally sequester IGF-II, causes it to be displaced to a small circulating complex that has greater access to insulin target tissues. For this reason, circulating IGF-II levels may not be markedly increased, despite causing hypoglycemia. In addition to IGF-II-mediated hypoglycemia, tumors may occupy enough of the liver to impair gluconeogenesis.

In most cases, the tumor causing hypoglycemia is clinically apparent and hypoglycemia develops in association with fasting. The diagnosis is made by documenting low serum glucose and suppressed insulin levels in association with symptoms of hypoglycemia. Serum IGF-II levels may not be increased (IGF-II assays may not detect IGF-II precursors). Increased IGF-II mRNA expression is found in most of these tumors. Any medications associated with hypoglycemia should be eliminated. Treatment of the underlying malignancy, if possible, may reduce the predisposition to hypoglycemia. Frequent meals and IV glucose, especially during sleep or fasting, are often necessary to prevent hypoglycemia. Glucagon, GH, and glucocorticoids have also been used to enhance glucose production.

**HUMAN CHORIONIC GONADOTROPIN**

hCG is composed of  $\alpha$  and  $\beta$  subunits and can be produced as intact hormone, which is biologically active, or as uncombined biologically inert subunits. Ectopic production of intact hCG occurs most often in association with testicular embryonal tumors, germ cell tumors, extragonadal germinomas, lung cancer, hepatoma, and pancreatic islet tumors. Eutopic production of hCG occurs with trophoblastic malignancies. Low levels of hCG or its uncombined  $\alpha$  or  $\beta$  subunits have been reported in a wide array of tumors. hCG  $\alpha$  subunit production is particularly common in lung cancer and pancreatic islet cancer. In men, high hCG levels stimulate steroidogenesis and aromatase activity in testicular Leydig cells, resulting in increased estrogen production and the development of gynecomastia. Precocious puberty in boys or gynecomastia in men should prompt measurement of hCG and consideration of a testicular tumor or another source of ectopic hCG production. Most women are asymptomatic. hCG is easily measured. Treatment should be directed at the underlying malignancy.

Hypophosphatemic oncogenic osteomalacia, also called tumor-induced osteomalacia (TIO), is characterized by markedly reduced serum phosphorus and renal phosphate wasting, leading to muscle weakness, bone pain, and osteomalacia. Serum calcium and PTH levels are normal and 1,25-dihydroxyvitamin D is low. Oncogenic osteomalacia is usually caused by benign mesenchymal tumors, such as hemangiopericytomas, fibromas, or giant cell tumors, often of the skeletal extremities or head. It has also been described in sarcomas and in patients with prostate and lung cancer. Resection of the tumor reverses the disorder, confirming its humoral basis. The circulating phosphaturic factor is called *phosphatonin*—a factor that inhibits renal tubular reabsorption of phosphate and renal conversion of 25-hydroxyvitamin D to 1,25-dihydroxyvitamin D. Phosphatonin has been identified as fibroblast growth factor 23 (FGF23). FGF23 levels are increased in some, but not all, patients with osteogenic osteomalacia. The disorder exhibits biochemical features similar to those seen with inactivating mutations in the *PHEX* gene, the cause of hereditary X-linked hypophosphatemia. The *PHEX* gene encodes a protease that activates FGF23. Treatment involves removal of the tumor, if possible, and supplementation with phosphate and vitamin D. Octreotide treatment reduces phosphate wasting in some patients with tumors that express somatostatin receptor subtype 2. Octreotide scans may also be useful to detect these tumors.

## HEMATOLOGIC SYNDROMES

The elevation of granulocyte, platelet, and eosinophil counts in most patients with myeloproliferative disorders is caused by the proliferation of the myeloid elements due to the underlying disease rather than a paraneoplastic syndrome. The paraneoplastic hematologic syndromes in patients with solid tumors are less well characterized than the endocrine syndromes because the ectopic hormone(s) or cytokines responsible have not been identified in most of these tumors (Table 49-2). The extent of the paraneoplastic syndromes parallels the course of the cancer.

### ERYTHROCYTOSIS

Ectopic production of erythropoietin by cancer cells causes most paraneoplastic erythrocytosis. The ectopically produced erythropoietin stimulates the production of red blood cells (RBC) in the bone marrow and raises the hematocrit. Other lymphokines and hormones produced by cancer cells may stimulate erythropoietin release but have not been proven to cause erythrocytosis.

Most patients with erythrocytosis have an elevated hematocrit (>52% in men; >48% in women) that is

TABLE 49-2

### PARANEOPLASTIC HEMATOLOGIC SYNDROMES

SYNDROME	PROTEINS	CANCERS TYPICALLY ASSOCIATED WITH SYNDROME
Erythrocytosis	Erythropoietin	Renal cancers Hepatocarcinoma Cerebellar heman- gioblastomas
Granulocytosis	G-CSF GM-CSF	Lung cancer Gastrointestinal cancer
	IL-6	Ovarian cancer Genitourinary cancer Hodgkin's disease
Thrombocytosis	IL-6	Lung cancer Gastrointestinal cancer Breast cancer Ovarian cancer
		Lymphoma
Eosinophilia	IL-5	Lymphoma Leukemia Lung cancer
Thrombophlebitis	Unknown	Lung cancer Pancreatic cancer Gastrointestinal cancer Breast cancer Genitourinary cancer Ovarian cancer Prostate cancer Lymphoma

**Note:** G-CSF, granulocyte colony-stimulating factor; GM-CSF, granulocyte-macrophage CSF; IL, interleukin.

detected on a routine blood count. Approximately 3% of patients with renal cell cancer, 10% of patients with hepatoma, and 15% of patients with cerebellar heman-  
gioblastomas have erythrocytosis. In most cases the erythrocytosis is asymptomatic.

Patients with erythrocytosis due to a renal cell cancer, hepatoma, or CNS cancer should have measurement of red cell mass. If the red cell mass is elevated, the serum erythropoietin level should then be measured. Patients with an appropriate cancer, elevated erythropoietin levels, and no other explanation for erythrocytosis (e.g., hemoglobinopathy that causes increased O<sub>2</sub> affinity; Chap. 2) have the paraneoplastic syndrome.

### **Rx** Treatment: ERYTHROCYTOSIS

Successful resection of the cancer usually resolves the erythrocytosis. If the tumor cannot be resected or treated effectively with radiation therapy or chemotherapy, phlebotomy may control any symptoms related to erythrocytosis.

## GRANULOCYTOSIS

Approximately 30% of patients with solid tumors have granulocytosis (granulocyte count  $>8000/\mu\text{L}$ ). In about half of patients with granulocytosis and cancer, the granulocytosis has an identifiable nonparaneoplastic etiology (infection, tumor necrosis, glucocorticoid administration, etc.). The other patients have proteins in urine and serum that stimulate the growth of bone marrow cells. Tumors and tumor cell lines from patients with lung, ovarian, and bladder cancers have been documented to produce granulocyte colony-stimulating factor (G-CSF), granulocyte-macrophage colony-stimulating factor (GM-CSF), and/or interleukin 6 (IL-6). However, the etiology of granulocytosis has not been characterized in most patients.

Patients with granulocytosis are nearly all asymptomatic, and the differential white blood cell count does not have a shift to immature forms of neutrophils. Granulocytosis occurs in 40% of patients with lung and gastrointestinal cancers, 20% of patients with breast cancer, 30% of patients with brain tumors and ovarian cancers, 20% of patients with Hodgkin's disease, and 10% of patients with renal cell carcinoma. Patients with advanced-stage disease are more likely to have granulocytosis than those with early-stage disease.

Paraneoplastic granulocytosis does not require treatment. The granulocytosis resolves when the underlying cancer is treated.

## THROMBOCYTOSIS

Some 35% of patients with thrombocytosis (platelet count  $>400,000/\mu\text{L}$ ) have an underlying diagnosis of cancer. IL-6, a candidate molecule for the etiology of paraneoplastic thrombocytosis, stimulates the production of platelets in vitro and in vivo. Some patients with cancer and thrombocytosis have elevated levels of IL-6 in plasma. Another candidate molecule is thrombopoietin, a peptide hormone that stimulates megakaryocyte proliferation and platelet production. The etiology of thrombocytosis has not been established in most cases.

Patients with thrombocytosis are nearly all asymptomatic. Thrombocytosis is not clearly linked to thrombosis in patients with cancer. Thrombocytosis is present in 40% of patients with lung and gastrointestinal cancers, 20% of patients with breast, endometrial, and ovarian cancers, and 10% of patients with lymphoma. Patients with thrombocytosis are more likely to have advanced-stage disease and have a poorer prognosis than patients without thrombocytosis. Paraneoplastic thrombocytosis does not require treatment.

## EOSINOPHILIA

Eosinophilia is present in  $\sim 1\%$  of patients with cancer. Tumors and tumor cell lines from patients with lymphomas or leukemia may produce IL-5, which stimulates

eosinophil growth. Activation of IL-5 transcription in lymphomas and leukemias may involve translocation of the long arm of chromosome 5, to which the genes for IL-5 and other cytokines map.

Patients with eosinophilia are typically asymptomatic. Eosinophilia is present in 10% of patients with lymphoma, 3% of patients with lung cancer, and occasional patients with cervical, gastrointestinal, renal, and breast cancer. Patients with markedly elevated eosinophil counts ( $>5000/\mu\text{L}$ ) can develop shortness of breath and wheezing. A chest radiograph may reveal diffuse pulmonary infiltrates from eosinophil infiltration and activation in the lungs.

### Rx Treatment: EOSINOPHILIA

Definitive treatment is directed at the underlying malignancy: tumors should be resected or treated with radiation or chemotherapy. In most patients who develop shortness of breath related to eosinophilia, symptoms resolve with the use of oral or inhaled glucocorticoids.

## THROMBOPHLEBITIS

Deep vein thrombosis and pulmonary embolism are the most common thrombotic conditions in patients with cancer. Migratory or recurrent thrombophlebitis may be the initial manifestation of cancer. Nearly 15% of patients who develop deep vein thrombosis or pulmonary embolism have a diagnosis of cancer (Chap. 20). The coexistence of peripheral venous thrombosis with visceral carcinoma, particularly pancreatic cancer, is called *Trousseau's syndrome*.

### Pathogenesis

Patients with cancer are predisposed to thromboembolism because they are often at bedrest or immobilized, and tumors may obstruct or slow blood flow. Chronic IV catheters also predispose to clotting. In addition, clotting may be promoted by release of procoagulants or cytokines from tumor cells or associated inflammatory cells, or by platelet adhesion or aggregation. The specific molecules that promote thromboembolism have not been identified.

In addition to cancer causing secondary thrombosis, primary thrombophilic diseases may be associated with cancer. For example, the antiphospholipid antibody syndrome is associated with a wide range of pathologic manifestations. About 20% of patients with this syndrome have cancers. Among patients with cancer and antiphospholipid antibodies, 35–45% develop thrombosis.

Patients with cancer who develop deep vein thrombosis usually develop swelling or pain in the leg, and physical examination reveals tenderness, warmth, and redness. Patients who present with pulmonary embolism develop dyspnea, chest pain, and syncope, and physical examination shows tachycardia, cyanosis, and hypotension. Some 5% of patients with no history of cancer who have a diagnosis of deep vein thrombosis or pulmonary embolism will have a diagnosis of cancer within 1 year. The most common cancers associated with thromboembolic episodes include lung, pancreatic, gastrointestinal, breast, ovarian, and genitourinary cancers, lymphomas, and brain tumors. Patients with cancer who undergo surgical procedures requiring general anesthesia have a 20–30% risk of deep vein thrombosis.

### Diagnosis

The diagnosis of deep vein thrombosis in patients with cancer is made by impedance plethysmography or bilateral compression ultrasonography of the leg veins. Patients with a noncompressible vein segment have deep vein thrombosis. If compression ultrasonography is normal and a high clinical suspicion exists for deep vein thrombosis, venography should be done to look for a luminal filling defect. Elevation of D-dimer is not as predictive of deep vein thrombosis in patients with cancer as it is in patients without cancer.

Patients with symptoms and signs suggesting a pulmonary embolism should be evaluated with a chest radiograph, electrocardiogram, arterial blood gas analysis, and ventilation–perfusion scan. Patients with mismatched segmental perfusion defects have a pulmonary embolus. Patients with equivocal ventilation–perfusion findings should be evaluated as already described for deep vein thrombosis in their legs. If deep vein thrombosis is detected, they should be anticoagulated. If deep vein thrombosis is not detected, they should be considered for a pulmonary angiogram.

Patients without a diagnosis of cancer who present with an initial episode of thrombophlebitis or pulmonary embolus need no additional tests for cancer other than a careful history and physical examination. In light of the many possible primary sites, diagnostic testing in asymptomatic patients is wasteful. However, if the clot is refractory to standard treatment or is in an unusual site, or if the thrombophlebitis is migratory or recurrent, efforts to find an underlying cancer are indicated.

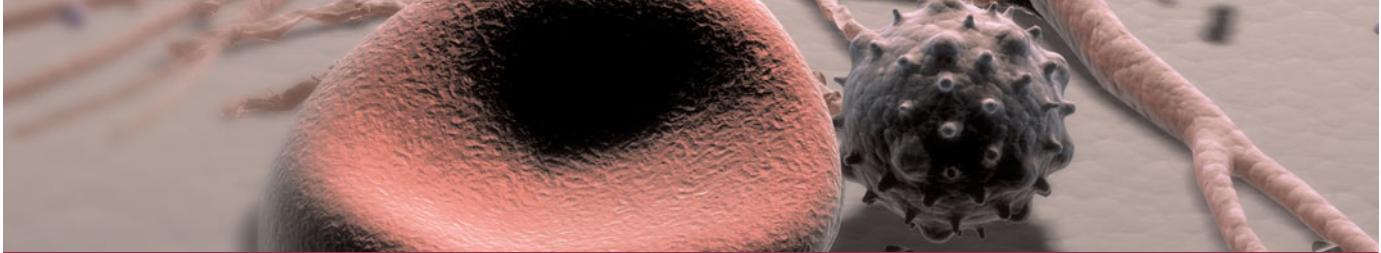
### **R<sub>x</sub>** Treatment: **THROMBOPHLEBITIS**

Patients with cancer and a diagnosis of deep vein thrombosis or pulmonary embolism should be treated initially with IV unfractionated heparin or low-molecular-weight heparin for at least 5 days and warfarin started within 1 or 2 days. The warfarin dose should be adjusted so the international normalized ratio (INR) is 2–3. Patients with proximal deep vein thrombosis and a relative contraindication to heparin anticoagulation (hemorrhagic brain metastases or pericardial effusion) should be considered for placement of a filter in the inferior vena cava (Greenfield filter) to prevent pulmonary embolism. Warfarin should be administered for 3–6 months. An alternative approach is to use low-molecular-weight heparin for 6 months. Patients with cancer who undergo a major surgical procedure should be considered for heparin prophylaxis or pneumatic boots. Breast cancer patients undergoing chemotherapy and patients with implanted catheters should be considered for prophylaxis (1 mg/d warfarin).

Neurologic paraneoplastic syndromes are discussed in Chap. 50.

### FURTHER READINGS

- AL-TOURAH AJ et al: Paraneoplastic erythropoietin-induced polycythemia associated with small lymphocytic lymphoma. *J Clin Oncol* 24:2388, 2006
- DELELLIS RA, XIA L: Paraneoplastic endocrine syndromes: A review. *Endocr Pathol* 14:303, 2003
- DONATI MB: Thrombosis and cancer. Trousseau syndrome revisited. *Best Pract Res Clin Haematol* 22:3, 2009
- EMEL EA et al: Sensitivity of fibroblast growth factor 23 measurements in tumor-induced osteomalacia. *J Clin Endocrinol Metab* 91:2055, 2006
- GABRILOVICH M et al: Paraneoplastic polymyositis associated with squamous cell carcinoma of the lung. *Chest* 129(6):1721, 2006
- HANSEN O et al: The occurrence of hyponatremia in SCLC and the influence on prognosis. A retrospective study of 453 patients treated in a single institution in a 10-year period. *Lung Cancer* 2009; June 15 (Epub ahead of print)
- JAN DE BEUR SM: Tumor-induced osteomalacia. *JAMA* 294:1260, 2005
- JONES PA, BAYLIN SB: The fundamental role of epigenetic events in cancer. *Nat Rev Genet* 3:415, 2002
- STEWART AF: Clinical practice. Hypercalcemia associated with cancer. *N Engl J Med* 352:373, 2005



## CHAPTER 50

# PARANEOPLASTIC NEUROLOGIC SYNDROMES

Josep Dalmau ■ Myrna R. Rosenfeld

Pathogenesis . . . . .	.631	Paraneoplastic Sensory Neuropathy or Dorsal Root Ganglionopathy . . . . .	.637
■ Specific Paraneoplastic Neurologic Syndromes . . . . .	.634	Paraneoplastic Peripheral Neuropathies . . . . .	.638
Paraneoplastic Encephalomyelitis and Focal Encephalitis . . . . .	.634	Acute Necrotizing Myopathy . . . . .	.638
Paraneoplastic Cerebellar Degeneration . . . . .	.636	Paraneoplastic Visual Syndromes . . . . .	.639
Paraneoplastic Opsoclonus-Myoclonus Syndrome . . . . .	.636	■ Further Readings . . . . .	.639
Paraneoplastic Syndromes of the Spinal Cord . . . . .	.637		
Paraneoplastic Stiff-Person Syndrome . . . . .	.637		

Paraneoplastic neurologic disorders (PNDs) are cancer-related syndromes that can affect any part of the nervous system (Table 50-1). They are remote effects of cancer, caused by mechanisms other than metastasis or by any of the complications of cancer such as coagulopathy, stroke, metabolic and nutritional conditions, infections, and side effects of cancer therapy. In 60% of patients the neurologic symptoms precede the cancer diagnosis. Overall, clinically disabling PNDs occur in 0.5–1% of all cancer patients, but they occur in 2–3% of patients with neuroblastoma or small cell lung cancer (SCLC), and in 30–50% of patients with thymoma or sclerotic myeloma.

### PATHOGENESIS

Most PNDs are mediated by immune responses triggered by neuronal proteins (onconeural antigens) expressed by tumors. In PNDs of the central nervous system (CNS), many antibody-associated immune responses have been identified (Table 50-2). These antibodies usually react with the patient's tumor, and their detection in serum or cerebrospinal fluid (CSF) strongly predicts the presence of cancer. The target antigens are usually intracellular proteins with roles in neuronal development and function. Some of the antibodies react with epitopes located in critical protein domains, disrupting protein

function and leading to neuronal apoptosis. In addition to onconeural antibodies, most PNDs of the CNS are associated with infiltrates of CD4+ and CD8+ T cells, microglial activation, gliosis, and variable neuronal loss. The infiltrating T cells are often in close contact with neurons undergoing degeneration, suggesting a primary pathogenic role. T cell-mediated cytotoxicity may contribute directly to cell death in these PNDs. Thus both humoral and cellular immune mechanisms participate in the pathogenesis of many PNDs. This complex immunopathogenesis may underlie the resistance of many of these conditions to therapy.

Neuronal cell-surface antigens can be the target of antibodies in some patients with paraneoplastic encephalitis. A few of these antigens have been identified, including the NR1/NR2 subunits of NMDA receptors (Fig. 50-1) and voltage-gated potassium channels (VGKCs). These disorders are more responsive to immunotherapy than those associated with immune responses to intracellular antigens.

Only four of the antibodies listed in Table 50-2 have been shown to play a direct pathogenic role in PNDs; all produce distinctive disorders of the peripheral nervous system. These are antibodies to P/Q-type voltage-gated calcium channels (VGCCs) in patients with the Lambert-Eaton myasthenic syndrome (LEMS); antibodies to acetylcholine receptors in patients with myasthenia



## PARANEOPLASTIC SYNDROMES OF THE NERVOUS SYSTEM

Syndromes of the brain, brainstem, and cerebellum
Focal encephalitis
Cortical encephalitis
Limbic encephalitis
Brainstem encephalitis
Cerebellar dysfunction
Autonomic dysfunction
Paraneoplastic cerebellar degeneration
Opsoclonus-myoclonus
Syndromes of the spinal cord
Subacute necrotizing myelopathy
Motor neuron dysfunction
Myelitis
Stiff-person syndrome
Syndromes of dorsal root ganglia
Sensory neuronopathy
Multiple levels of involvement
Encephalomyelitis, <sup>a</sup> sensory neuronopathy, autonomic dysfunction
Syndromes of peripheral nerve
Chronic and subacute sensorimotor peripheral neuropathy
Vasculitis of nerve and muscle
Neuropathy associated with malignant monoclonal gammopathies
Peripheral nerve hyperexcitability
Autonomic neuropathy
Syndromes of the neuromuscular junction
Lambert-Eaton myasthenic syndrome
Myasthenia gravis
Syndromes of the muscle
Polymyositis/dermatomyositis
Acute necrotizing myopathy
Syndromes affecting the visual system
Cancer-associated retinopathy (CAR)
Melanoma-associated retinopathy (MAR)
Uveitis (usually in association with encephalomyelitis)

<sup>a</sup>Includes cortical, limbic, or brainstem encephalitis, cerebellar dysfunction, myelitis.

gravis; antibodies to VGKC in some patients with peripheral nerve hyperexcitability (neuromyotonia); and antibodies to ganglionic acetylcholine receptors in some patients with autonomic neuropathy. Common features of these four antibodies are that they target cell-surface molecules and that their passive transfer to animals reproduces the disorders. Plasma exchange or immunomodulation with intravenous immunoglobulin (IVIg) usually produces neurologic improvement. Each of these disorders can occur without cancer, and therefore detection of these antibodies does not predict the presence of cancer.

Other PNDs are likely immune-mediated, although their antigens are unknown. These include several syndromes of inflammatory neuropathies and myopathies. In addition, many patients with typical PND syndromes are antibody-negative.

For still other PNDs, the cause remains quite obscure. These include, among others, several neuropathies that occur in the terminal stages of cancer and a number of neuropathies associated with plasma cell dyscrasias or lymphoma without evidence of inflammatory infiltrates or deposits of immunoglobulin, cryoglobulin, or amyloid.

### Approach to the Patient: PARANEOPLASTIC NEUROLOGIC DISORDERS

The diagnosis and management of PNDs may be difficult for several reasons. First, it is common for symptoms to appear before the presence of a tumor is known. Second, the neurologic syndrome can evolve in a rapidly progressive fashion, producing a severe and usually irreversible neurologic deficit in a short period of time. There is evidence that prompt tumor control improves the course of PNDs. Therefore, the major concern of the physician is to recognize a disorder promptly as paraneoplastic in order to identify and treat the tumor.

#### PND OF THE CENTRAL NERVOUS SYSTEM AND DORSAL ROOT GANGLIA

When symptoms involve brain, spinal cord, or dorsal root ganglia, the suspicion of PND is usually based on a combination of clinical, radiologic, and CSF findings. In these cases, a biopsy of the affected tissue is often difficult to obtain, and although useful to rule out other disorders (e.g., metastasis, infection), neuropathologic findings are not specific for PND. Furthermore, there are no specific radiologic or electrophysiologic tests that are diagnostic of PND. The presence of antineuronal antibodies (Table 50-2) may help in the diagnosis with the following caveats: (1) antibodies are detected in only 60–70% of PNDs of the CNS; (2) antibodies may be present in both the serum and CSF, but in some patients only the CSF is positive (especially with antibodies to Tr and Ma proteins); (3) antibodies (usually at low titer) are present in a variable proportion of cancer patients without PND; (4) there is an imperfect correlation between antibody titers and the course of the neurologic disorder; (5) several antibodies may associate with a similar syndrome, with the antibody specificity often correlating with the tumor type (e.g., cerebellar degeneration is associated with anti-Tr antibodies if the tumor is Hodgkin's disease but with anti-Yo antibodies if the tumor is ovarian or breast cancer); and (6) several antibodies may be present in the serum or CSF of the same patient (e.g., anti-Hu and anti-CV<sub>2</sub>/CRMP5).

MRI and CSF studies are important to rule out neurologic complications due to the direct spread of cancer, particularly metastatic and leptomeningeal disease. In most PNDs the MRI findings are nonspecific. Paraneoplastic limbic encephalitis is usually associated

TABLE 50-2

## PARANEOPLASTIC ANTINEURONAL ANTIBODIES, ASSOCIATED SYNDROMES AND CANCERS

ANTIBODY	SYNDROME	ASSOCIATED CANCERS
Anti-Hu (ANNA-1)	PEM (including cortical, limbic, brainstem encephalitis, cerebellar dysfunction, myelitis), PSN, autonomic dysfunction	SCLC, other neuroendocrine tumors
Anti-Yo (PCA-1)	PCD	Ovary and other gynecologic cancers, breast
Anti-Ri (ANNA-2)	PCD, brainstem encephalitis, opsoclonus-myoclonus	Breast, gynecologic, SCLC
Anti-Tr	PCD	Hodgkin's lymphoma
Anti-Zic	PCD, encephalomyelitis	SCLC and other neuroendocrine tumors
Anti-CV <sub>2</sub> /CRMP5	PEM, PCD, chorea, peripheral neuropathy, uveitis	SCLC, thymoma, other
Anti-Ma proteins <sup>a</sup>	Limbic, hypothalamic, brainstem encephalitis (infrequently PCD)	Germ-cell tumors of testis, lung cancer, other solid tumors
Anti-NR1/NR2 subunits of NMDA receptor	Encephalitis with prominent psychiatric symptoms, seizures, hypoventilation	Ovarian teratoma
Anti-amphiphysin	Stiff-person syndrome, PEM	Breast, SCLC
Anti-VGCC <sup>b</sup>	LEMS, PCD	SCLC, lymphoma
Anti-AChR <sup>b</sup>	MG	Thymoma
Anti-VGKC <sup>b</sup>	Peripheral nerve hyperexcitability (neuromyotonia), limbic encephalitis	Thymoma, SCLC, others
Anti-recoverin	Cancer-associated retinopathy (CAR)	SCLC and other
Anti-bipolar cells of the retina	Melanoma-associated retinopathy (MAR)	Melanoma

<sup>a</sup>Patients with antibodies to Ma2 are usually men with testicular cancer. Patients with additional antibodies to other Ma proteins are men or women with a variety of solid tumors.

<sup>b</sup>These antibodies can occur with or without a cancer association.

**Note:** PEM: paraneoplastic encephalomyelitis; PCD, paraneoplastic cerebellar degeneration; PSN, paraneoplastic sensory neuronopathy; LEMS, Lambert-Eaton myasthenic syndrome; MG, myasthenia gravis; VGCC, voltage-gated calcium channel; AChR, acetylcholine receptor; VGKC, voltage-gated potassium channel; SCLC, small-cell lung cancer; NMDA, *N*-methyl-D-aspartate.

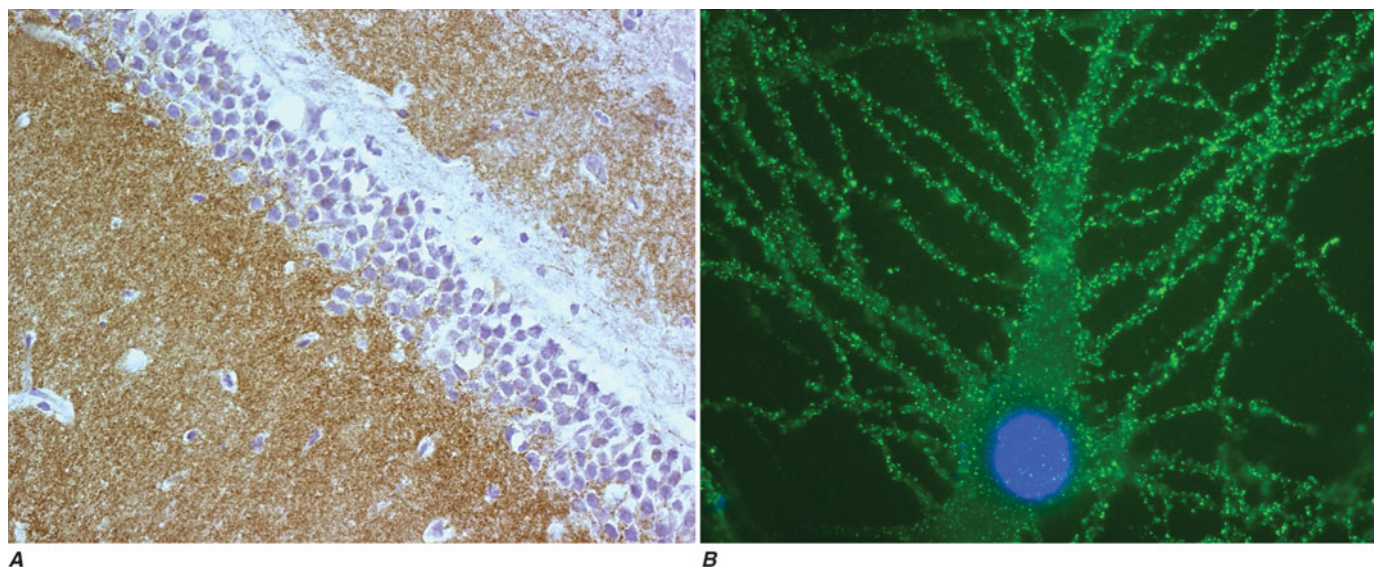
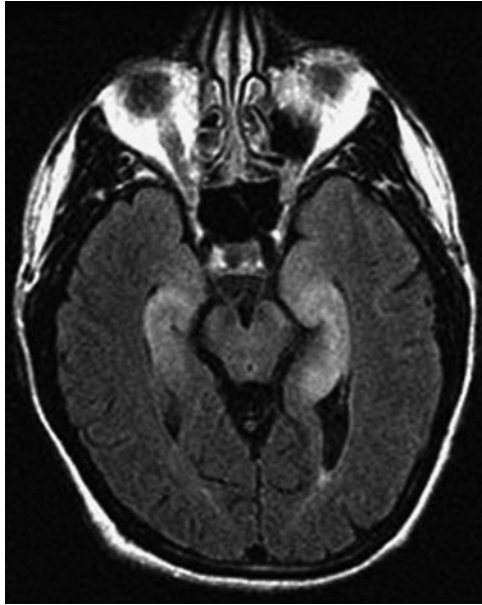


FIGURE 50-1

**Antibodies to NR1/NR2 subunits of the NMDA receptor** in a patient with paraneoplastic encephalitis and ovarian teratoma. **Panel A** is a section of dentate gyrus of rat hippocampus immunolabeled (brown staining) with the patient's antibodies. The reactivity predominates in the molecular

layer, which is highly enriched in dendritic processes. **Panel B** shows the antibody reactivity with cultures of rat hippocampal neurons; the intense green immunolabeling is due to the antibodies against the NR1/NR2 subunits of NMDA receptors.



**FIGURE 50-2**

Fluid-attenuated inversion recovery sequence MRI of a patient with limbic encephalitis and voltage-gated potassium channel antibodies. Note the abnormal hyperintensity involving the medial aspect of the temporal lobes.

with characteristic MRI abnormalities in the mesial temporal lobes (see later), but similar findings can occur with other disorders [e.g., nonparaneoplastic limbic encephalitis with antibodies to VGKC, human herpesvirus (HHV) 6 encephalitis] (Fig. 50-2). The CSF profile of patients with PND of the CNS or dorsal root ganglia typically consists of mild to moderate pleocytosis (<200 mononuclear cells, predominantly lymphocytes), an increase in the protein concentration, intrathecal synthesis of IgG, and a variable presence of oligoclonal bands.

**PND OF NERVE AND MUSCLE** If symptoms involve peripheral nerve, neuromuscular junction, or muscle, the diagnosis of a specific PND is usually established on clinical, electrophysiologic, and pathologic grounds. The clinical history, accompanying symptoms (e.g., anorexia, weight loss), and type of syndrome dictate the studies and degree of effort needed to demonstrate a neoplasm. For example, the frequent association of LEMS with SCLC should lead to a chest and abdomen CT or body positron emission tomography (PET) scan and, if negative, periodic tumor screening for at least 3 years after the neurologic diagnosis. In contrast, the weak association of polymyositis with cancer calls into question the need for repeated cancer screenings in this situation. Serum and urine immunofixation studies should be considered in patients with peripheral neuropathy of unknown cause; detection of a monoclonal gammopathy suggests the need for additional studies to

uncover a B cell or plasma cell malignancy. In paraneoplastic neuropathies, diagnostically useful antineuronal antibodies are limited to anti-CV<sub>2</sub>/CRMP5 and anti-Hu.

For any type of PND, if antineuronal antibodies are negative, the diagnosis relies on the demonstration of cancer and the exclusion of other cancer-related or independent neurologic disorders. Body PET scans often uncover tumors undetected by other tests.

## SPECIFIC PARANEOPLASTIC NEUROLOGIC SYNDROMES

(Table 50-3)

### PARANEOPLASTIC ENCEPHALOMYELITIS AND FOCAL ENCEPHALITIS

The term *encephalomyelitis* describes an inflammatory process with multifocal involvement of the nervous system, including brain, brainstem, cerebellum, and spinal cord. It is often associated with dorsal root ganglia and autonomic dysfunction. For any given patient, the clinical manifestations are determined by the area or areas predominantly involved, but pathology almost always reveals abnormalities (inflammatory infiltrates, neuronal loss, gliosis) beyond the symptomatic regions. Several clinicopathologic syndromes may occur alone or in combination: (1) *cortical encephalitis*, which may present as “epilepsia partialis continua”; (2) *limbic encephalitis*, characterized by confusion, depression, agitation, anxiety, severe short-term memory deficits, partial complex seizures, and dementia; the MRI usually shows unilateral or bilateral medial temporal lobe abnormalities, best seen with T2 and fluid-attenuated inversion recovery sequences, and occasionally enhancing with gadolinium; (3) *brainstem encephalitis*, resulting in eye movement disorders (nystagmus, opsoclonus, supranuclear or nuclear paresis), cranial nerve paresis, dysarthria, dysphagia, and central autonomic dysfunction; (4) *cerebellar gait and limb ataxia*; (5) *myelitis*, which may cause lower or upper motor neuron symptoms, myoclonus, muscle rigidity, and spasms; and (6) *autonomic dysfunction* as a result of involvement of the neuraxis at multiple levels, including hypothalamus, brainstem, and autonomic nerves (see autonomic neuropathy). Cardiac arrhythmias, postural hypotension, or central hypoventilation are frequent causes of death in patients with encephalomyelitis.

Paraneoplastic encephalomyelitis and focal encephalitis are usually associated with SCLC, but many other cancers have also been reported. Patients with SCLC and these syndromes usually have anti-Hu antibodies in serum and CSF. Anti-CV<sub>2</sub>/CRMP5 antibodies occur less frequently; some of these patients may develop

TABLE 50-3

ANTIBODY-ASSOCIATED PARANEOPLASTIC AND NONPARANEOPLASTIC SYNDROMES<sup>a</sup>

SYNDROME	ANTIBODIES		
	PARANEOPLASTIC		
	FREQUENT	INFREQUENT	NONPARANEOPLASTIC
Limbic encephalitis	Ma2, Hu, CV <sub>2</sub> /CRMP5, <i>anti-NR1/NR2 of NMDA receptor</i>	Tr, VGKC	VGKC
Cerebellar degeneration	Yo, Tr, P/Q VGCC, Hu, Zic, Ri, CV <sub>2</sub> /CRMP5, Ma1-2	<i>mGluR1</i> ; MAZ	Gliadin, GAD
Hypothalamic, brainstem encephalitis	Ma2, Hu	CV <sub>2</sub> /CRMP5	
Encephalomyelitis	Hu, Zic	CV <sub>2</sub> /CRMP5, Ri, amphiphysin	
Chorea	CV <sub>2</sub> /CRMP5		
Opsoclonus-myoclonus	Ri	Hu, Ma2, Yo, <i>Gephyrin</i> , Ri	GAD
Stiff-person syndrome	Amphiphysin		VGKC
PNH (neuromyotonia)	VGKC		AChR, MuSK
Myasthenia gravis	AChR		P/Q-type VGCC
LEMS	P/Q-type VGCC	<i>MysB</i>	
Sensory neuropathy	Hu		
Axonal sensorimotor neuropathy	Hu, CV <sub>2</sub> /CRMP5		Monoclonal gammopathy (M protein) <sup>b</sup>
Autonomic neuropathy	Hu	CV <sub>2</sub> /CRMP5, ganglionic AChR	Ganglionic AChR
Predominant sensory demyelinating neuropathy		MAG, ganglioside antibodies: often present with Waldenström's macroglobulinemia	MAG, ganglioside antibodies, often present with MGUS
Paraneoplastic retinopathy	Recoverin (CAR), anti-bipolar cell antibodies (MAR), <i>anti-enolase</i>	<i>Tubby-like protein 1</i> , PNR	<i>Anti-enolase</i>

<sup>a</sup>Antibodies have been validated by more than one laboratory and/or the protein sequence of the target antigen is known.

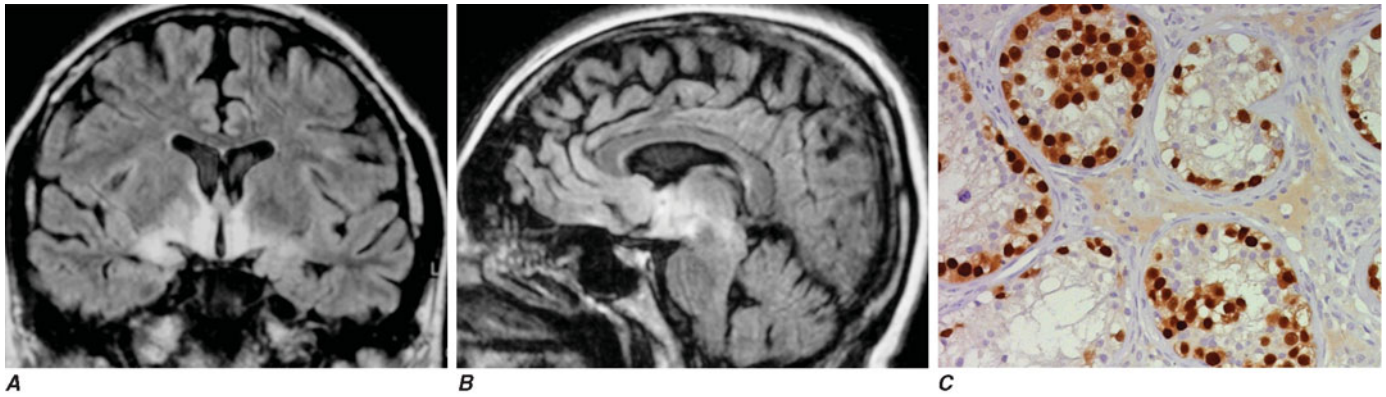
<sup>b</sup>The M protein usually does not have specific antibody activity.

**Note:** *Italics* indicate that commercial testing for these antibodies is not available. PNH, peripheral nerve hyperexcitability; CAR, cancer-associated retinopathy; MAR, melanoma-associated retinopathy; PNR, photoreceptor-specific nuclear receptor; MGUS, monoclonal gammopathy of uncertain significance; VGKC, voltage-gated potassium channel; GAD, glutamic acid decarboxylase; AChR, acetylcholine receptor; LEMS, Lambert-Eaton myasthenic syndrome; VGCC, voltage-gated calcium channel; MAG, myelin-associated glycoprotein; NMDA, *N*-methyl-D-aspartate.

chorea or uveitis. Antibodies to Ma proteins are associated with limbic, hypothalamic, and brainstem encephalitis and occasionally with cerebellar symptoms (Fig. 50-3); some patients develop hypersomnia, catalepsy, and severe hypokinesia. MRI abnormalities are frequent, including those described with limbic encephalitis and variable involvement of the hypothalamus, basal ganglia, or upper brainstem. Antibodies to NR1/NR2 subunits of the NMDA receptor associate with a severe, potentially lethal, but treatment-responsive encephalitis. The affected patients are young women who develop combinations of psychiatric symptoms, seizures, dyskinesias, stupor, and hypoventilation. The oncologic associations of these antibodies are shown in Table 50-2.

### **Rx** Treatment: ENCEPHALITIS AND ENCEPHALOMYELITIS

Most types of paraneoplastic encephalitis and encephalomyelitis respond poorly to treatment. Stabilization of symptoms or partial neurologic improvement may occasionally occur, particularly if there is a satisfactory response of the tumor to treatment. The roles of plasma exchange, IVIg, and immunosuppression have not been established. Approximately 30% of patients with anti-Ma2-associated encephalitis respond to treatment of the tumor (usually a germ-cell neoplasm of the testis) and immunotherapy. Two other syndromes that are responsive to treatment of the tumor and



**FIGURE 50-3**

**MRI and tumor of a patient** with anti-Ma2-associated encephalitis. **Panels A** and **B** are fluid-attenuated inversion recovery MRI sequences showing abnormal hyperintensities in the medial temporal lobes, hypothalamus and upper

brainstem. **Panel C** corresponds to a section of the patient's orchietomy incubated with a specific marker (Oct4) of germ-cell tumors. The positive (brown) cells correspond to an intratubular germ-cell neoplasm.

immunotherapy are the encephalitis that associates with antibodies to the NR1/NR2 subunits of NMDA receptors in patients with teratoma of the ovary, and the encephalitis that associates with VGKC antibodies in some patients with thymoma or SCLC.

## PARANEOPLASTIC CEREBELLAR DEGENERATION

This disorder is often preceded by a prodrome that may include dizziness, oscillopsia, blurry or double vision, nausea, and vomiting. A few days or weeks later, dysarthria, gait and limb ataxia, and variable dysphagia can appear. The examination usually shows downbeating nystagmus and, rarely, opsoclonus. Brainstem dysfunction, upgoing toes, or a mild neuropathy may occur, but more often the symptoms and signs are restricted to the cerebellum. Early in the course, MRI studies are usually normal; later, the MRI typically reveals cerebellar atrophy. The disorder results from extensive degeneration of Purkinje cells, with variable involvement of other cerebellar cortical neurons, deep cerebellar nuclei, and spinocerebellar tracts. The tumors more frequently involved are SCLC, cancer of the breast and ovary, and Hodgkin's lymphoma.

Anti-Yo antibodies in patients with breast and gynecologic cancers and anti-Tr antibodies in patients with Hodgkin's lymphoma are the two paraneoplastic antibodies typically associated with prominent or pure cerebellar degeneration. Antibodies to P/Q-type VGCC occur in some patients with SCLC and cerebellar dysfunction; only some of these patients develop LEMS. Of note, a variable degree of cerebellar dysfunction can be associated with virtually any type of antibody-related PND of the CNS (Table 50-2).

## Rx Treatment: CEREBELLAR DEGENERATION

A number of single case reports have described neurologic improvement after tumor removal, plasma exchange, IVIg, cyclophosphamide, rituximab, or glucocorticoids. However, large series of patients with antibody-positive paraneoplastic cerebellar degeneration show that this disorder rarely improves with any treatment.

## PARANEOPLASTIC OPSOCLONUS-MYOCLONUS SYNDROME

*Opsoclonus* is a disorder of eye movement characterized by involuntary, chaotic saccades that occur in all directions of gaze; it is frequently associated with myoclonus and ataxia. Opsoclonus-myoclonus may be cancer-related or idiopathic. When the cause is paraneoplastic, the tumors involved are usually cancer of the lung and breast in adults and neuroblastoma in children. The pathologic substrate of opsoclonus-myoclonus is unclear. Most SCLC patients do not have detectable antineuronal antibodies. A small subset of patients with ataxia, opsoclonus, and other eye movement disorders develop anti-Ri antibodies; in rare instances muscle rigidity, autonomic dysfunction, and dementia also occur. The tumor most frequently involved in anti-Ri-associated syndromes is breast cancer.

If the tumor is not successfully treated, the paraneoplastic opsoclonus-myoclonus syndrome in adults often progresses to encephalopathy, coma, and death. In addition to treating the tumor, symptoms may respond to immunotherapy (glucocorticoids, plasma exchange, and/or IVIg).

At least 50% of children with opsoclonus–myoclonus have an underlying neuroblastoma. Hypotonia, ataxia, behavioral changes, and irritability are frequent accompanying symptoms. Many patients harbor antibodies to neuronal cell surface antigens of unknown identity. Neurologic symptoms often improve with treatment of the tumor (including chemotherapy) and with glucocorticoids, adrenocorticotropic hormone (ACTH), plasma exchange, IVIg, and rituximab. Many patients are left with psychomotor retardation and behavioral and sleep problems.

## PARANEOPLASTIC SYNDROMES OF THE SPINAL CORD

The number of reports of paraneoplastic spinal cord syndromes, such as *subacute motor neuronopathy* and *acute necrotizing myelopathy*, has decreased in recent years. This may represent a true decrease in incidence, due to improved and prompt oncologic interventions, or may be because of the identification of nonparaneoplastic etiologies.

Some patients with cancer develop *upper* or *lower motor neuron dysfunction* or both, resembling amyotrophic lateral sclerosis. It is unclear whether these disorders have a paraneoplastic etiology or simply coincide with the presence of cancer. There are isolated case reports of cancer patients with motor neuron dysfunction who had neurologic improvement after tumor treatment. A more than coincidental association occurs between lymphoma and motor neuron dysfunction. A search for lymphoma should be undertaken in patients with a motor neuron syndrome who are found to have a monoclonal protein in serum or CSF.

*Paraneoplastic myelitis* may present with upper or lower motor neuron symptoms, segmental myoclonus, and rigidity. This syndrome can appear as the presenting manifestation of encephalomyelitis and may be associated with SCLC and serum anti-Hu, anti-CV<sub>2</sub>/CRMP5, or anti-amphiphysin antibodies.

Paraneoplastic myelopathy can also produce several syndromes characterized by prominent muscle stiffness and rigidity. The spectrum ranges from focal symptoms in one or several extremities (*stiff-limb syndrome* or *stiff-person syndrome*) to a disorder that also affects the brainstem (known as *encephalomyelitis with rigidity*) and likely has a different pathogenesis.

## PARANEOPLASTIC STIFF-PERSON SYNDROME

This disorder is characterized by progressive muscle rigidity, stiffness, and painful spasms triggered by auditory, sensory, or emotional stimuli. Rigidity mainly involves the lower trunk and legs, but it can affect the upper extremities and neck. Symptoms improve with sleep and general anesthetics. Electrophysiologic studies

demonstrate continuous motor unit activity. Antibodies associated with the stiff-person syndrome target proteins [glutamic acid decarboxylase (GAD), amphiphysin] involved in the function of inhibitory synapses utilizing  $\gamma$ -aminobutyric acid (GABA) or glycine as neurotransmitters. Paraneoplastic stiff-person syndrome and amphiphysin antibodies are often related to breast cancer. By contrast, antibodies to GAD may occur in some cancer patients but are much more frequently present in the nonparaneoplastic disorder.

### **R<sub>x</sub> Treatment:** **STIFF-PERSON SYNDROME**

Optimal treatment of stiff-person syndrome requires therapy of the underlying tumor, glucocorticoids, and symptomatic use of drugs that enhance GABA-ergic transmission (diazepam, baclofen, sodium valproate, tiagabine, vigabatrin). A benefit of IVIg has been demonstrated for the nonparaneoplastic disorder but remains to be established for the paraneoplastic syndrome.

## PARANEOPLASTIC SENSORY NEURONOPATHY OR DORSAL ROOT GANGLIONOPATHY

This syndrome is characterized by sensory deficits that may be symmetric or asymmetric, painful dysesthesias, radicular pain, and decreased or absent reflexes. All modalities of sensation and any part of the body including face and trunk can be involved. Specialized sensations such as taste and hearing can also be affected. Electrophysiologic studies show decreased or absent sensory nerve potentials with normal or near-normal motor conduction velocities. Symptoms result from an inflammatory, likely immune-mediated, process that targets the dorsal root ganglia, causing neuronal loss, proliferation of satellite cells, and secondary degeneration of the posterior columns of the spinal cord. The dorsal nerve roots, and less frequently the anterior nerve roots and peripheral nerves, may also be involved.

### **R<sub>x</sub> Treatment:** **SENSORY NEUROPATHY**

This disorder often precedes or is associated with encephalomyelitis and autonomic dysfunction and has the same immunologic and oncologic associations, e.g., anti-Hu antibodies and SCLC. As with anti-Hu-associated encephalomyelitis, the therapeutic approach focuses on prompt treatment of the tumor. Glucocorticoids occasionally produce clinical stabilization or improvement. The benefit of IVIg and plasma exchange is not proved.

These disorders may develop any time during the course of the neoplastic disease. Neuropathies occurring at late stages of cancer or lymphoma usually cause mild to moderate sensorimotor deficits due to axonal degeneration of unclear etiology. These neuropathies are often masked by concurrent neurotoxicity from chemotherapy and other cancer therapies. In contrast, the neuropathies that develop in the early stages of cancer often show a rapid progression, sometimes with a relapsing and remitting course, and evidence of inflammatory infiltrates and axonal loss or demyelination in biopsy studies. If demyelinating features predominate, IVIg or glucocorticoids may improve symptoms. Occasionally anti-CV<sub>2</sub>/CRMP5 antibodies are present; detection of anti-Hu suggests concurrent dorsal root ganglionitis.

*Guillain-Barré syndrome* and *brachial plexitis* have occasionally been reported in patients with lymphoma, but there is no clear evidence of a paraneoplastic association.

*Malignant monoclonal gammopathies* include: (1) multiple myeloma and sclerotic myeloma associated with IgG or IgA monoclonal proteins; and (2) Waldenström's macroglobulinemia, B cell lymphoma, and chronic B cell lymphocytic leukemia associated with IgM monoclonal proteins. These disorders may cause neuropathy by a variety of mechanisms, including compression of roots and plexuses by metastasis to vertebral bodies and pelvis, deposits of amyloid in peripheral nerves, and paraneoplastic mechanisms. The paraneoplastic variety has several distinctive features. Approximately half of patients with sclerotic myeloma develop a sensorimotor neuropathy with predominantly motor deficits, resembling a chronic inflammatory demyelinating neuropathy; some patients develop elements of the POEMS syndrome (*polyneuropathy, organomegaly, endocrinopathy, M protein, skin changes*). Treatment of the plasmacytoma or sclerotic lesions usually improves the neuropathy. In contrast, the sensorimotor or sensory neuropathy associated with multiple myeloma rarely responds to treatment. Between 5% and 10% of patients with Waldenström's macroglobulinemia develop a distal symmetric sensorimotor neuropathy with predominant involvement of large sensory fibers. These patients may have IgM antibodies in their serum against myelin-associated glycoprotein and various gangliosides. In addition to treating the Waldenström's macroglobulinemia, other therapies may improve the neuropathy, including plasma exchange, IVIg, chlorambucil, cyclophosphamide, fludarabine, or rituximab.

*Vasculitis of the nerve and muscle* causes a painful symmetric or asymmetric distal sensorimotor neuropathy with variable proximal weakness. It predominantly affects elderly men and is associated with an elevated erythrocyte sedimentation rate and increased CSF protein concentration. SCLC and lymphoma are the primary

tumors involved. Pathology demonstrates axonal degeneration and T cell infiltrates involving the small vessels of the nerve and muscle. Immunosuppressants (glucocorticoids and cyclophosphamide) often result in neurologic improvement.

*Peripheral nerve hyperexcitability (neuromyotonia, or Isaacs' syndrome)* is characterized by spontaneous and continuous muscle fiber activity of peripheral nerve origin. Clinical features include cramps, muscle twitching (fasciculations or myokymia), stiffness, delayed muscle relaxation (pseudomyotonia), and spontaneous or evoked carpal or pedal spasms. The involved muscles may be hypertrophic, and some patients develop paresthesias and hyperhydrosis. CNS dysfunction, including mood changes, sleep disorder, or hallucinations, may occur. The electromyogram (EMG) shows fibrillations; fasciculations; and doublet, triplet, or multiplet single unit (myokymic) discharges that have a high intraburst frequency. An immune pathogenesis is suggested by the frequent presence of serum antibodies to VGKC. The disorder often occurs without cancer; if paraneoplastic, benign and malignant thymomas and SCLC are the usual tumors. Phenytoin, carbamazepine, and plasma exchange improve symptoms.

*Paraneoplastic autonomic neuropathy* usually develops as a component of other disorders, such as LEMS and encephalomyelitis. It may rarely occur as a pure or predominantly autonomic neuropathy with adrenergic or cholinergic dysfunction at the pre- or postganglionic levels. Patients can develop several life-threatening complications, such as gastrointestinal paresis with pseudoobstruction, cardiac dysrhythmias, and postural hypotension. Other symptoms include dry mouth, erectile dysfunction, anhidrosis, and sphincter dysfunction; abnormal pupillary responses may be found. The disorder has been reported to occur in association with several tumors, including SCLC, cancer of the pancreas or testis, carcinoid tumors, and lymphoma. Because autonomic symptoms can also be the presenting feature of encephalomyelitis, serum anti-Hu and anti-CV<sub>2</sub>/CRMP5 antibodies should also be sought. Serum antibodies to ganglionic acetylcholine receptors have been reported in this syndrome, but they also occur without a cancer association.

## **ACUTE NECROTIZING MYOPATHY**

Patients with this syndrome develop myalgias and rapid progression of weakness involving the extremities and the pharyngeal and respiratory muscles, often resulting in death. Serum muscle enzymes are elevated, and muscle biopsy shows extensive necrosis with minimal or absent inflammation and sometimes deposits of complement. The disorder occurs as a paraneoplastic manifestation of a variety of cancers including SCLC and cancer of the gastrointestinal tract, breast, kidney, and prostate, among others. Glucocorticoids or treatment of the underlying tumor rarely control the disorder.

## PARANEOPLASTIC VISUAL SYNDROMES

This group of disorders involves the retina and, less frequently, the uvea and optic nerves. The term *cancer-associated retinopathy* is used to describe paraneoplastic cone and rod dysfunction characterized by photosensitivity, progressive loss of vision and color perception, central or ring scotomas, night blindness, and attenuation of photopic and scotopic responses in the electroretinogram (ERG). The most commonly associated tumor is SCLC. Melanoma-associated retinopathy affects patients with metastatic cutaneous melanoma. Patients develop the acute onset of night blindness and shimmering, flickering, or pulsating photopsias that often progress to visual loss. The ERG demonstrates reduction in the b-wave amplitude. Paraneoplastic optic neuritis and uveitis are very uncommon and can develop in association with encephalomyelitis. Some patients with paraneoplastic uveitis harbor anti-CV<sub>2</sub>/CRMP5 antibodies.

Some paraneoplastic retinopathies are associated with serum antibodies that specifically react with the subset of retinal cells undergoing degeneration, supporting an immune-mediated pathogenesis (Tables 50-2 and 50-3). Paraneoplastic retinopathies usually fail to improve with treatment, although rare responses to glucocorticoids, plasma exchange, and IVIg have been reported.

## FURTHER READINGS

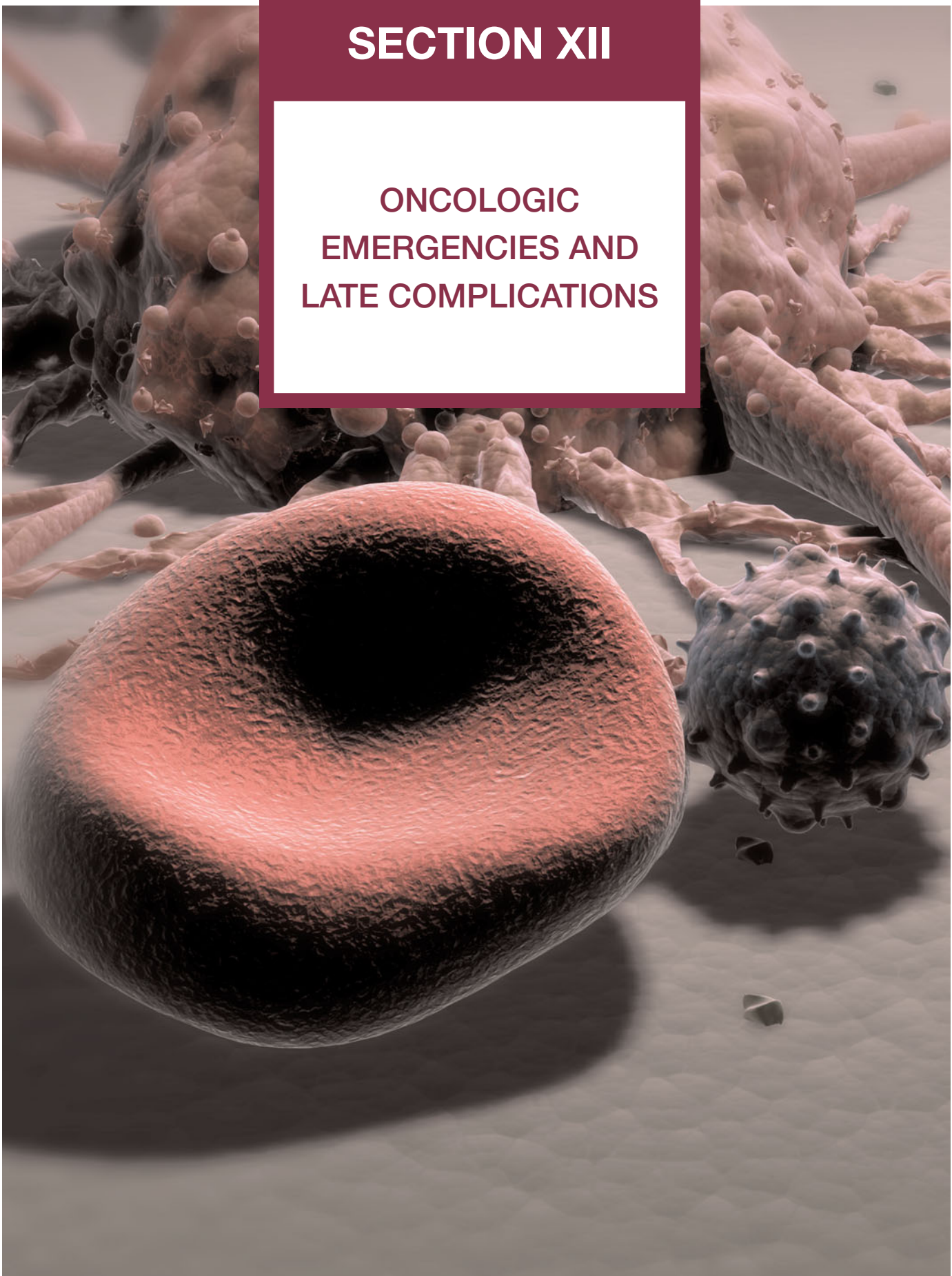
- ANTOINE JC, CAMDESSANCHÉ JP: Peripheral nervous system involvement in patients with cancer. *Lancet Neurol* 6:75, 2007
- BATALLER L et al: Autoimmune limbic encephalitis in 39 patients: Immunophenotypes and outcomes. *J Neurol Neurosurg Psychiatry* 78:381, 2007
- DALMAU J et al: Paraneoplastic anti-N-methyl-D-aspartate receptor encephalitis associated with ovarian teratoma. *Ann Neurol* 61:25, 2007
- DIDELOT A, HONNORAT J: Update on paraneoplastic neurological syndromes. *Curr Opin Oncol* 21:566, 2009
- MATHEW RM et al: Orchiectomy for suspected microscopic tumor in patients with anti-Ma2-associated encephalitis. *Neurology* 68:900, 2007
- MCKEON A et al: Ganglionic acetylcholine receptor autoantibody: Oncological, neurological, and serological accompaniments. *Arch Neurol* 66:735, 2009
- MEHTA SH et al: Paraneoplastic movement disorders. *Curr Neurol Neurosci Rep* 9:285, 2009
- NAYAK L, RUBIN M: Amphiphysin autoimmunity in paraneoplastic neurologic disease. *Clin Adv Hematol Oncol* 7:183, 2009
- ROSENFELD MR, DALMAU J: Current therapies for neuromuscular manifestations of paraneoplastic syndromes. *Curr Neurol Neurosci Rep* 6:77, 2006

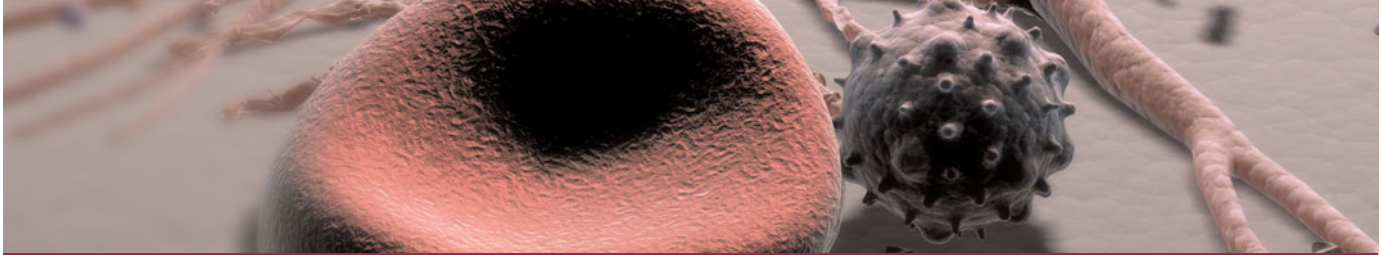


*This page intentionally left blank*

# SECTION XII

## ONCOLOGIC EMERGENCIES AND LATE COMPLICATIONS





## CHAPTER 51

# ONCOLOGIC EMERGENCIES

Rasim Gucalp ■ Janice P. Dutcher

■ Structural-Obstructive Oncologic Emergencies . . . . .	642	Syndrome of Inappropriate Secretion of Antidiuretic	
Superior Vena Cava Syndrome . . . . .	642	Hormone (SIADH) . . . . .	651
Pericardial Effusion/Tamponade . . . . .	643	Lactic Acidosis . . . . .	651
Intestinal Obstruction . . . . .	645	Hypoglycemia . . . . .	651
Urinary Obstruction . . . . .	645	Adrenal Insufficiency . . . . .	651
Malignant Biliary Obstruction . . . . .	645	■ Treatment-Related Emergencies . . . . .	652
Spinal Cord Compression . . . . .	646	Tumor Lysis Syndrome . . . . .	652
Increased Intracranial Pressure . . . . .	648	Human Antibody Infusion Reactions . . . . .	653
Neoplastic Meningitis . . . . .	648	Hemolytic-Uremic Syndrome . . . . .	653
Seizures . . . . .	649	Neutropenia and Infection . . . . .	654
Pulmonary and Intracerebral Leukocytostasis . . . . .	649	Pulmonary Infiltrates . . . . .	654
Hemoptysis . . . . .	650	Neutropenic Enterocolitis . . . . .	655
Airway Obstruction . . . . .	650	Hemorrhagic Cystitis . . . . .	656
■ Metabolic Emergencies . . . . .	651	Hypersensitivity Reactions to Antineoplastic Drugs . . . . .	656
Hypercalcemia . . . . .	651	■ Further Readings . . . . .	656

Emergencies in patients with cancer may be classified into three groups: pressure or obstruction caused by a space-occupying lesion, metabolic or hormonal problems (paraneoplastic syndromes; Chap. 49), and treatment-related complications.

### STRUCTURAL-OBSTRUCTIVE ONCOLOGIC EMERGENCIES

#### SUPERIOR VENA CAVA SYNDROME

Superior vena cava syndrome (SVCS) is the clinical manifestation of superior vena cava (SVC) obstruction, with severe reduction in venous return from the head, neck, and upper extremities. Malignant tumors, such as lung cancer, lymphoma, and metastatic tumors, are responsible for most SVCS cases. With the expanding use of intravascular devices (e.g., permanent central venous access catheters, pacemaker/defibrillator leads), the prevalence of benign causes of SVCS is increasing. Lung cancer, particularly of small cell and squamous cell histologies, accounts for ~85% of all cases of malignant

origin. In young adults, malignant lymphoma is a leading cause of SVCS. Hodgkin's lymphoma involves the mediastinum more commonly than other lymphomas but rarely causes SVCS. When SVCS is noted in a young man with a mediastinal mass, the differential diagnosis is lymphoma versus primary mediastinal germ cell tumor. Metastatic cancers to the mediastinum, such as testicular and breast carcinomas, account for a small proportion of cases. Other causes include benign tumors, aortic aneurysm, thyromegaly, thrombosis, and fibrosing mediastinitis from prior irradiation or histoplasmosis.

Patients with SVCS usually present with neck and facial swelling (especially around the eyes), dyspnea, and cough. Other symptoms include hoarseness, tongue swelling, headaches, nasal congestion, epistaxis, hemoptysis, dysphagia, pain, dizziness, syncope, and lethargy. Bending forward or lying down may aggravate the symptoms. The characteristic physical findings are dilated neck veins, an increased number of collateral veins covering the anterior chest wall, cyanosis, and edema of the face, arms, and chest. More severe cases include proptosis, glosal and laryngeal edema, and obtundation. The clinical

picture is milder if the obstruction is located above the azygos vein.

Signs and symptoms of cerebral and/or laryngeal edema, although rare, are associated with a poorer prognosis and require urgent evaluation. Seizures are more likely related to brain metastases than to cerebral edema from venous occlusion. Patients with small cell lung cancer and SVCS have a higher incidence of brain metastases than those without SVCS.

Cardiorespiratory symptoms at rest, particularly with positional changes, suggest significant airway and vascular obstruction and limited physiologic reserve. Cardiac arrest or respiratory failure can occur, particularly in patients receiving sedatives or undergoing general anesthesia.

The diagnosis of SVCS is a clinical one. The most significant chest radiographic finding is widening of the superior mediastinum, most commonly on the right side. Pleural effusion occurs in only 25% of patients, often on the right side. However, a normal chest radiograph is still compatible with the diagnosis if other characteristic findings are present. CT provides the most reliable view of the mediastinal anatomy. The diagnosis of SVCS requires diminished or absent opacification of central venous structures with prominent collateral venous circulation. MRI has no advantages over CT. Invasive procedures, including bronchoscopy, percutaneous needle biopsy, mediastinoscopy, and even thoracotomy, can be performed by a skilled clinician without any major risk of bleeding. For patients with a known cancer, a detailed workup usually is not necessary, and appropriate treatment may be started after obtaining a CT scan of the thorax. For those with no history of malignancy, a detailed evaluation is essential to rule out benign causes and determine a specific diagnosis to direct the appropriate therapy.

### **Rx Treatment:** **SUPERIOR VENA CAVA SYNDROME**

The one potentially life-threatening complication of a superior mediastinal mass is tracheal obstruction. Upper airway obstruction demands emergent therapy. Diuretics with a low-salt diet, head elevation, and oxygen may produce temporary symptomatic relief. Glucocorticoids may be useful at shrinking lymphoma masses; they are of no benefit in patients with lung cancer.

Radiation therapy is the primary treatment for SVCS caused by non-small cell lung cancer and other metastatic solid tumors. Chemotherapy is effective when the underlying cancer is small cell carcinoma of the lung, lymphoma, or germ cell tumor. SVCS recurs in 10–30% of patients; it may be palliated with the use of intravascular self-expanding stents (**Fig. 51-1**). Early stenting may be necessary in patients with severe symptoms; however, the prompt increase in venous return after stenting may precipitate heart failure and pulmonary edema. Surgery

may provide immediate relief for patients in whom a benign process is the cause.

Clinical improvement occurs in most patients, although this improvement may be due to the development of adequate collateral circulation. The mortality associated with SVCS does not relate to caval obstruction but rather to the underlying cause.

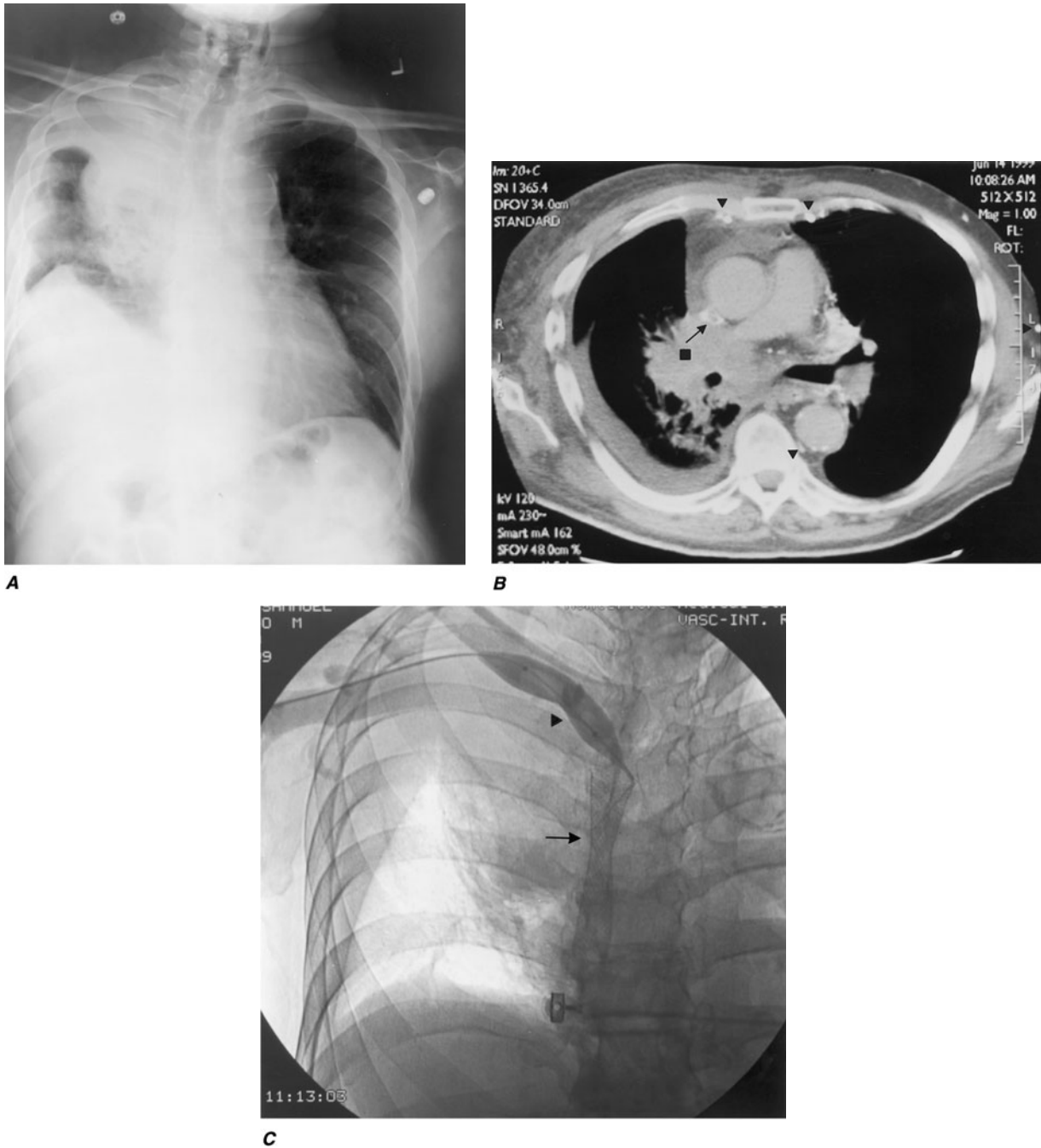
### **SVCS AND CENTRAL VENOUS CATHETERS IN ADULTS**

The use of long-term central venous catheters has become common practice in patients with cancer. Major vessel thrombosis may occur. In these cases, catheter removal should be combined with anticoagulation to prevent embolization. SVCS in this setting, if detected early, can be treated by fibrinolytic therapy without sacrificing the catheter. The routine use of low-dose warfarin or low-molecular-weight heparin to prevent thrombosis related to permanent central venous access catheters in cancer patients is not recommended.

## **PERICARDIAL EFFUSION/TAMPONADE**

Malignant pericardial disease is found at autopsy in 5–10% of patients with cancer, most frequently with lung cancer, breast cancer, leukemias, and lymphomas. Cardiac tamponade as the initial presentation of extrathoracic malignancy is rare. The origin is not malignancy in ~50% of cancer patients with symptomatic pericardial disease, but it can be related to irradiation, drug-induced pericarditis, hypothyroidism, idiopathic pericarditis, infection, or autoimmune diseases. Two types of radiation pericarditis occur: an acute inflammatory, effusive pericarditis occurring within months of irradiation, which usually resolves spontaneously, and a chronic effusive pericarditis that may appear up to 20 years after radiation therapy and is accompanied by a thickened pericardium.

Most patients with pericardial metastasis are asymptomatic. However, the common symptoms are dyspnea, cough, chest pain, orthopnea, and weakness. Pleural effusion, sinus tachycardia, jugular venous distension, hepatomegaly, peripheral edema, and cyanosis are the most frequent physical findings. Relatively specific diagnostic findings, such as paradoxical pulse, diminished heart sounds, pulsus alternans (pulse waves alternating between those of greater and lesser amplitude with successive beats), and friction rub are less common than with nonmalignant pericardial disease. Chest radiographs and ECG reveal abnormalities in 90% of patients, but half of these abnormalities are nonspecific. Echocardiography is the most helpful diagnostic test. Pericardial fluid may be serous, serosanguineous, or hemorrhagic, and cytologic examination of pericardial fluid is diagnostic in most patients. Cancer patients with pericardial effusion containing malignant cells on cytology have a very poor survival, ~7 weeks.



**FIGURE 51-1**

**Superior vena cava syndrome.** **A.** Chest radiographs of a 59-year-old man with recurrent SVCS caused by non-small cell lung cancer showing right paratracheal mass with right pleural effusion. **B.** CT of same patient demonstrating

obstruction of SVC with thrombosis (*arrow*) by the lung cancer (*square*) and collaterals (*arrowheads*). **C.** Balloon angioplasty (*arrowhead*) with Wallstent (*arrow*) in same patient.

**Rx Treatment:**  
**PERICARDIAL EFFUSION/TAMPONADE**

Pericardiocentesis with or without the introduction of sclerosing agents, the creation of a pericardial window, complete pericardial stripping, cardiac irradiation, or systemic chemotherapy are effective treatments. Acute pericardial tamponade with life-threatening hemodynamic instability requires immediate drainage of fluid. This can

be quickly achieved by pericardiocentesis. The recurrence rate after percutaneous catheter drainage is ~20%. Sclerotherapy (pericardial instillation of bleomycin, mitomycin C, or tetracycline) may decrease recurrences. Alternatively, subxiphoid pericardiotomy can be performed in 45 min under local anesthesia. Thoracoscopic pericardial fenestration can be employed for benign causes; however, 60% of malignant pericardial effusions recur after this procedure.

## INTESTINAL OBSTRUCTION

Intestinal obstruction and reobstruction are common problems in patients with advanced cancer, particularly colorectal or ovarian carcinoma. However, other cancers, such as lung or breast cancer and melanoma, can metastasize within the abdomen, leading to intestinal obstruction. Typically, obstruction occurs at multiple sites. Melanoma has a predilection to involve the small bowel; this involvement may be isolated and resection may result in prolonged survival. Intestinal pseudoobstruction is caused by infiltration of the mesentery or bowel muscle by tumor, involvement of the celiac plexus, or paraneoplastic neuropathy in patients with small cell lung cancer. Paraneoplastic neuropathy is associated with IgG antibodies reactive to neurons of the myenteric and submucosal plexuses of the jejunum and stomach. Ovarian cancer can lead to authentic luminal obstruction or to pseudoobstruction that results when circumferential invasion of a bowel segment arrests the forward progression of peristaltic contractions.

The onset of obstruction is usually insidious. Pain is the most common symptom and usually colicky in nature. Pain can also be due to abdominal distention, tumor masses, or hepatomegaly. Vomiting can be intermittent or continuous. Patients with complete obstruction usually have constipation. Physical examination may reveal abdominal distention with tympany, ascites, visible peristalsis, high-pitched bowel sounds, and tumor masses. Erect plain abdominal films may reveal multiple air-fluid levels and dilation of the small or large bowel. Acute cecal dilation to >12–14 cm is considered a surgical emergency because of the high likelihood of rupture. CT scan is useful in differentiating benign from malignant causes of obstruction in patients who have undergone surgery for malignancy. Malignant obstruction is suggested by a mass at the site of obstruction or prior surgery, adenopathy, or an abrupt transition zone and irregular bowel thickening at the obstruction site. Benign obstruction is more likely when CT shows mesenteric vascular changes, a large volume of ascites, or a smooth transition zone and smooth bowel thickening at the obstruction site. The prognosis for the patient with cancer who develops intestinal obstruction is poor; median survival is 3–4 months. About 25–30% of patients are found to have intestinal obstruction due to causes other than cancer. Adhesions from previous operations are a common benign cause. Ileus induced by vincristine or other drugs is another reversible cause.

### **Rx Treatment:** **INTESTINAL OBSTRUCTION**

The management of intestinal obstruction in patients with advanced malignancy depends on the extent of the underlying malignancy and the functional status of

the major organs. The initial management should include surgical evaluation. Operation is not always successful and may lead to further complications with a substantial mortality rate (10–20%). Laparoscopy can diagnose and treat malignant bowel obstruction in some cases. Self-expanding metal stents placed in the gastric outlet, duodenum, proximal jejunum, colon, or rectum may palliate obstructive symptoms at those sites without major surgery. Patients known to have advanced intraabdominal malignancy should receive a prolonged course of conservative management, including nasogastric decompression. Treatment with antiemetics, antispasmodics, and analgesics may allow patients to remain outside the hospital. Octreotide may relieve obstructive symptoms through its inhibitory effect on gastrointestinal secretion.

## URINARY OBSTRUCTION

Urinary obstruction may occur in patients with prostatic or gynecologic malignancies, particularly cervical carcinoma; metastatic disease from other primary sites such as carcinomas of the breast, stomach, lung, colon, and pancreas; or lymphomas. Radiation therapy to pelvic tumors may cause fibrosis and subsequent ureteral obstruction. Bladder outlet obstruction is usually due to prostate and cervical cancers and may lead to bilateral hydronephrosis and renal failure.

Flank pain is the most common symptom. Persistent urinary tract infection, persistent proteinuria, or hematuria in patients with cancer should raise suspicion of ureteral obstruction. Total anuria and/or anuria alternating with polyuria may occur. A slow, continuous rise in the serum creatinine level necessitates immediate evaluation. Renal ultrasound is the safest and cheapest way to identify hydronephrosis. The function of an obstructed kidney can be evaluated by a nuclear scan. CT scan can reveal the point of obstruction and identify a retroperitoneal mass or adenopathy.

### **Rx Treatment:** **URINARY OBSTRUCTION**

Obstruction associated with flank pain, sepsis, or fistula formation is an indication for immediate palliative urinary diversion. Internal ureteral stents can be placed under local anesthesia. Percutaneous nephrostomy offers an alternative approach for drainage. In the case of bladder outlet obstruction due to malignancy, a suprapubic cystostomy can be used for urinary drainage.

## MALIGNANT BILIARY OBSTRUCTION

This common clinical problem can be caused by a primary carcinoma arising in the pancreas, ampulla of Vater,

646 bile duct, or liver or by metastatic disease to the periductal lymph nodes or liver parenchyma. The most common metastatic tumors causing biliary obstruction are gastric, colon, breast, and lung cancers. Jaundice, light-colored stools, dark urine, pruritus, and weight loss due to malabsorption are usual symptoms. Pain and secondary infection are uncommon in malignant biliary obstruction. Ultrasound, CT scan, or percutaneous transhepatic or endoscopic retrograde cholangiography will identify the site and nature of the biliary obstruction.

### **Rx Treatment:** **MALIGNANT BILIARY OBSTRUCTION**

Palliative intervention is indicated only in patients with disabling pruritus resistant to medical treatment, severe malabsorption, or infection. Stenting under radiographic control, surgical bypass, or radiation therapy with or without chemotherapy may alleviate the obstruction. The choice of therapy should be based on the site of obstruction (proximal versus distal), the type of tumor (sensitive to radiotherapy, chemotherapy, or neither), and the general condition of the patient. In the absence of pruritus, biliary obstruction may be a largely asymptomatic cause of death.

## **SPINAL CORD COMPRESSION**

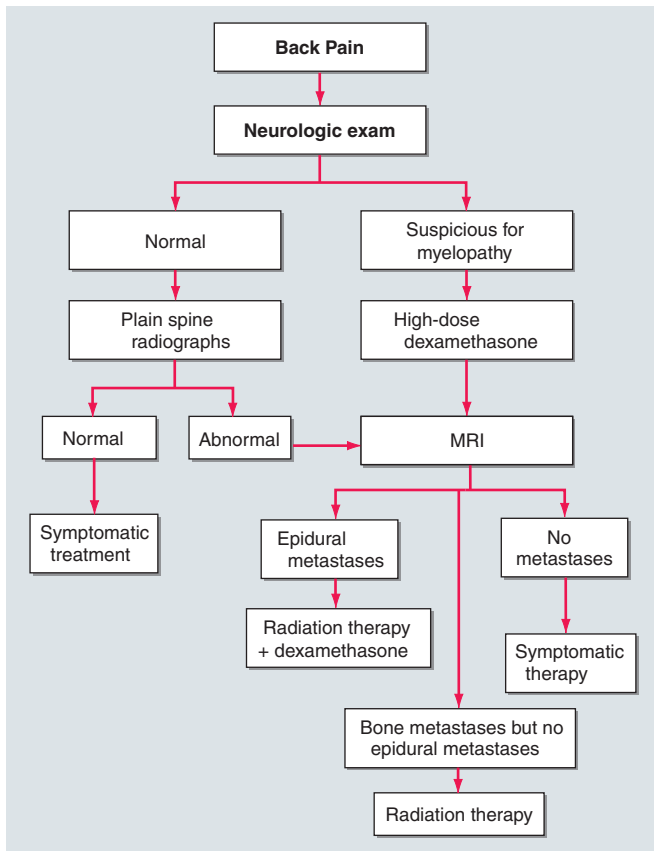
Malignant spinal cord compression (MSCC) is defined as compression of the spinal cord and/or cauda equina by an extradural tumor mass. The minimum radiologic evidence for cord compression is indentation of the theca at the level of clinical features. Spinal cord compression occurs in 5–10% of patients with cancer. Epidural tumor is the first manifestation of malignancy in ~10% of patients. The underlying cancer is usually identified during the initial evaluation; lung cancer is the most common cause of MSCC.

Metastatic tumor involves the vertebral column more often than any other part of the bony skeleton. Lung, breast, and prostate cancer are the most frequent offenders. Multiple myeloma also has a high incidence of spine involvement. Lymphomas, melanoma, renal cell cancer, and genitourinary cancers also cause cord compression. The thoracic spine is the most common site (70%), followed by the lumbosacral spine (20%) and the cervical spine (10%). Involvement of multiple sites is most frequent in patients with breast and prostate carcinoma. Cord injury develops when metastases to the vertebral body or pedicle enlarge and compress the underlying dura. Another cause of cord compression is direct extension of a paravertebral lesion through the intervertebral foramen. These cases usually involve a lymphoma, myeloma, or pediatric neoplasm. Parenchymal spinal cord metastasis due to hematogenous spread is rare.

Expanding extradural tumors induce injury through several mechanisms. Obstruction of the epidural venous plexus leads to edema. Local production of inflammatory cytokines enhances blood flow and edema formation. Compression compromises blood flow leading to ischemia. Production of vascular endothelial growth factor is associated with spinal cord hypoxia and has been implicated as a potential cause of damage after spinal cord injury.

The most common initial symptom in patients with spinal cord compression is localized back pain and tenderness due to involvement of vertebrae by tumor. Pain is usually present for days or months before other neurologic findings appear. It is exacerbated by movement and by coughing or sneezing. It can be differentiated from the pain of disc disease by the fact that it worsens when the patient is supine. Radicular pain is less common than localized back pain and usually develops later. Radicular pain in the cervical or lumbosacral areas may be unilateral or bilateral. Radicular pain from the thoracic roots is often bilateral and is described by patients as a feeling of tight, band-like constriction around the thorax and abdomen. Typical cervical radicular pain radiates down the arm; in the lumbar region, the radiation is down the legs. *Lhermitte's sign*, a tingling or electric sensation down the back and upper and lower limbs upon flexing or extending the neck, may be an early sign of cord compression. Loss of bowel or bladder control may be the presenting symptom but usually occurs late in the course.

On physical examination, pain induced by straight leg raising, neck flexion, or vertebral percussion may help to determine the level of cord compression. Patients develop numbness and paresthesias in the extremities or trunk. Loss of sensibility to pinprick is as common as loss of sensibility to vibration or position. The upper limit of the zone of sensory loss is often one or two vertebrae below the site of compression. Motor findings include weakness, spasticity, and abnormal muscle stretching. An extensor plantar reflex reflects significant compression. Deep tendon reflexes may be brisk. Motor and sensory loss usually precedes sphincter disturbance. Patients with autonomic dysfunction may present with decreased anal tonus, decreased perineal sensibility, and a distended bladder. The absence of the anal wink reflex or the bulbocavernosus reflex confirms cord involvement. In doubtful cases, evaluation of postvoiding urinary residual volume can be helpful. A residual volume of >150 mL suggests bladder dysfunction. Autonomic dysfunction is an unfavorable prognostic factor. Patients with progressive neurologic symptoms should have frequent neurologic examinations and rapid therapeutic intervention. Other illnesses that may mimic cord compression include osteoporotic vertebral collapse, disc disease, pyogenic abscess or vertebral tuberculosis, radiation myelopathy, neoplastic leptomeningitis, benign tumors, epidural hematoma, and spinal lipomatosis.



**FIGURE 51-2**  
Management of cancer patients with back pain.

*Cauda equina syndrome* is characterized by low back pain; diminished sensation over the buttocks; posterior-superior thighs; perineal area in a saddle distribution; rectal and bladder dysfunction; sexual impotence; absent bulbocavernosus, patellar, and Achilles’ reflexes; and variable amount of lower-extremity weakness. This reflects compression of nerve roots as they form the cauda equina after leaving the spinal cord.

Patients with cancer who develop back pain should be evaluated for spinal cord compression as quickly as possible (Fig. 51-2). Treatment is more often successful in patients who are ambulatory and still have sphincter control at the time treatment is initiated. Patients should have a neurologic examination and plain films of the spine. Those whose physical examination suggests cord compression should receive dexamethasone (24 mg intravenously every 6 h), starting immediately.

Erosion of the pedicles (the “winking owl” sign) is the earliest radiologic finding of vertebral tumor. Other radiographic changes include increased intrapedicular distance, vertebral destruction, lytic or sclerotic lesions, scalloped vertebral bodies, and vertebral body collapse. Vertebral collapse is not a reliable indicator of the presence of tumor; ~20% of cases of vertebral collapse, particularly those in older patients and postmenopausal women, are due not to cancer but to osteoporosis.

Also, a normal appearance on plain films of the spine does not exclude the diagnosis of cancer. The role of bone scans in the detection of cord compression is not clear; this method is sensitive but less specific than spinal radiography.

The full-length image of the cord provided by MRI is useful. Multiple epidural metastases are noted in 25% of patients with cord compression, and their presence influences treatment plans. On T1-weighted images, good contrast is noted between the cord, cerebrospinal fluid (CSF), and extradural lesions. Owing to its sensitivity in demonstrating the replacement of bone marrow by tumor, MRI can show which parts of a vertebra are involved by tumor. MRI also visualizes intraspinal extradural masses compressing the cord. T2-weighted images are most useful for the demonstration of intramedullary pathology. Gadolinium-enhanced MRI can help to delineate intramedullary disease. MRI is as good as or better than myelography plus postmyelogram CT scan in detecting metastatic epidural disease with cord compression. Myelography should be reserved for patients who have poor MR images or who cannot undergo MRI promptly. CT scan in conjunction with myelography enhances the detection of small areas of spinal destruction.

In patients with cord compression and an unknown primary tumor, a simple workup including chest radiography, mammography, measurement of prostate-specific antigen, and abdominal CT usually reveals the underlying malignancy.

**Rx Treatment:**  
**SPINAL CORD COMPRESSION**

The treatment of patients with spinal cord compression is aimed at relief of pain and restoration/preservation of neurologic function (Fig. 51-2).

Radiation therapy plus glucocorticoids is generally the initial treatment of choice for most patients with spinal cord compression. Up to 75% of patients treated when still ambulatory remain ambulatory, but only 10% of patients with paraplegia recover walking capacity. Indications for surgical intervention include unknown etiology, failure of radiation therapy, a radioresistant tumor type (e.g., melanoma or renal cell cancer), pathologic fracture dislocation, and rapidly evolving neurologic symptoms. Laminectomy is done for tissue diagnosis and for the removal of posteriorly localized epidural deposits in the absence of vertebral body disease. Because most cases of epidural spinal cord compression are due to anterior or anterolateral extradural disease, resection of the anterior vertebral body along with the tumor, followed by spinal stabilization, has achieved good results. A randomized trial showed that patients who underwent an operation followed by radiotherapy (within 14 days) retained the ability to walk significantly



longer than those treated with radiotherapy alone. Surgically treated patients also maintained continence and neurologic function significantly longer than patients in the radiation group. The length of survival was not significantly different in the two groups, although there was a trend toward longer survival in the surgery group. The study drew some criticism for the poorer than expected results in the patients who did not go to surgery. However, patients should be evaluated for surgery. Conventional radiotherapy has a role after surgery. Chemotherapy may have a role in patients with chemosensitive tumors who have had prior radiotherapy to the same region and who are not candidates for surgery. Most patients with prostate cancer who develop cord compression have already had hormonal therapy; however, for those who have not, androgen deprivation is combined with surgery and radiotherapy.

Patients with metastatic vertebral tumors may benefit from percutaneous vertebroplasty, the injection of acrylic cement into a collapsed vertebra to stabilize the fracture. Pain palliation is common, and local antitumor effects have been noted. Cement leakage may cause symptoms in ~10% of patients.

The histology of the tumor is an important determinant of both recovery and survival. Rapid onset and progression of signs and symptoms are poor prognostic features.

papilledema with visual disturbances and neck stiffness. As the mass enlarges, brain tissue may be displaced through the fixed cranial openings, producing various herniation syndromes.

CT scan and MRI are equally effective in the diagnosis of brain metastases. CT scan with contrast should be used as a screening procedure. The CT scan shows brain metastases as multiple enhancing lesions of various sizes with surrounding areas of low-density edema. If a single lesion or no metastases are visualized by contrast-enhanced CT, MRI of the brain should be performed. Gadolinium-enhanced MRI is more sensitive than CT at revealing meningeal involvement and small lesions, particularly in the brainstem or cerebellum.

Intracranial hypertension secondary to tretinoin therapy has been reported.

### **Rx Treatment:** **INCREASED INTRACRANIAL PRESSURE**

If signs and symptoms of brain herniation (particularly headache, drowsiness, and papilledema) are present, the patient should be intubated and hyperventilated to maintain  $P_{CO_2}$  between 25 and 30 mm Hg and should receive infusions of mannitol (1–1.5 g/kg) every 6 h. Dexamethasone is the best initial treatment for all symptomatic patients with brain metastases (see earlier). Patients with multiple lesions should receive whole-brain radiation therapy. Patients with a single brain metastasis and with controlled extracranial disease may be treated with surgical excision followed by whole-brain radiation therapy, especially if they are <60 years of age. Radioresistant tumors should be resected if possible. Stereotactic radiosurgery is an effective treatment for inaccessible or recurrent lesions. With a gamma knife or linear accelerator, multiple small, well-collimated beams of ionizing radiation destroy lesions seen on MRI. Some patients with increased intracranial pressure associated with hydrocephalus may benefit from shunt placement. If neurologic deterioration is not reversed with medical therapy, ventriculotomy to remove CSF or craniotomy to remove tumors or hematomas may be necessary.

### **NEOPLASTIC MENINGITIS**

Tumor involving the leptomeninges is a complication of both primary central nervous system (CNS) tumors and tumors that metastasize to the CNS. The incidence is estimated at 3–8% of patients with cancer. Melanoma, breast and lung cancer, lymphoma (including AIDS-associated), and acute leukemia are the most common causes. Synchronous intraparenchymal brain metastases are evident in 11–31% of patients with neoplastic meningitis.

Patients typically present with multifocal neurologic signs and symptoms, including headache, gait abnormality,

### **INCREASED INTRACRANIAL PRESSURE**

About 25% of patients with cancer die with intracranial metastases. The cancers that most often metastasize to the brain are lung and breast cancers and melanoma. Brain metastases often occur in the presence of systemic disease, and they frequently cause major symptoms, disability, and early death. The initial presentation of brain metastases from a previously unknown primary cancer is common. Lung cancer is most commonly the primary malignancy. Chest CT scans and brain MRI as the initial diagnostic studies can identify a biopsy site in most patients.

The signs and symptoms of a metastatic brain tumor are similar to those of other intracranial expanding lesions: headache, nausea, vomiting, behavioral changes, seizures, and focal, progressive neurologic changes. Occasionally the onset is abrupt, resembling a stroke, with the sudden appearance of headache, nausea, vomiting, and neurologic deficits. This picture is usually due to hemorrhage into the metastasis. Melanoma, germ cell tumors, and renal cell cancers have a particularly high incidence of intracranial bleeding. The tumor mass and surrounding edema may cause obstruction of the circulation of CSF, with resulting hydrocephalus. Patients with increased intracranial pressure may have

mental changes, nausea, vomiting, seizures, back or radicular pain, and limb weakness. Signs include cranial nerve palsies, extremity weakness, paresthesia, and decreased deep tendon reflexes.

Diagnosis is made by demonstrating malignant cells in the CSF; however, up to 40% of patients may have false-negative CSF cytology. An elevated CSF protein level is nearly always present (except in HTLV-1-associated adult T cell leukemia). Patients with neurologic signs and symptoms consistent with neoplastic meningitis who have a negative CSF cytology but an elevated CSF protein level should have the spinal tap repeated at least three times for cytologic examination before the diagnosis is rejected. MRI findings suggestive of neoplastic meningitis include leptomeningeal, subependymal, dural, or cranial nerve enhancement; superficial cerebral lesions; and communicating hydrocephalus. Spinal cord imaging by MRI is a necessary component of the evaluation of nonleukemia neoplastic meningitis because ~20% of patients have cord abnormalities, including intradural enhancing nodules that are diagnostic for leptomeningeal involvement. Cauda equina lesions are common, but lesions may be seen anywhere in the spinal canal. Radio-labeled CSF flow studies are abnormal in up to 70% of patients with neoplastic meningitis; ventricular outlet obstruction, abnormal flow in the spinal canal, or impaired flow over the cerebral convexities may affect distribution of intrathecal chemotherapy resulting in decreased efficacy or increased toxicity. Radiation therapy may correct CSF flow abnormalities before use of intrathecal chemotherapy. Neoplastic meningitis can also lead to intracranial hypertension and hydrocephalus. Placement of a ventriculoperitoneal shunt may effectively palliate symptoms in these patients.

The development of neoplastic meningitis usually occurs in the setting of uncontrolled cancer outside the CNS; thus prognosis is poor (median survival: 10–12 weeks). However, treatment of the neoplastic meningitis may successfully alleviate symptoms and control the CNS spread.

### **Rx Treatment:** **NEOPLASTIC MENINGITIS**

Intrathecal chemotherapy, usually methotrexate, cytarabine, or thiotepa, is delivered by lumbar puncture or by an intraventricular reservoir (Ommaya) three times a week until the CSF is free of malignant cells. Injections are given twice a week for a month and then weekly for a month. An extended-release preparation of cytarabine (DepoCyt) has a longer half-life and is more effective than other formulations. Among solid tumors, breast cancer responds best to therapy. Patients with neoplastic meningitis from either acute leukemia or lymphoma may be cured of their CNS disease if the systemic disease can be eliminated.

## SEIZURES

Seizures occurring in a patient with cancer can be caused by the tumor itself, by metabolic disturbances, by radiation injury, by cerebral infarctions, by chemotherapy-related encephalopathies, or by CNS infections. Metastatic disease to the CNS is the most common cause of seizures in patients with cancer. However, seizures occur more frequently in primary brain tumors than in metastatic brain lesions. Seizures are a presenting symptom of CNS metastasis in 6–29% of cases. Approximately 10% of patients with CNS metastasis eventually develop seizures. The presence of frontal lesions correlates with early seizures, and the presence of hemispheric symptoms increases the risk for late seizures. Both early and late seizures are uncommon in patients with posterior fossa lesions. Seizures are also common in patients with CNS metastases from melanoma. Very rarely, cytotoxic drugs such as etoposide, busulfan, and chlorambucil cause seizures.

### **Rx Treatment:** **SEIZURES**

Patients in whom seizures due to CNS metastases have been demonstrated should receive anticonvulsive treatment with diphenylhydantoin. Prophylactic anticonvulsant therapy is not recommended unless the patient is at a high risk for late seizures (melanoma primary, hemorrhagic metastases, treatment with radiosurgery). In those patients, serum diphenylhydantoin levels should be monitored closely and the dosage adjusted according to serum levels. Phenytoin induces the hepatic metabolism of dexamethasone, reducing its half-life; dexamethasone may decrease phenytoin levels. Most antiseizure medications induce CYP450, which alters the metabolism of antitumor agents, including irinotecan, taxanes, and etoposide as well as molecular targeted agents including imatinib, gefitinib, and tipifarnib.

## PULMONARY AND INTRACEREBRAL LEUKOCYTOSTASIS

Hyperleukocytosis and the leukostasis syndrome associated with it is a potentially fatal complication of acute leukemia (particularly myeloid leukemia) that can occur when the peripheral blast cell count is >100,000/mL. The frequency of hyperleukocytosis is 5–13% in AML and 10–30% in acute lymphoid leukemia; however, leukostasis is rare in lymphoid leukemia. At such high blast cell counts, blood viscosity is increased, blood flow is slowed by aggregates of tumor cells, and the primitive myeloid leukemic cells are capable of invading through endothelium and causing hemorrhage.

650 Brain and lung are most commonly affected. Patients with brain leukostasis may experience stupor, headache, dizziness, tinnitus, visual disturbances, ataxia, confusion, coma, or sudden death. Administration of 600 cGy of whole-brain irradiation can protect against this complication and can be followed by rapid institution of antileukemic therapy. Pulmonary leukostasis may present as respiratory distress, hypoxemia, and progress to respiratory failure. Chest radiographs may be normal but usually show interstitial or alveolar infiltrates. Arterial blood gas results should be interpreted cautiously. Rapid consumption of plasma oxygen by the markedly increased number of white blood cells can cause spuriously low arterial oxygen tension. Pulse oximetry is the most accurate way of assessing oxygenation in patients with hyperleukocytosis. Leukapheresis may be helpful in decreasing circulating blast counts. Treatment of the leukemia can result in pulmonary hemorrhage from lysis of blasts in the lung, called *leukemic cell lysis pneumopathy*. Intravascular volume depletion and unnecessary blood transfusions may increase blood viscosity and worsen the leukostasis syndrome. Leukostasis is not a feature of the high white cell counts associated with chronic lymphoid or chronic myeloid leukemia.

When acute promyelocytic leukemia is treated with differentiating agents like tretinoin and arsenic trioxide, cerebral or pulmonary leukostasis may occur as tumor cells differentiate into mature neutrophils. This complication can be largely avoided by using cytotoxic chemotherapy together with the differentiating agents.

## HEMOPTYSIS

Hemoptysis may be caused by nonmalignant conditions, but lung cancer accounts for a large proportion of cases. Up to 20% of patients with lung cancer have hemoptysis some time in their course. Endobronchial metastases from carcinoid tumors, breast cancer, colon cancer, kidney cancer, and melanoma may also cause hemoptysis. The volume of bleeding is often difficult to gauge. Massive hemoptysis is defined as >600 mL of blood produced in 24 h. However, any hemoptysis should be considered massive if it threatens life. When respiratory difficulty occurs, hemoptysis should be treated emergently. The first priorities are to maintain the airway, optimize oxygenation, and stabilize the hemodynamic status. Often patients can tell where the bleeding is occurring. They should be placed bleeding side down and given supplemental oxygen. If large-volume bleeding continues or the airway is compromised, the patient should be intubated and undergo emergency bronchoscopy. If the site of bleeding is detected, either the patient undergoes a definitive surgical procedure or the lesion is treated with a

neodymium:yttrium-aluminum-garnet (Nd:YAG) laser. The surgical option is preferred. Bronchial artery embolization may control brisk bleeding in 75–90% of patients, permitting the definitive surgical procedure to be done more safely. Embolization without definitive surgery is associated with rebleeding in 20–50% of patients. Recurrent hemoptysis usually responds to a second embolization procedure. A postembolization syndrome characterized by pleuritic pain, fever, dysphagia, and leukocytosis may occur; it lasts 5–7 days and resolves with symptomatic treatment. Bronchial or esophageal wall necrosis, myocardial infarction, and spinal cord infarction are rare complications.

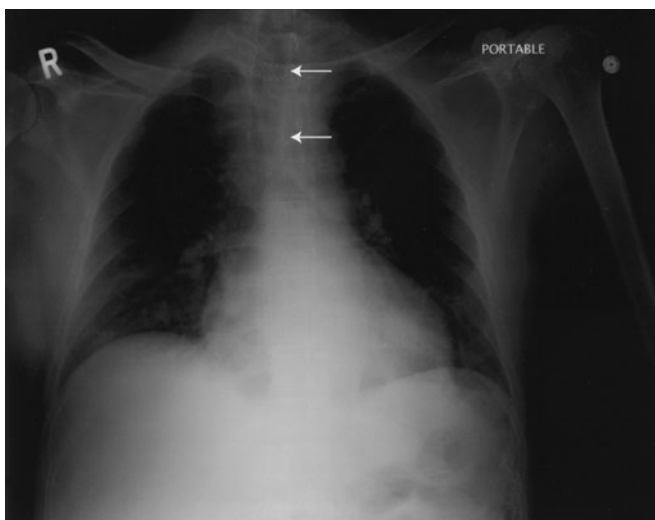
Pulmonary hemorrhage with or without hemoptysis in hematologic malignancies is often associated with fungal infections, particularly *Aspergillus* sp. After granulocytopenia resolves, the lung infiltrates in aspergillosis may cavitate and cause massive hemoptysis. Thrombocytopenia and coagulation defects should be corrected, if possible. Surgical evaluation is recommended in patients with aspergillosis-related cavitory lesions.

## AIRWAY OBSTRUCTION

*Airway obstruction* refers to a blockage at the level of the mainstem bronchi or above. It may result either from intraluminal tumor growth or from extrinsic compression of the airway. The most common cause of malignant upper airway obstruction is invasion from an adjacent primary tumor, most commonly lung cancer, followed by esophageal, thyroid, and mediastinal malignancies. Extrathoracic primary tumors such as renal, colon, or breast cancer can cause airway obstruction through endobronchial and/or mediastinal lymph node metastases. Patients may present with dyspnea, hemoptysis, stridor, wheezing, intractable cough, postobstructive pneumonia, or hoarseness. Chest radiographs usually demonstrate obstructing lesions. CT scans reveal the extent of tumor. Cool, humidified oxygen, glucocorticoids, and ventilation with a mixture of helium and oxygen (Heliox) may provide temporary relief. If the obstruction is proximal to the larynx, a tracheostomy may be lifesaving. For more distal obstructions, particularly intrinsic lesions incompletely obstructing the airway, bronchoscopy with laser treatment, photodynamic therapy, or stenting can produce immediate relief in most patients (Fig. 51-3). However, radiation therapy (either external-beam irradiation or brachytherapy) given together with glucocorticoids may also open the airway. Symptomatic extrinsic compression may be palliated by stenting. Patients with primary airway tumors such as squamous cell carcinoma, carcinoid tumor, adenocystic carcinoma, or non-small cell lung cancer should have surgery.



A



B

### FIGURE 51-3

**Airway obstruction.** **A.** CT scan of a 62-year-old man with tracheal obstruction caused by renal carcinoma showing paratracheal mass (A) with tracheal invasion/obstruction (arrow). **B.** Chest x-ray of same patient after stent (arrows) placement.

## METABOLIC EMERGENCIES

### HYPERCALCEMIA

Hypercalcemia is the most common paraneoplastic syndrome. Its pathogenesis and management are fully discussed in Chap. 49.

### SYNDROME OF INAPPROPRIATE SECRETION OF ANTIDIURETIC HORMONE (SIADH)

Hyponatremia is a common electrolyte abnormality in cancer patients, and SIADH is the most common cause of hyponatremia among patients with cancer. SIADH is discussed fully in Chap. 49.

### LACTIC ACIDOSIS

Lactic acidosis is a rare and potentially fatal metabolic complication of cancer. Lactic acidosis associated with

sepsis and circulatory failure is a common preterminal event in many malignancies. Lactic acidosis in the absence of hypoxemia may occur in patients with leukemia, lymphoma, or solid tumors. Extensive involvement of the liver by tumor is present in most cases. Alteration of liver function may be responsible for the lactate accumulation. HIV-infected patients have an increased risk of aggressive lymphoma; lactic acidosis that occurs in such patients may be related either to the rapid growth of the tumor or from toxicity of nucleoside reverse transcriptase inhibitors. Symptoms of lactic acidosis include tachypnea, tachycardia, change of mental status, and hepatomegaly. The serum level of lactic acid may reach 10–20 meq/L (90–180 mg/dL). Treatment is aimed at the underlying disease. The danger from lactic acidosis is from the acidosis, not the lactate. Sodium bicarbonate should be added if acidosis is very severe or if hydrogen ion production is very rapid and uncontrolled. The prognosis is poor.

### HYPOGLYCEMIA

Persistent hypoglycemia is occasionally associated with tumors other than pancreatic islet cell tumors. Usually these tumors are large; tumors of mesenchymal origin, hepatomas, or adrenocortical tumors may cause hypoglycemia. Mesenchymal tumors are usually located in the retroperitoneum or thorax. Obtundation, confusion, and behavioral aberrations occur in the postabsorptive period and may precede the diagnosis of the tumor. These tumors often secrete incompletely processed insulin-like growth factor II (IGF-II), a hormone capable of activating insulin receptors and causing hypoglycemia. Tumors secreting incompletely processed big IGF-II are characterized by an increased IGF-II to IGF-I ratio, suppressed insulin and C peptide level, and inappropriately low growth hormone and  $\beta$ -hydroxybutyrate concentrations. Rarely, hypoglycemia is due to insulin secretion by a non-islet cell carcinoma. The development of hepatic dysfunction from liver metastases and increased glucose consumption by the tumor can contribute to hypoglycemia. If the tumor cannot be resected, hypoglycemia symptoms may be relieved by the administration of glucose, glucocorticoids, or glucagon.

Hypoglycemia can be artifactual; hyperleukocytosis from leukemia, myeloproliferative diseases, leukemoid reactions, or colony-stimulating factor treatment can increase glucose consumption in the test tube after blood is drawn, leading to pseudohypoglycemia.

### ADRENAL INSUFFICIENCY

In patients with cancer, adrenal insufficiency may go unrecognized because the symptoms, such as nausea, vomiting, anorexia, and orthostatic hypotension, are non-specific and may be mistakenly attributed to progressive

652 cancer or to therapy. Primary adrenal insufficiency may develop owing to replacement of both glands by metastases (lung, breast, colon, or kidney cancer; lymphoma), to removal of both glands, or to hemorrhagic necrosis in association with sepsis or anticoagulation. Impaired adrenal steroid synthesis occurs in patients being treated for cancer with mitotane, ketoconazole, or aminoglutethimide or undergoing rapid reduction in glucocorticoid therapy. Rarely, metastatic replacement causes primary adrenal insufficiency as the first manifestation of an occult malignancy. Metastasis to the pituitary or hypothalamus is found at autopsy in up to 5% of patients with cancer, but associated secondary adrenal insufficiency is rare. Megestrol acetate, used to manage cancer and HIV-related cachexia, may suppress plasma levels of cortisol and adrenocorticotropic hormone (ACTH). Patients taking megestrol may develop adrenal insufficiency, and even those whose adrenal dysfunction is not symptomatic may have inadequate adrenal reserve if they become seriously ill. Cranial irradiation for childhood brain tumors may affect the hypothalamus–pituitary–adrenal axis, resulting in secondary adrenal insufficiency.

Acute adrenal insufficiency is potentially lethal. Treatment of suspected adrenal crisis is initiated after the sampling of serum cortisol and ACTH levels.

## TREATMENT-RELATED EMERGENCIES

### TUMOR LYSIS SYNDROME

Tumor lysis syndrome (TLS), characterized by hyperuricemia, hyperkalemia, hyperphosphatemia, and hypocalcemia, is caused by the destruction of a large number of rapidly proliferating neoplastic cells. Acidosis may also develop. Acute renal failure occurs frequently.

TLS is most often associated with the treatment of Burkitt's lymphoma, acute lymphoblastic leukemia, and other high-grade lymphomas, but it also may be seen with chronic leukemias and, rarely, with solid tumors. This syndrome has been seen in patients with chronic lymphocytic leukemia after treatment with nucleosides. TLS has been observed with administration of glucocorticoids, hormonal agents such as letrozole and tamoxifen, and monoclonal antibodies such as rituximab and gemtuzumab. TLS usually occurs during or shortly (1–5 days) after chemotherapy. Rarely, spontaneous necrosis of malignancies causes TLS.

Hyperuricemia may be present at the time of chemotherapy. Effective treatment kills malignant cells and leads to increased serum uric acid levels from the turnover of nucleic acids. Owing to the acidic local environment, uric acid can precipitate in the tubules, medulla, and collecting ducts of the kidney, leading to renal failure. Lactic acidosis and dehydration may contribute to the precipitation of uric acid in the renal tubules. The finding of uric acid crystals in the urine is

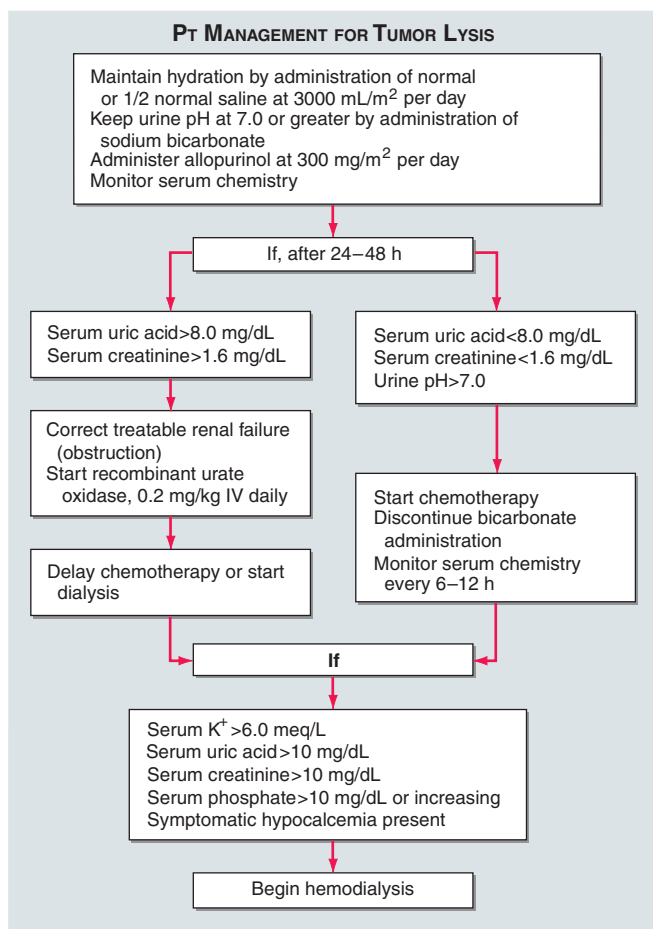
strong evidence for uric acid nephropathy. The ratio of urinary uric acid to urinary creatinine is  $>1$  in patients with acute hyperuricemic nephropathy and  $<1$  in patients with renal failure due to other causes.

Hyperphosphatemia, which can be caused by the release of intracellular phosphate pools by tumor lysis, produces a reciprocal depression in serum calcium, which causes severe neuromuscular irritability and tetany. Deposition of calcium phosphate in the kidney and hyperphosphatemia may cause renal failure. Potassium is the principal intracellular cation, and massive destruction of malignant cells may lead to hyperkalemia. Hyperkalemia in patients with renal failure may rapidly become life-threatening by causing ventricular arrhythmias and sudden death.

The likelihood that TLS will occur in patients with Burkitt's lymphoma is related to the tumor burden and renal function. Hyperuricemia and high serum levels of lactate dehydrogenase (LDH  $> 1500$  U/L), both of which correlate with total tumor burden, also correlate with the risk of TLS. In patients at risk for TLS, pretreatment evaluations should include a complete blood count, serum chemistry evaluation, and urine analysis. High leukocyte and platelet counts may artificially elevate potassium levels ("pseudohyperkalemia") due to lysis of these cells after the blood is drawn. In these cases, plasma potassium instead of serum potassium should be followed. In pseudohyperkalemia, no electrocardiographic abnormalities are present. In patients with abnormal baseline renal function, the kidneys and retroperitoneal area should be evaluated by sonography and/or CT to rule out obstructive uropathy. Urine output should be watched closely.

#### **Rx Treatment:** **TUMOR LYSIS SYNDROME**

Recognition of risk and prevention are the most important steps in the management of this syndrome (Fig. 51-4). The standard preventive approach consists of allopurinol, urinary alkalization, and aggressive hydration. Intravenous allopurinol may be given in patients who cannot tolerate oral therapy. In some cases, uric acid levels cannot be lowered sufficiently with the standard preventive approach. Rasburicase can be effective in these instances. Urate oxidase is missing from primates and catalyzes the conversion of poorly soluble uric acid to readily soluble allantoin. Rasburicase acts rapidly, decreasing uric acid levels within hours; however, it may cause hypersensitivity reactions such as bronchospasm, hypoxemia, and hypotension. Rasburicase is contraindicated in patients with glucose-6-phosphate dehydrogenase deficiency who are unable to break down hydrogen peroxide, an end product of the urate oxidase reaction. Despite aggressive prophylaxis, TLS and/or oliguric or



**FIGURE 51-4**  
Management of patients at high risk for the tumor lysis syndrome.

anuric renal failure may occur. Care should be taken to prevent worsening of symptomatic hypocalcemia by induction of alkalosis during bicarbonate infusion. Administration of sodium bicarbonate may also lead to urinary precipitation of calcium phosphate, which is less soluble at alkaline pH. Dialysis is often necessary and should be considered early in the course. Hemodialysis is preferred. Hemofiltration offers a gradual, continuous method of removing cellular byproducts and fluid. The prognosis is excellent, and renal function recovers after the uric acid level is lowered to  $\leq 10$  mg/dL.

## HUMAN ANTIBODY INFUSION REACTIONS

The initial infusion of human or humanized antibodies (e.g., rituximab, gemtuzumab, trastuzumab) is associated with fever, chills, nausea, asthenia, and headache in up to half of treated patients. Bronchospasm and hypotension occur in 1% of patients. The pathogenesis is thought to be activation of immune effector processes (cells and complement). In the presence of high levels of circulating lymphoid tumor cells, thrombocytopenia, a rapid fall in circulating tumor cells, and mild electrolyte evidence

of TLS may also occur. In addition, increased liver enzymes, D-dimer, LDH, and prolongation of the prothrombin time may occur. This syndrome is related to release of inflammatory cytokines, such as tumor necrosis factor  $\alpha$  and interleukin 6. Diphenhydramine and acetaminophen can often prevent or suppress the symptoms. If they occur, the infusion is stopped and restarted at half the initial infusion rate after the symptoms have abated.

## HEMOLYTIC-UREMIC SYNDROME

Hemolytic-uremic syndrome (HUS) and, less commonly, thrombotic thrombocytopenic purpura (TTP) occurring after treatment with antineoplastic drugs have been described. Mitomycin is by far the most common agent causing this peculiar syndrome. Other chemotherapeutic agents, including cisplatin, bleomycin, and gemcitabine, have also been reported to be associated with this syndrome. It occurs most often in patients with gastric, colorectal, pancreatic, and breast carcinoma. In one series, 35% of patients were without evident cancer at the time this syndrome appeared. Secondary HUS/TTP has also been reported as a rare but sometimes fatal complication of bone marrow transplantation.

HUS usually has its onset 4–8 weeks after the last dose of chemotherapy, but it is not rare to detect it several months later. HUS is characterized by microangiopathic hemolytic anemia, thrombocytopenia, and renal failure. Dyspnea, weakness, fatigue, oliguria, and purpura are also common initial symptoms and findings. Systemic hypertension and pulmonary edema frequently occur. Severe hypertension, pulmonary edema, and rapid worsening of hemolysis and renal function may occur after a blood or blood product transfusion. Cardiac findings include atrial arrhythmias, pericardial friction rub, and pericardial effusion. Raynaud's phenomenon is part of the syndrome in patients treated with bleomycin.

Laboratory findings include severe to moderate anemia associated with red blood cell fragmentation and numerous schistocytes on peripheral smear. Reticulocytosis, decreased plasma haptoglobin, and an LDH level document hemolysis. The serum bilirubin level is usually normal or slightly elevated. The Coombs' test is negative. The white cell count is usually normal, and thrombocytopenia ( $<100,000/\mu\text{L}$ ) is almost always present. Most patients have a normal coagulation profile, although some have mild elevations in thrombin time and in level of fibrin degradation products. The serum creatinine level is elevated at presentation and shows a pattern of subacute worsening within weeks of the initial azotemia. The urinalysis reveals hematuria, proteinuria, and granular or hyaline casts; circulating immune complexes may be present.

The basic pathologic lesion appears to be deposition of fibrin in the walls of capillaries and arterioles, and

654 these deposits are similar to those seen in HUS due to other causes. These microvascular abnormalities involve mainly the kidneys and rarely occur in other organs. The pathogenesis of chemotherapy-related HUS is unknown. Other forms of HUS/TTP are related to a decrease in processing of von Willebrand's factor by a protease called ADAMTS13.

The case fatality rate is high; most patients die within a few months. Plasmapheresis and plasma exchange may normalize the hematologic abnormalities, but renal failure is not reversed in most patients. Immunoperfusion over a staphylococcal protein A column is the most successful treatment. About half of the patients treated with immunoperfusion respond with resolution of thrombocytopenia, improvement in anemia, and stabilization of renal failure. Treatment is well tolerated. It is not clear how the treatment works.

## NEUTROPENIA AND INFECTION

These remain the most common serious complications of cancer therapy. They are covered in detail in Chap. 28.

## PULMONARY INFILTRATES

Patients with cancer may present with dyspnea associated with diffuse interstitial infiltrates on chest radiographs. Such infiltrates may be due to progression of the underlying malignancy, treatment-related toxicities, infection, and/or unrelated diseases. The cause may be multifactorial; however, most commonly they occur as a consequence of treatment. Infiltration of the lung by malignancy has been described in patients with leukemia, lymphoma, and breast and other solid cancers. Pulmonary lymphatics may be involved diffusely by neoplasm (pulmonary lymphangitic carcinomatosis), resulting in a diffuse increase in interstitial markings on chest radiographs. The patient is often mildly dyspneic at the onset, but pulmonary failure develops over a period of weeks. In some patients, dyspnea precedes changes on the chest radiographs and is accompanied by a nonproductive cough. This syndrome is characteristic of solid tumors. In patients with leukemia, diffuse microscopic neoplastic peribronchial and peribronchiolar infiltration is frequent but may be asymptomatic. However, some patients present with diffuse interstitial infiltrates, an alveolar capillary block syndrome, and respiratory distress. In these situations, glucocorticoids can provide symptomatic relief, but specific chemotherapy should always be started promptly.

Several cytotoxic agents, such as bleomycin, methotrexate, busulfan, and the nitrosoureas, may cause pulmonary damage. The most frequent presentations are interstitial pneumonitis, alveolitis, and pulmonary fibrosis. Some cytotoxic agents, including methotrexate and procarbazine, may cause an acute hypersensitivity reaction. Cytosine arabinoside has been associated with

noncardiogenic pulmonary edema. Administration of multiple cytotoxic drugs, as well as radiotherapy and preexisting lung disease, may potentiate the pulmonary toxicity. Supplemental oxygen may potentiate the effects of drugs and radiation injury. Patients should always be managed with the lowest  $F_{IO_2}$  that is sufficient to maintain hemoglobin saturation.

The onset of symptoms may be insidious, with symptoms including dyspnea, nonproductive cough, and tachycardia. Patients may have bibasilar crepitant rales, end-inspiratory crackles, fever, and cyanosis. The chest radiograph generally shows an interstitial and sometimes an intraalveolar pattern that is strongest at the lung bases and may be symmetric. A small effusion may occur. Hypoxemia with decreased carbon monoxide diffusing capacity is always present. Glucocorticoids may be helpful in patients in whom pulmonary toxicity is related to radiation therapy or to chemotherapy. Treatment is otherwise supportive.

Molecular-targeted agents imatinib, erlotinib, and gefitinib are potent inhibitors of tyrosine kinases. These drugs may cause interstitial lung disease. In the case of gefitinib, preexisting fibrosis, poor performance status, and prior thoracic irradiation are independent risk factors; this complication has a high fatality rate. In Japan, incidence of interstitial lung disease associated with gefitinib was ~4.5%.

Radiation pneumonitis and/or fibrosis is a relatively frequent side effect of thoracic radiation therapy. It may be acute or chronic. Radiation-induced lung toxicity is a function of the irradiated lung volume, dose per fraction, and radiation dose. The larger the irradiated lung field, the higher the risk for radiation pneumonitis. Radiation pneumonitis usually develops from 2 to 6 months after completion of radiotherapy. The clinical syndrome, which varies in severity, consists of dyspnea, cough with scanty sputum, low-grade fever, and an initial hazy infiltrate on chest radiographs. The infiltrate and tissue damage usually are confined to the radiation field. The patients subsequently may develop a patchy alveolar infiltrate and air bronchograms, which may progress to acute respiratory failure that is sometimes fatal. A lung biopsy may be necessary to make the diagnosis. Asymptomatic infiltrates found incidentally after radiation therapy need not be treated. However, prednisone should be administered to patients with fever or other symptoms. The dosage should be tapered slowly after the resolution of radiation pneumonitis because abrupt withdrawal of glucocorticoids may cause an exacerbation of pneumonia. Delayed radiation fibrosis may occur years after radiation therapy and is signaled by dyspnea on exertion. Often it is mild, but it can progress to chronic respiratory failure. Therapy is supportive.

Classical radiation pneumonitis that leads to pulmonary fibrosis is due to radiation-induced production of local cytokines such as platelet-derived growth factor  $\beta$ ,

tumor necrosis factor, and transforming growth factor  $\beta$  in the radiation field. An immunologically mediated sporadic radiation pneumonitis occurs in ~10% of patients; bilateral alveolitis mediated by T cells results in infiltrates outside the radiation field. This form of radiation pneumonitis usually resolves without sequelae.

Pneumonia is a common problem in patients undergoing treatment for cancer. Bacterial pneumonia typically causes a localized infiltrate on chest radiographs. Therapy is tailored to the causative organism. When diffuse interstitial infiltrates appear in a febrile patient, the differential diagnosis is extensive and includes pneumonia due to infection with *Pneumocystis carinii*; viral infections including cytomegalovirus, adenovirus, herpes simplex virus, herpes zoster, respiratory syncytial virus, or intracellular pathogens such as *Mycoplasma* and *Legionella*; effects of drugs or radiation; tumor progression; nonspecific pneumonitis; and fungal disease. Detection of opportunistic pathogens in pulmonary infections is still a challenge. Diagnostic tools include chest radiographs, CT scans, bronchoscopy with bronchoalveolar lavage, brush cytology, transbronchial biopsy, fine-needle aspiration, and open lung biopsy. In addition to the culture, evaluation of bronchoalveolar lavage fluid for *P. carinii* by polymerase chain reaction (PCR) and aspergillus antigen improve the diagnostic yield. Patients with cancer who are neutropenic and have fever and local infiltrates on chest radiograph should be treated initially with broad-spectrum antibiotics such as ceftazidime or imipenem. A new or persistent focal infiltrate not responding to broad-spectrum antibiotics argues for initiation of empiric antifungal therapy. When diffuse bilateral infiltrates develop in patients with febrile neutropenia, broad-spectrum antibiotics plus trimethoprim-sulfamethoxazole, with or without erythromycin, should be initiated. Addition of an antiviral agent is necessary in some settings, such as patients undergoing allogeneic hematopoietic stem cell transplantation. The empiric administration of trimethoprim-sulfamethoxazole plus erythromycin to patients without neutropenia and these antibiotics plus ceftazidime to patients with neutropenia covers nearly every treatable diagnosis (except tumor progression) and gives as good overall survival as a strategy based on early invasive intervention with bronchoalveolar lavage or open lung biopsy. If the patient does not improve in 4 days, open lung biopsy is the procedure of choice. Bronchoscopy with bronchoalveolar lavage may be used in patients who are poor candidates for surgery.

In patients with pulmonary infiltrates who are afebrile, heart failure and multiple pulmonary emboli are in the differential diagnosis.

## NEUTROPENIC ENTEROCOLITIS

*Neutropenic enterocolitis* (typhlitis) is the inflammation and necrosis of the cecum and surrounding tissues that may complicate the treatment of acute leukemia. This



A



B

**FIGURE 51-5** Abdominal CT scans of a 72-year-old woman with neutropenic enterocolitis secondary to chemotherapy. **A.** Air in inferior mesenteric vein (arrow) and bowel wall with pneumatosis intestinalis. **B.** CT scans of upper abdomen demonstrating air in portal vein (arrows).

complication has also been seen in patients with other forms of cancer treated with taxanes and in patients receiving high-dose chemotherapy (Fig. 51-5). The patient develops right lower quadrant abdominal pain, often with rebound tenderness and a tense, distended abdomen, in a setting of fever and neutropenia. Watery diarrhea (often containing sloughed mucosa) and bacteremia are common, and bleeding may occur. Plain abdominal films are generally of little value in the diagnosis; CT scan may show marked bowel wall thickening, particularly in the cecum, with bowel wall edema. Patients with bowel wall thickness >10 mm on ultrasonogram have higher mortality rates. However, bowel wall thickening is significantly more prominent in patients with *Clostridium difficile* colitis. Pneumatosis intestinalis is a more specific finding, seen only in those



656 with neutropenic enterocolitis and ischemia. The combined involvement of the small and large bowel suggests a diagnosis of neutropenic enterocolitis. Rapid institution of broad-spectrum antibiotics and nasogastric suction may reverse the process. Surgical intervention should be considered if no improvement is seen by 24 h after the start of antibiotic treatment. If the localized abdominal findings become diffuse, the prognosis is poor.

*C. difficile* colitis is increasing in incidence. Newer strains of *C. difficile* produce ~20 times more of toxins A and B compared to previously studied strains. *C. difficile* risk is also increased with chemotherapy. Antibiotic coverage for *C. difficile* should be added if pseudomembranous colitis cannot be excluded.

## HEMORRHAGIC CYSTITIS

Hemorrhagic cystitis can develop in patients receiving cyclophosphamide or ifosfamide. Both drugs are metabolized to acrolein, which is a strong chemical irritant excreted in the urine. Prolonged contact or high concentrations may lead to bladder irritation and hemorrhage. Symptoms include gross hematuria, frequency, dysuria, burning, urgency, incontinence, and nocturia. The best management is prevention. Maintaining a high rate of urine flow minimizes exposure. In addition, 2-mercaptoethanesulfonate (mesna) detoxifies the metabolites and can be coadministered with the instigating drugs. Mesna usually is given three times on the day of ifosfamide administration in doses that are each 20% of the total ifosfamide dose. If hemorrhagic cystitis develops, the maintenance of a high urine flow may be sufficient supportive care. If conservative management is not effective, irrigation of the bladder with a 0.37–0.74% formalin solution for 10 min stops the bleeding in most cases. *N*-acetylcysteine may also be an effective irrigant. Prostaglandins (carboprost) can inhibit the process. In extreme cases, ligation of the hypogastric arteries, urinary diversion, or cystectomy may be necessary.

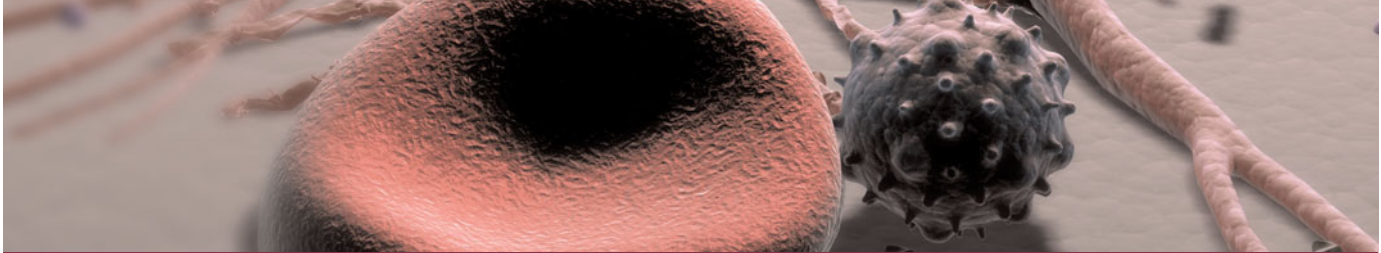
Hemorrhagic cystitis also occurs in patients who undergo bone marrow transplantation (BMT). In the BMT setting, early-onset hemorrhagic cystitis is related to drugs in the treatment regimen (e.g., cyclophosphamide) and late-onset hemorrhagic cystitis is usually due to the polyoma virus BKV or adenovirus type 11. BKV load in urine alone or in combination with acute graft-versus-host disease correlate with development of hemorrhagic cystitis. Viral causes are usually detected by PCR-based diagnostic tests. Treatment of viral hemorrhagic cystitis is largely supportive, with reduction in doses of immunosuppressive agents, if possible. No antiviral therapy is approved, although cidofovir is being tested.

## HYPERSENSITIVITY REACTIONS TO ANTINEOPLASTIC DRUGS

Many antineoplastic drugs may cause hypersensitivity reaction (HSR). These reactions are unpredictable and potentially life-threatening. Most reactions occur during or within hours of parenteral drug administration. Taxanes; platinum compounds; asparaginase; etoposide; and biologic agents including rituximab, bevacizumab, trastuzumab, gemtuzumab, cetuximab, and alemtuzumab are more commonly associated with acute HSR than are other agents. Acute hypersensitivity reactions to some drugs, such as taxanes, occur during the first or second dose administered. HSR from platinum compounds occurs after prolonged exposure. Skin testing may identify patients with high risk for HSR after carboplatin exposure. Premedication with histamine H<sub>1</sub> and H<sub>2</sub> receptor antagonists and glucocorticoids reduce the incidence of hypersensitivity reaction to taxanes, particularly paclitaxel. Despite premedication, HSR may still occur. In these cases, retreatment may be attempted with care, but use of alternative agents may be required.

## FURTHER READINGS

- ALBANELL J, BASELGA J: Systemic therapy emergencies. *Semin Oncol* 27:347, 2000
- CHAICHANA KL et al: Vertebral compression fractures in patients presenting with metastatic epidural spinal cord compression. *Neurosurgery* 65:267, 2009
- COIFFIER B, RIOUFFOL C: Management of tumor lysis syndrome in adults. *Expert Rev Anticancer Ther* 7:233, 2007
- DARMON M, AZOULAY E: Critical care management of cancer patients: Cause for optimism and need for objectivity. *Curr Opin Oncol* 21:318, 2009
- DAVIS MP et al: Modern management of cancer-related intestinal obstruction. *Curr Oncol Rep* 2:343, 2000
- GLEISSNER B et al: Neoplastic meningitis. *Lancet Neurol* 5:443, 2006
- GORNIK HL et al: Abnormal cytology predicts poor prognosis in cancer patients with pericardial effusion. *J Clin Oncol* 23:5211, 2005
- GORSCHLUTER M et al: Neutropenic enterocolitis in adults: Systematic analysis of evidence quality. *Eur J Hematol* 75:1, 2005
- KACPROWICZ RE, LLOYD JD: Electrolyte complications of malignancy. *Emerg Med Clin North Am* 27:257, 2009
- LOBLAW DA et al: Systematic review of the diagnosis and management of malignant extradural spinal cord compression: The Cancer Care Ontario Practice Guidelines Initiative's neuro-oncology disease site group. *J Clin Oncol* 23:2028, 2005
- RICE TW et al: The superior vena cava syndrome: Clinical characteristics and evolving etiology. *Medicine* 85:37, 2006
- RIPAMONTI C et al: Respiratory problems in advanced cancer. *Support Care Cancer* 10:204, 2002
- WAN JF, BEZJAK A: Superior vena cava syndrome. *Emerg Med Clin North Am* 27:243, 2009
- ZANOTTI KM et al: Prevention and management of antineoplastic-induced hypersensitivity reactions; *Drug Saf* 24:767, 2001



## CHAPTER 52

# LATE CONSEQUENCES OF CANCER AND ITS TREATMENT

Michael C. Perry ■ Dan L. Longo

■ Consequences By Organ System . . . . .	.659	■ Consequences By Cancer Type . . . . .	.661
Cardiovascular Dysfunction . . . . .	.659	Pediatric Cancers . . . . .	.661
Pulmonary Dysfunction . . . . .	.659	Hodgkin's Disease . . . . .	.661
Liver Dysfunction . . . . .	.659	Non-Hodgkin's Lymphomas . . . . .	.661
Renal/Bladder Dysfunction . . . . .	.659	Acute Leukemia . . . . .	.661
Endocrine Dysfunction . . . . .	.659	Head and Neck Cancer . . . . .	.661
Nervous System Dysfunction . . . . .	.659	Stem Cell Transplantation . . . . .	.661
Eyes . . . . .	.660	Breast Cancer . . . . .	.661
Sexual and Reproductive Dysfunction . . . . .	.660	Testicular Cancer . . . . .	.662
Musculoskeletal Dysfunction . . . . .	.660	Colon Cancer . . . . .	.662
Raynaud's Phenomenon . . . . .	.660	Prostate Cancer . . . . .	.662
Oral Complications . . . . .	.660	■ Outlook . . . . .	.662
■ Second Malignancies . . . . .	.660	■ Further Readings . . . . .	.662

More than 9 million Americans alive today have had cancer. Virtually all of these survivors will bear some mark of their diagnosis and its therapy, and many will experience long-term complications, including medical problems, psychosocial disturbances, sexual dysfunction, and inability to find employment or insurance.

Problems may be related to the cancer itself (e.g., patients with primary cancers of the head and neck are at increased risk for subsequent lung cancer) or to the normal aging process (surviving one cancer does not necessarily alter the risk of other common tumors that increase in frequency with age). However, many of the problems affecting cured patients are related to the treatments. Individuals carefully followed for periods up to 30 years have taught us the spectrum of problems that can be encountered. Because of heterogeneity in treatment details and incompleteness of follow-up, some treatment-related problems went undetected for many years. However, studies of long-term survivors of childhood cancers, acute leukemia, Hodgkin's disease, lymphomas, testicular cancer, and localized solid tumors have identified the features of cancer treatment that are

associated with later morbidity and mortality. We have been somewhat slow to act in changing those aspects of primary treatment that contribute to these late problems. This reticence is due to the uncertainty associated with changing a treatment that is known to work before having a replacement that works as well.

Survivorship issues have been addressed by the Institute of Medicine and the National Research Council, who have published a monograph on this subject: *From Cancer Patient to Cancer Survivor: Lost in Transition*. Their "Survivorship Care Plan," if uniformly carried out, would inform clinicians who assume the care of cancer survivors of their previous treatments; signs and symptoms of late effects; and, where established, guidelines for intervention. An "End-of-Treatment Consultation Note" would include the date, physician's name, date of tissue diagnosis, diagnosis, stage, pathologic findings, initial treatment plan, and treatment received. In addition, unusual or unexpected toxicities would be noted and the expected short- and long-term effects of treatment detailed. Suggestions for monitoring for late toxicity should be given as well, including recommendations for

658 surveillance for recurrence and second malignancies, the physician(s) responsible for monitoring, and any identified psychosocial issues or concerns.

The first task in a newly diagnosed patient is always to eradicate the diagnosed malignancy. Late problems occurring in cured patients reflect the success of such treatment. These problems never develop in those who do not survive the cancer. Morbidity and mortality from iatrogenic disease should be avoided, if possible; however, the risk of late complications should not lead to the failure to apply potentially curative treatment. The challenge is to preserve or augment the cure rate while decreasing the risk of serious treatment-related illness.

The mechanisms of damage vary. Surgical procedures can create abnormal physiology (such as blind loops leading to malabsorption) or interfere with normal organ function (splenectomy leading to impaired immune

response). Radiation therapy can damage organ function directly (salivary gland toxicity leading to dry mouth and dental caries), act as a carcinogen (second solid tumors in radiation ports), or promote accelerated aging-associated changes (atherosclerosis). Cancer chemotherapy can produce damage to the bone marrow and immune system and induce a spectrum of organ dysfunctions. Therapy may produce subclinical damage that may only become recognized in the presence of a second inciting factor (such as the increased incidence of melanoma in patients with dysplastic nevus syndrome treated for Hodgkin's disease with radiation therapy). Finally, cancer and its treatment are associated with psychosocial problems that can impair the survivor's ability to adapt to life after cancer.

Late effects by treatment modality are shown in **Table 52-1**. Drug toxicities and radiation therapy toxicities are discussed in Chap. 27.

**TABLE 52-1**

LATE EFFECTS OF CANCER THERAPY		
SURGICAL PROCEDURE		EFFECT
Amputation		Functional loss
Lymph node dissection		Risk of lymphedema
Ostomy		Psychosocial impact
Splenectomy		Risk of sepsis
Adhesions		Risk of obstruction
Bowel anastomoses		Malabsorption syndromes
RADIATION THERAPY		EFFECT
Organ		
Bone		Premature termination of growth, osteonecrosis
Soft tissues		Atrophy, fibrosis
Brain		Neuropsychiatric deficits, cognitive dysfunction
Thyroid		Hypothyroidism, Graves' disease, cancer
Salivary glands		Dry mouth, caries, dysgeusia
Eyes		Cataracts
Heart		Pericarditis, myocarditis, coronary artery disease
Lung		Pulmonary fibrosis
Kidney		Decreased function, hypertension
Liver		Decreased function
Intestine		Malabsorption, stricture
Gonads		Infertility, premature menopause
Any		Secondary neoplasia
CHEMOTHERAPY		EFFECT
Organ	Drug	
Bone	Glucocorticoids	Osteoporosis, avascular necrosis
Brain	Methotrexate, ara-C, others	Neuropsychiatric deficits, cognitive decline?
Peripheral nerves	Vincristine, platinum, taxanes	Neuropathy, hearing loss
Eyes	Glucocorticoids	Cataracts
Heart	Anthracyclines, trastuzumab	Cardiomyopathy
Lung	Bleomycin	Pulmonary fibrosis
	Methotrexate	Pulmonary hypersensitivity
Kidney	Platinum, others	Decreased function, hypomagnesemia
Liver	Various	Altered function
Gonads	Alkylating agents, others	Infertility, premature menopause
Bone marrow	Various	Aplasia, myelodysplasia, secondary leukemia

## CONSEQUENCES BY ORGAN SYSTEM

### CARDIOVASCULAR DYSFUNCTION

Most anthracyclines damage the heart muscle. A dose-dependent dropout of myocardial cells is seen on endomyocardial biopsy, and eventually ventricular failure ensues. About 5% of patients who receive  $>550$  mg/m<sup>2</sup> of doxorubicin develop congestive heart failure (CHF). Coexisting cardiac disease, hypertension, advanced age, and concomitant therapy with thoracic radiation therapy may hasten the onset of CHF. Anthracycline-induced CHF is not readily reversible and mortality is as high as 50%; thus prevention is the best approach. Mitoxantrone is a related drug that has less cardiac toxicity. Administration of doxorubicin by continuous intravenous infusion or encapsulated in liposomes appears to decrease the risk of heart damage. Dexrazoxane, an intracellular iron chelator, may protect the heart against anthracycline toxicity by preventing iron-dependent free-radical generation. Concern about antagonism of antitumor effects has restricted its use.

Mediastinal radiation therapy that includes the heart can induce acute pericarditis, chronic constrictive pericarditis, myocardial fibrosis, valvular abnormalities, or accelerated premature coronary atherosclerosis. The incidence of acute pericarditis is 5–13%; patients may be asymptomatic or have dyspnea on exertion, fever, and chest pain. The onset is insidious, with a peak ~9 months after treatment. Pericardial effusion may be present. Chronic constrictive pericarditis can develop 5–10 years after treatment and usually presents with dyspnea on exertion. Myocardial fibrosis may present as unexplained CHF with diagnostic evaluation showing restrictive cardiomyopathy. Patients may have aortic insufficiency from valvular thickening or mitral regurgitation from papillary muscle dysfunction. Patients who receive mantle field radiation therapy have a threefold increased risk of *fatal* myocardial infarction. Similarly, radiation of the carotids is associated with premature atherosclerosis of the carotids and can produce central nervous system (CNS) embolic disease. At very high doses, such as those used before hematopoietic stem cell transplantation, cyclophosphamide can produce a hemorrhagic myocarditis. Trastuzumab (Herceptin) has been associated with heart failure, particularly in patients also receiving anthracyclines. Compromised ejection fraction is noted in ~10% of patients; it is usually reversible with the cessation of therapy.

### PULMONARY DYSFUNCTION

Pulmonary fibrosis from bleomycin is dose-related, with potential exacerbation by age, preexisting lung disease, thoracic radiation, high concentrations of inhaled oxygen, and the concomitant use of other chemotherapeutic

agents. Several other chemotherapy agents and radiation therapy can cause pulmonary fibrosis, and several can cause pulmonary venoocclusive disease, especially following high-dose therapy such as that involved in hematopoietic stem cell transplantation.

### LIVER DYSFUNCTION

Clinically significant long-term damage to the liver from standard-dose chemotherapy is relatively infrequent and mostly confined to patients who have received chronic methotrexate for maintenance therapy of acute lymphoblastic leukemia. Radiation doses to the liver  $>1500$  cGy can produce liver dysfunction. Although rarely seen with standard-dose chemotherapy, hepatic venoocclusive disease is more common with high-dose therapy, such as that given to prepare patients for autologous or allogeneic stem cell transplantation. Endothelial damage is probably the inciting event.

### RENAL/BLADDER DYSFUNCTION

Reduced renal function may be produced by cisplatin; it is usually asymptomatic but may render the patient more susceptible to other renal insults. Cyclophosphamide cystitis may eventually lead to the development of bladder cancer. Ifosfamide produces cystitis and a proximal tubular defect, a Fanconi-like syndrome that is usually, but not always, reversible.

### ENDOCRINE DYSFUNCTION

Long-term survivors of childhood cancer who received cranial irradiation are shorter, more likely to be obese, and have reductions in strength, exercise tolerance, and bone mineral density. The obesity may be related to alterations in leptin biology. Growth hormone deficiency is the most common hormone deficiency.

Thyroid disease is common in patients who have received radiation therapy to the neck, such as patients with Hodgkin's disease, with an incidence of up to 62% at 26 years posttherapy. Hypothyroidism is the most common abnormality, followed by Graves' disease, thyroiditis, and cancer. Such patients should have frequent measurement of thyroid-stimulating hormone (TSH) levels to detect hypothyroidism early and suppress the TSH drive, which may contribute to thyroid cancer.

### NERVOUS SYSTEM DYSFUNCTION

Although many patients experience peripheral neuropathy during chemotherapy, only a few have chronic problems, perhaps because they have other coexisting diseases such as diabetes mellitus. High doses of cisplatin can produce severe sensorimotor neuropathy. Vincristine may produce permanent numbness and tingling in the fingers and toes.

Neurocognitive sequelae from intrathecal chemotherapy, with or without radiation therapy, are recognized complications of the successful therapy of childhood acute lymphoblastic leukemia. Cognitive decline has been attributed to CNS radiation in the treatment of a variety of tumor types. In addition, cognitive decline (“chemo brain”) can follow the use of adjuvant chemotherapy in women being treated for breast cancer. Because the agents are given at modest doses and are not thought to cross the blood-brain barrier, the mechanism of the cognitive decline is not defined. The phenomenon has not yet been documented in adequately designed studies that take into account the normal age-associated decline in cognition.

Many patients suffer intrusive thoughts about cancer recurrence for many years after successful treatment. Adjustment to normal expectations can be difficult. Cancer survivors may often have more problems holding a job, staying in a stable relationship, and coping with the usual stresses of daily life. Suicidal symptoms are reported by a significant minority of adult survivors of childhood cancer and represent treatable conditions requiring follow-up care.

A dose-related hearing loss can occur with the use of cisplatin, usually with doses  $>400$  mg/m<sup>2</sup>. This is irreversible, and patients should be screened with audiometric examinations periodically during such therapy.

## EYES

Cataracts may be caused by chronic glucocorticoid use, radiation therapy to the head, and, rarely, by tamoxifen.

## SEXUAL AND REPRODUCTIVE DYSFUNCTION

Reversible azoospermia can be caused by many chemotherapy agents. The gonads may also be permanently damaged by radiation therapy or by chemotherapeutic agents, particularly the alkylating agents. The extent of the damage depends on the patient’s age and the total dose administered. As a woman nears menopause, smaller amounts of chemotherapy will produce ovarian failure. In men, chemotherapy may produce infertility, but hormone production is not usually affected. Women, however, commonly lose both fertility and hormone production. The premature induction of menopause in a young woman can have serious medical and psychological consequences. Hormone replacement therapy is controversial. Paroxetine and related drugs may be useful in controlling hot flashes.

## MUSCULOSKELETAL DYSFUNCTION

Late consequences of radiation therapy on the musculoskeletal system occur mostly in children and are

related to the radiation dose, volume of tissue irradiated, and the age of the child at the time of therapy. Damage to the microvasculature of the epiphyseal growth zone may result in leg-length discrepancy, scoliosis, and short stature.

## RAYNAUD’S PHENOMENON

Up to 40% of patients with testicular cancer treated with bleomycin may experience Raynaud’s phenomenon varying in severity from mild and transient to severe. The mechanism is unknown.

## ORAL COMPLICATIONS

Radiation therapy can damage the salivary glands, producing dry mouth. Without saliva, dental caries develop, and many patients have poor dentition. In rare patients, taste can be adversely affected and appetite can be suppressed.

## SECOND MALIGNANCIES

Second malignancies are a major cause of death for those cured of cancer. Second malignancies can be grouped into three categories: those associated with the primary cancer, those caused by radiation therapy, and those caused by chemotherapy.

Primary cancers increase the risk of secondary cancers in a number of settings. Patients with head and neck cancers are at increased risk of developing a lung or esophageal cancer, and vice versa, probably because of shared risk factors, especially tobacco abuse. Patients with breast cancer are at increased risk of a second breast cancer in the contralateral breast. Patients with Hodgkin’s disease are at increased risk of non-Hodgkin’s lymphoma. Patients with genetic syndromes, such as multiple endocrine neoplasia type 1 or Lynch syndrome, are at increased risk of second cancers of specific types. In none of these examples does it appear that treatment of the primary cancer is the cause of the secondary cancer, but a role for treatment is difficult to exclude. These predispositions should result in heightened surveillance in persons at risk. The risk of second cancer is often sufficiently high that cured cancer patients would make excellent candidates to assess chemoprevention strategies.

Patients treated with radiation therapy have an increasing and apparently lifelong risk of developing second solid tumors, usually in or adjacent to the radiation field. The risk is modest in the first decade after treatment but reaches 1–2% per year in the second decade, such that populations followed for  $\geq 25$  years have a  $\geq 25\%$  chance of developing a second treatment-related tumor. Some organs differ in their susceptibility to radiation carcinogenesis with age; women receiving chest radiation therapy after age 30 have a small increased

risk of breast cancer, but those <30 have a 19-fold increased risk. A 25-year-old woman who received mantle-field radiation therapy for Hodgkin's disease has an absolute risk of 29% of developing breast cancer by age 55 years. The chances of curing the second malignancies hinge on early diagnosis. Patients who were treated with radiation therapy should be carefully examined on an annual basis and evaluated for any abnormalities in organs and tissues that were in the radiation field. Symptoms in a patient cured of cancer should not be dismissed because they may be an early sign of second cancers. Studies are needed to assess preventive measures in patients at high risk of second cancers.

Chemotherapy produces two clinical syndromes that can be fatal: myelodysplasia and acute myeloid leukemia. Two types of acute leukemia have been described. The first occurs in patients treated with alkylating agents, especially over a protracted period. The malignant cells frequently carry genetic deletions in chromosomes 5 or 7. The lifetime risk is ~2%; the risk is increased by the addition of radiation therapy and is about three times higher in people treated >40 years of age. It peaks in incidence 4–6 years after treatment; the risk returns to baseline if no disease has developed within 10 years of treatment. The second type of acute leukemia occurs after exposure to topoisomerase II inhibitors such as doxorubicin or etoposide. It is morphologically indistinguishable from the first but contains a characteristic chromosome translocation involving 10q23. The incidence is <1%, and it usually occurs 1.5–3 years after treatment. Both forms of acute leukemia are highly refractory to treatment, and no preventive strategy has been developed.

Hormonal manipulations can also cause second tumors. Tamoxifen induces endometrial cancer in ~1–2% of women taking it for ≥5 years. Usually these tumors are found at an early stage; mortality from endometrial cancer is very low compared to the benefit from tamoxifen use as adjuvant therapy in women with breast cancer.

## CONSEQUENCES BY CANCER TYPE

### PEDIATRIC CANCERS

Quality of life is often excellent, although the majority have at least one late effect. About a third of long-term survivors have moderate to severe problems. Cognitive function may be impaired. Late effects are worse for those with poor socioeconomic status. Functional impairments in the cardiovascular system due to radiation therapy and anthracyclines, and in the lungs due to radiation therapy, are rare. Scoliosis and/or delayed growth due to radiation of the skeleton are more common. Many survivors have psychosocial and sexual problems. Second malignant neoplasms are a significant cause of death.

### HODGKIN'S DISEASE

The patient cured of Hodgkin's disease remains subject to long-term medical problems such as thyroid dysfunction, premature coronary artery disease, gonadal dysfunction, postsplenectomy sepsis, and second malignancies. The second malignancies encountered include myelodysplasia and acute myeloid leukemia, non-Hodgkin's lymphomas, breast cancer, lung cancer, and melanoma. The major risk factor for hematologic malignancies is treatment with alkylating agents plus radiation therapy, whereas solid tumors are more likely to be seen with the use of radiation therapy. Patients cured of Hodgkin's disease seem to experience greater fatigue, have more psychosocial and sexual problems, and report a poorer quality of life than patients cured of acute leukemia.

### NON-HODGKIN'S LYMPHOMAS

The patient cured of a non-Hodgkin's lymphoma may be at increased risk of myelodysplasia and acute leukemia if high doses or prolonged courses of alkylating agents were used. Chronic exposure to cyclophosphamide increases the risk of bladder cancer. Patients cured of lymphoma report a very good quality of life.

### ACUTE LEUKEMIA

The late effects of antileukemic therapy include second malignancies (hematologic and solid tumors), neuropsychiatric difficulties, subnormal growth, thyroid abnormalities, and infertility.

### HEAD AND NECK CANCER

Patients frequently have poor dentition, dry mouth, trismus, difficulty in eating, and poor nutrition. Those with nasopharyngeal cancer report the poorest long-term quality of life, possibly related to the volume of disease that is radiated.

### STEM CELL TRANSPLANTATION

Cured patients are at risk of second cancers, especially if radiation therapy was part of the treatment. They are also subject to gonadal damage and infertility. Graft-versus-host disease is the leading factor contributing to the morbidity and mortality from allogeneic bone marrow transplantation, with an immune-mediated attack against the skin, liver, and gut epithelium. About half of patients report psychosocial problems.

### BREAST CANCER

Patients treated with adjuvant chemotherapy and/or hormonal therapy for breast cancer are at risk for endometrial cancer from the use of tamoxifen. The alternatives to

662 tamoxifen, the aromatase inhibitors, do not protect against osteoporosis and may increase the risk of this complication. Those patients who have received chemotherapy may be at risk from doxorubicin- or radiation-induced cardiomyopathy and acute leukemia. Trastuzumab (Herceptin) may contribute to heart failure. The development of premature ovarian failure from chemotherapy may cause hormone-deficient symptoms (hot flashes, decreased vaginal secretions, dyspareunia) and places women at risk for osteoporosis and cardiovascular death. Patients commonly report intrusive thoughts of cancer and psychological distress.

## TESTICULAR CANCER

Depending on the modalities used for therapy, patients cured of testicular cancer can anticipate Raynaud's phenomenon, renal and/or pulmonary damage from chemotherapy, and retrograde ejaculation from retroperitoneal lymph node dissection. Sexual dysfunction is reported by 15% of patients cured of testicular cancer.

## COLON CANCER

To date the major threat to patients with colorectal cancer treated with chemotherapy and/or radiation therapy remains the risk of a second colorectal cancer. Quality of life is reported as high in long-term survivors.

## PROSTATE CANCER

Radical surgical treatment is often accompanied by impotence, and ~10–15% develop some urine incontinence. Use of radiation therapy increases the risk of second cancers and may produce chronic prostatitis or cystitis.

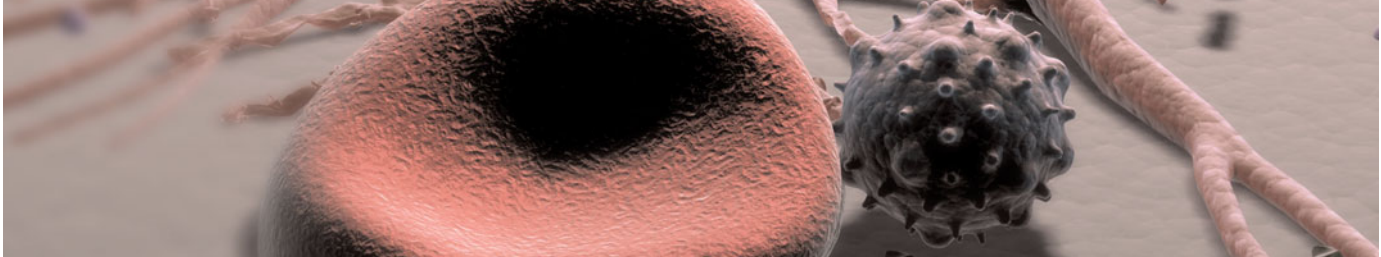
## OUTLOOK

The challenge for the future is to integrate new chemotherapy and biologic agents and newer techniques of delivering radiation therapy in a fashion that increases cure rates and lowers the late effects of treatment. Additional populations at risk for late effects include those with

cancers where therapy is becoming more effective, such as ovarian cancer, and cancers where chemotherapy and radiation therapy are used together in an organ-sparing approach, such as bladder, anal, and laryngeal cancers. Patients who have been cured of a cancer represent an important resource for cancer prevention studies. The Childhood Cancer Survivor Study reported that survivors have a high rate of illness due to chronic health conditions. This incidence increases with time and does not appear to plateau, indicating that monitoring of survivors is a critical component of their overall health care.

## FURTHER READINGS

- ABOU-MOURAD YR et al: Long-term outcome after Allo-SCT: Close follow-up on a large cohort treated with myeloablative regimens. *Bone Marrow Transplant* 2009; July 13 (Epub ahead of print)
- AHLES T et al: Neuropsychiatric impact of standard-dose chemotherapy in long-term survivors of breast cancer and lymphoma. *J Clin Oncol* 20:485, 2002
- BHATIA S, CONSTINE LS: Late morbidity after successful treatment of children with cancer. *Cancer J* 15:174, 2009
- BOOKMAN MA et al: Late complications of curative treatment in Hodgkin's disease. *JAMA* 260:680, 1988
- BROWN LM et al: Risk of second non-hematologic malignancies among 376,825 breast cancer survivors. *Breast Cancer Res Treat* Feb 3, 2007 PMID:17277968
- DE BRUIN ML et al: Increased risk of stroke and transient ischemic attack in 5-year survivors of Hodgkin lymphoma. *J Natl Cancer Inst* 101:928, 2009
- HEWITT M et al (eds): *From Cancer Patient to Cancer Survivor: Lost in Transition*. (Committee on Cancer Survivorship: Improving Care and Quality of Life.) Washington, DC, National Academies Press, 2006
- MACKIE E et al: Adult psychosocial outcomes in long-term survivors of acute lymphoblastic leukemia and Wilms' tumor: A controlled study. *Lancet* 355:1310, 2000
- MEADOWS AT et al: Second neoplasms in survivors of childhood cancer: Findings from the Childhood Cancer Survivor Study cohort. *J Clin Oncol* 27:2356, 2009
- TRAVIS LB et al: Cumulative absolute breast cancer risk for young women treated for Hodgkin lymphoma. *J Natl Cancer Inst* 97:1428, 2005
- SAWKA AM et al: Second primary malignancy risk after radioactive iodine treatment for thyroid cancer: A systematic review and meta-analysis. *Thyroid* 19:451, 2009



## APPENDIX

# LABORATORY VALUES OF CLINICAL IMPORTANCE

Alexander Kratz ■ Michael A. Pesce ■ Daniel J. Fink<sup>†</sup>

■ Introductory Comments . . . . .	663
■ Reference Values for Laboratory Tests . . . . .	664
■ Reference Values for Specific Analytes . . . . .	676
■ Special Function Tests . . . . .	679
■ Miscellaneous . . . . .	683
■ Further Readings . . . . .	683

### INTRODUCTORY COMMENTS

The following are tables of reference values for laboratory tests, special analytes, and special function tests. A variety of factors can influence reference values. Such variables include the population studied, the duration and means of specimen transport, laboratory methods and instrumentation, and even the type of container used for the collection of the specimen. The reference or “normal” ranges given in this appendix may therefore not be appropriate for all laboratories, and these values should only be used as general guidelines. Whenever possible, reference values provided by the laboratory performing the testing should be used in the interpretation of laboratory data. Values supplied in this appendix reflect typical reference ranges in adults.

Pediatric reference ranges may vary significantly from adult values.

In preparing the appendix, the authors have taken into account the fact that the system of international units (SI, *système international d’unités*) is used in most countries and in some medical journals. However, clinical laboratories may continue to report values in “conventional” units. Therefore, both systems are provided in the appendix. The dual system is also used in the text except for (1) those instances in which the numbers remain the same but only the terminology is changed (mmol/L for meq/L or IU/L for mIU/mL), when only the SI units are given; and (2) most pressure measurements (e.g., blood and cerebrospinal fluid pressures), when the conventional units (mm Hg, mm H<sub>2</sub>O) are used. In all other instances in the text, the SI unit is followed by the traditional unit in parentheses.

<sup>†</sup>Deceased.



TABLE A-1

## HEMATOLOGY AND COAGULATION

ANALYTE	SPECIMEN <sup>a</sup>	SI UNITS	CONVENTIONAL UNITS
Activated clotting time	WB	70–180 s	70–180 seconds
Activated protein C resistance (Factor V Leiden)	P	Not applicable	Ratio >2.1
Alpha <sub>2</sub> antiplasmin	P	0.87–1.55	87–155%
Antiphospholipid antibody panel			
PTT-LA (Lupus anticoagulant screen)	P	Negative	Negative
Platelet neutralization procedure	P	Negative	Negative
Dilute viper venom screen	P	Negative	Negative
Anticardiolipin antibody	S		
IgG		0–15 arbitrary units	0–15 GPL
IgM		0–15 arbitrary units	0–15 MPL
Antithrombin III	P		
Antigenic		220–390 mg/L	22–39 mg/dL
Functional		0.7–1.30 U/L	70–130%
Anti-Xa assay (heparin assay)	P		
Unfractionated heparin		0.3–0.7 kIU/L	0.3–0.7 IU/mL
Low-molecular-weight heparin		0.5–1.0 kIU/L	0.5–1.0 IU/mL
Danaparoid (Orgaran)		0.5–0.8 kIU/L	0.5–0.8 IU/mL
Autohemolysis test	WB	0.004–0.045	0.4%–4.50%
Autohemolysis test with glucose	WB	0.003–0.007	0.3%–0.7%
Bleeding time (adult)		<7.1 min	<7.1 min
Bone marrow: see <b>Table A-8</b>			
Clot retraction	WB	0.50–1.00/2 h	50–100%/2 h
Cryofibrinogen	P	Negative	Negative
D-Dimer	P	0.22–0.74 µg/mL	0.22–0.74 µg/mL
Differential blood count	WB		
Neutrophils		0.40–0.70	40–70%
Bands		0.0–0.05	0–5%
Lymphocytes		0.20–0.50	20–50%
Monocytes		0.04–0.08	4–8%
Eosinophils		0.0–0.6	0–6%
Basophils		0.0–0.02	0–2%
Eosinophil count	WB	150–300/µL	150–300/mm <sup>3</sup>
Erythrocyte count	WB		
Adult males		4.30–5.60 × 10 <sup>12</sup> /L	4.30–5.60 × 10 <sup>6</sup> /mm <sup>3</sup>
Adult females		4.00–5.20 × 10 <sup>12</sup> /L	4.00–5.20 × 10 <sup>6</sup> /mm <sup>3</sup>
Erythrocyte life span	WB		
Normal survival		120 days	120 days
Chromium labeled, half life (t <sub>1/2</sub> )		25–35 days	25–35 days
Erythrocyte sedimentation rate	WB		
Females		0–20 mm/h	0–20 mm/h
Males		0–15 mm/h	0–15 mm/h
Euglobulin lysis time	P	7200–14400 s	120–240 min
Factor II, prothrombin	P	0.50–1.50	50–150%
Factor V	P	0.50–1.50	50–150%
Factor VII	P	0.50–1.50	50–150%
Factor VIII	P	0.50–1.50	50–150%
Factor IX	P	0.50–1.50	50–150%
Factor X	P	0.50–1.50	50–150%
Factor XI	P	0.50–1.50	50–150%
Factor XII	P	0.50–1.50	50–150%
Factor XIII screen	P	Not applicable	Present
Factor inhibitor assay	P	<0.5 Bethesda Units	<0.5 Bethesda Units

(Continued)

TABLE A-1 (CONTINUED)

HEMATOLOGY AND COAGULATION			
ANALYTE	SPECIMEN <sup>a</sup>	SI UNITS	CONVENTIONAL UNITS
Fibrin(ogen) degradation products	P	0–1 mg/L	0–1 µg/mL
Fibrinogen	P	2.33–4.96 g/L	233–496 mg/dL
Glucose-6-phosphate dehydrogenase (erythrocyte)	WB	<2400 s	<40 min
Ham's test (acid serum)	WB	Negative	Negative
Hematocrit	WB		
Adult males		0.388–0.464	38.8–46.4
Adult females		0.354–0.444	35.4–44.4
Hemoglobin			
Plasma	P	6–50 mg/L	0.6–5.0 mg/dL
Whole blood	WB		
Adult males		133–162 g/L	13.3–16.2 g/dL
Adult females		120–158 g/L	12.0–15.8 g/dL
Hemoglobin electrophoresis	WB		
Hemoglobin A		0.95–0.98	95–98%
Hemoglobin A <sub>2</sub>		0.015–0.031	1.5–3.1%
Hemoglobin F		0–0.02	0–2.0%
Hemoglobins other than A, A <sub>2</sub> , or F		Absent	Absent
Heparin-induced thrombocytopenia antibody	P	Negative	Negative
Joint fluid crystal	JF	Not applicable	No crystals seen
Joint fluid mucin	JF	Not applicable	Only type I mucin present
Leukocytes			
Alkaline phosphatase (LAP)	WB	0.2–1.6 µkat/L	13–100 µ/L
Count (WBC)	WB	3.54–9.06 × 10 <sup>9</sup> /L	3.54–9.06 × 10 <sup>3</sup> /mm <sup>3</sup>
Mean corpuscular hemoglobin (MCH)	WB	26.7–31.9 pg/cell	26.7–31.9 pg/cell
Mean corpuscular hemoglobin concentration (MCHC)	WB	323–359 g/L	32.3–35.9 g/dL
Mean corpuscular hemoglobin of reticulocytes (CH)	WB	24–36 pg	24–36 pg
Mean corpuscular volume (MCV)	WB	79–93.3 fL	79–93.3 µm <sup>3</sup>
Mean platelet volume (MPV)	WB	9.00–12.95 fL	9.00–12.95 µm <sup>3</sup>
Osmotic fragility of erythrocytes	WB		
Direct		0.0035–0.0045	0.35–0.45%
Index		0.0030–0.0065	0.30–0.65%
Partial thromboplastin time, activated	P	26.3–39.4 s	26.3–39.4 s
Plasminogen	P		
Antigen		84–140 mg/L	8.4–14.0 mg/dL
Functional		0.70–1.30	70–130%
Plasminogen activator inhibitor 1	P	4–43 µg/L	4–43 ng/mL
Platelet aggregation	PRP	Not applicable	>65% aggregation in response to adenosine diphosphate, epinephrine, collagen, ristocetin, and arachidonic acid
Platelet count	WB	165–415 × 10 <sup>9</sup> /L	165–415 × 10 <sup>3</sup> /mm <sup>3</sup>
Platelet, mean volume	WB	6.4–11 fL	6.4–11.0 µm <sup>3</sup>
Prekallikrein assay	P	0.50–1.5	50–150%
Prekallikrein screen	P		No deficiency detected
Protein C	P		
Total antigen		0.70–1.40	70–140%
Functional		0.70–1.30	70–130%
Protein S	P		
Total antigen		0.70–1.40	70–140%
Functional		0.65–1.40	65–140%
Free antigen		0.70–1.40	70–140%
Prothrombin gene mutation G20210A	WB	Not applicable	Not present
Prothrombin time	P	12.7–15.4 s	12.7–15.4 s
Protoporphyrin, free erythrocyte	WB	0.28–0.64 µmol/L of red blood cells	16–36 µg/dL of red blood cells
Red cell distribution width	WB	<0.145	<14.5%
Reptilase time	P	16–23.6 s	16–23.6 s

(Continued)

## HEMATOLOGY AND COAGULATION

ANALYTE	SPECIMEN <sup>a</sup>	SI UNITS	CONVENTIONAL UNITS
Reticulocyte count	WB		
Adult males		0.008–0.023 red cells	0.8–2.3% red cells
Adult females		0.008–0.020 red cells	0.8–2.0% red cells
Reticulocyte hemoglobin content	WB	>26 pg/cell	>26 pg/cell
Ristocetin cofactor (functional von Willebrand's factor)	P		
Blood group O		0.75 mean of normal	75% mean of normal
Blood group A		1.05 mean of normal	105% mean of normal
Blood group B		1.15 mean of normal	115% mean of normal
Blood group AB		1.25 mean of normal	125% mean of normal
Sickle cell test	WB	Negative	Negative
Sucrose hemolysis	WB	<0.1	<10% hemolysis
Thrombin time	P	15.3–18.5 s	15.3–18.5 s
Total eosinophils	WB	150–300 × 10 <sup>6</sup> /L	150–300/mm <sup>3</sup>
Transferrin receptor	S, P	9.6–29.6 nmol/L	9.6–29.6 nmol/L
Viscosity			
Plasma	P	1.7–2.1	1.7–2.1
Serum	S	1.4–1.8	1.4–1.8
Von Willebrand's factor (vWF) antigen (factor VIII:R antigen)	P		
Blood group O		0.75 mean of normal	75% mean of normal
Blood group A		1.05 mean of normal	105% mean of normal
Blood group B		1.15 mean of normal	115% mean of normal
Blood group AB		1.25 mean of normal	125% mean of normal
Von Willebrand's factor multimers	P	Normal distribution	Normal distribution
White blood cells: see "Leukocytes"			

<sup>a</sup>P, plasma; JF, joint fluid; PRP, platelet-rich plasma; S, serum; WB, whole blood.

TABLE A-2

## CLINICAL CHEMISTRY AND IMMUNOLOGY

ANALYTE	SPECIMEN <sup>a</sup>	SI UNITS	CONVENTIONAL UNITS
Acetoacetate	P	20–99 μmol/L	0.2–1.0 mg/dL
Adrenocorticotropin (ACTH)	P	1.3–16.7 pmol/L	6.0–76.0 pg/mL
Alanine aminotransferase (AST, SGPT)	S	0.12–0.70 μkat/L	7–41 U/L
Albumin	S		
Female		41–53 g/L	4.1–5.3 g/dL
Male		40–50 g/L	4.0–5.0 g/dL
Aldolase	S	26–138 nkat/L	1.5–8.1 U/L
Aldosterone (adult)			
Supine, normal sodium diet	S, P	55–250 pmol/L	2–9 ng/dL
Upright, normal sodium diet	S, P		2–5-fold increase over supine value
Supine, low-sodium diet	S, P		2–5-fold increase over normal sodium diet level
	U	6.38–58.25 nmol/d	2.3–21.0 μg/24 h
Alpha fetoprotein (adult)	S	0–8.5 μg/L	0–8.5 ng/mL
Alpha <sub>1</sub> antitrypsin	S	1.0–2.0 g/L	100–200 mg/dL
Ammonia, as NH <sub>3</sub>	P	11–35 μmol/L	19–60 μg/dL
Amylase (method dependent)	S	0.34–1.6 μkat/L	20–96 U/L
Androstenedione (adult)	S	1.75–8.73 nmol/L	50–250 ng/dL
Angiotensin-converting enzyme (ACE)	S	0.15–1.1 μkat/L	9–67 U/L
Anion gap	S	7–16 mmol/L	7–16 mmol/L
Apo B/Apo A-1 ratio		0.35–0.98	0.35–0.98
Apolipoprotein A-1	S	1.19–2.40 g/L	119–240 mg/dL
Apolipoprotein B	S	0.52–1.63 g/L	52–163 mg/dL

(Continued)

TABLE A-2 (CONTINUED)

CLINICAL CHEMISTRY AND IMMUNOLOGY			
ANALYTE	SPECIMEN <sup>a</sup>	SI UNITS	CONVENTIONAL UNITS
Arterial blood gases			
[HCO <sub>3</sub> <sup>-</sup> ]		22–30 mmol/L	22–30 meq/L
PCO <sub>2</sub>		4.3–6.0 kPa	32–45 mmHg
pH		7.35–7.45	7.35–7.45
PO <sub>2</sub>		9.6–13.8 kPa	72–104 mmHg
Aspartate aminotransferase (AST, SGOT)	S	0.20–0.65 $\mu$ kat/L	12–38 U/L
Autoantibodies			
Anti-adrenal antibody	S	Not applicable	Negative at 1:10 dilution
Anti-double-strand (native) DNA	S	Not applicable	Negative at 1:10 dilution
Anti-glomerular basement membrane antibodies	S		
Qualitative		Negative	Negative
Quantitative		<5 kU/L	<5 U/mL
Anti-granulocyte antibody	S	Not applicable	Negative
Anti-Jo-1 antibody	S	Not applicable	Negative
Anti-La antibody	S	Not applicable	Negative
Anti-mitochondrial antibody	S	Not applicable	Negative
Antineutrophil cytoplasmic autoantibodies, cytoplasmic (C-ANCA)	S		
Qualitative		Negative	Negative
Quantitative (antibodies to proteinase 3)		<2.8 kU/L	<2.8 U/mL
Antineutrophil cytoplasmic autoantibodies, perinuclear (P-ANCA)	S		
Qualitative		Negative	Negative
Quantitative (antibodies to myeloperoxidase)		<1.4 kU/L	<1.4 U/mL
Antinuclear antibody	S	Not applicable	Negative at 1:40
Anti-parietal cell antibody	S	Not applicable	Negative at 1:20
Anti-Ro antibody	S	Not applicable	Negative
Anti-platelet antibody	S	Not applicable	Negative
Anti-RNP antibody	S	Not applicable	Negative
Anti-Scl 70 antibody	S	Not applicable	Negative
Anti-Smith antibody	S	Not applicable	Negative
Anti-smooth-muscle antibody	S	Not applicable	Negative at 1:20
Anti-thyroglobulin	S	Not applicable	Negative
Anti-thyroid antibody	S	<0.3 kIU/L	<0.3 IU/mL
B type natriuretic peptide (BNP)	P	Age and gender specific: <167 ng/L	Age and gender specific: <167 pg/mL
Bence Jones protein, serum	S	Not applicable	None detected
Bence Jones protein, urine, qualitative	U	Not applicable	None detected in 50 $\times$ concentrated urine
Bence Jones Protein, urine, quantitative	U		
Kappa		<25 mg/L	<2.5 mg/dL
Lambda		<50 mg/L	<5.0 mg/dL
$\beta_2$ -Microglobulin	S	<2.7 mg/L	<0.27 mg/dL
	U	<120 $\mu$ g/d	<120 $\mu$ g/day
Bilirubin	S		
Total		5.1–22 $\mu$ mol/L	0.3–1.3 mg/dL
Direct		1.7–6.8 $\mu$ mol/L	0.1–0.4 mg/dL
Indirect		3.4–15.2 $\mu$ mol/L	0.2–0.9 mg/dL
C peptide (adult)	S, P	0.17–0.66 nmol/L	0.5–2.0 ng/mL
C1-esterase-inhibitor protein	S		
Antigenic		124–250 mg/L	12.4–24.5 mg/dL
Functional		Present	Present
CA 125	S	0–35 kU/L	0–35 U/mL
CA 19–9	S	0–37 kU/L	0–37 U/mL
CA 15–3	S	0–34 kU/L	0–34 U/mL
CA 27–29	S	0–40 kU/L	0–40 U/mL

(Continued)

## CLINICAL CHEMISTRY AND IMMUNOLOGY

ANALYTE	SPECIMEN <sup>a</sup>	SI UNITS	CONVENTIONAL UNITS
Calcitonin	S		
Male		3–26 ng/L	3–26 pg/mL
Female		2–17 ng/L	2–17 pg/mL
Calcium	S	2.2–2.6 mmol/L	8.7–10.2 mg/dL
Calcium, ionized	WB	1.12–1.32 mmol/L	4.5–5.3 mg/dL
Carbon dioxide content (TCO <sub>2</sub> )	P (sea level)	22–30 mmol/L	22–30 meq/L
Carboxyhemoglobin (carbon monoxide content)	WB		
Nonsmokers		0–0.04	0–4%
Smokers		0.04–0.09	4–9%
Onset of symptoms		0.15–0.20	15–20%
Loss of consciousness and death		>0.50	>50%
Carcinoembryonic antigen (CEA)	S		
Nonsmokers		0.0–3.0 µg/L	0.0–3.0 ng/mL
Smokers	S	0.0–5.0 µg/L	0.0–5.0 ng/mL
Ceruloplasmin	S	250–630 mg/L	25–63 mg/dL
Chloride	S	102–109 mmol/L	102–109 meq/L
Cholesterol: see <b>Table A-5</b>			
Cholinesterase	S	5–12 kU/L	5–12 U/mL
Complement			
C3	S	0.83–1.77 g/L	83–177 mg/dL
C4	S	0.16–0.47 g/L	16–47 mg/dL
Total hemolytic complement (CH50)	S	50–150%	50–150%
Factor B	S	0.17–0.42 g/L	17–42 mg/dL
Coproporphyrins (types I and III)	U	150–470 µmol/d	100–300 µg/d
Cortisol			
Fasting, 8 A.M.–12 noon	S	138–690 nmol/L	5–25 µg/dL
12 noon–8 P.M.		138–414 nmol/L	5–15 µg/dL
8 P.M.–8 A.M.		0–276 nmol/L	0–10 µg/dL
Cortisol, free	U	55–193 nmol/24 h	20–70 µg/24 h
C-reactive protein	S	0.2–3.0 mg/L	0.2–3.0 mg/L
Creatine kinase (total)	S		
Females		0.66–4.0 µkat/L	39–238 U/L
Males		0.87–5.0 µkat/L	51–294 U/L
Creatine kinase-MB	S		
Mass		0.0–5.5 µg/L	0.0–5.5 ng/mL
Fraction of total activity (by electrophoresis)		0–0.04	0–4.0%
Creatinine	S		
Female		44–80 µmol/L	0.5–0.9 ng/mL
Male		53–106 µmol/L	0.6–1.2 ng/mL
Cryoproteins	S	Not applicable	None detected
Dehydroepiandrosterone (DHEA) (adult)			
Male	S	6.2–43.4 nmol/L	180–1250 ng/dL
Female		4.5–34.0 nmol/L	130–980 ng/dL
Dehydroepiandrosterone (DHEA) sulfate	S		
Male (adult)		100–6190 µg/L	10–619 µg/dL
Female (adult, premenopausal)		120–5350 µg/L	12–535 µg/dL
Female (adult, postmenopausal)		300–2600 µg/L	30–260 µg/dL
Deoxycorticosterone (DOC) (adult)	S	61–576 nmol/L	2–19 ng/dL
11-Deoxycortisol (adult) (compound S) (8:00 A.M.)	S	0.34–4.56 nmol/L	12–158 ng/dL
Dihydrotestosterone			
Male	S, P	1.03–2.92 nmol/L	30–85 ng/dL
Female		0.14–0.76 nmol/L	4–22 ng/dL
Dopamine	P	<475 pmol/L	<87 pg/mL
Dopamine	U	425–2610 nmol/d	65–400 µg/d
Epinephrine	P		
Supine (30 min)		<273 pmol/L	<50 pg/mL
Sitting		<328 pmol/L	<60 pg/mL
Standing (30 min)		<491 pmol/L	<90 pg/mL

(Continued)

TABLE A-2 (CONTINUED)

CLINICAL CHEMISTRY AND IMMUNOLOGY			
ANALYTE	SPECIMEN <sup>a</sup>	SI UNITS	CONVENTIONAL UNITS
Epinephrine	U	0–109 nmol/d	0–20 µg/d
Erythropoietin	S	4–27 U/L	4–27 U/L
Estradiol	S, P		
Female			
Menstruating:			
Follicular phase		74–532 pmol/L	<20–145 pg/mL
Mid-cycle peak		411–1626 pmol/L	112–443 pg/mL
Luteal phase		74–885 pmol/L	<20–241 pg/mL
Postmenopausal		217 pmol/L	<59 pg/mL
Male		74 pmol/L	<20 pg/mL
Estrone	S, P		
Female			
Menstruating:			
Follicular phase		55–555 pmol/L	15–150 pg/mL
Luteal phase		55–740 pmol/L	15–200 pg/mL
Postmenopausal		55–204 pmol/L	15–55 pg/mL
Male		55–240 pmol/L	15–65 pg/mL
Fatty acids, free (nonesterified)	P	<0.28–0.89 mmol/L	<8–25 mg/dL
Ferritin	S		
Female		10–150 µg/L	10–150 ng/mL
Male		29–248 µg/L	29–248 ng/mL
Follicle-stimulating hormone (FSH)	S, P		
Female			
Menstruating:			
Follicular phase		3.0–20.0 IU/L	3.0–20.0 mIU/mL
Ovulatory phase		9.0–26.0 IU/L	9.0–26.0 mIU/mL
Luteal phase		1.0–12.0 IU/L	1.0–12.0 mIU/mL
Postmenopausal		18.0–153.0 IU/L	18.0–153.0 mIU/mL
Male		1.0–12.0 IU/L	1.0–12.0 mIU/mL
Free testosterone, adult			
Female	S	2.1–23.6 pmol/L	0.6–6.8 pg/mL
Male		163–847 pmol/L	47–244 pg/mL
Fructosamine	S	<285 µmol/L	<285 µmol/L
Gamma glutamyltransferase	S	0.15–0.99 µkat/L	9–58 U/L
Gastrin	S	<100 ng/L	<100 pg/mL
Glucagon	P	20–100 ng/L	20–100 pg/mL
Glucose (fasting)	P		
Normal		4.2–6.1 mmol/L	75–110 mg/dL
Impaired glucose tolerance		6.2–6.9 mmol/L	111–125 mg/dL
Diabetes mellitus		>7.0 mmol/L	>125 mg/dL
Glucose, 2 h postprandial	P	3.9–6.7 mmol/L	70–120 mg/dL
Growth hormone (resting)	S	0.5–17.0 µg/L	0.5–17.0 ng/mL
Hemoglobin A <sub>1c</sub>	WB	0.04–0.06 Hb fraction	4.0–6.0%
High-density lipoprotein (HDL) (see Table A-5)			
Homocysteine	P	4.4–10.8 µmol/L	4.4–10.8 µmol/L
Human chorionic gonadotropin (hCG)	S		
Nonpregnant female		<5 IU/L	<5 mIU/mL
1–2 weeks postconception		9–130 IU/L	9–130 mIU/mL
2–3 weeks postconception		75–2600 IU/L	75–2600 mIU/mL
3–4 weeks postconception		850–20,800 IU/L	850–20,800 mIU/mL
4–5 weeks postconception		4000–100,200 IU/L	4000–100,200 mIU/mL
5–10 weeks postconception		11,500–289,000 IU/L	11,500–289,000 mIU/mL
10–14 weeks postconception		18,300–137,000 IU/L	18,300–137,000 mIU/mL
Second trimester		1400–53,000 IU/L	1400–53,000 mIU/mL
Third trimester		940–60,000 IU/L	940–60,000 mIU/mL
β-Hydroxybutyrate	P	0–290 µmol/L	0–3 mg/dL
5-Hydroxyindoleacetic acid [5-HIAA]	U	10.5–36.6 µmol/d	2–7 mg/d

(Continued)

## CLINICAL CHEMISTRY AND IMMUNOLOGY

ANALYTE	SPECIMEN <sup>a</sup>	SI UNITS	CONVENTIONAL UNITS
17-Hydroxyprogesterone (adult)	S		
Male		0.15–7.5 nmol/L	5–250 ng/dL
Female			
Follicular phase		0.6–3.0 nmol/L	20–100 ng/dL
Midcycle peak		3–7.5 nmol/L	100–250 ng/dL
Luteal phase		3–15 nmol/L	100–500 ng/dL
Postmenopausal		≤2.1 nmol/L	≤70 ng/dL
Hydroxyproline	U, 24 hour	38–500 μmol/d	38–500 μmol/d
Immunofixation	S	Not applicable	No bands detected
Immunoglobulin, quantitation (adult)			
IgA	S	0.70–3.50 g/L	70–350 mg/dL
IgD	S	0–140 mg/L	0–14 mg/dL
IgE	S	24–430 μg/L	10–179 IU/mL
IgG	S	7.0–17.0 g/L	700–1700 mg/dL
IgG <sub>1</sub>	S	2.7–17.4 g/L	270–1740 mg/dL
IgG <sub>2</sub>	S	0.3–6.3 g/L	30–630 mg/dL
IgG <sub>3</sub>	S	0.13–3.2 g/L	13–320 mg/dL
IgG <sub>4</sub>	S	0.11–6.2 g/L	11–620 mg/dL
IgM	S	0.50–3.0 g/L	50–300 mg/dL
Insulin	S, P	14.35–143.5 pmol/L	2–20 μU/mL
Iron	S	7–25 μmol/L	41–141 μg/dL
Iron-binding capacity	S	45–73 μmol/L	251–406 μg/dL
Iron-binding capacity saturation	S	0.16–0.35	16–35%
Joint fluid crystal	JF	Not applicable	No crystals seen
Joint fluid mucin	JF	Not applicable	Only type I mucin present
Ketone (acetone)	S, U	Negative	Negative
17 Ketosteroids	U	0.003–0.012 g/d	3–12 mg/d
Lactate	P, arterial	0.5–1.6 mmol/L	4.5–14.4 mg/dL
	P, venous	0.5–2.2 mmol/L	4.5–19.8 mg/dL
Lactate dehydrogenase	S	2.0–3.8 μkat/L	115–221 U/L
Lactate dehydrogenase isoenzymes	S		
Fraction 1 (of total)		0.14–0.26	14–26%
Fraction 2		0.29–0.39	29–39%
Fraction 3		0.20–0.25	20–25%
Fraction 4		0.08–0.16	8–16%
Fraction 5		0.06–0.16	6–16%
Lipase (method dependent)	S	0.51–0.73 μkat/L	3–43 U/L
Lipids: see <b>Table A-5</b>			
Lipoprotein (a)	S	0–300 mg/L	0–30 mg/dL
Low-density lipoprotein (LDL) (see <b>Table A-5</b> )			
Luteinizing hormone (LH)	S, P		
Female			
Menstruating:			
Follicular phase		2.0–15.0 U/L	2.0–15.0 U/L
Ovulatory phase		22.0–105.0 U/L	22.0–105.0 U/L
Luteal phase		0.6–19.0 U/L	0.6–19.0 U/L
Postmenopausal		16.0–64.0 U/L	16.0–64.0 U/L
Male		2.0–12.0 U/L	2.0–12.0 U/L
Magnesium	S	0.62–0.95 mmol/L	1.5–2.3 mg/dL
Metanephrine	P	<0.5 nmol/L	<100 pg/mL
Metanephrine	U	30–211 mmol/mol creatinine	53–367 μg/g creatinine
Methemoglobin	WB	0.0–0.01	0–1%
Microalbumin urine	U		
24-h urine		0.0–0.03 g/d	0–30 mg/24 h
Spot urine		0.0–0.03 g/g creatinine	0–30 μg/mg creatinine
Myoglobin	S		
Male		19–92 μg/L	19–92 μg/L
Female		12–76 μg/L	12–76 μg/L

(Continued)

TABLE A-2 (CONTINUED)

CLINICAL CHEMISTRY AND IMMUNOLOGY			
ANALYTE	SPECIMEN <sup>a</sup>	SI UNITS	CONVENTIONAL UNITS
Norepinephrine	U	89–473 nmol/d	15–80 µg/d
Norepinephrine	P		
Supine (30 min)		650–2423 pmol/L	110–410 pg/mL
Sitting		709–4019 pmol/L	120–680 pg/mL
Standing (30 min)		739–4137 pmol/L	125–700 pg/mL
N-telopeptide (cross linked), NTx	S		
Female, premenopausal		6.2–19.0 nmol BCE	6.2–19.0 nmol BCE
Male		5.4–24.2 nmol BCE	5.4–24.2 nmol BCE
Bone collagen equivalent (BCE)			
N-telopeptide (cross linked), NTx	U		
Female, premenopausal		17–94 nmol BCE/mmol creatinine	17–94 nmol BCE/mmol creatinine
Female, postmenopausal		26–124 nmol BCE/mmol creatinine	26–124 nmol BCE/mmol creatinine
Male		21–83 nmol BCE/mmol creatinine	21–83 nmol BCE/mmol creatinine
Bone collagen equivalent (BCE)			
5' Nucleotidase	S	0.02–0.19 µkat/L	0–11 U/L
Osmolality	P	275–295 mOsmol/kg	275–295 mOsmol/kg
		serum water	serum water
	U	500–800 mOsmol/kg water	500–800 mOsmol/kg water
Osteocalcin	S	11–50 µg/L	11–50 ng/mL
Oxygen content	WB		
Arterial (sea level)		17–21	17–21 vol%
Venous (sea level)		10–16	10–16 vol%
Oxygen percent saturation (sea level)	WB		
Arterial		0.97	94–100%
Venous, arm		0.60–0.85	60–85%
Parathyroid hormone (intact)	S	8–51 ng/L	8–51 pg/mL
Phosphatase, alkaline	S	0.56–1.63 µkat/L	33–96 U/L
Phosphorus, inorganic	S	0.81–1.4 mmol/L	2.5–4.3 mg/dL
Porphobilinogen	U	None	None
Potassium	S	3.5–5.0 mmol/L	3.5–5.0 meq/L
Prealbumin	S	170–340 mg/L	17–34 mg/dL
Progesterone	S, P		
Female			
Follicular		<3.18 nmol/L	<1.0 ng/mL
Midluteal		9.54–63.6 nmol/L	3–20 ng/mL
Male		<3.18 nmol/L	<1.0 ng/mL
Prolactin	S	0–20 µg/L	0–20 ng/mL
Prostate-specific antigen (PSA)	S		
Male			
<40 years		0.0–2.0 µg/L	0.0–2.0 ng/mL
>40 years		0.0–4.0 µg/L	0.0–4.0 ng/mL
PSA, free; in males 45–75 years, with PSA values between 4 and 20 µg/mL	S	>0.25 associated with benign prostatic hyperplasia	>25% associated with benign prostatic hyperplasia
Protein fractions	S		
Albumin		35–55 g/L	3.5–5.5 g/dL (50–60%)
Globulin		20–35 g/L	2.0–3.5 g/dL (40–50%)
Alpha <sub>1</sub>		2–4 g/L	0.2–0.4 g/dL (4.2–7.2%)
Alpha <sub>2</sub>		5–9 g/L	0.5–0.9 g/dL (6.8–12%)
Beta		6–11 g/L	0.6–1.1 g/dL (9.3–15%)
Gamma		7–17 g/L	0.7–1.7 g/dL (13–23%)
Protein, total	S	67–86 g/L	6.7–8.6 g/dL
Pyruvate	P, arterial	40–130 µmol/L	0.35–1.14 mg/dL
	P, venous	40–130 µmol/L	0.35–1.14 mg/dL
Rheumatoid factor	S, JF	<30 kIU/L	<30 IU/mL

(Continued)



**CLINICAL CHEMISTRY AND IMMUNOLOGY**

ANALYTE	SPECIMEN <sup>a</sup>	SI UNITS	CONVENTIONAL UNITS
Serotonin	WB	0.28–1.14 µmol/L	50–200 ng/mL
Serum protein electrophoresis	S	Not applicable	Normal pattern
Sex hormone binding globulin (adult)	S		
Male		13–71 nmol/L	13–71 nmol/L
Female		18–114 nmol/L	18–114 nmol/L
Sodium	S	136–146 mmol/L	136–146 meq/L
Somatomedin-C (IGF-1) (adult)	S		
16–24 years		182–780 µg/L	182–780 ng/mL
25–39 years		114–492 µg/L	114–492 ng/mL
40–54 years		90–360 µg/L	90–360 ng/mL
>54 years		71–290 µg/L	71–290 ng/mL
Somatostatin	P	<25 ng/L	<25 pg/mL
Testosterone, total, morning sample	S		
Female		0.21–2.98 nmol/L	6–86 ng/dL
Male		9.36–37.10 nmol/L	270–1070 ng/dL
Thyroglobulin	S	0.5–53 µg/L	0.5–53 ng/mL
Thyroid-binding globulin	S	13–30 mg/L	1.3–3.0 mg/dL
Thyroid-stimulating hormone	S	0.34–4.25 mIU/L	0.34–4.25 µIU/mL
Thyroxine, free (fT <sub>4</sub> )	S	10.3–21.9 pmol/L	0.8–1.7 ng/dL
Thyroxine, total (T <sub>4</sub> )	S	70–151 nmol/L	5.4–11.7 µg/dL
(Free) thyroxine index	S	6.7–10.9	6.7–10.9
Transferrin	S	2.0–4.0 g/L	200–400 mg/dL
Triglycerides (see <b>Table A-5</b> )	S	0.34–2.26 mmol/L	30–200 mg/dL
Triiodothyronine, free (fT <sub>3</sub> )	S	3.7–6.5 pmol/L	2.4–4.2 pg/mL
Triiodothyronine, total (T <sub>3</sub> )	S	1.2–2.1 nmol/L	77–135 ng/dL
Troponin I	S		
Normal population, 99% tile		0–0.08 µg/L	0–0.08 ng/mL
Cut-off for MI		>0.4 µg/L	>0.4 ng/mL
Troponin T	S		
Normal population, 99% tile		0–0.1 µg/L	0–0.01 ng/mL
Cut-off for MI		0–0.1 µg/L	0–0.1 ng/mL
Urea nitrogen	S	2.5–7.1 mmol/L	7–20 mg/dL
Uric acid	S		
Females		0.15–0.33 µmol/L	2.5–5.6 mg/dL
Males		0.18–0.41 µmol/L	3.1–7.0 mg/dL
Urobilinogen	U	0.09–4.2 µmol/d	0.05–25 mg/24 h
Vanillylmandelic acid (VMA)	U, 24h	<30 µmol/d	<6 mg/d
Vasoactive intestinal polypeptide	P	0–60 ng/L	0–60 pg/mL

<sup>a</sup>P, plasma; S, serum; U, urine; WB, whole blood; JF, joint fluid.

**TABLE A-3****TOXICOLOGY AND THERAPEUTIC DRUG MONITORING**

DRUG	THERAPEUTIC RANGE		TOXIC LEVEL	
	SI UNITS	CONVENTIONAL UNITS	SI UNITS	CONVENTIONAL UNITS
Acetaminophen	66–199 µmol/L	10–30 µg/mL	>1320 µmol/L	>200 µg/mL
Amikacin				
Peak	34–51 µmol/L	20–30 µg/mL	>60 µmol/L	>35 µg/mL
Trough	0–17 µmol/L	0–10 µg/mL	>17 µmol/L	>10 µg/mL
Amitriptyline/Nortriptyline (Total Drug)	430–900 nmol/L	120–250 ng/mL	>1800 nmol/L	>500 ng/mL
Amphetamine	150–220 nmol/L	20–30 ng/mL	>1500 nmol/L	>200 ng/mL

(Continued)

TABLE A-3 (CONTINUED)

DRUG	THERAPEUTIC RANGE		TOXIC LEVEL	
	SI UNITS	CONVENTIONAL UNITS	SI UNITS	CONVENTIONAL UNITS
Bromide	1.3–6.3 mmol/L 9.4–18.8 mmol/L	Sedation: 10–50 mg/dL Epilepsy: 75–150 mg/dL	6.4–18.8 mmol/L >18.8 mmol/L >37.5 mmol/L	51–150 mg/dL: mild toxicity >150 mg/dL: Severe toxicity >300 mg/dL: Lethal >20 µg/mL
Carbamazepine	17–42 µmol/L	4–10 µg/mL	85 µmol/L	>20 µg/mL
Chloramphenicol				
Peak	31–62 µmol/L	10–20 µg/mL	>77 µmol/L	>25 µg/mL
Trough	15–31 µmol/L	5–10 µg/mL	>46 µmol/L	>15 µg/mL
Chlordiazepoxide	1.7–10 µmol/L	0.5–3.0 µg/mL	>17 µmol/L	>5.0 µg/mL
Clonazepam	32–240 nmol/L	10–75 ng/mL	>320 nmol/L	>100 ng/mL
Clozapine	0.6–2.1 µmol/L	200–700 ng/mL	>3.7 µmol/L	>1200 ng/mL
Cocaine			>3.3 µmol/L	>1.0 µg/mL
Codeine	43–110 nmol/mL	13–33 ng/mL	>3700 nmol/mL	>1100 ng/mL (lethal)
Cyclosporine				
Renal Transplant				
0–6 months	208–312 nmol/L	250–375 ng/mL	>312 nmol/L	>375 ng/mL
6–12 months after transplant	166–250 nmol/L	200–300 ng/mL	>250 nmol/L	>300 ng/mL
>12 months	83–125 nmol/L	100–150 ng/mL	>125 nmol/L	>150 ng/mL
Cardiac Transplant				
0–6 months	208–291 nmol/L	250–350 ng/mL	>291 nmol/L	>350 ng/mL
6–12 months after transplant	125–208 nmol/L	150–250 ng/mL	>208 nmol/L	>250 ng/mL
>12 months	83–125 nmol/L	100–150 ng/mL	>125 nmol/L	150 ng/mL
Lung Transplant				
0–6 months	250–374 nmol/L	300–450 ng/mL	>374 nmol/L	>450 ng/mL
Liver Transplant				
0–7 days	249–333 nmol/L	300–400 ng/mL	>333 nmol/L	>400 ng/mL
2–4 weeks	208–291 nmol/L	250–350 ng/mL	>291 nmol/L	>350 ng/mL
5–8 weeks	166–249 nmol/L	200–300 ng/mL	>249 nmol/L	>300 ng/mL
9–52 weeks	125–208 nmol/L	150–250 ng/mL	>208 nmol/L	>250 ng/mL
>1 year	83–166 nmol/L	100–200 ng/mL	>166 nmol/L	>200 ng/mL
Desipramine	375–1130 nmol/L	100–300 ng/mL	>1880 nmol/L	>500 ng/mL
Diazepam (and Metabolite)				
Diazepam	0.7–3.5 µmol/L	0.2–1.0 µg/mL	>7.0 µmol/L	>2.0 µg/mL
Nordazepam	0.4–6.6 µmol/L	0.1–1.8 µg/mL	>9.2 µmol/L	>2.5 µg/mL
Digoxin	0.64–2.6 nmol/L	0.5–2.0 ng/mL	>3.1 nmol/L	>2.4 ng/mL
Disopyramide	>7.4 µmol/L	2.5 µg/mL	20.6 µmol/L	>7 µg/mL
Doxepin and Nordoxepin				
Doxepin	0.36–0.98 µmol/L	101–274 ng/mL	>1.8 µmol/L	>503 ng/mL
Nordoxepin	0.38–1.04 µmol/L	106–291 ng/mL	>1.9 µmol/L	>531 ng/mL
Ethanol				
Behavioral changes			>4.3 mmol/L	>20 mg/dL
Legal limit			≥17 mmol/L	≥80 mg/dL
Critical with acute exposure			>54 mmol/L	>250 mg/dL
Ethylene Glycol				
Toxic			>2 mmol/L	>12 mg/dL
Lethal			>20 mmol/L	>120 mg/dL
Ethosuximide	280–700 µmol/L	40–100 µg/mL	>700 µmol/L	>100 µg/mL
Flecainide	0.5–2.4 µmol/L	0.2–1.0 µg/mL	>3.6 µmol/L	>1.5 µg/mL
Gentamicin				
Peak	10–21 µmol/mL	5–10 µg/mL	>25 µmol/mL	>12 µg/mL
Trough	0–4.2 µmol/mL	0–2 µg/mL	>4.2 µmol/mL	>2 µg/mL

(Continued)

## TOXICOLOGY AND THERAPEUTIC DRUG MONITORING

DRUG	THERAPEUTIC RANGE		TOXIC LEVEL	
	SI UNITS	CONVENTIONAL UNITS	SI UNITS	CONVENTIONAL UNITS
Heroin (Diacetyl Morphine)			>700 $\mu\text{mol/L}$	>200 ng/mL (as morphine)
Ibuprofen	49–243 $\mu\text{mol/L}$	10–50 $\mu\text{g/mL}$	>97 $\mu\text{mol/L}$	>200 $\mu\text{g/mL}$
Imipramine (and metabolite)				
Desimipramine	375–1130 nmol/L	100–300 ng/mL	>1880 nmol/L	>500 ng/mL
Total Imipramine + Desimipramine	563–1130 nmol/L	150–300 ng/mL	>1880 nmol/L	>500 ng/mL
Lidocaine	5.1–21.3 $\mu\text{mol/L}$	1.2–5.0 $\mu\text{g/mL}$	>38.4 $\mu\text{mol/L}$	>9.0 $\mu\text{g/mL}$
Lithium	0.5–1.3 meq/L	0.5–1.3 meq/L	>2 mmol/L	>2 meq/L
Methadone	1.3–3.2 $\mu\text{mol/L}$	0.4–1.0 $\mu\text{g/mL}$	>6.5 $\mu\text{mol/L}$	>2 $\mu\text{g/mL}$
Methamphetamine		20–30 ng/mL		0.1–1.0 $\mu\text{g/mL}$
Methanol			>6 mmol/L	>20 mg/dL
			>16 mmol/L	>50 mg/dL Severe Toxicity
			>28 mmol/L	>89 mg/dL Lethal
Methotrexate				
Low dose	0.01–0.1 $\mu\text{mol/L}$	0.01–0.1 $\mu\text{mol/L}$	>0.1 mmol/L	>0.1 mmol/L
High dose (24 h)	<5.0 $\mu\text{mol/L}$	<5.0 $\mu\text{mol/L}$	>5.0 $\mu\text{mol/L}$	>5.0 $\mu\text{mol/L}$
High-dose (48 h)	<0.50 $\mu\text{mol/L}$	<0.50 $\mu\text{mol/L}$	>0.5 $\mu\text{mol/L}$	>0.5 $\mu\text{mol/L}$
High-dose (72 h)	<0.10 $\mu\text{mol/L}$	<0.10 $\mu\text{mol/L}$	>0.1 $\mu\text{mol/L}$	>0.1 $\mu\text{mol/L}$
Morphine	35–250 $\mu\text{mol/L}$	10–70 ng/mL	180–14000 $\mu\text{mol/L}$	50–4000 ng/mL
Nitroprusside (as thiocyanate)	103–499 $\mu\text{mol/L}$	6–29 $\mu\text{g/mL}$	860 $\mu\text{mol/L}$	>50 $\mu\text{g/mL}$
Nortriptyline	190–569 nmol/L	50–150 ng/mL	>1900 nmol/L	>500 ng/mL
Phenobarbital	65–172 $\mu\text{mol/L}$	15–40 $\mu\text{g/mL}$	>215 $\mu\text{mol/L}$	>50 $\mu\text{g/mL}$
Phenytoin	40–79 $\mu\text{mol/L}$	10–20 $\mu\text{g/mL}$	>118 $\mu\text{mol/L}$	>30 $\mu\text{g/mL}$
Phenytoin, Free % Free	4.0–7.9 $\mu\text{g/mL}$ 0.08–0.14	1–2 $\mu\text{g/mL}$ 8–14 %	>13.9 $\mu\text{g/mL}$	>3.5 $\mu\text{g/mL}$
Primidone and Metabolite				
Primidone	23–55 $\mu\text{mol/L}$	5–12 $\mu\text{g/mL}$	>69 $\mu\text{mol/L}$	>15 $\mu\text{g/mL}$
Phenobarbital	65–172 $\mu\text{mol/L}$	15–40 $\mu\text{g/mL}$	>215 $\mu\text{mol/L}$	>50 $\mu\text{g/mL}$
Procainamide				
Procainamide	17–42 $\mu\text{mol/L}$	4–10 $\mu\text{g/mL}$	>51 $\mu\text{mol/L}$	>12 $\mu\text{g/mL}$
NAPA (N-acetylprocainamide)	22–72 $\mu\text{mol/L}$	6–20 $\mu\text{g/mL}$	>126 $\mu\text{mol/L}$	>35 $\mu\text{g/mL}$
Quinidine	>6.2–15.4 $\mu\text{mol/L}$	2.0–5.0 $\mu\text{g/mL}$	>31 $\mu\text{mol/L}$	>10 $\mu\text{g/mL}$
Salicylates	145–2100 $\mu\text{mol/L}$	2–29 mg/dL	>2172 $\mu\text{mol/L}$	>30 mg/dL
Sirolimus (Trough Level)				
Kidney Transplant	4.4–13.1 nmol/L	4–12 ng/mL	>16 nmol/L	>15 ng/mL
Tacrolimus (FK506) (trough)				
Kidney and Liver				
0–2 months post transplant	12–19 nmol/L	10–15 ng/mL	>25 nmol/L	>20 ng/mL
>2 months post transplant	6–12 nmol/L	5–10 ng/mL		
Heart				
0–2 months post transplant	19–25 nmol/L	15–20 ng/mL	>25 nmol/L	>20 ng/mL
3–6 months post transplant	12–19 nmol/L	10–15 ng/mL		
>6 months post transplant	10–12 nmol/L	8–10 ng/mL		
Theophylline	56–111 $\mu\text{g/mL}$	10–20 $\mu\text{g/mL}$	>140 $\mu\text{g/mL}$	>25 $\mu\text{g/mL}$
Thiocyanate				
After nitroprusside infusion	103–499 $\mu\text{mol/L}$	6–29 $\mu\text{g/mL}$	860 $\mu\text{mol/L}$	>50 $\mu\text{g/mL}$
Nonsmoker	17–69 $\mu\text{mol/L}$	1–4 $\mu\text{g/mL}$		
Smoker	52–206 $\mu\text{mol/L}$	3–12 $\mu\text{g/mL}$		

(Continued)

TABLE A-3 (CONTINUED)

DRUG	THERAPEUTIC RANGE		TOXIC LEVEL	
	SI UNITS	CONVENTIONAL UNITS	SI UNITS	CONVENTIONAL UNITS
Tobramycin				
Peak	11–22 µg/L	5–10 µg/mL	>26 µg/L	>12 µg/mL
Trough	0–4.3 µg/L	0–2 µg/mL	>4.3 µg/L	>2 µg/mL
Valproic acid	350–700 µmol/L	50–100 µg/mL	>1000 µmol/L	>150 µg/mL
Vancomycin				
Peak	14–28 µmol/L	20–40 µg/mL	>55 µmol/L	>80 µg/mL
Trough	3.5–10.4 µmol/L	5–15 µg/mL	>14 µmol/L	>20 µg/mL

TABLE A-4

SPECIMEN	ANALYTE <sup>a</sup>	REFERENCE RANGE	
		SI UNITS	CONVENTIONAL UNITS
Aluminum	S	<0.2 µmol/L	<5.41 µg/L
	U, random	0.19–1.11 µmol/L	5–30 µg/L
Arsenic	WB	0.03–0.31 µmol/L	2–23 µg/L
	U, 24 h	0.07–0.67 µmol/d	5–50 µg/d
Cadmium	WB	<44.5 nmol/L	<5.0 µg/L
Coenzyme Q10 (ubiquinone)	P	433–1532 µg/L	433–1532 µg/L
B carotene	S	0.07–1.43 µmol/L	4–77 µg/dL
Copper	S	11–22 µmol/L	70–140 µg/dL
	U, 24 h	<0.95 µmol/d	<60 µg/d
Folic acid	RC	340–1020 nmol/L cells	150–450 ng/mL cells
Folic acid	S	12.2–40.8 nmol/L	5.4–18.0 ng/mL
Lead (adult)	S	<0.5 µmol/L	<10 µg/dL
Mercury	WB	3.0–294 nmol/L	0.6–59 µg/L
	U, 24 h	<99.8 nmol/L	<20 µg/L
Selenium	S	0.8–2.0 µmol/L	63–160 µg/L
Vitamin A	S	0.7–3.5 µmol/L	20–100 µg/dL
Vitamin B <sub>1</sub> (thiamine)	S	0–75 nmol/L	0–2 µg/dL
Vitamin B <sub>2</sub> (riboflavin)	S	106–638 nmol/L	4–24 µg/dL
Vitamin B <sub>6</sub>	P	20–121 nmol/L	5–30 ng/mL
Vitamin B <sub>12</sub>	S	206–735 pmol/L	279–996 pg/mL
Vitamin C (ascorbic acid)	S	23–57 µmol/L	0.4–1.0 mg/dL
Vitamin D <sub>3</sub> , 1,25-dihydroxy	S	60–108 pmol/L	25–45 pg/mL
Vitamin D <sub>3</sub> , 25-hydroxy	P		
Summer		37.4–200 nmol/L	15–80 ng/mL
Winter		34.9–105 nmol/L	14–42 ng/mL
Vitamin E	S	12–42 µmol/L	5–18 µg/mL
Vitamin K	S	0.29–2.64 nmol/L	0.13–1.19 ng/mL
Zinc	S	11.5–18.4 µmol/L	75–120 µg/dL

<sup>a</sup>P, plasma; RC, red cells; S, serum; WB, whole blood; U, urine.

**TABLE A-5**

CLASSIFICATION OF LDL, TOTAL, AND HDL CHOLESTEROL	
<b>LDL Cholesterol, mg/dL (mmol/L)</b>	
<70 (<1.81)	Therapeutic option for very high risk patients
<100 (<2.59)	Optimal
100–129 (2.59–3.34)	Near optimal/above optimal
130–159 (3.36–4.11)	Borderline high
160–189 (4.14–4.89)	High
≥190 (≥4.91)	Very high
<b>Total Cholesterol, mg/dL (mmol/L)</b>	
<200 (<5.17)	Desirable
200–239 (5.17–6.18)	Borderline high
≥240 (≥6.21)	High
<b>HDL Cholesterol, mg/dL (mmol/L)</b>	
<40 (<1.03)	Low
≥60 (≥1.55)	High

**Note:** LDL, low-density lipoprotein; HDL, high-density lipoprotein.

**Source:** Executive summary of the third report of the National Cholesterol Education Program (NCEP) expert panel on detection, evaluation, and treatment of high blood cholesterol in adults (adult treatment panel III). JAMA 285:2486, 2001; and Implications of recent clinical trials for the National Cholesterol Education Program Adult Treatment Panel III Guidelines: SM Grundy et al for the Coordinating Committee of the National Cholesterol Education Program. Circulation 110:227, 2004.

## REFERENCE VALUES FOR SPECIFIC ANALYTES

**TABLE A-6**

CONSTITUENT	REFERENCE RANGE	
	SI UNITS	CONVENTIONAL UNITS
Osmolarity	292–297 mmol/kg water	292–297 mosmol/L
Electrolytes		
Sodium	137–145 mmol/L	137–145 meq/L
Potassium	2.7–3.9 mmol/L	2.7–3.9 meq/L
Calcium	1.0–1.5 mmol/L	2.1–3.0 meq/L
Magnesium	1.0–1.2 mmol/L	2.0–2.5 meq/L
Chloride	116–122 mmol/L	116–122 meq/L
CO <sub>2</sub> content	20–24 mmol/L	20–24 meq/L
Pco <sub>2</sub>	6–7 kPa	45–49 mmHg
pH	7.31–7.34	
Glucose	2.22–3.89 mmol/L	40–70 mg/dL
Lactate	1–2 mmol/L	10–20 mg/dL
Total protein		
Lumbar	0.15–0.5 g/L	15–50 mg/dL
Cisternal	0.15–0.25 g/L	15–25 mg/dL
Ventricular	0.06–0.15 g/L	6–15 mg/dL
Albumin	0.066–0.442 g/L	6.6–44.2 mg/dL
IgG	0.009–0.057 g/L	0.9–5.7 mg/dL
IgG index <sup>b</sup>	0.29–0.59	
Oligoclonal bands	<2 bands not present in matched serum sample	
Ammonia	15–47 μmol/L	25–80 μg/dL
Creatinine	44–168 μmol/L	0.5–1.9 mg/dL
Myelin basic protein	<4 μg/L	
CSF pressure		50–180 mmH <sub>2</sub> O
CSF volume (adult)	~150 mL	

(Continued)

**TABLE A-6 (CONTINUED)**

CONSTITUENT	REFERENCE RANGE	
	SI UNITS	CONVENTIONAL UNITS
Red blood cells	0	0
Leukocytes		
Total	0–5 mononuclear cells per $\mu\text{L}$	0–5 mononuclear cells per $\text{mm}^3$
Differential		
Lymphocytes	60–70%	
Monocytes	30–50%	
Neutrophils	None	

<sup>a</sup>Because cerebrospinal fluid concentrations are equilibrium values, measurements of the same parameters in blood plasma obtained at the same time are recommended. However, there is a time lag in attainment of equilibrium, and cerebrospinal levels of plasma constituents that can fluctuate rapidly (such as plasma glucose) may not achieve stable values until after a significant lag phase.

<sup>b</sup>IgG index =  $\text{CSF IgG}(\text{mg/dL}) \times \text{serum albumin}(\text{g/dL}) / \text{Serum IgG}(\text{g/dL}) \times \text{CSF albumin}(\text{mg/dL})$ .

**TABLE A-7**

	REFERENCE RANGE	
	SI UNITS	CONVENTIONAL UNITS
Acidity, titratable	20–40 mmol/d	20–40 meq/d
Ammonia	30–50 mmol/d	30–50 meq/d
Amylase		4–400 U/L
Amylase/creatinine clearance ratio $[(\text{Cl}_{\text{am}}/\text{Cl}_{\text{cr}}) \times 100]$	1–5	1–5
Calcium (10 meq/d or 200 mg/d dietary calcium)	<7.5 mmol/d	<300 mg/d
Creatine, as creatinine		
Female	<760 $\mu\text{mol/d}$	<100 mg/d
Male	<380 $\mu\text{mol/d}$	<50 mg/d
Creatinine	8.8–14 mmol/d	1.0–1.6 g/d
Eosinophils	<100,000 eosinophils/L	<100 eosinophils/mL
Glucose (glucose oxidase method)	0.3–1.7 mmol/d	50–300 mg/d
5-Hydroxyindoleacetic acid (5-HIAA)	10–47 $\mu\text{mol/d}$	2–9 mg/d
Iodine, spot urine		
WHO classification of iodine deficiency		
Not iodine deficient	>100 $\mu\text{g/L}$	>100 $\mu\text{g/L}$
Mild iodine deficiency	50–100 $\mu\text{g/L}$	50–100 $\mu\text{g/L}$
Moderate iodine deficiency	20–49 $\mu\text{g/L}$	20–49 $\mu\text{g/L}$
Severe iodine deficiency	<20 $\mu\text{g/L}$	<20 $\mu\text{g/L}$
Microalbumin		
Normal	0.0–0.03 g/d	0–30 mg/d
Microalbuminuria	0.03–0.30 g/d	30–300 mg/d
Clinical albuminuria	>0.3 g/d	>300 mg/d
Microalbumin/creatinine ratio		
Normal	0–3.4 g/mol creatinine	0–30 $\mu\text{g/mg}$ creatinine
Microalbuminuria	3.4–34 g/mol creatinine	30–300 $\mu\text{g/mg}$ creatinine
Clinical albuminuria	>34 g/mol creatinine	>300 $\mu\text{g/mg}$ creatinine

(Continued)

TABLE A-7 (CONTINUED)

	REFERENCE RANGE	
	SI UNITS	CONVENTIONAL UNITS
Oxalate		
Male	80–500 µmol/d	7–44 mg/d
Female	45–350 µmol/d	4–31 mg/d
pH	5.0–9.0	5.0–9.0
Phosphate (phosphorus) (varies with intake)	12.9–42.0 mmol/d	400–1300 mg/d
Potassium (varies with intake)	25–100 mmol/d	25–100 meq/d
Protein	<0.15 g/d	<150 mg/d
Sediment		
Red blood cells	0–2/high power field	
White blood cells	0–2/high power field	
Bacteria	None	
Crystals	None	
Bladder cells	None	
Squamous cells	None	
Tubular cells	None	
Broad casts	None	
Epithelial cell casts	None	
Granular casts	None	
Hyaline casts	0–5/low power field	
Red blood cell casts	None	
Waxy casts	None	
White cell casts	None	
Sodium (varies with intake)	100–260 mmol/d	100–260 meq/d
Specific gravity	1.001–1.035	1.001–1.035
Urea nitrogen	214–607 mmol/d	6–17 g/d
Uric acid (normal diet)	1.49–4.76 mmol/d	250–800 mg/d

Note: WHO, World Health Organization.

TABLE A-8

DIFFERENTIAL NUCLEATED CELL COUNTS OF BONE MARROW ASPIRATES<sup>a</sup>

	OBSERVED RANGE, %	95% CONFIDENCE INTERVALS, %	MEAN, %
Blast cells	0–3.2	0–3.0	1.4
Promyelocytes	3.6–13.2	3.2–12.4	7.8
Neutrophil myelocytes	4–21.4	3.7–10.0	7.6
Eosinophil myelocytes	0–5.0	0–2.8	1.3
Metamyelocytes	1–7.0	2.3–5.9	4.1
Neutrophils			
Males	21.0–45.6	21.9–42.3	32.1
Females	29.6–46.6	28.8–45.9	37.4
Eosinophils	0.4–4.2	0.3–4.2	2.2
Eosinophils plus eosinophil myelocytes	0.9–7.4	0.7–6.3	3.5
Basophils	0–0.8	0–0.4	0.1
Erythroblasts			
Males	18.0–39.4	16.2–40.1	28.1
Females	14.0–31.8	13.0–32.0	22.5
Lymphocytes	4.6–22.6	6.0–20.0	13.1
Plasma cells	0–1.4	0–1.2	0.6
Monocytes	0–3.2	0–2.6	1.3
Macrophages	0–1.8	0–1.3	0.4
M:E ratio			
Males	1.1–4.0	1.1–4.1	2.1
Females	1.6–5.4	1.6–5.2	2.8

<sup>a</sup>Based on bone marrow aspirate from 50 healthy volunteers (30 men, 20 women).

Source: From BJ Bain: The bone marrow aspirate of healthy subjects. Br J Haematol 94(1):206, 1996.

TABLE A-9

## STOOL ANALYSIS

	REFERENCE RANGE	
	SI UNITS	CONVENTIONAL UNITS
Amount	0.1–0.2 kg/d	100–200 g/24 h
Coproporphyrin	611–1832 nmol/d	400–1200 µg/24 h
Fat		
Adult		<7 g/d
Adult on fat-free diet		<4 g/d
Fatty acids	0–21 mmol/d	0–6 g/24 h
Leukocytes	None	None
Nitrogen	<178 mmol/d	<2.5 g/24 h
pH	7.0–7.5	
Occult blood	Negative	Negative
Trypsin		20–95 U/g
Urobilinogen	85–510 µmol/d	50–300 mg/24 h
Uroporphyrins	12–48 nmol/d	10–40 µg/24 h
Water	<0.75	<75%

**Source:** Modified from FT Fishbach, MB Dunning III: *A Manual of Laboratory and Diagnostic Tests*, 7th ed., Lippincott Williams & Wilkins, Philadelphia, 2004.

## SPECIAL FUNCTION TESTS

TABLE A-10

## RENAL FUNCTION TESTS

	REFERENCE RANGE	
	SI UNITS	CONVENTIONAL UNITS
Clearances (corrected to 1.72 m <sup>2</sup> body surface area)		
Measures of glomerular filtration rate		
Inulin clearance (Cl)		
Males (mean ± 1 SD)	2.1 ± 0.4 mL/s	124 ± 25.8 mL/min
Females (mean ± 1 SD)	2.0 ± 0.2 mL/s	119 ± 12.8 mL/min
Endogenous creatinine clearance	1.5–2.2 mL/s	91–130 mL/min
Measures of effective renal plasma flow and tubular function		
<p>-Aminohippuric acid clearance (Cl<sub>PAH</sub>)</p>		
Males (mean ± 1 SD)	10.9 ± 2.7 mL/s	654 ± 163 mL/min
Females (mean ± 1 SD)	9.9 ± 1.7 mL/s	594 ± 102 mL/min
Concentration and dilution test		
Specific gravity of urine		
After 12-h fluid restriction	>1.025	>1.025
After 12-h deliberate water intake	≤1.003	≤1.003
Protein excretion, urine	<0.15 g/d	<150 mg/d
Specific gravity, maximal range	1.002–1.028	1.002–1.028
Tubular reabsorption, phosphorus	0.79–0.94 of filtered load	79–94% of filtered load



TABLE A-11

## CIRCULATORY FUNCTION TESTS

## RESULTS: REFERENCE RANGE

TEST	SI UNITS (RANGE)	CONVENTIONAL UNITS (RANGE)
Arteriovenous oxygen difference	30–50 mL/L	30–50 mL/L
Cardiac output (Fick)	2.5–3.6 L/m <sup>2</sup> of body surface area per min	2.5–3.6 L/m <sup>2</sup> of body surface area per min
Contractility indexes		
Max. left ventricular $dp/dt(dp/dt)/DP$ when $DP = 5.3$ kPa (40 mmHg) (DP, diastolic pressure)	220 kPa/s (176–250 kPa/s) (37.6 ± 12.2)/s	1650 mmHg/s (1320–1880 mmHg/s) (37.6 ± 12.2)/s
Mean normalized systolic ejection rate (angiography)	3.32 ± 0.84 end-diastolic volumes per second	3.32 ± 0.84 end-diastolic volumes per second
Mean velocity of circumferential fiber shortening (angiography)	1.83 ± 0.56 circumferences per second	1.83 ± 0.56 circumferences per second
Ejection fraction: stroke volume/end-diastolic volume (SV/EDV)	0.67 ± 0.08 (0.55–0.78)	0.67 ± 0.08 (0.55–0.78)
End-diastolic volume	70 ± 20.0 mL/m <sup>2</sup> (60–88 mL/m <sup>2</sup> )	70 ± 20.0 mL/m <sup>2</sup> (60–88 mL/m <sup>2</sup> )
End-systolic volume	25 ± 5.0 mL/m <sup>2</sup> (20–33 mL/m <sup>2</sup> )	25 ± 5.0 mL/m <sup>2</sup> (20–33 mL/m <sup>2</sup> )
Left ventricular work		
Stroke work index	50 ± 20.0 (g·m)/m <sup>2</sup> (30–110)	50 ± 20.0 (g·m)/m <sup>2</sup> (30–110)
Left ventricular minute work index	1.8–6.6 [(kg·m)/m <sup>2</sup> ]/min	1.8–6.6 [(kg·m)/m <sup>2</sup> ]/min
Oxygen consumption index	110–150 mL	110–150 mL
Maximum oxygen uptake	35 mL/min (20–60 mL/min)	35 mL/min (20–60 mL/min)
Pulmonary vascular resistance	2–12 (kPa·s)/L	20–130 (dyn·s)/cm <sup>5</sup>
Systemic vascular resistance	77–150 (kPa·s)/L	770–1600 (dyn·s)/cm <sup>5</sup>

Source: E Braunwald et al: *Heart Disease*, 6th ed, Philadelphia, Saunders, 2001.

TABLE A-12

## GASTROINTESTINAL TESTS

## RESULTS

TEST	SI UNITS	CONVENTIONAL UNITS
Absorption tests		
D-Xylose: after overnight fast, 25 g xylose given in oral aqueous solution		
Urine, collected for following 5 h	25% of ingested dose	25% of ingested dose
Serum, 2 h after dose	2.0–3.5 mmol/L	30–52 mg/dL
Vitamin A: a fasting blood specimen is obtained and 200,000 units of vitamin A in oil is given orally	Serum level should rise to twice fasting level in 3–5 h	Serum level should rise to twice fasting level in 3–5 h
Bentiromide test (pancreatic function): 500 mg bentiromide (Chymex) orally; <i>p</i> -aminobenzoic acid (PABA) measured		
Plasma		>3.6 (±1.1) µg/mL at 90 min
Urine	>50% recovered in 6 h	>50% recovered in 6 h
Gastric juice		
Volume		
24 h	2–3 L	2–3 L
Nocturnal	600–700 mL	600–700 mL
Basal, fasting	30–70 mL/h	30–70 mL/h
Reaction		
pH	1.6–1.8	1.6–1.8
Titratable acidity of fasting juice	4–9 µmol/s	15–35 meq/h

(Continued)

TABLE A-12 (CONTINUED)

TEST	RESULTS	
	SI UNITS	CONVENTIONAL UNITS
Acid output		
Basal		
Females (mean ± 1 SD)	0.6 ± 0.5 μmol/s	2.0 ± 1.8 meq/h
Males (mean ± 1 SD)	0.8 ± 0.6 μmol/s	3.0 ± 2.0 meq/h
Maximal (after SC histamine acid phosphate, 0.004 mg/kg body weight, and preceded by 50 mg promethazine, or after betazole, 1.7 mg/kg body weight, or pentagastrin, 6 μg/kg body weight)		
Females (mean ± 1 SD)	4.4 ± 1.4 μmol/s	16 ± 5 meq/h
Males (mean ± 1 SD)	6.4 ± 1.4 μmol/s	23 ± 5 meq/h
Basal acid output/maximal acid output ratio	≤0.6	≤0.6
Gastrin, serum	0–200 μg/L	0–200 pg/mL
Secretin test (pancreatic exocrine function): 1 unit/kg body weight, IV		
Volume (pancreatic juice) in 80 min	>2.0 mL/kg	>2.0 mL/kg
Bicarbonate concentration	>80 mmol/L	>80 meq/L
Bicarbonate output in 30 min	>10 mmol	>10 meq

TABLE A-13

### NORMAL VALUES OF DOPPLER ECHOCARDIOGRAPHIC MEASUREMENTS IN ADULTS

	RANGE	MEAN
RVD (cm), measured at the base in apical 4-chamber view	2.6–4.3	3.5 ± 0.4
LVID (cm), measured in the parasternal long axis view	3.6–5.4	4.7 ± 0.4
Posterior LV wall thickness (cm)	0.6–1.1	0.9 ± 0.4
IVS wall thickness (cm)	0.6–1.1	0.9 ± 0.4
Left atrial dimension (cm), anteroposterior dimension	2.3–3.8	3.0 ± 0.3
Aortic root dimension (cm)	2.0–3.5	2.4 ± 0.4
Aortic cusps separation (cm)	1.5–2.6	1.9 ± 0.4
Percentage of fractional shortening	34–44%	36%
Mitral flow (m/s)	0.6–1.3	0.9
Tricuspid flow (m/s)	0.3–0.7	0.5
Pulmonary artery (m/s)	0.6–0.9	0.75
Aorta (m/s)	1.0–1.7	1.35

**Note:** RVD, right ventricular dimension; LVID, left ventricular internal dimension; LV, left ventricle; IVS, interventricular septum.

**Source:** From A Weyman: *Principles and Practice of Echocardiography*, 2d ed., Philadelphia, Lea & Febiger, 1994.

## TYPICAL VALUES

	SYMBOL	TYPICAL VALUES	
		MAN, AGE 40, 75 kg, 175 cm TALL	WOMAN, AGE 40, 60 kg, 160 cm TALL
<b>Pulmonary Mechanics</b>			
Spirometry—volume-time curves			
Forced vital capacity	FVC	5.1 L	3.6 L
Forced expiratory volume in 1 s	FEV <sub>1</sub>	4.1 L	2.9 L
FEV <sub>1</sub> /FVC	FEV <sub>1</sub> %	80%	82%
Maximal midexpiratory flow	MMF (FEF 25–27)	4.8 L/s	3.6 L/s
Maximal expiratory flow rate	MEFR (FEF 200–1200)	9.4 L/s	6.1 L/s
Spirometry—flow-volume curves			
Maximal expiratory flow at 50% of expired vital capacity	V <sub>max</sub> 50 (FEF 50%)	6.1 L/s	4.6 L/s
Maximal expiratory flow at 75% of expired vital capacity	V <sub>max</sub> 75 (FEF 75%)	3.1 L/s	2.5 L/s
Resistance to airflow			
Pulmonary resistance	RL (R <sub>L</sub> )	<3.0 (cmH <sub>2</sub> O/s)/L	
Airway resistance	Raw	<2.5 (cmH <sub>2</sub> O/s)/L	
Specific conductance	SGaw	>0.13 cmH <sub>2</sub> O/s	
Pulmonary compliance			
Static recoil pressure at total lung capacity	P <sub>st</sub> TLC	25 ± 5 cmH <sub>2</sub> O	
Compliance of lungs (static)	CL	0.2 L cmH <sub>2</sub> O	
Compliance of lungs and thorax	C(L + T)	0.1 L cmH <sub>2</sub> O	
Dynamic compliance of 20 breaths per minute	C <sub>dyn</sub> 20	0.25 ± 0.05 L/cmH <sub>2</sub> O	
Maximal static respiratory pressures			
Maximal inspiratory pressure	MIP	>90 cmH <sub>2</sub> O	>50 cmH <sub>2</sub> O
Maximal expiratory pressure	MEP	>150 cmH <sub>2</sub> O	>120 cmH <sub>2</sub> O
<b>Lung Volumes</b>			
Total lung capacity	TLC	6.7 L	4.9 L
Functional residual capacity	FRC	3.7 L	2.8 L
Residual volume	RV	2.0 L	1.6 L
Inspiratory capacity	IC	3.3 L	2.3 L
Expiratory reserve volume	ERV	1.7 L	1.1 L
Vital capacity	VC	5.0 L	3.4 L
<b>Gas Exchange (Sea Level)</b>			
Arterial O <sub>2</sub> tension	Pa <sub>O2</sub>	12.7 ± 0.7 kPa (95 ± 5 mmHg)	
Arterial CO <sub>2</sub> tension	Pa <sub>CO2</sub>	5.3 ± 0.3 kPa (40 ± 2 mmHg)	
Arterial O <sub>2</sub> saturation	Sa <sub>O2</sub>	0.97 ± 0.02 (97 ± 2%)	
Arterial blood pH	pH	7.40 ± 0.02	
Arterial bicarbonate	HCO <sub>3</sub> <sup>-</sup>	24 + 2 meq/L	
Base excess	BE	0 ± 2 meq/L	
Diffusing capacity for carbon monoxide (single breath)	DL <sub>CO</sub>	0.42 mL CO/s per mmHg (25 mL CO/min per mmHg)	
Dead space volume	V <sub>D</sub>	2 mL/kg body wt	
Physiologic dead space; dead space-tidal volume ratio	V <sub>D</sub> /V <sub>T</sub>		
Rest		≤35% V <sub>T</sub>	
Exercise		≤20% V <sub>T</sub>	
Alveolar-arterial difference for O <sub>2</sub>	P(A - a) <sub>O2</sub>	≤2.7 kPa ≤20 kPa (≤20 mmHg)	

## MISCELLANEOUS

TABLE A-15

## BODY FLUIDS AND OTHER MASS DATA

	REFERENCE RANGE	
	SI UNITS	CONVENTIONAL UNITS
Ascitic fluid		
Body fluid		
Total volume (lean) of body weight	50% (in obese) to 70%	
Intracellular	0.3–0.4 of body weight	
Extracellular	0.2–0.3 of body weight	
Blood		
Total volume		
Males	69 mL per kg body weight	
Females	65 mL per kg body weight	
Plasma volume		
Males	39 mL per kg body weight	
Females	40 mL per kg body weight	
Red blood cell volume		
Males	30 mL per kg body weight	1.15–1.21 L/m <sup>2</sup> of body surface area
Females	25 mL per kg body weight	0.95–1.00 L/m <sup>2</sup> of body surface area
Body mass index	18.5–24.9 kg/m <sup>2</sup>	18.5–24.9 kg/m <sup>2</sup>

TABLE A-16

## RADIATION-DERIVED UNITS

QUANTITY	OLD UNIT	SI UNIT	NAME FOR SI UNIT (AND ABBREVIATION)	CONVERSION
Activity	curie (Ci)	Disintegrations per second (dps)	becquerel (Bq)	1 Ci = $3.7 \times 10^{10}$ Bq 1 mCi = 37 mBq 1 $\mu$ Ci = 0.037 MBq or 37 GBq 1 Bq = $2.703 \times 10^{-11}$ Ci
Absorbed dose	rad	joule per kilogram (J/kg)	gray (Gy)	1 Gy = 100 rad 1 rad = 0.01 Gy 1 mrad = $10^{-3}$ cGy
Exposure	roentgen (R)	coulomb per kilogram (C/kg)	—	1 C/kg = 3876 R 1 R = $2.58 \times 10^{-4}$ C/kg 1 mR = 258 pC/kg
Dose equivalent	rem	joule per kilogram (J/kg)	sievert (Sv)	1 Sv = 100 rem 1 rem = 0.01 Sv 1 mrem = 10 $\mu$ Sv

## ACKNOWLEDGMENT

The authors acknowledge the contributions of Dr. Patrick M. Sluss, Dr. James L. Januzzi, and Dr. Kent B. Lewandrowski to this chapter in previous editions of *Harrison's Principles of Internal Medicine*.

## FURTHER READINGS

KRATZ A et al: Case records of the Massachusetts General Hospital. Weekly clinicopathological exercises. Laboratory reference values. *N Engl J Med* 351:1548, 2004

LEHMAN HP, HENRY JB: SI units, in *Henry's Clinical Diagnosis and Management by Laboratory Methods*, 21st ed, RC McPherson, MR Pincus (eds). Philadelphia, Elsevier Saunders, 2007, pp 1404–1418

PESCE MA: Reference ranges for laboratory tests and procedures, in *Nelson's Textbook of Pediatrics*, 18th ed, RM Kliegman et al (eds). Philadelphia, Elsevier Saunders, 2007, pp 2943–2949

SOLBERG HE: Establishment and use of reference values, in *Tietz Textbook of Clinical Chemistry and Molecular Diagnostics*, 4th ed, CA Burtis et al (eds). Philadelphia, Elsevier Saunders, 2006, pp 425–448

*This page intentionally left blank*

# REVIEW AND SELF-ASSESSMENT\*

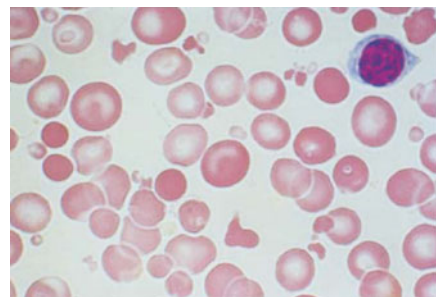
Charles Wiener ■ Gerald Bloomfield ■ Cynthia D. Brown  
■ Joshua Schiffer ■ Adam Spivak

## QUESTIONS

**DIRECTIONS:** Choose the **one best** response to each question.

1. A 73-year-old man presents to the clinic with 3 months of increasing back pain. He localizes the pain to the lumbar spine and states that the pain is worst at night while he is lying in bed. It is improved during the day with mobilization. Past history is notable only for hypertension and remote cigarette smoking. Physical examination is normal. Laboratory studies are notable for an elevated alkaline phosphatase. A lumbar radiogram shows a lytic lesion in the L3 vertebra. Which of the following malignancies is most likely?
  - A. Gastric carcinoma
  - B. Non-small cell lung cancer
  - C. Osteosarcoma
  - D. Pancreatic carcinoma
  - E. Thyroid carcinoma
2. Patients from which of the following regions need not be screened for glucose-6-phosphate dehydrogenase (G6PD) deficiency when starting a drug that carries a risk for G6PD-mediated hemolysis?
  - A. Brazil
  - B. Russia
  - C. Southeast Asia
  - D. Southern Europe
  - E. Sub-Saharan Africa
  - F. None of the above
3. All the following are vitamin K-dependent coagulation factors *except*
  - A. factor X
  - B. factor VII
  - C. protein C
  - D. protein S
  - E. factor VIII
4. A 31-year-old man with hemophilia A is admitted with persistent gross hematuria. He denies recent

4. (*Continued*)  
trauma or any history of genitourinary pathology. The examination is unremarkable. Hematocrit is 28%. All the following are treatments for hemophilia A *except*
  - A. desmopressin (DDAVP)
  - B. fresh-frozen plasma (FFP)
  - C. cryoprecipitate
  - D. recombinant factor VIII
  - E. plasmapheresis
5. Which of the following statements regarding incidence of and risk factors for hepatocellular carcinoma is true?
  - A. A chemical toxin produced by *Aspergillus* species, aflatoxin B has a strong association with development of hepatocellular carcinoma and can be found in stored grains in hot, humid places.
  - B. In the United States, the incidence of hepatocellular carcinoma is decreasing.
  - C. Nonalcoholic steatohepatitis is not associated with an increased risk for hepatocellular carcinoma.
  - D. Fewer than 5% of individuals diagnosed with hepatocellular carcinoma in the United States do not have underlying cirrhosis.
  - E. The risk of developing hepatocellular carcinoma in individuals with hepatitis C infection is 50%.
6. You are asked to review the peripheral blood smear from a patient with anemia. Serum lactate dehydrogenase is elevated and there is hemoglobinuria. This patient is likely to have which physical examination finding? (See Figure 6 below)



\*Questions and answers were taken from Wiener C, et al (eds). *Harrison's Principles of Internal Medicine Self-Assessment and Board Review*, 17th ed. New York: McGraw-Hill, 2008.

6. (Continued)

- A. Goiter
- B. Heme-positive stools
- C. Mechanical second heart sound
- D. Splenomegaly
- E. Thickened calvarium

7. A 55-year-old woman presents with progressive incoordination. Physical examination is remarkable for nystagmus, mild dysarthria, and past pointing on finger-to-nose testing. She also has an unsteady gait. MRI reveals atrophy of both lobes of the cerebellum. Serologic evaluation reveals the presence of anti-Yo antibody. Which of the following is the most likely cause of this clinical syndrome?

- A. Non-small cell cancer of the lung
- B. Small-cell cancer of the lung
- C. Breast cancer
- D. Non-Hodgkin's lymphoma
- E. Colon cancer

8. A 36-year-old African-American woman with systemic lupus erythematosus presents with the acute onset of lethargy and jaundice. On initial evaluation, she is tachycardic, hypotensive, appears pale, is dyspneic, and is somewhat difficult to arouse. Physical examination reveals splenomegaly. Her initial hemoglobin is 6 g/dL, white blood cell count is 6300/ $\mu$ L, and platelets are 294,000/ $\mu$ L. Her total bilirubin is 4 g/dL, reticulocyte count is 18%, and haptoglobin is not detectable. Renal function is normal, as is urinalysis. What would you expect on her peripheral blood smear?

- A. Macrocytosis and PMNs with hypersegmented nuclei
- B. Microspherocytes
- C. Schistocytes
- D. Sickle cells
- E. Target cells

9. You are investigating the cause for a patient's anemia. He is a 50-year-old man who was found to have a hematocrit of 25% on routine evaluation. His hematocrit was 47% 1 year ago. Mean corpuscular volume is 80, mean corpuscular hemoglobin concentration is 25, and mean corpuscular hemoglobin is 25. Reticulocyte count is 5%. Review of the peripheral blood smear shows marked numbers of polychromatophilic macrocytes. Ferritin is 340  $\mu$ g/L. What is the cause of this patient's anemia?

- A. Defective erythroid marrow proliferation
- B. Extravascular hemolysis

9. (Continued)

- C. Intravascular hemolysis
- D. Iron-deficiency anemia
- E. Occult gastrointestinal bleeding

10. All the following are associated with pure red cell aplasia *except*

- A. anterior mediastinal masses
- B. connective tissue disorders
- C. giant pronormoblasts
- D. low erythropoietin levels
- E. parvovirus B19 infection

11. A 73-year-old man is admitted to the hospital with 3 weeks of malaise and fevers. His past medical history is notable only for hypertension controlled with a thiazide diuretic. He smokes one pack of cigarettes per day and works as an attorney. His physical examination is notable only for a new systolic heart murmur heard best in the mitral region. His laboratory examination is notable for mild anemia, an elevated white blood cell count, and occasional red blood cells on clean catch urine. Blood cultures grow *Streptococcus bovis* and echocardiogram shows a <1-cm vegetation on the mitral valve. What additional evaluation is indicated for this patient?

- A. Colonoscopy
- B. Head CT scan
- C. Pulmonary embolism protocol CT scan
- D. Renal biopsy
- E. Toxicology screen

12. A 58-year-old woman presents to the emergency department complaining of jaundice. She first noticed a yellowish discoloration of her skin ~3 days ago. It has become progressively worse since that time. In association with the development of jaundice, she also has noticed clay-colored stools and pruritus. There has been no associated abdominal pain, fever, chills, or night sweats. She has a past medical history of alcohol abuse but has been abstinent for the past 10 years. She has no known history of cirrhosis. On physical examination, she is afebrile with normal vital signs. She is jaundiced. The bowel sounds are normal. The abdomen is soft and nontender. There is no distention. The liver span is 12 cm to percussion and is palpable at the right costal margin. The spleen tip is not palpable. Liver function testing reveals an AST of 122 IU/L, ALT of 168 IU/L, alkaline phosphatase of 483 U/L, total bilirubin of 22.1 mg/dL, and direct bilirubin of 19.2 mg/dL. On right upper quadrant ultrasound,

12. (Continued)  
the gallbladder cannot be visualized, and there is dilatation of the intrahepatic bile ducts but not the common bile duct. What is the most likely diagnosis?
- A. Cholangiocarcinoma
  - B. Cholecystitis
  - C. Gallbladder cancer
  - D. Hepatocellular carcinoma
  - E. Pancreatic cancer
13. An 81-year-old man is admitted to the hospital for altered mental status. He was found at home, confused and lethargic, by his son. His past medical history is significant for metastatic prostate cancer. The patient's medications include periodic intramuscular goserelin injections. On examination he is afebrile. Blood pressure is 110/50 mm Hg, and the pulse rate is 110 beats/min. He is lethargic and minimally responsive to sternal rub. He has bitemporal wasting, and his mucous membranes are dry. On neurologic examination he is obtunded. The patient has an intact gag reflex and withdraws to pain in all four extremities. Rectal tone is normal. Laboratory values are significant for a creatinine of 4.2 mg/dL, a calcium level of 12.4 meq/L, and an albumin of 2.6 g/dL. All the following are appropriate initial management steps except
- A. normal saline
  - B. pamidronate
  - C. furosemide when the patient is euvolemic
  - D. calcitonin
  - E. dexamethasone
14. Which of the following statements describes the relationship between testicular tumors and serum markers?
- A. Pure seminomas produce  $\alpha$  fetoprotein (AFP) or  $\beta$  human chorionic gonadotropin ( $\beta$ -hCG) in >90% of cases.
  - B. More than 40% of nonseminomatous germ cell tumors produce no cell markers.
  - C. Both  $\beta$ -hCG and AFP should be measured in following the progress of a tumor.
  - D. Measurement of tumor markers the day after surgery for localized disease is useful in determining completeness of the resection.
  - E.  $\beta$ -hCG is limited in its usefulness as a marker because it is identical to human luteinizing hormone.
15. A woman with advanced breast cancer being treated with tamoxifen presents to the emergency department with nausea and vomiting. She has been tolerating her treatment well but in the last 3 days noticed nausea, vomiting, and abdominal pain. Her symptoms are not related to food intake, and she is having normal bowel movements. She has no fevers or rashes. Her medications include tamoxifen, alendronate, megestrol acetate, and a multivitamin. Abdominal examination reveals very mild tenderness diffusely, and there is no rebound tenderness. Bowel sounds are normal. Plain radiographs and a CT scan of the abdomen are unremarkable. Laboratory analysis reveals a normal white blood cell count. Sodium is 130 meq/L, potassium 4.9 meq/L, chloride 99 meq/L, bicarbonate 29 meq/L, BUN 15 mg/dL, creatinine 0.7 mg/dL. What is the next most appropriate step in this patient's management?
- A. Antiemetics prn
  - B. Laparoscopy
  - C. Serum cortisol
  - D. Small-bowel follow-through
  - E. Upper endoscopy
15. (Continued)  
department with nausea and vomiting. She has been tolerating her treatment well but in the last 3 days noticed nausea, vomiting, and abdominal pain. Her symptoms are not related to food intake, and she is having normal bowel movements. She has no fevers or rashes. Her medications include tamoxifen, alendronate, megestrol acetate, and a multivitamin. Abdominal examination reveals very mild tenderness diffusely, and there is no rebound tenderness. Bowel sounds are normal. Plain radiographs and a CT scan of the abdomen are unremarkable. Laboratory analysis reveals a normal white blood cell count. Sodium is 130 meq/L, potassium 4.9 meq/L, chloride 99 meq/L, bicarbonate 29 meq/L, BUN 15 mg/dL, creatinine 0.7 mg/dL. What is the next most appropriate step in this patient's management?
- A. Colonoscopy in 3 months
  - B. Colonoscopy in 3 years
  - C. Colonoscopy in 10 years
  - D. CT scan of the abdomen
  - E. Partial colectomy
  - F. Reassurance
16. A healthy 62-year-old woman returns to your clinic after undergoing routine colonoscopy. Findings included two 1.3-cm sessile (flat-based) villous adenomas in her ascending colon that were removed during the procedure. What is the next step in management?
- A. Colonoscopy in 3 months
  - B. Colonoscopy in 3 years
  - C. Colonoscopy in 10 years
  - D. CT scan of the abdomen
  - E. Partial colectomy
  - F. Reassurance
17. Which of the following statements regarding polycythemia vera is correct?
- A. An elevated plasma erythropoietin level excludes the diagnosis.
  - B. Transformation to acute leukemia is common.
  - C. Thrombocytosis correlates strongly with thrombotic risk.
  - D. Aspirin should be prescribed to all these patients to reduce thrombotic risk.
  - E. Phlebotomy is used only after hydroxyurea and interferon have been tried.
18. A 52-year-old woman is evaluated for abdominal swelling with a computed tomogram that shows ascites and likely peritoneal studding of tumor but no



18. (Continued)

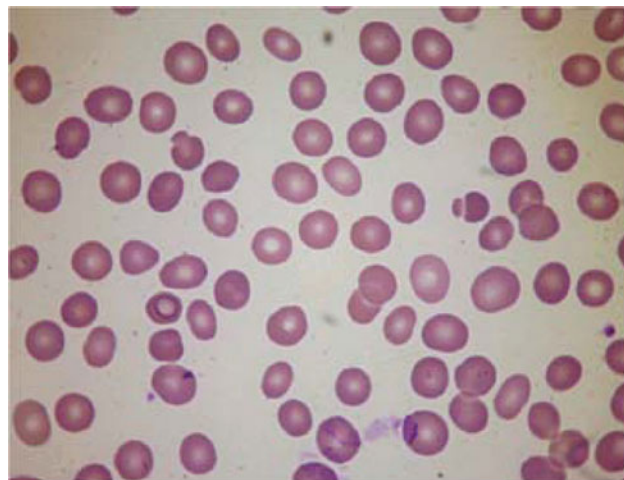
other abnormality. Paracentesis shows adenocarcinoma but cannot be further differentiated by the pathologist. A thorough physical examination, including breast and pelvic examination, shows no abnormality. CA-125 levels are elevated. Pelvic ultrasound and mammography are normal. Which of the following statements is true?

- A. Compared with other women with known ovarian cancer at a similar stage, this patient can be expected to have a less than average survival.
  - B. Debulking surgery is indicated.
  - C. Surgical debulking plus cisplatin and paclitaxel is indicated.
  - D. Bilateral mastectomy and bilateral oophorectomy will improve survival.
  - E. Fewer than 1% of patients with this disorder will remain disease-free 2 years after treatment.
19. A 34-year-old woman with a past medical history of sickle cell anemia presents with a 5-day history of fatigue, lethargy, and shortness of breath. She denies chest pain or bone pain. She has had no recent travel. Of note, the patient's 4-year-old daughter had a "cold" 2 weeks before the presentation. On examination she has pale conjunctiva, is anicteric, and is mildly tachycardic. Abdominal examination is unremarkable. Laboratories show a hemoglobin of 3 g/dL; her baseline is 8 g/dL. The white blood cell count and platelets are normal. Reticulocyte count is undetectable. Total bilirubin is 1.4 mg/dL. Lactic dehydrogenase is at the upper limits of the normal range. Peripheral blood smear shows a few sickled cells but a total absence of reticulocytes. The patient is given a transfusion of 2 units of packed red blood cells and admitted to the hospital. A bone marrow biopsy shows a normal myeloid series but an absence of erythroid precursors. Cytogenetics is normal. What is the most appropriate next management step?

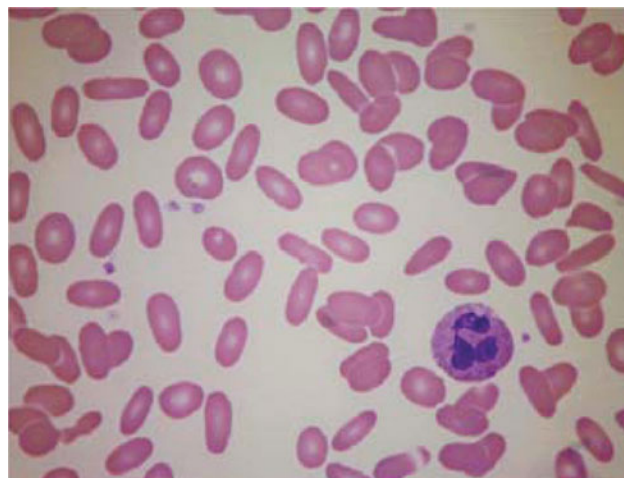
- A. Make arrangements for exchange transfusion.
  - B. Tissue-type her siblings for a possible bone marrow transplant.
  - C. Check parvovirus titers.
  - D. Start prednisone and cyclosporine.
  - E. Start broad-spectrum antibiotics.
20. A 22-year-old pregnant woman of northern European descent presents 3 months into her first pregnancy with extreme fatigue, pallor, and icterus. She reports being previously healthy. On evaluation her hemoglobin is 8 g/dL, reticulocyte count is 9%,

20. (Continued)

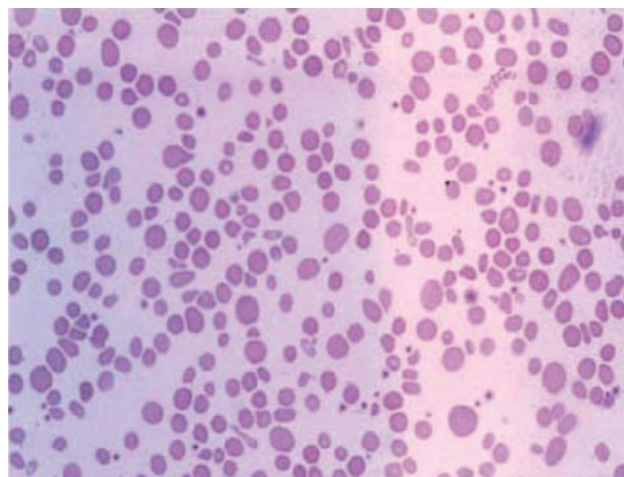
indirect bilirubin is 4.9 mg/dL, and serum haptoglobin is not detectable. Her physical examination is notable for splenomegaly and a normal 3-month uterus. Peripheral smear is shown below. What is the most likely diagnosis? (See Figure 20 below)



A



B



C

20. (Continued)
- A. Colonic polyp
  - B. G6PD deficiency
  - C. Hereditary spherocytosis
  - D. Parvovirus B19 infection
  - E. Thrombotic thrombocytopenic purpura
21. A patient with acute lymphoid leukemia (ALL) is admitted with respiratory distress and chest pain. The patient reports 1 day of shortness of breath not associated with cough. There have been no sick contacts, and before the onset of the respiratory symptoms, the patient only recalls fatigue. A chest radiograph shows faint diffuse interstitial infiltrates without pulmonary edema. The cardiac silhouette is normal. An arterial blood gas shows a  $\text{PaO}_2 = 54$  mm Hg, while the pulse oximetry is 97% on room air. A carbon monoxide level is normal. All of the following laboratory abnormalities are expected in this patient *except*
- A. bcr-abl mutation
  - B. blast count  $>100,000/\mu\text{L}$
  - C. elevated lactate dehydrogenase levels
  - D. increased blood viscosity
  - E. methemoglobinemia
22. A 48-year-old man is referred for evaluation by an acute care center because of a nodule on chest radiography. Three weeks ago he was diagnosed with pneumonia after reporting 3 days of fever, cough, and sputum production. The chest radiogram showed a small right lower lobe alveolar infiltrate and a left upper lobe 1.5-cm round nodule. He was treated with antibiotics and is now asymptomatic. A repeat chest radiogram shows that the right lower lobe pneumonia is resolved, but the nodule is still present. He is asymptomatic. He smoked one pack of cigarettes per day for 25 years and quit 3 years ago. He never had a prior chest radiogram. CT scan shows that the nodule is 1.5 by 1.7 cm and is located centrally in the left upper lobe, has no calcification, and has slightly scalloped edges. There is no mediastinal adenopathy or pleural effusion. Which of the following is the appropriate next step in his management?
- A. Bronchoscopy
  - B. Mediastinoscopy
  - C. MRI scan
  - D.  $^{18}\text{F}$ FDG PET scan
  - E. Repeat chest CT in 6 months
23. All the following types of cancer commonly metastasize to the central nervous system (CNS) *except*
- A. ovarian
  - B. breast
  - C. hypernephroma
  - D. melanoma
  - E. acute lymphoblastic leukemia (ALL)
24. A 54-year-old woman with atrial fibrillation is anticoagulated with warfarin, 5 mg daily. She developed a urinary tract infection that her primary care physician has treated with ciprofloxacin, 250 mg orally twice daily for 7 days. She presents to the emergency department today complaining of blood in her urine and easy bruising. Her physical examination shows ecchymoses on her arms. Her urine is bloody in appearance, but no clots are present. After flushing the bladder with 100 mL of sterile saline, the urine returns with a slight pink hue only. A urinalysis shows 3–5 white blood cells per high power field and many red blood cells per high power field. There are no bacteria present. The international normalized ratio (INR) is 7.0. What is the best approach to treatment of this patient's coagulopathy?
- A. Administer vitamin K 10 mg IV.
  - B. Administer vitamin K 2 mg SC.
  - C. Administer vitamin K 1 mg sublingually.
  - D. Hold further warfarin doses until the INR falls to 2.0.
  - E. Transfuse four units of fresh-frozen plasma.
25. Which of the following statements about cardiac toxicity from cancer treatment is true?
- A. Doxorubicin-based cardiac toxicity is idiosyncratic and dose-independent.
  - B. Anthracycline-induced congestive heart failure is reversible with time and control of risk factors.
  - C. Mediastinal irradiation often results in acute pericarditis during the first few weeks of treatment.
  - D. Chronic constrictive pericarditis often manifests symptomatically up to 10 years after treatment.
  - E. The incidence of coronary atherosclerosis in patients who have a history of mediastinal irradiation is the same as that in age-matched controls.
26. A 23-year-old woman is diagnosed with a lower extremity deep vein thrombosis. Which of the following medical conditions represents a contraindication to therapy with low-molecular-weight heparin (LMWH)?
- A. Pregnancy
  - B. Obesity
  - C. Dialysis-dependent renal failure
  - D. Uncontrolled diabetes mellitus
  - E. Jaundice

27. Which of the following pairs of chemotherapy and complication is incorrect?
- Daunorubicin—CHF
  - Bleomycin—interstitial fibrosis
  - Cyclophosphamide—hematuria
  - Cisplatin—liver failure
  - Ifosfamide—Fanconi's syndrome
28. A 70-year-old man is admitted to the cardiac care unit for complaints of chest pressure occurring at rest radiating to his left arm with associated diaphoresis and presyncope. His admission electrocardiogram (ECG) showed ST depressions in V4–V6. The chest pain and ECG changes resolve with sublingual nitroglycerin. He is treated with IV heparin, aspirin, metoprolol, and lisinopril. His cardiac catheterization shows 90% occlusion of the left anterior descending artery, 80% occlusion of the distal circumflex artery, and 99% occlusion of the right coronary artery. He remains in the cardiac care unit awaiting coronary artery bypass. He has a history of rheumatic heart disease and underwent mechanical mitral valve replacement at age 58. On admission, his hemoglobin is 12.2 g/dL, hematocrit 37.1%, white blood cell (WBC) count 9800/ $\mu$ L, and platelet count 240,000/ $\mu$ L. His creatinine is 1.7 mg/dL. On the fourth hospital day, his hemoglobin is 10.0, hematocrit 31%, WBC count 7600/ $\mu$ L, and platelet count 112,000/ $\mu$ L. His creatinine has risen to 2.9 mg/dL after the cardiac catheterization. What is the most appropriate treatment of the patient at this time?
- Continue heparin and give a platelet transfusion.
  - Discontinue heparin infusion and start argatroban.
  - Discontinue heparin and start lepirudin.
  - Discontinue heparin and start warfarin.
  - Send serum to assess for the presence of heparin–platelet factor 4 (PF4) IgG antibody and continue heparin.
29. A 24-year-old woman presents to the emergency department complaining of a red tender rash that has been spreading across her arms and legs over the past 2 days. She also describes severe diffuse muscle pain that has worsened over a week's time. She woke up feeling as though she could not catch her breath and has developed a dry cough over the past several days. She is without any significant medical history but recalls that she had similar symptoms several years ago, and was told she was having an allergic reaction. Her symptoms abated with an oral glucocorticoid taper. She takes no prescription medications but takes a number of over-the-counter nutritional supplements daily. She cannot
29. (Continued)
- describe any allergic trigger to her previous episode or her current one. Her family history is unremarkable, and her close contacts are not ill. She works in an office, has no pets, and has not traveled internationally. Her laboratory results are remarkable for a leukocyte count of 12,100 cells/ $\mu$ L and a total eosinophil count of 1100/ $\mu$ L. Which of the following is the most likely cause of her symptoms?
- Early stage of systemic lupus erythematosus
  - Gluten allergy
  - Ingestion of L-tryptophan
  - Lactose intolerance
  - Recent viral upper respiratory tract infection
30. A woman wants your advice regarding Papanicolaou smears. She is 36 years old and is monogamous with her husband since they were married 3 years ago. She has had normal Pap smears every year for the past 6 years. She would like to avoid the yearly test. What is your advice to this patient, based on the current screening guidelines?
- She may discontinue screening at age 50 if she has had normal yearly Pap smears for the previous 10 years.
  - She may extend the screening interval to once every 2–3 years.
  - She may extend the screening interval to once every 5 years if she agrees to use barrier protection.
  - She may discontinue Pap screening if she receives the human papilloma virus (HPV) vaccine.
  - The only indication to cease Pap testing is if she were to have a total hysterectomy.
31. The evaluation in a newly diagnosed case of acute lymphoid leukemia (ALL) should routinely include all of the following *except*
- bone marrow biopsy
  - cell-surface phenotyping
  - complete metabolic panel
  - cytogenetic testing
  - lumbar puncture
  - plasma viscosity
32. Which of the following statements about lead-time bias occurrence is true?
- A test does not influence the natural history of the disease; patients are merely diagnosed at an earlier date.
  - Slow-growing, less aggressive cancers are detected during screening; aggressive cancers are not detected by screening, due to death.

32. (Continued)

- C. Screening identifies abnormalities that would never have caused a problem during a person's lifetime.
- D. The screened population differs significantly from the general population in that they are healthier.
- E. A test detects disease at an earlier and more curable stage of disease.

33. All but which of the following statements about the lupus anticoagulant (LA) are true?

- A. Lupus anticoagulants typically prolong the aPTT.
- B. A 1:1 mixing study will not correct in the presence of lupus anticoagulants.
- C. Bleeding episodes in patients with lupus anticoagulants may be severe and life-threatening.
- D. Female patients may experience recurrent midtrimester abortions.
- E. Lupus anticoagulants may occur in the absence of other signs of systemic lupus erythematosus (SLE).

34. The most common inherited prothrombotic disorder is

- A. activated protein C resistance
- B. prothrombin gene mutation
- C. protein C deficiency
- D. protein S deficiency
- E. antithrombin deficiency

35. A 34-year-old woman presents for evaluation of left lower extremity swelling and pain. She is obese and 8 weeks postpartum. She recently traveled 6 h by airplane to visit her parents with her infant. She has had no dyspnea, palpitations, or syncope. She is currently on no medications except iron tablets. She is otherwise healthy. Her vital signs are: heart rate 86 beats/min, blood pressure 110/80 mm Hg, temperature 37.0°C, and respiratory rate 12 breaths/min. Her weight is 98 kg, and height is 170 cm. The left lower extremity is swollen, tender, and warm to touch. A Homan's sign is present, but there are no palpable cords. A lower extremity Doppler shows a thrombosis in the common and superficial femoral veins of the left leg. You are considering outpatient treatment with enoxaparin. All of the following statements regarding low-molecular-weight heparins (LMWH) are true *except*

- A. In patients with uncomplicated deep vein thrombosis (DVT), LMWH is a safe and effective alternative to IV heparin and is associated with reduced health care costs compared to IV heparin.
- B. LMWH can be safely used in pregnancy, but factor Xa levels should be monitored to ensure adequate anticoagulation.

35. (Continued)

- C. Monitoring of factor Xa levels is unnecessary in most patients because there is a predictable dose-dependent anticoagulation effect.
- D. There is a decrease in the risk of development of heparin-induced thrombocytopenia with use of LMWH.
- E. This patient's recent pregnancy is a contraindication to use of LMWH because there is a greater risk of bleeding with LMWH compared to IV heparin.

36. A 65-year-old man is brought to the emergency department by ambulance after his daughter found him to be incoherent earlier today. She last spoke with him yesterday, and at that time, he was complaining of 2 days of myalgias, headache, and fever. He had attributed it to an upper respiratory tract infection and did not seek evaluation from his primary care physician. Today, he did not answer when she called his home, and she found him lying in his bed smelling of urine. He was minimally arousable but appeared to be moving all of his extremities. His past medical history is significant for hypertension, hypercholesterolemia, and chronic obstructive pulmonary disease. He was evaluated 2 weeks previously for a transient ischemic attack after an episode where he had numbness and weakness of his left arm and leg that resolved over 6 h without intervention. His current medications include aspirin, 81 mg daily, clopidogrel, 75 mg daily, atenolol, 100 mg daily, atorvastatin, 20 mg daily, and tiotropium, once daily. He is allergic to lisinopril, which caused angioedema. He is a former smoker and drinks alcohol rarely.

On physical examination, he is obtunded and minimally arousable. He is febrile with a temperature of 38.9°C. His blood pressure is 159/96 mm Hg, and heart rate is 98 beats/min. He is breathing at a rate of 24 breaths/min with a room air oxygen saturation of 95%. He has minimal scleral icterus. The oropharynx reveals dry mucous membranes. His cardiovascular, pulmonary, and abdominal examinations are normal. There are no rashes. His neurologic examination is difficult to obtain. There are no cranial nerve findings. He resists movement of his extremities but has normal strength. Deep tendon reflexes are brisk, 3+, and equal.

The laboratory values are as follows: hemoglobin 9.3 g/dL, hematocrit 29.1%, white blood cell count 14,000/ $\mu$ L, and platelets 42,000/ $\mu$ L. The differential demonstrates 83% neutrophils, 2% band forms, 6% lymphocytes, and 9% monocytes. The sodium is 145 meq/L, potassium 3.8 meq/L, chloride 113 meq/L, bicarbonate 19 meq/L, blood urea

36. (Continued)  
nitrogen 68 mg/dL, and creatinine 3.4 mg/dL. The bilirubin is 2.4 mg/dL, and lactate dehydrogenase is 450 U/L. A peripheral blood smear shows diminished platelets and many schistocytes. What is the next most appropriate step in this patient's care?
- Discontinue clopidogrel.
  - Discontinue clopidogrel and initiate plasmapheresis.
  - Initiate therapy with intravenous immunoglobulin.
  - Obtain a head CT scan and initiate treatment with factor VIIa, if subarachnoid hemorrhage is seen.
  - Perform a lumbar puncture and start broad-spectrum antibiotic coverage with ceftazidime and vancomycin.
37. A primary tumor of which of these organs is the *least likely* to metastasize to bone?
- Breast
  - Colon
  - Kidney
  - Lung
  - Prostate
38. The triad of portal vein thrombosis, hemolysis, and pancytopenia suggests which of the following diagnoses?
- Acute promyelocytic leukemia
  - Hemolytic-uremic syndrome (HUS)
  - Leptospirosis
  - Paroxysmal nocturnal hemoglobinuria (PNH)
  - Thrombotic thrombocytopenia purpura (TTP)
39. A 68-year-old man seeks evaluation for fatigue, weight loss, and early satiety that have been present for ~4 months. On physical examination, his spleen is noted to be markedly enlarged. It is firm to touch and crosses the midline. The lower edge of the spleen reaches to the pelvis. His hemoglobin is 11.1 g/dL, and hematocrit is 33.7%. The leukocyte count is 6200/ $\mu$ L, and platelet count is 220,000/ $\mu$ L. The white cell count differential is 75% PMNs, 8% myelocytes, 4% metamyelocytes, 8% lymphocytes, 3% monocytes, and 2% eosinophils. The peripheral blood smear shows teardrop cells, nucleated red blood cells, and immature granulocytes. Rheumatoid factor is positive. A bone marrow biopsy is attempted, but no cells are able to be aspirated. No evidence of leukemia or lymphoma is found. What is the most likely cause of the splenomegaly?
- Chronic idiopathic myelofibrosis
  - Chronic myelogenous leukemia
39. (Continued)  
C. Rheumatoid arthritis  
D. Systemic lupus erythematosus  
E. Tuberculosis
40. The most common cause of high serum calcium in a patient with a known cancer is
- ectopic production of parathyroid hormone
  - direct destruction of bone by tumor cells
  - local production of tumor necrosis factor and IL-6 by bony metastasis
  - high levels of 1,25-hydroxyvitamin D
  - production of parathyroid hormone-like substance
41. A 72-year-old man with chronic obstructive pulmonary disease and stable coronary disease presents to the emergency department with several days of worsening productive cough, fevers, malaise, and diffuse muscle aches. A chest x-ray demonstrates a new lobar infiltrate. Laboratory measurements reveal a total white blood cell count of 12,100 cells/ $\mu$ L, with a neutrophilic predominance of 86% and 8% band forms. He is diagnosed with community-acquired pneumonia, and antibiotic treatment is initiated. Under normal, or "nonstress," conditions, what percentage of the total body neutrophils are present in the circulation?
- 2%
  - 10%
  - 25%
  - 40%
  - 90%
42. All of the following laboratory values are consistent with an intravascular hemolytic anemia *except*
- increased haptoglobin
  - increased lactate dehydrogenase (LDH)
  - increased reticulocyte count
  - increased unconjugated bilirubin
  - increased urine hemosiderin
43. All the following match the anticoagulant with its correct mechanism of action *except*
- abciximab—GpIIb/IIIa receptor inhibition
  - clopidogrel—inhibition of thromboxane A<sub>2</sub> release
  - fondaparinux—inhibition of factor Xa
  - argatroban—thrombin inhibition
  - warfarin—vitamin K-dependent carboxylation of coagulation factors

44. All the following are late complications of bone marrow transplant preparative regimens *except*
- A. growth retardation
  - B. azoospermia
  - C. hypothyroidism
  - D. cataracts
  - E. dementia
45. Which of the following best describes the mechanism of action of clopidogrel?
- A. Activates antithrombin and inhibits clotting enzymes
  - B. Binds to the activated GPIIb/IIIa receptor on the platelet surface to block binding of adhesive molecules
  - C. Inhibits cyclooxygenase 1 (COX-1) on platelets to decrease production of thromboxane A<sub>2</sub>
  - D. Inhibits phosphodiesterase to block the breakdown of cyclic adenosine monophosphate (cAMP) to inhibit platelet activation
  - E. Irreversibly blocks P2Y<sub>12</sub> to prevent adenosine diphosphate (ADP)-induced platelet aggregation
46. A 45-year-old man is evaluated by his primary care physician for complaints of early satiety and weight loss. On physical examination, his spleen is palpable 10 cm below the left costal margin and is mildly tender to palpation. His laboratory studies show a leukocyte count of 125,000/ $\mu$ L with a differential of 80% neutrophils, 9% bands, 3% myelocytes, 3% metamyelocytes, 1% blasts, 1% lymphocytes, 1% eosinophils, and 1% basophils. Hemoglobin is 8.4 g/dL, hematocrit 26.8%, and platelet count 668,000/ $\mu$ L. A bone marrow biopsy demonstrates increased cellularity with an increased myeloid-to-erythroid ratio. Which of the following cytogenetic abnormalities is most likely to be found in this patient?
- A. Deletion of a portion of the long arm of chromosome 5, del(5q)
  - B. Inversion of chromosome 16, inv(16)
  - C. Reciprocal translocation between chromosomes 9 and 22 (Philadelphia chromosome)
  - D. Translocations of the long arms of chromosomes 15 and 17
  - E. Trisomy 12
47. A 32-year-old man presents complaining of a testicular mass. On examination you palpate a 1-by 2-cm painless mass on the surface of the left testicle. A chest x-ray shows no lesions, and a CT scan of the abdomen and pelvis shows no evidence of retroperitoneal adenopathy. The  $\alpha$  fetoprotein (AFP) level is elevated at 400 ng/mL. Beta human chorionic gonadotropin ( $\beta$ -hCG) is normal, as is
- LDH. You send the patient for an orchiectomy. The pathology comes back as seminoma limited to the testis alone. The AFP level declines to normal at an appropriate interval. What is the appropriate management at this point?
- A. Radiation to the retroperitoneal lymph nodes
  - B. Adjuvant chemotherapy
  - C. Hormonal therapy
  - D. Retroperitoneal lymph node dissection (RPLND)
  - E. Positron emission tomography (PET) scan
47. (*Continued*)
48. All of the following statements regarding tobacco usage and cessation are correct *except*
- A. Most Americans who quit do so on their own without involvement in an organized cessation program.
  - B. Over 80% of adult Americans who smoke began before the age of 18.
  - C. Smokeless tobacco is associated with gum and dental disease, not cancer.
  - D. Tobacco cessation messages and programs are more effective for light smokers than for heavy smokers.
  - E. Tobacco use is the most modifiable cancer risk factor.
49. A 29-year-old man is found on routine chest radiography for life insurance to have right hilar adenopathy. He is otherwise healthy. Besides biopsy of the lymph nodes, which of the following is indicated?
- A. Angiotensin-converting enzyme (ACE) level
  - B.  $\beta$ -hCG
  - C. Thyroid-stimulating hormone (TSH)
  - D. PSA
  - E. C-reactive protein
50. Which of the following is correct regarding small-cell lung cancer compared with non-small cell lung cancer?
- A. Small cell lung cancer is more radiosensitive.
  - B. Small cell lung cancer is less chemosensitive.
  - C. Small cell lung cancer is more likely to present peripherally in the lung.
  - D. Small cell lung cancer is derived from an alveolar cell.
  - E. Bone marrow involvement is more common in non-small cell lung cancer.
51. Which of the following statements regarding esophageal cancer is true?
- A. Cigarette smoking and heavy alcohol intake are synergistic risk factors for adenocarcinoma.
  - B. Chronic gastric reflux is a risk factor for development of esophageal squamous cell carcinoma.

51. (*Continued*)
- C. Esophageal cancer is most common in the middle third of the esophagus.
  - D. Incidence of squamous cell carcinoma has decreased over the past 30 years while adenocarcinoma continues to increase.
  - E. The prognosis for patients with adenocarcinoma is consistently better than for those with squamous cell carcinoma.
  - F. All of the above are true.
52. All the following conditions are associated with an increased incidence of cancer *except*
- A. Down's syndrome
  - B. Fanconi's anemia
  - C. Von Hippel-Lindau syndrome
  - D. neurofibromatosis
  - E. fragile X syndrome
53. A 50-year-old woman presents to your clinic for evaluation of an elevated platelet count. The latest complete blood count is white blood cells (WBC)  $7,000/\text{mm}^3$ , hematocrit 34%, and platelets  $600,000/\text{mm}^3$ . All the following are common causes of thrombocytosis *except*
- A. iron-deficiency anemia
  - B. essential thrombocytosis
  - C. chronic myeloid leukemia
  - D. myelodysplasia
  - E. pernicious anemia
54. A 76-year-old man presents to an urgent care clinic with pain in his left leg for 4 days. He also describes swelling in his left ankle, which has made it difficult for him to ambulate. He is an active smoker and has a medical history remarkable for gastroesophageal reflux disease, prior deep vein thrombosis (DVT) 9 months ago that resolved, and well-controlled hypertension. Physical examination is revealing for 2+ edema in his left ankle. A D-dimer is ordered and is elevated. Which of the following makes D-dimer less predictive of DVT in this patient?
- A. Age >70 years
  - B. History of active tobacco use
  - C. Lack of suggestive clinical symptoms
  - D. Negative Homan's sign on examination
  - E. Previous DVT in the past year
55. A patient with longstanding HIV infection, alcoholism, and asthma is seen in the emergency department for 1–2 days of severe wheezing. He has not been taking any medicines for months. He is admitted to the hospital and treated with nebulized therapy and systemic glucocorticoids. His CD4 count is 8 and viral load is  $>750,000$ . His total white blood cell (WBC) count is  $3200 \text{ cells}/\mu\text{L}$  with 90% neutrophils. He is accepted into an inpatient substance abuse rehabilitation program and before discharge is started on opportunistic infection prophylaxis, bronchodilators, a prednisone taper over 2 weeks, ranitidine, and highly active antiretroviral therapy. The rehabilitation center pages you 2 weeks later; a routine laboratory check reveals a total WBC count of  $900 \text{ cells}/\mu\text{L}$  with 5% neutrophils. Which of the following new drugs would most likely explain this patient's neutropenia?
- A. Darunavir
  - B. Efavirenz
  - C. Ranitidine
  - D. Prednisone
  - E. Trimethoprim-sulfamethoxazole
55. (*Continued*)
- has not been taking any medicines for months. He is admitted to the hospital and treated with nebulized therapy and systemic glucocorticoids. His CD4 count is 8 and viral load is  $>750,000$ . His total white blood cell (WBC) count is  $3200 \text{ cells}/\mu\text{L}$  with 90% neutrophils. He is accepted into an inpatient substance abuse rehabilitation program and before discharge is started on opportunistic infection prophylaxis, bronchodilators, a prednisone taper over 2 weeks, ranitidine, and highly active antiretroviral therapy. The rehabilitation center pages you 2 weeks later; a routine laboratory check reveals a total WBC count of  $900 \text{ cells}/\mu\text{L}$  with 5% neutrophils. Which of the following new drugs would most likely explain this patient's neutropenia?
- A. Darunavir
  - B. Efavirenz
  - C. Ranitidine
  - D. Prednisone
  - E. Trimethoprim-sulfamethoxazole
56. Which of the following symptoms is most suggestive of an esophageal mass?
- A. Early satiety
  - B. Liquid phase dysphagia only
  - C. Odynophagia with chest pain
  - D. Oropharyngeal dysphagia
  - E. Solid phase dysphagia progressing to liquid phase dysphagia
57. All of the following have been associated with development of a lymphoid malignancy *except*
- A. celiac sprue
  - B. *Helicobacter pylori* infection
  - C. hepatitis B infection
  - D. HIV infection
  - E. human herpes virus 8 (HHV8) infection
  - F. inherited immunodeficiency syndromes
58. A 31-year-old woman is referred to your clinic for an evaluation of anemia. She describes a 2-month history of fatigue. She denies abdominal pain but notes that her abdomen has become slightly more distended in recent weeks. Past medical history is otherwise unremarkable. The patient's parents are alive, and she has three healthy siblings. Physical examination is significant for pale conjunctiva and a palpable spleen 4 cm below the left costal margin. Hematocrit is 31% and bilirubin is normal. The reticulocyte percentage is low. Haptoglobin and lactic dehydrogenase (LDH) are normal. A peripheral

58. (Continued)  
blood smear shows numerous teardrop-shaped red cells, nucleated red cells, and occasional myelocytes. A bone marrow aspirate is unsuccessful, but a biopsy shows a hypercellular marrow with trilineage hyperplasia and findings consistent with the presumed diagnosis of chronic idiopathic myelofibrosis. You transfuse her to a hematocrit of 40%. What is the most appropriate next management step?
- A. Administer erythropoietin
  - B. Follow up in 6 months
  - C. Institute combined-modality chemotherapy
  - D. Perform HLA matching of her siblings
  - E. Perform a splenectomy
59. All the following are suggestive of iron-deficiency anemia *except*
- A. koilonychia
  - B. pica
  - C. decreased serum ferritin
  - D. decreased total iron-binding capacity (TIBC)
  - E. low reticulocyte response
60. You are seeing a patient in follow-up in whom you have begun an evaluation for an elevated hematocrit. You suspect polycythemia vera based on a history of aquagenic pruritus and splenomegaly. Which set of laboratory tests are consistent with the diagnosis of polycythemia vera?
- A. Elevated red blood cell mass, high serum erythropoietin levels, normal oxygen saturation
  - B. Elevated red blood cell mass, low serum erythropoietin levels, normal oxygen saturation
  - C. Normal red blood cell mass, high serum erythropoietin levels, low arterial oxygen saturation
  - D. Normal red blood cell mass, low serum erythropoietin levels, low arterial oxygen saturation
61. Which of the following hemolytic anemias can be classified as extracorpuscular?
- A. Elliptocytosis
  - B. Paroxysmal nocturnal hemoglobinuria
  - C. Pyruvate kinase deficiency
  - D. Sickle cell anemia
  - E. Thrombotic thrombocytopenic purpura
62. You are asked to consult on a 34-year-old man with thrombocytopenia. He sustained a motor vehicle collision 10 days ago, resulting in shock, internal bleeding, and acute renal failure. An exploratory laparotomy was performed that showed
62. (Continued)  
a ruptured spleen requiring a splenectomy. He also underwent an open reduction and internal fixation of the left femur. The platelet count was 260,000 cells/ $\mu$ L on admission. Today it is 68,000 cells/ $\mu$ L. His medications are oxacillin, morphine, and subcutaneous heparin. On examination the vital signs are stable. The examination is significant for an abdominal scar that is clean and healing. The patient's left leg is in a large cast and is elevated. The right leg is swollen from the calf downward. Ultrasound of the right leg shows a deep vein thrombosis. Antiheparin antibodies are positive. Creatinine is 3.2 mg/dL. What is the most appropriate next management step?
- A. Discontinue heparin
  - B. Stop heparin and start enoxaparin
  - C. Stop heparin and start argatroban
  - D. Stop heparin and start lepirudin
  - E. Observe the patient
63. A 64-year-old man with chronic lymphoid leukemia (CLL) and chronic hepatitis C presents for his yearly follow-up. His white blood cell count is stable at 83000/ $\mu$ L, but his hematocrit has dropped from 35% to 26% and his platelet count also dropped from 178,000/ $\mu$ L to 69,000/ $\mu$ L. His initial evaluation should include all of the following *except*
- A. AST, ALT, and prothrombin time
  - B. bone marrow biopsy
  - C. Coombs test
  - D. peripheral blood smear
  - E. physical examination
64. A 64-year-old man with Child-Pugh class B cirrhosis presents to his gastroenterologist complaining of weight loss and a feeling of abdominal fullness. He was diagnosed with hepatitis C cirrhosis 5 years previously. It is thought that the patient developed with hepatitis C following a blood transfusion 20 years ago after a car accident. His initial presentation with cirrhosis was volume overload and ascites. He has been successfully managed with sodium restriction, spironolactone, and furosemide. He has no other significant medical history. On examination today, his liver is enlarged and firm. No ascites is present. A helical CT of the abdomen shows a single tumor in the right lobe of the liver measuring 4 cm in diameter. The location of the mass is near the main portal pedicles. There is no evidence of vascular invasion or metastatic lesions.



64. (Continued)  
The  $\alpha$  fetoprotein level is 384 ng/mL. Biopsy of the mass is diagnostic for hepatocellular carcinoma. What is the best approach for treatment?
- A. Liver transplantation
  - B. Radiofrequency ablation
  - C. Resection of the right hepatic lobe
  - D. Systemic chemotherapy
  - E. Transarterial chemoembolization
65. Which of the following should prompt investigation for hereditary nonpolyposis colon cancer screening in a 32-year-old man?
- A. Father, paternal aunt, and paternal cousin with colon cancer with ages of diagnosis of 54, 68, and 37 years, respectively
  - B. Innumerable polyps visualized on routine colonoscopy
  - C. Mucocutaneous pigmentation
  - D. New diagnosis of ulcerative colitis
  - E. None of the above
66. Which of the following carries the best disease prognosis with appropriate treatment?
- A. Burkitt's lymphoma
  - B. Diffuse large B cell lymphoma
  - C. Follicular lymphoma
  - D. Mantle cell lymphoma
  - E. Nodular sclerosing Hodgkin's disease
67. You are asked to consult on a 31-year-old man with prolonged bleeding after an oral surgery procedure. He has no prior history of bleeding diathesis or family history of bleeding disorders. The patient's past medical history is remarkable for infection with the human immunodeficiency virus, with a CD4 count of 51/ mL<sup>3</sup>. The examination is remarkable only for spotty lymphadenopathy. The platelet count is 230,000 cells/mL. His international normalized ratio (INR) is 1.5. Activated partial thromboplastin time is 40 s. Peripheral blood smear shows no schistocytes and is otherwise unremarkable. A 1:1 mixing study corrects both conditions immediately and after a 2-h incubation. Fibrinogen level is normal. Thrombin time is prolonged. What is the diagnosis?
- A. Disseminated intravascular coagulation (DIC)
  - B. Dysfibrinogenemia
  - C. Factor V deficiency
  - D. Liver disease
  - E. Factor XIII deficiency
68. Chemoprevention strategies for cancer have met with varying levels of success. Which of the following pairings correctly identifies an effective chemoprevention strategy with its target effect?
- A. Aspirin: colon cancer
  - B.  $\beta$ -Carotene: lung cancer
  - C. Calcium: adenomatous gastrointestinal polyps
  - D. Isotretinoin: oral leukoplakia
  - E. Tamoxifen: endometrial cancer
69. A 48-year-old woman is admitted to the hospital with anemia and thrombocytopenia after complaining of profound fatigue. Her initial hemoglobin is 8.5 g/dL, hematocrit 25.7%, and platelet count 42,000/ $\mu$ L. Her leukocyte count is 9540/ $\mu$ L, but 8% blast forms are noted on peripheral smear. A chromosomal analysis shows a reciprocal translocation of the long arms of chromosomes 15 and 17, t(15;17), and a diagnosis of acute promyelocytic leukemia is made. The induction regimen of this patient should include which of the following drugs:
- A. All-*trans*-retinoic acid (ATRA, or tretinoin)
  - B. Arsenic
  - C. Cyclophosphamide, daunorubicin, vinblastine, and prednisone
  - D. Rituximab
  - E. Whole-body irradiation
70. The patient in question 69 is started on the appropriate induction regimen. Two weeks following initiation of treatment, the patient develops acute onset of shortness of breath, fever, and chest pain. Her chest radiograph shows bilateral alveolar infiltrates and moderate bilateral pleural effusions. Her leukocyte count is now 22,300/ $\mu$ L, and she has a neutrophil count of 78%, bands of 15%, and lymphocytes 7%. She undergoes bronchoscopy with lavage that shows no bacterial, fungal, or viral organisms. What is the most likely diagnosis in this patient?
- A. Arsenic poisoning
  - B. Bacterial pneumonia
  - C. Cytomegalovirus pneumonia
  - D. Radiation pneumonitis
  - E. Retinoic acid syndrome
71. A 76-year-old man is admitted to the hospital with complaints of fatigue for 4 months and fever for the past 1 week. His temperature has been as high as 38.3°C at home. During this time, he intermittently has had a 5.5-kg weight loss, severe bruising with minimal trauma, and an aching sensation in

71. (Continued)

his bones. He last saw his primary care physician 2 months ago and was diagnosed with anemia of unclear etiology at that time. He has a history of a previous left middle cerebral artery cerebrovascular accident that has left him with decreased functional status. At baseline, he is able to ambulate in his home with the use of a walker and depends on a caregiver for assistance with his activities of daily living. His vital signs are: blood pressure 158/86 mm Hg, heart rate 98 beats/min, respiratory rate 18 breaths/min, SaO<sub>2</sub> 95%, and temperature 38°C. He appears cachectic with temporal muscle wasting. He has petechiae on his hard palate. He has no lymph node enlargement. On cardiovascular examination, there is a II/VI systolic ejection murmur present. His lungs are clear. The liver is enlarged and palpable 6 cm below the right costal margin. In addition, the spleen is also enlarged, with a palpable spleen tip felt ~4 cm below the left costal margin. There are multiple hematomas and petechiae present in the extremities. Laboratory examination reveals the following: hemoglobin 5.1 g/dL, hematocrit 15%, platelets 12,000/μL, and white blood cell (WBC) count 168,000/μL with 45% blast forms, 30% neutrophils, 20% lymphocytes, and 5% monocytes. Review of the peripheral blood smear confirms acute myeloid leukemia (M1 subtype, myeloblastic leukemia without maturation) with complex chromosomal abnormalities on cytogenetics. All of the following confer a poor prognosis for this patient *except*

- A. advanced age
- B. complex chromosomal abnormalities on cytogenetics
- C. hemoglobin <7 g/dL
- D. prolonged interval between symptom onset and diagnosis
- E. WBC count >100,000/μL

72. A new screening test for thyroid cancer has been introduced into the population. In the first year, 1000 positive tests lead to correct identification of thyroid cancer in the screened population. Over the next year, 250 cases of thyroid cancer are detected among those who initially had a negative test. What is the sensitivity of this new screening test?

- A. 25%
- B. 67%
- C. 80%
- D. Not enough information to calculate

73. A 56-year-old patient inquires about screening for colon cancer. He has no risk factors for colon cancer, other than age. Which of the following statements is true regarding which screening test you recommend for this patient?

- A. 50% of patients with a positive fecal occult blood testing have colon cancer.
- B. Onetime colonoscopy detects more advanced lesions than onetime fecal occult blood testing with sigmoidoscopy.
- C. Perforation rates for sigmoidoscopy and colonoscopy are equivalent.
- D. Sigmoidoscopy has not been shown to reduce mortality.
- E. Virtual colonoscopy is as effective as endoscopic colonoscopy for detecting polyps <5 mm.

74. A 65-year-old man seeks evaluation for nasal congestion, headaches, and dysphagia, most notably when he lies supine for sleeping. These symptoms have been slowly worsening for the past month. He has no nasal discharge or fevers. On review of systems, he reports recent hoarseness and dizziness. His past medical history is significant only for mild hypertension. He worked as a roofing contractor and smoked one pack/day of cigarettes since age 16. On physical examination, you note facial edema. His oropharynx is also mildly edematous, and the tonsils are unremarkable. His external and internal jugular veins are engorged bilaterally, and there are prominent veins on the anterior chest. Chest percussion reveals dullness in the right base with decreased tactile fremitus. A chest radiograph shows a right upper lung mass that on biopsy is consistent with non-small cell lung cancer. All of the following treatments may help this patient's symptoms *except*

- A. chemotherapy
- B. diuretics
- C. glucocorticoids
- D. radiation therapy
- E. venous stenting

75. All of the following statements regarding the epidemiology of and risk factors for acute myeloid leukemias are true *except*

- A. Anticancer drugs such as alkylating agents and topoisomerase II inhibitors are the leading cause of drug-associated myeloid leukemias.
- B. Individuals exposed to high-dose radiation are at risk for acute myeloid leukemia, whereas individuals treated with therapeutic radiation are not unless they are also treated with alkylating agents.

75. (Continued)
- C. Men have a higher incidence of acute myeloid leukemia than women.
  - D. The incidence of acute myeloid leukemia is greatest in individuals <20 years of age.
  - E. Trisomy 21 (Down's syndrome) is associated with an increased risk of acute myeloid leukemia.
76. A 42-year-old man presented to the hospital with right upper quadrant pain. He was found to have multiple masses in the liver that were found to be malignant on H&E staining of a biopsy sample. Your initial history, physical examination, and laboratory tests, including prostate-specific antigen, are unrevealing. Lung, abdominal, and pelvic CT scans are unremarkable. He is an otherwise healthy individual with no chronic medical problems. Which immunohistochemical markers should be obtained from the biopsy tissue?
- A.  $\alpha$  Fetoprotein
  - B. Cytokeratin
  - C. Leukocyte common antigen
  - D. Thyroglobulin
  - E. Thyroid transcription factor 1
77. A 56-year-old woman is diagnosed with chronic myelogenous leukemia, Philadelphia chromosome-positive. Her presenting leukocyte count was 127,000/ $\mu$ L, and her differential shows <2% circulating blasts. Her hematocrit is 21.1% at diagnosis. She is asymptomatic except for fatigue. She has no siblings. What is the best initial therapy for this patient?
- A. Allogeneic bone marrow transplant
  - B. Autologous stem cell transplant
  - C. Imatinib mesylate
  - D. Interferon- $\alpha$
  - E. Leukapheresis
78. All the following are associated with a reduced lifetime risk of developing breast cancer *except*
- A. absence of a history of maternal nursing
  - B. first full-term pregnancy before age 18 years
  - C. menarche after age 15 years
  - D. natural menopause before age 42 years
  - E. surgical menopause before age 42 years
79. All the following cause prolongation of the activated partial thromboplastin time (aPTT) that does not correct with a 1:1 mixture with pooled plasma *except*
- A. lupus anticoagulant
  - B. factor VIII inhibitor
79. (Continued)
- C. heparin
  - D. factor VII inhibitor
  - E. factor IX inhibitor
80. A 53-year-old woman seeks evaluation from her primary care physician regarding primary prevention of cardiovascular disease and stroke. She has a past medical history of type 2 diabetes mellitus for the past 5 years with a known hemoglobin A1C of 7.2%. She does not have hypertension or known coronary artery disease. She has been obese throughout adulthood, and her BMI is 33.6 kg/m<sup>2</sup>. She is currently perimenopausal with irregular bleeding that last occurred 3 months ago. She is taking metformin, 1000 mg, twice daily. She has been intolerant of ibuprofen in the past due to gastrointestinal upset. She previously smoked one pack of cigarettes daily from the ages of 18 to 38. She drinks a glass of wine with dinner. Her family history is significant for myocardial infarction in her father at age 58, paternal uncle at age 67, and paternal grandmother at age 62. On the maternal side, her mother died of a stroke at age 62. She is concerned that she should be taking a daily aspirin as primary prevention of cardiovascular disease and stroke but is also concerned about potential side effects. Which of the following statements regarding aspirin therapy is true?
- A. Aspirin is indicated for primary prevention of cardiovascular disease because she has a strong family history and has a history of diabetes mellitus.
  - B. Aspirin is only indicated for secondary prevention of cardiovascular and cerebrovascular disease in women.
  - C. Because she is not postmenopausal, aspirin therapy is not recommended because it will increase menstrual bleeding without significantly decreasing the risk of cardiovascular disease.
  - D. Her adverse reaction to ibuprofen prevents use of aspirin because there is a high degree of cross-reactivity, and she is at risk for development of bronchospasm with aspirin use.
  - E. The risk of major bleeding related to use of aspirin is 1–3% per year, but use of an enteric-coated or buffered aspirin will eliminate this risk.
81. A 22-year-old man comes into clinic because of a swollen leg. He does not remember any trauma to the leg, but the pain and swelling began 3 weeks ago in the anterior shin area of his left foot. He is a college student and is active in sports daily. A radiograph of the right leg shows a destructive lesion with a “moth-eaten” appearance extending into the soft tissue and a spiculated periosteal reaction.

81. (Continued)  
Codman's triangle (a cuff of periosteal bone formation at the margin of the bone and soft tissue mass) is present. What is the most likely diagnosis and optimal therapy for this lesion?
- A. Chondrosarcoma; chemotherapy alone is curative
  - B. Chondrosarcoma; radiation with limited surgical resection
  - C. Osteosarcoma; preoperative chemotherapy followed by limb-sparing surgery
  - D. Osteosarcoma; radiation therapy
  - E. Plasma cell tumor; chemotherapy
82. Which of the following statements is true?
- A. Factor VIII deficiency is characterized clinically by bleeding into soft tissues, muscles, and weightbearing joints.
  - B. Congenital factor VIII deficiency is inherited in an autosomal recessive fashion.
  - C. Factor VIII deficiency results in prolongation of the prothrombin time.
  - D. Factor VIII complexes with Hageman factor, allowing for a longer half-life.
  - E. Factor VIII has a half-life of nearly 24 h.
83. All of the following statements regarding gastric carcinoma are true *except*
- A. Linitis plastica is an infiltrative form of gastric lymphoma with no defined margins that carries a poorer prognosis than intestinal-type lesions.
  - B. Reduction of tumor bulk with surgery is the best therapeutic option for gastric adenocarcinoma, if surgically feasible.
  - C. The long-term ingestion of high concentrations of nitrates in dried, smoked, or salted foods is associated with higher rates of gastric cancer.
  - D. The presence of palpable, firm periumbilical nodules is a poor prognostic sign.
  - E. Ulcerative lesions in the distal stomach should always undergo brush sampling and biopsy to rule out adenocarcinoma.
84. Which of the following statements correctly describes characteristics of stem cells?
- A. Ability to differentiate into a variety of mature cell types
  - B. Capacity for self-renewal
  - C. Generate, maintain, and repair tissue
  - D. A and C
  - E. A and B
  - F. All of the above
85. Which of the following statements regarding malignant spinal cord compression (MSCC) is true?
- A. Less than 50% of patients who are treated while ambulatory will remain ambulatory.
  - B. Neurologic abnormalities on physical examination are sufficient to initiate high-dose glucocorticoids.
  - C. Neurologic findings often appear before pain.
  - D. Renal cell carcinoma is the most common cause of MSCC.
  - E. The lumbosacral spine is the most commonly affected site.
86. All the following are characteristic of tumor lysis syndrome except
- A. hyperkalemia
  - B. hypercalcemia
  - C. lactic acidosis
  - D. hyperphosphatemia
  - E. hyperuricemia
87. A 22-year-old woman comes to the emergency department complaining of 12 h of shortness of breath. The symptoms began toward the end of a long car ride home from college. She has no past medical history and her only medication is an oral contraceptive. She smokes occasionally but the frequency has increased recently because of examinations. On physical examination, she is afebrile with respiratory rate of 22 breaths/min, blood pressure 120/80 mm Hg, heart rate 110 beats/min, SaO<sub>2</sub> (room air) 92%. The rest of her physical examination is normal. A chest radiograph and complete blood count are normal. Her serum pregnancy test is negative. Which of the following is the indicated management strategy?
- A. Check D-dimer and, if normal, discharge with nonsteroidal anti-inflammatory therapy.
  - B. Check D-dimer and, if normal, obtain lower extremity ultrasound.
  - C. Check D-dimer and, if abnormal, treat for deep vein thrombosis/pulmonary embolism (DVT/PE).
  - D. Check D-dimer and, if abnormal, obtain contrast multislice CT of chest.
  - E. Obtain contrast multislice CT of chest.
88. The patient described in question 87 is found to have a right pulmonary embolus. She is started on low-molecular-weight heparin and warfarin. What is the goal of the international normalized ratio (INR) and the duration of therapy?
- A. INR 3.5; 1 month
  - B. INR 2.5; 3 months

88. (Continued)
- C. INR 3.5; 3 months
  - D. INR 2.5; 6 months
  - E. INR 3.5; 6 months
  - F. INR 2.5; lifetime
89. A patient asks you about the utility of performing monthly breast self-examination (BSE). Which of the following statements is correct regarding the usefulness of and recommendations regarding breast self-examination?
- A. Breast self-examination reduces mortality only in women who undergo breast biopsy.
  - B. Most screening societies recommend performing BSE monthly for women >20 years.
  - C. Self-examination leads to increased biopsy rate.
  - D. Very few breast cancers are first detected by patients.
  - E. Breast self-examination leads to improved survival from breast cancer.
90. Which of the following tumor characteristics confers a poor prognosis in patients with breast cancer?
- A. Estrogen receptor-positive
  - B. Good nuclear grade
  - C. Low proportion of cells in S-phase
  - D. Overexpression of *erbB2* (*HER-2/neu*)
  - E. Progesterone receptor-positive
91. Which of the following serum laboratory tests is most useful for predicting return of renal function in a patient with tumor lysis syndrome and acute renal failure?
- A. Creatinine
  - B. Phosphate
  - C. Potassium
  - D. Serum pH
  - E. Uric acid
92. Fondaparinux may be used to treat all of the following patients *except*
- A. A 33-year-old woman weighing 48 kg presents with a pulmonary embolus 2 months after a motor vehicle accident that resulted in a fractured femur.
  - B. A 46-year-old man with hypertension and focal segmental glomerulosclerosis with a baseline creatinine of 3.3 mg/dL presents with a left lower extremity deep vein thrombosis. He weighs 82 kg.
  - C. A 57-year-old woman had an aortic valve replacement 7 days ago. The platelet count preoperatively was 320,000/ $\mu$ L. On day 7, the platelet count is 122,000/ $\mu$ L.
92. (Continued)
- D. A 60-year-old man presents to the hospital with chest pain and ST-segment depression in leads II, III, and aV<sub>F</sub> on electrocardiogram. Troponin I level is 2.32 ng/mL.
  - E. A 68-year-old man has undergone an uncomplicated right total hip replacement.
93. A 26-year-old woman who is 4 months pregnant is seen for a standard evaluation. She reports feeling well with decreasing nausea over the last 1 month. The physical examination is normal except for the presence of a 1.5-cm hard nodule in the upper outer quadrant of the right breast. She does not recall the nodule being present previously and has not performed self-examination since becoming pregnant. Which of the following is the next most appropriate action?
- A. Aspiration of the nodule
  - B. Mammogram after delivery
  - C. Prescription of oral progesterone therapy
  - D. Recommendation of genetic testing for *BRCA-1*
  - E. Repeat physical examination after delivery
94. Aplastic anemia has been associated with all of the following *except*
- A. carbamazepine therapy
  - B. methimazole therapy
  - C. nonsteroidal inflammatory drugs
  - D. parvovirus B19 infection
  - E. seronegative hepatitis
95. A 23-year-old man presents with diffuse bruising. He otherwise feels well. He takes no medications, does not use dietary supplements, and does not use illicit drugs. His past medical history is negative for any prior illnesses. He is a college student and works as a barista in a coffee shop. A blood count reveals an absolute neutrophil count of 780/ $\mu$ L, hematocrit of 18%, and platelet count of 21,000/ $\mu$ L. Bone marrow biopsy reveals hypocellularity with a fatty marrow. Chromosome studies of peripheral blood and bone marrow cells are performed that exclude Fanconi's anemia and myelodysplastic syndrome. The patient has a fully histocompatible brother. Which of the following is the best therapy?
- A. Anti-thymocyte globulin plus cyclosporine
  - B. Glucocorticoids
  - C. Growth factors
  - D. Hematopoietic stem cell transplant
  - E. Red blood cell and platelet transfusion

96. A 46-year-old woman presents with new-onset ascites and severe abdominal pain: a hepatic Doppler examination reveals hepatic vein thrombosis. She also reports tea-colored urine on occasion, particularly in the morning, as well as recurrent worsening abdominal pain. On further evaluation, she is found to have an undetectable serum haptoglobin, elevated serum lactate dehydrogenase, hemoglobinuria, and an elevated reticulocyte count. A peripheral smear shows no schistocytes. What is the most likely diagnosis?
- A. Adenocarcinoma of the ovary
  - B. Antiphospholipid syndrome
  - C. Aplastic anemia
  - D. Factor V Leiden deficiency
  - E. Paroxysmal nocturnal hemoglobinuria
97. A 16-year-old young man has recurrent thigh hematomas. He has been active in sports all of his life and has had three episodes of limb-threatening bleeding with compartment syndrome. A family history is notable for a maternal grandfather with a similar bleeding history. Paternal family history is not available. Laboratory analysis in clinic reveals a normal platelet count, a normal activated partial thromboplastin time (22 s), and a prolonged prothrombin time (25 s). He takes no medications. What is the most likely reason for his coagulation disorder?
- A. Factor VIII deficiency
  - B. Factor VII deficiency
  - C. Factor IX deficiency
  - D. Prothrombin deficiency
  - E. Surreptitious warfarin ingestion
98. A 52-year-old man is admitted with recurrent hemarthroses of his knees. He is an electrician who is still working but over the last year has had recurrent hemarthroses requiring surgical evacuation. Before 1 year ago, he had no medical problems. He has no other past medical history and seldom sees a physician. He smokes tobacco regularly. His platelet count is normal, erythrocyte sedimentation rate is 55 mm/hr, hemoglobin is 9 mg/dL and albumin is 3.1 mg/dL. Coagulation studies show a prolonged activated partial thromboplastin time (aPTT) and a normal prothrombin time (PT). Adding plasma from a normal subject does not correct the aPTT. What is the cause of his recurrent hemarthroses?
- A. Acquired inhibitor
  - B. Factor VIII deficiency
  - C. Factor IX deficiency
  - D. Secondary syphilis
  - E. Vitamin C deficiency
99. During a preemployment physical and laboratory evaluation, a 20-year-old man is noted to have a prolonged activated prothromblastin time (aPTT). On review of systems, he denies a history of recurrent mucosal bleeding and has never had an issue with other major bleeding. He has never had any major physical trauma. A family history is limited because he does not know his biologic family history. Mixing studies correct the aPTT when normal serum is used. You suspect an inherited hemorrhagic disease such as hemophilia. Which other laboratory abnormality would you most likely expect to find if this patient has hemophilia?
- A. Low factor VIII activity
  - B. Low factor IX activity
  - C. Prolonged bleeding time
  - D. Prolonged prothrombin time
  - E. Prolonged thrombin time
100. You are evaluating a 45-year-old man with an acute upper GI bleed in the emergency department. He reports increasing abdominal girth over the past 3 months associated with fatigue and anorexia. He has not noticed any lower extremity edema. His past medical history is significant for hemophilia A diagnosed as a child with recurrent elbow hemarthroses in the past. He has been receiving infusions of factor VIII for most of his life and received his last injection earlier that day. His blood pressure is 85/45 mm Hg with a heart rate of 115/min. His abdominal examination is tense with a positive fluid wave. Hematocrit is 21%. Renal function and urinalysis is normal. His aPTT is minimally prolonged, his INR is 2.7, platelets are normal. Which of the following is most likely to yield a diagnosis for the cause of his GI bleeding?
- A. Factor VIII activity level
  - B. *H. pylori* antibody test
  - C. Hepatitis B surface antigen
  - D. Hepatitis C RNA
  - E. Mesenteric angiogram
101. You are managing a patient with suspected disseminated intravascular coagulopathy (DIC). The patient has end-stage liver disease awaiting liver transplantation and was recently in the intensive care unit with *E. coli* bacterial peritonitis. You suspect DIC based on a new upper gastrointestinal bleed in the setting of oozing from venipuncture sites. Platelet count is 43,000/ $\mu$ L, INR is 2.5, and

101. (Continued)  
hemoglobin is 6 mg/dL, and D-dimer is elevated to 4.5. What is the best way to distinguish between new-onset DIC and chronic liver disease?
- Blood culture
  - Elevated fibrinogen degradation products
  - Prolonged aPTT
  - Reduced platelet count
  - Serial laboratory analysis
102. A 38-year-old woman is referred for evaluation of an elevated hemoglobin and hematocrit that was discovered during an evaluation of recurrent headaches. Until ~8 months previously, she was in good health but developed increasingly persistent headaches with intermittent vertigo and tinnitus. She was originally prescribed sumatriptan for presumed migraine headaches but did not experience relief of her symptoms. A CT scan of the brain showed no evidence of mass lesion. During evaluation of her headaches, she was found to have a hemoglobin of 17.3 g/dL and a hematocrit of 52%. Her only other symptom is diffuse itching after hot showers. She is a nonsmoker. She has no history pulmonary or cardiac disease. On physical examination, she appears well. Her BMI is 22.3 kg/m<sup>2</sup>. Vitals signs are BP 148/84 mm Hg, HR 86/min, RR 12/min, SaO<sub>2</sub> 99% on room air. She is afebrile. The physical examination including full neurologic examination is normal. There are no heart murmurs. There is no splenomegaly. Peripheral pulses are normal. Laboratory studies confirm elevated hemoglobin and hematocrit. She also has a platelet count of 650,000/ $\mu$ L. Leukocyte count is 12,600/ $\mu$ L with a normal differential. Which of the following tests should be performed next in the evaluation of this patient?
- Bone marrow biopsy
  - Erythropoietin level
  - Genetic testing for JAK2V617F mutation
  - Leukocyte alkaline phosphatase
  - Red cell mass and plasma volume determination
103. A 24-year-old woman presents for a routine checkup and complains only of small masses in her groin. She states that they have been present for at least 3 years. On physical examination, she is noted to have several palpable 1-cm inguinal lymph nodes that are mobile, nontender, and discrete. There is no other lymphadenopathy on examination. What should be the next step in management?
- Bone marrow biopsy
  - CT scan of the chest, abdomen, and pelvis
  - Excisional biopsy
  - Fine-needle aspiration for culture and cytopathology
  - Pelvic ultrasound
  - Reassurance
104. Which of the following findings associated with lymphadenopathy is usually suggestive of metastatic cancer rather than a benign etiology?
- Hard, matted texture of involved nodes
  - Splenomegaly
  - Supraclavicular lymphadenopathy
  - Tender adenopathy of the anterior cervical chain
  - A and B
  - A and C
  - A and D
105. All of the following diseases are associated with massive splenomegaly (spleen extends 8 cm below the costal margin or weighs >1000 g) *except*
- autoimmune hemolytic anemia
  - chronic lymphocytic leukemia
  - cirrhosis with portal hypertension
  - myelofibrosis with myeloid metaplasia
  - none of the above
106. The presence of Howell-Jolly bodies, Heinz bodies, basophilic stippling, and nucleated red blood cells in a patient with hairy cell leukemia prior to any treatment intervention implies which of the following?
- Diffuse splenic infiltration by tumor
  - Disseminated intravascular coagulation (DIC)
  - Hemolytic anemia
  - Pancytopenia
  - Transformation to acute leukemia
107. Which of the following is true regarding infection risk after elective splenectomy?
- Patients are at no increased risk of viral infection after splenectomy.
  - Patients should be vaccinated 2 weeks after splenectomy.
  - Splenectomy patients >50 years of age are at greatest risk for postsplenectomy sepsis.
  - Staphylococcus aureus* is the most commonly implicated organism in postsplenectomy sepsis.
108. What is the main contributor to the resting energy expenditure of an individual?
- Adipose tissue
  - Exercise level

108. (Continued)

- C. Lean body mass
- D. Resting heart rate
- E. None of the above

109. A 49-year-old man is brought to the hospital by his family because of confusion and dehydration. The family reports that for the last 3 weeks he has had persistent copious watery diarrhea that has not abated with the use of over-the-counter medications. The diarrhea has been unrelated to food intake and has persisted during fasting. The stool does not appear fatty and is not malodorous. The patient works as an attorney, is a vegetarian, and has not traveled recently. No one in the household has had similar symptoms. Before the onset of diarrhea, he had mild anorexia and a 5-lb weight loss. Since the diarrhea began, he has lost at least 10 pounds. The physical examination is notable for blood pressure of 100/70, heart rate of 110/min, and temperature of 36.8°C (98.2°F). Other than poor skin turgor, confusion, and diffuse muscle weakness, the physical examination is unremarkable. Laboratory studies are notable for a normal complete blood count and the following chemistry results:

Na <sup>+</sup>	146 meq/L
K <sup>+</sup>	3.0 meq/L
Cl <sup>-</sup>	96 meq/L
HCO <sub>3</sub> <sup>-</sup>	36 meq/L
BUN	32 mg/dL
Creatinine	1.2 mg/dL

A 24-h stool collection yields 3 L of tea-colored stool. Stool sodium is 50 meq/L, potassium is 25 meq/L, and stool osmolality is 170 mosmol/L. Which of the following diagnostic tests is most likely to yield the correct diagnosis?

- A. Serum cortisol
- B. Serum TSH
- C. Serum VIP
- D. Urinary 5-HIAA
- E. Urinary metanephrine

110. A 45-year-old man is diagnosed with pheochromocytoma after presentation with confusion, marked hypertension to 250/140 mm Hg, tachycardia, headaches, and flushing. His fractionated plasma metanephrines show a normetanephrine level of 560 pg/mL and a metanephrine level of 198 pg/mL (normal values: normetanephrine: 18–111 pg/mL; metanephrine: 12–60 pg/mL). CT scanning of the abdomen with IV contrast demonstrates a 3-cm mass in the right adrenal gland.

110. (Continued)

A brain MRI with gadolinium shows edema of the white matter near the parietooccipital junction consistent with reversible posterior leukoencephalopathy. You are asked to consult regarding management. Which of the following statements is true regarding management of pheochromocytoma in this individual?

- A. Beta-blockade is absolutely contraindicated for tachycardia even after adequate alpha-blockade has been attained.
- B. Immediate surgical removal of the mass is indicated because the patient presented with hypertensive crisis with encephalopathy.
- C. Salt and fluid intake should be restricted to prevent further exacerbation of the patient's hypertension.
- D. Treatment with phenoxybenzamine should be started at a high dose (20–30 mg three times daily) to rapidly control blood pressure, and surgery can be undertaken within 24–48 h.
- E. Treatment with IV phentolamine is indicated for treatment of the hypertensive crisis. Phenoxybenzamine should be started at a low dose and titrated to the maximum tolerated dose over 2–3 weeks. Surgery should not be planned until the blood pressure is consistently <160/100 mm Hg.

111. A 33-year-old woman presents to the emergency department complaining of headache, palpitations, sweating, and anxiety. These feelings began abruptly ~30 min ago, and she reports intermittent symptoms similar to these that occur perhaps once per month. She has previously been diagnosed with panic attacks and has been prescribed paroxetine, 20 mg daily. Her symptoms have not improved since initiation of this drug, and she believes that her episodes of palpitations and anxiety have worsened since this time. Her past medical history includes a diagnosis of hypertension, but treatment with amlodipine has recently been discontinued because her blood pressure was 88/50 mm Hg with symptomatic orthostasis at her last visit with her primary care provider. Her only other medical history is headaches for the past year for which she has been prescribed ibuprofen, 600 mg, as needed. She believes the headaches accompany her episodes and last for several hours after the sweating has subsided. On physical examination, the patient appears flushed and diaphoretic. Her blood pressure while lying down is 170/100 mm Hg with a heart rate of 90 beats/min. Upon standing her blood pressure falls to 132/74 mm Hg with a heart rate of 112 beats/min. Her respiratory rate is 22 beats/min, and her temperature is 37.4°C. Her examination is



111. (Continued)

otherwise normal. There is no papilledema. Which of the following is most likely to correctly diagnose this patient?

- A. A 24-h urine collection for 5-hydroxyindoleacetic acid (5-HIAA)
- B. A 24-h urine collection for fractionated metanephrines
- C. CT scan of the abdomen with intravenous contrast
- D. <sup>131</sup>I-metaiodobenzylguanidine scan (MIBG)
- E. No testing is necessary; the patient is suffering from a panic attack

112. A healthy 53-year-old man comes to your office for an annual physical examination. He has no complaints and has no significant medical history. He is taking an over-the-counter multivitamin and no other medicines. On physical examination he is noted to have a nontender thyroid nodule. His thyroid-stimulating hormone (TSH) level is checked and found to be low. What is the next step in his evaluation?

- A. Close follow-up and measure TSH in 6 months
- B. Fine-needle aspiration
- C. Low-dose thyroid replacement
- D. Positron emission tomography followed by surgery
- E. Radionuclide thyroid scan

113. A 48-year-old woman is undergoing evaluation for flushing and diarrhea. Physical examination is normal except for nodular hepatomegaly. A CT scan of the abdomen demonstrates multiple nodules in both lobes of the liver consistent with metastases in the liver and a 2-cm mass in the ileum. The 24-h urinary 5-HIAA excretion is markedly elevated. All the following treatments are appropriate *except*

- A. diphenhydramine
- B. interferon- $\alpha$
- C. octreotide
- D. odansetron
- E. phenoxybenzamine

114. While undergoing a physical examination during medical student clinical skills, this patient develops severe flushing, wheezing, nausea, and light-headedness.

114. (Continued)

Vital signs are notable for a blood pressure of 70/30 mm Hg and a heart rate of 135/min. Which of the following is the most appropriate therapy?

- A. Albuterol
- B. Atropine
- C. Epinephrine
- D. Hydrocortisone
- E. Octreotide

115. A 35-year-old man is referred to your clinic for evaluation of hypercalcemia noted during a health insurance medical screening. He has noted some fatigue, malaise, and a 4-lb weight loss over the last 2 months. He also has noted constipation and "heartburn." He is occasionally nauseated after large meals and has water brash and a sour taste in his mouth. The patient denies vomiting, dysphagia, or odynophagia. He also notes decreased libido and a depressed mood. Vital signs are unremarkable. Physical examination is notable for a clear oropharynx, no evidence of a thyroid mass, and no lymphadenopathy. Jugular venous pressure is normal. Heart sounds are regular with no murmurs or gallops. The chest is clear. The abdomen is soft with some mild epigastric tenderness. There is no rebound or organomegaly. Stool is guaiac-positive. Neurologic examination is nonfocal. Laboratory values are notable for a normal complete blood count. Calcium is 11.2 mg/dL, phosphate is 2.1 mg/dL, and magnesium is 1.8 meq/dL. Albumin is 3.7 g/dL, and total protein is 7.0 g/dL. TSH is 3  $\mu$ IU/mL, prolactin is 250  $\mu$ g/L, testosterone is 620 ng/dL, and serum insulin-like growth factor 1 (IGF-1) is normal. Serum intact parathyroid hormone level is 135 pg/dL. In light of the patient's abdominal discomfort and heme-positive stool, you perform an abdominal computed tomography (CT) scan that shows a lesion measuring 2 cm by 2 cm in the head of the pancreas. What is the diagnosis?

- A. Multiple endocrine neoplasia (MEN) type 1
- B. MEN type 2a
- C. MEN type 2b
- D. Polyglandular autoimmune syndrome
- E. Von Hippel-Lindau (VHL) syndrome

**ANSWERS**

1. The answer is B.

(Chap. 42) Bone pain resulting from metastatic lesions may be difficult to distinguish from degenerative disease, osteoporosis, or disk disease in the elderly. Generally, these patients present with insidious worsening localized pain without fevers or signs of infection. In contrast to pain related to disk disease, the pain of metastatic disease is worse when the patient is lying down or at night. Neurologic symptoms related to metastatic disease constitute an emergency. Lung, breast, and prostate cancers account for ~80% of bone metastases. Thyroid carcinoma, renal cell carcinoma, lymphoma, and bladder carcinoma may also metastasize to bone. Metastatic lesions may be lytic or blastic. Most cancers cause a combination of both, although prostate cancer is predominantly blastic. Either lesion may cause hypercalcemia, although lytic lesions more commonly do this. Lytic lesions are best detected with plain radiography. Blastic lesions are prominent on radionuclide bone scans. Treatment and prognosis depend on the underlying malignancy. Bisphosphonates may reduce hypercalcemia, relieve pain, and limit bone resorption.

2. The answer is B.

(Chap. 10) Red blood cells use glutathione produced by the hexose monophosphate shunt to compensate for increased production of reactive oxygen species (oxidant stress), usually induced by drugs or toxins. Defects in G6PD are the most common congenital hexose monophosphate shunt defect. If the red blood cell (RBC) is unable to maintain an adequate level of glutathione during oxidant stress, hemoglobin precipitates in the RBC, producing Heinz bodies. Because the G6PD gene is on the X chromosome, almost all afflicted patients are males. G6PD deficiency is widely distributed throughout regions that are currently or were once highly malarial endemic. It is common in males of African, African American, Sardinian, and Sephardic descent. In most persons with G6PD deficiency, there is no evidence of symptomatic disease. However, infection, ingestion of fava beans, or exposure to an oxidative agent (drug or toxin) can trigger an acute hemolytic event. Bite cells, Heinz bodies, and bizarre poikilocytes may be evident on smear. The drugs that most commonly precipitate a G6PD crisis include dapsone, sulfamethoxazole, primaquine, and nitrofurantoin. The anemia is often severe with rapid onset after drug ingestion, and renal failure can occur.

3. The answer is E.

(Chaps. 19 and 20) Vitamin K is a fat-soluble vitamin that plays an essential role in hemostasis. It is absorbed in the small intestine and stored in the liver. It serves as a cofactor in the enzymatic carboxylation of glutamic acid

residues on prothrombin-complex proteins. The three major causes of vitamin K deficiency are poor dietary intake, intestinal malabsorption, and liver disease. The prothrombin complex proteins (factors II, VII, IX, and X and protein C and protein S) all decrease with vitamin K deficiency. Factor VII and protein C have the shortest half-lives of these factors and therefore decrease first. Therefore, vitamin K deficiency manifests with prolongation of the prothrombin time first. With severe deficiency, the aPTT will be prolonged as well. Factor VIII is not influenced by vitamin K.

4. The answer is E.

(Chaps. 19 and 20) Hemophilia A results from a deficiency of factor VIII. Replacement of factor VIII is the centerpiece of treatment. Cessation of aspirin or nonsteroidal anti-inflammatory drugs (NSAIDs) is highly recommended. FFP contains pooled plasma from human sources. Cryoprecipitate refers to FFP that is cooled, resulting in the precipitation of material at the bottom of the plasma. This product contains about half the factor VIII activity of FFP in a tenth of the volume. Both agents are therefore reasonable treatment options. DDAVP causes the release of a number of factors and von Willebrand's factor from the liver and endothelial cells. This may be useful for patients with mild hemophilia. Recombinant or purified factor VIII (i.e., Humate P) is indicated in patients with more severe bleeding. Therapy may be required for weeks, with levels of factor VIII kept at 50%, for postsurgical or severe bleeding. Plasmapheresis has no role in the treatment of hemophilia A.

5. The answer is A.

(Chap. 36) Hepatocellular carcinoma (HCC) is one of the most common cancers worldwide with the highest incidence in Southeast Asia and sub-Saharan Africa. However, the incidence of HCC in the United States is rapidly increasing and is thought to be related to an increase in the number of individuals infected with hepatitis C. At present, ~4 million individuals are infected with hepatitis C, of whom 10% have cirrhosis. Of those who develop cirrhosis due to hepatitis C, ~5% will develop HCC. Other common risk factors for development of HCC include cirrhosis from any cause, chronic hepatitis B or C infection, alcoholism, nonalcoholic steatohepatitis, aflatoxin B exposure, and primary biliary cirrhosis. Aflatoxin B is a mycotoxin produced by *Aspergillus* species that is found in stored grains in hot and humid places. It is the best studied and most potent naturally occurring carcinogen associated with HCC. In the United States, ~20% of individuals diagnosed with HCC do not have cirrhosis. In these individuals, the etiology of HCC is unknown, and the natural history is not well defined.

6. The answer is C.

(Chap. 2) This blood smear shows fragmented red blood cells of varying size and shape. In the presence of a foreign body within the circulation (prosthetic heart valve, vascular graft), red blood cells can become destroyed. Such intravascular hemolysis will also cause serum lactate dehydrogenase to be elevated and hemoglobinuria. In isolated extravascular hemolysis, there is no hemoglobin or hemosiderin released into the urine. The characteristic peripheral blood smear in splenomegaly is the presence of Howell-Jolly bodies (nuclear remnants within red blood cells). Certain diseases are associated with extramedullary hematopoiesis (e.g., chronic hemolytic anemias), which can be detected by an enlarged spleen, thickened calvarium, myelofibrosis, or hepatomegaly. The peripheral blood smear may show teardrop cells or nucleated red blood cells. Hypothyroidism is associated with macrocytosis, which is not demonstrated here. Chronic gastrointestinal blood loss will cause microcytosis, not schistocytes.

7. The answer is C.

(Chap. 50) One of the better characterized paraneoplastic neurologic syndromes is cerebellar ataxia caused by Purkinje cell dropout in the cerebellum; it is manifested by dysarthria, limb and gait ataxia, and nystagmus. Radiologic imaging reveals cerebellar atrophy. Many antibodies have been associated with this syndrome, including anti-Yo, anti-Tr, and antibodies to the glutamate receptor. Although lung cancer, particularly small cell cancer, accounts for a large number of patients with neoplasm-associated cerebellar ataxia, those with the syndrome who display anti-Yo antibodies in the serum typically have breast or ovarian cancer.

8. The answer is B.

(Chap. 10) This patient's lupus and her rapid development of truly life-threatening hemolytic anemia are both very suggestive of autoimmune hemolytic anemia. Diagnosis is made by a positive Coombs test documenting antibodies to the red cell membrane, but smear will often show microspherocytes, indicative of the damage incurred to the red cells in the spleen. Schistocytes are typical for microangiopathic hemolytic anemias such as hemolytic-uremic syndrome (HUS) or thrombocytopenic thrombotic purpura (TTP). The lack of thrombocytopenia makes these diagnoses considerably less plausible. Macrocytosis and PMN's with hypersegmented nuclei are very suggestive of vitamin B<sub>12</sub> deficiency, which causes a more chronic, non-life-threatening anemia. Target cells are seen in liver disease and thalassemias. Sick cell anemia is associated with aplastic crises, but she has no known diagnosis of sickle cell disease and is showing evidence of erythropoietin response based on the presence of elevated reticulocyte count.

9. The answer is A.

(Chap. 2) An accurate reticulocyte count is a critical component of the laboratory workup of anemia. Two corrections need to be made to the reticulocyte count when it is being used to estimate the marrow's response to anemia. The first correction adjusts the reticulocyte count for the number of circulating red cells (i.e., the percentage of reticulocytes may be increased although the absolute number is unchanged). The absolute reticulocyte count = reticulocyte count \* (hematocrit/expected hematocrit). Second, when there is evidence of prematurely released reticulocytes on the blood smear (polychromatophilia), prolonged maturation in the serum may cause a falsely high estimate of daily red blood cell production. Correction is achieved by dividing by a "maturation time correction," usually 2 if the hematocrit is between 25% and 35%. In this example, the reticulocyte production index is:  $5 * (25/45)/2$ , or 1.4. If a reticulocyte production index is  $<2$  in the face of anemia, a defect in erythroid marrow proliferation must be present. Gastrointestinal bleeding should be considered in this demographic; however, a low reticulocyte count with normal iron stores argues strongly for a defect in erythroid proliferation. A ferritin  $>200$   $\mu\text{g/L}$  indicates that there are some iron stores present. Clues for extravascular hemolysis include an elevated lactate dehydrogenase, spherocytes on the peripheral blood smear, and hepatosplenomegaly. Intravascular hemolysis (disseminated intravascular coagulation, mechanical heart valve, thrombotic thrombocytopenic purpura) will show schistocytes on peripheral smear.

10. The answer is D.

(Chap. 11) Pure red cell aplasia is a normochromic, normocytic anemia with absent erythroblasts on the bone marrow, hence the diminished number or lack of reticulocytes. The bone marrow shows red cell aplasia and the presence of giant pronormoblasts. Several conditions have been associated with pure red cell aplasia, including viral infections such as B19 parvovirus (which can have cytopathic bone marrow changes), HIV, EBV, HTLV, and hepatitis B virus; malignancies such as thymomas and lymphoma (which often present with an anterior mediastinal mass); connective tissue disorders such as SLE and rheumatoid arthritis (RA); pregnancy; drugs; and hereditary disorders. Erythropoietin levels are elevated because of the anemia.

11. The answer is A.

(Chap. 35) This patient has *Streptococcus bovis* endocarditis. For unknown reasons, individuals who develop endocarditis or septicemia from this fecal organism have a high frequency of having occult colorectal carcinomas. Upper gastrointestinal tumors have been described as well. All patients with *S. bovis* endocarditis should receive colonoscopy after stabilization. Tobacco use has been

linked to the development of colorectal adenomas, particularly after >35 years of tobacco use, again for unknown reasons. Patients with illicit drug use (diagnosed by toxicology screen) are at risk of endocarditis due to *Staphylococcus aureus*. A head CT scan looking for embolic lesions is not necessary in the absence of physical findings or large vegetations that are prone to embolize. Patients with endocarditis often have renal abnormalities, including microscopic hematuria from immune complex deposition, but a renal biopsy to evaluate for glomerulonephritis is not indicated in the presence of documented endocarditis. A pulmonary embolus, although certainly a possible event during hospitalization, would not be associated with the acute presentation of *S. bovis* endocarditis.

12. The answer is A.

(Chap. 36) This patient is presenting with painless jaundice and acholic stools. On right upper quadrant ultrasound, the gallbladder cannot be visualized, suggesting collapse of the gallbladder. In addition, there is dilatation of the intrahepatic bile ducts, but not the common bile duct, suggesting a tumor at the bifurcation of the common bile duct. This tumor is a type of cholangiocarcinoma called a *Klatskin tumor*. The incidence of cholangiocarcinoma appears to be increasing. In general, the cause of most cholangiocarcinoma is unknown, but there is an increased risk in primary sclerosing cholangitis, liver flukes, alcoholic liver disease, and any cause of chronic biliary injury. Cholangiocarcinoma typically presents as painless jaundice. Imaging usually shows dilatation of the bile ducts, and the extent of dilatation depends on the site of obstruction. Diagnosis is usually made during endoscopic retrograde cholangiopancreatography (ERCP), which defines the biliary tree and allows a biopsy to be taken. Hilar cholangiocarcinoma is resectable in ~30% of patients, and the mean survival is ~24 months. Cholecystitis is typically associated with fever, chills, and abdominal pain. The degree of jaundice would not be expected to be as high as is seen in this patient. Gallbladder cancer should present with a gallbladder mass rather than a collapsed gallbladder, and chronic right upper quadrant pain is usually present. Hepatocellular carcinoma may be associated with painless jaundice but is not associated with dilatation of intrahepatic bile ducts and the marked elevation in alkaline phosphatase. Malignancy at the head of the pancreas may present in a similar fashion but should not result in gallbladder collapse. In addition, the common bile duct should be markedly dilated.

13. The answer is E.

(Chap. 49) Hypercalcemia is a common oncologic complication of metastatic cancer. Symptoms include confusion, lethargy, change in mental status, fatigue, polyuria, and constipation. Regardless of the underlying disease, the

treatment is similar. These patients are often dehydrated because hypercalcemia may cause a nephrogenic diabetes insipidus, and they are often unable to take fluids orally. Therefore, the primary management entails reestablishment of euvoemia. Often hypercalcemia resolves with hydration alone. Bisphosphonates are another mainstay of therapy because they stabilize osteoclast resorption of calcium from the bone. However, their effects may take 1 to 2 days to manifest. Care must be taken in cases of renal insufficiency because rapid administration of pamidronate may exacerbate renal failure. Once euvoemia is achieved, furosemide may be given to increase calciuresis. Nasal or subcutaneous calcitonin further aids the shift of calcium out of the intravascular space. Glucocorticoids may be useful in patients with lymphoid malignancies because the mechanism of hypercalcemia in those conditions is often related to excess hydroxylation of vitamin D. However, in this patient with prostate cancer, dexamethasone will have little effect on the calcium level and may exacerbate the altered mental status.

14. The answer is C.

(Chap. 40) Ninety percent of persons with nonseminomatous germ cell tumors produce either AFP or  $\beta$ -hCG; in contrast, persons with pure seminomas usually produce neither. These tumor markers are present for some time after surgery; if the presurgical levels are high,  $\geq 30$  days may be required before meaningful postsurgical levels can be obtained. The half-lives of AFP and  $\beta$ -hCG are 6 days and 1 day, respectively. After treatment, unequal reduction of  $\beta$ -hCG and AFP may occur, suggesting that the two markers are synthesized by heterogeneous clones of cells within the tumor; thus both markers should be followed.  $\beta$ -hCG is similar to luteinizing hormone except for its distinctive beta subunit.

15. The answer is C.

(Chap. 51) Abdominal pain can be a sign of an oncologic emergency, both obstructive and/or metabolic. The differential diagnosis is broad; however, when there is obstruction, constipation and colicky abdominal pain are prominent. The pain may also be exacerbated postprandially. Normal imaging, moreover, suggests the abnormality is metabolic or may be due to peritoneal metastases too small to be seen on standard imaging. Adrenal insufficiency is suggested by mild hyponatremia and hyperkalemia, the history of breast cancer, and use of megestrol acetate. Adrenal insufficiency may go unrecognized because the symptoms such as nausea, vomiting, orthostasis, or hypotension may be mistakenly attributed to progressive cancer or to therapy.

16. The answer is B.

(Chap. 35) Most colorectal cancers arise from adenomatous polyps. Only adenomas are premalignant, and only a minority of these lesions becomes malignant. Most

polyps are asymptomatic, causing occult bleeding in <5% of patients. Sessile (flat-based) polyps are more likely to become malignant than pedunculated (stalked) polyps. Histologically, villous adenomas are more likely to become malignant than tubular adenomas. The risk of containing invasive carcinoma in the polyp increases with size with <2% in polyps <1.5 cm, 2–10% in polyps 1.5–2.5 cm, and 10% in polyps >2.5 cm. This patient had two polyps that were high risk based on histology (villous) and appearance (sessile) but only moderate risk by size (<1.5 cm). Polyps, particularly those >2.5 cm in size, sometimes contain cancer cells but usually progress to cancer quite slowly over a ~5-year period. Patients with adenomatous polyps should have a follow-up colonoscopy or radiographic study in 3 years. If no polyps are found on initial study, the test (endoscopic or radiographic) should be repeated in 10 years. CT scan is only warranted for staging if there is a diagnosis of colon cancer, not for the presence of polyps alone

17. The answer is A.

(Chap. 13) Polycythemia vera (PV) is a clonal disorder that involves a multipotent hematopoietic progenitor cell. Clinically, it is characterized by a proliferation of red blood cells, granulocytes, and platelets. The precise etiology is unknown. Erythropoiesis is regulated by the hormone erythropoietin. Hypoxia is the physiologic stimulus that increases the number of cells that produce erythropoietin. Erythropoietin may be elevated in patients with hormone-secreting tumors. Levels are usually “normal” in patients with hypoxic erythrocytosis. In polycythemia vera, however, because erythrocytosis occurs independently of erythropoietin, levels of the hormone are usually low. Therefore, an elevated level is *not* consistent with the diagnosis. Polycythemia is a chronic, indolent disease with a low rate of transformation to acute leukemia, especially in the absence of treatment with radiation or hydroxyurea. Thrombotic complications are the main risk for PV and correlate with the erythrocytosis. Thrombocytosis, although sometimes prominent, does not correlate with the risk of thrombotic complications. Salicylates are useful in treating erythromelalgia but are not indicated in asymptomatic patients. There is no evidence that thrombotic risk is significantly lowered with their use in patients whose hematocrits are appropriately controlled with phlebotomy. Phlebotomy is the mainstay of treatment. Induction of a state of iron deficiency is critical to prevent a reexpansion of the red blood cell mass. Chemotherapeutics and other agents are useful in cases of symptomatic splenomegaly. Their use is limited by side effects, and there is a risk of leukemogenesis with hydroxyurea.

18. The answer is C.

(Chap. 44) The patient presents with symptoms suggestive of ovarian cancer. Although her peritoneal fluid is

positive for adenocarcinoma, further speciation cannot be done. Surprisingly, the physical examination and imaging do not show a primary source. Although the differential diagnosis of this patient’s disorder includes gastric cancer or another gastrointestinal malignancy and breast cancer, peritoneal carcinomatosis most commonly is due to ovarian cancer in women, even when the ovaries are normal at surgery. Elevated CA-125 levels or the presence of psammoma bodies is further suggestive of an ovarian origin, and such patients should receive surgical debulking and carboplatin or cisplatin plus paclitaxel. Patients with this presentation have a similar stage-specific survival compared with other patients with known ovarian cancer. Ten percent of patients with this disorder, also known as primary peritoneal papillary serous carcinoma, remain disease-free 2 years after treatment.

19. The answer is C.

(Chap. 11) Pure red cell aplasia (PRCA) is a condition characterized by the absence of reticulocytes and erythroid precursors. A variety of conditions may cause PRCA. It may be idiopathic. It may be associated with certain medications, such as trimethoprim-sulfamethoxazole (TMP-SMX) and phenytoin. It can be associated with a variety of neoplasms, either as a precursor to a hematologic malignancy such as leukemia or myelodysplasia or as part of an autoimmune phenomenon, as in the case of thymoma. Infections also may cause a pure red cell aplasia. Parvovirus B19 is a single-strand DNA virus associated with erythema infectiosum, or fifth disease, in children. It is also associated with arthropathy and a flulike illness in adults. It is thought to attack the P antigen on proerythroblasts directly. Patients with a chronic hemolytic anemia, such as sickle cell disease, or with an immunodeficiency are less able to tolerate a transient drop in reticulocytes because their red blood cells do not survive in the peripheral blood for an adequate period. In this patient, her daughter had an illness before the appearance of her symptoms. It is reasonable to check her parvovirus IgM titers. If they are positive, a dose of intravenous immunoglobulin is indicated. Because her laboratories and smear are not suggestive of dramatic sickling, an exchange transfusion is not indicated. Immunosuppression with prednisone and/or cyclosporine may be indicated if another etiology of the PRCA is identified. However, that would not be the next step. Similarly, a bone marrow transplant might be a consideration in a young patient with myelodysplasia or leukemia, but there is no evidence of that at this time. Antibiotics have no role in light of her normal white blood cell count and the lack of evidence for a bacterial infection.

20. The answer C.

(Chap. 10) Hereditary spherocytosis is a heterogeneous red cell membranopathy that can be either congenital

(usually autosomal dominant) or acquired; it is characterized by predominantly extravascular hemolysis in the spleen due to defects in membrane structural proteins. This spleen-mediated hemolysis leads to the conversion of classic biconcave red blood cells on smear to spherocytes. Splenomegaly is common. This disorder can be severe, depending on the site of mutation, but is often overlooked until some stressor such as pregnancy leads to a multifactorial anemia, or an infection such as parvovirus B19 transiently eliminates red cell production altogether. The peripheral blood smear shows microspherocytes, small densely staining red blood cells that have lost their central pallor. Acute treatment is with transfusion. G6PD deficiency is a cause of hemolysis that is usually triggered by the presence of an offending oxidative agent. The peripheral blood smear may show Heinz bodies. Parvovirus infection may cause a pure red cell aplasia. The presence of active reticulocytosis and laboratory findings consistent with hemolysis are not compatible with that diagnosis. Chronic gastrointestinal blood loss, such as due to a colonic polyp, would cause a microcytic, hypochromic anemia without evidence of hemolysis (indirect bilirubin, haptoglobin abnormalities).

21. The answer is E.

(Chap. 51) Hyperleukocytosis is a potentially fatal complication of acute leukemia when the blast count is  $>100,000/\mu\text{L}$ . Complications of the syndrome are mediated by hyperviscosity, tumor aggregates causing slow blood flow, and invasion of the primitive leukemic cells, which cause hemorrhage. The brain and lungs are most commonly involved. The pulmonary syndrome may lead to respiratory distress and progressive respiratory failure. Chest radiographs may show either alveolar or interstitial infiltrates. A common finding in patients with markedly elevated immature white blood cell counts is low arterial oxygen tension on arterial blood gas with a normal pulse oximetry. This may actually be due to pseudohypoxemia because white blood cells rapidly consume plasma oxygen during the delay between collecting arterial blood and measuring oxygen tension, causing a spuriously low measured oxygen tension. Placing the arterial blood gas immediately in ice will prevent the pseudohypoxemia. The bcr-abl mutation is found in up to 25% of patients with ALL. In addition, as tumor cells lyse, lactate dehydrogenase levels can rise rapidly. Methemoglobinemia is usually due to exposure to oxidizing agents such as antibiotics or local anesthetics. Respiratory symptoms may develop when methemoglobin levels are  $>10\text{--}15\%$  (depending on hemoglobin concentration). Typically arterial  $\text{PaO}_2$  is normal and measured  $\text{SaO}_2$  is inappropriately reduced because pulse oximetry is inaccurate with high levels of methemoglobin.

22. The answer is D.

(Chap. 33.) The evaluation of a solitary pulmonary nodule (SPN) remains a combination of art and science.

Approximately 50% of SPNs ( $<3.0$  cm) turn out to be malignant, but studies have found a range between 10% and 70%, depending on patient selection. If the SPN is malignant, surgical therapy can result in 80% 5-year survival. Most benign lesions are infectious granulomas. Spiculated or scalloped lesions are more likely to be malignant, whereas lesions with central or popcorn calcification are more likely to be benign. Masses ( $>3.0$  cm) are usually malignant.  $^{18}\text{F}$ FDG PET scanning has added a new test to the options for evaluating a SPN. PET has  $>95\%$  sensitivity and 75% specificity for identifying a malignant SPN. False negatives occur with small ( $<1$  cm) tumors, bronchoalveolar carcinomas, and carcinoid tumors. False positives are usually due to inflammation. In this patient with a moderate risk of malignancy (age  $>45$  years, lesion  $>1$  cm, positive smoking history, suspicious lesion, no prior radiogram demonstrating the lesion) a PET scan would be the most reasonable choice. PET is also useful for staging disease. The diagnostic accuracy of PET for malignant mediastinal lymph nodes approaches 90%. Another option would be a transthoracic needle biopsy, with a sensitivity of 80–95% and a specificity of 50–85%. Transthoracic needle aspiration has the best results and the fewest complications (pneumothorax) with peripheral lesions versus central lesions. Bronchoscopy has a very poor yield for lesions  $<2$  cm. Mediastinoscopy would be of little value unless PET or CT raised a suspicion of nodal disease. MRI scan will not add any information and is less able than CT to visualize lesions in the lung parenchyma. A repeat chest CT is a reasonable option for a patient with a low clinical suspicion.

23. The answer is A.

(Chap. 43) About 25% of patients with cancer die with intracranial metastases. Symptoms may relate to parenchymal or leptomeningeal involvement. The signs and symptoms of metastatic brain tumor are similar to those of other intracranial expanding lesions: headache, nausea, vomiting, behavioral changes, seizures, and focal neurologic deficits. An estimated 3–8% of patients with cancer develop a tumor involving the leptomeninges. These patients typically present with multifocal neurologic signs and symptoms. Signs include cranial nerve palsies, extremity weakness, paresthesias, and loss of deep tendon reflexes. CT and MRI are useful in establishing the diagnosis of intraparenchymal lesions. The treatment of choice is radiotherapy. Solitary lesions in selected patients may be resected to achieve improved disease-free survival. The diagnosis of leptomeningeal disease is made by demonstrating tumor cells in the cerebrospinal fluid (CSF). Each attempt has limited sensitivity, and so patients with clinical features suggestive of leptomeningeal disease should undergo three serial CSF samplings. Neoplastic meningitis usually occurs in the setting of uncontrolled cancer outside the CNS. Therefore, the prognosis is

typically dismal, with a median survival between 10 and 12 weeks.

24. The answer is C.

(Chap. 22) Warfarin is the most widely used oral anticoagulant. Its mechanism of action is to interfere with production of the vitamin K–dependent procoagulant factors (prothrombin and factors VII, IX, and X) and anticoagulant factors (proteins C and S). Warfarin accumulates in the liver when it undergoes oxidative metabolism by the CYP2C9 system. Multiple medications can interfere with the metabolism of warfarin by this system causing both over- and underdosing of warfarin. This patient has recently been treated with a fluoroquinolone antibiotic known to increase the prothrombin time and INR if the warfarin dose is not adjusted during treatment. When the INR is  $>6$ , there is a greater risk of development of bleeding complications. However, if no evidence of bleeding is present at presentation, it is safe to hold warfarin and allow the INR to fall gradually into the therapeutic range before reinstating therapy (DA Garcia: *J Am Coll Cardiol* 47:804, 2006; J Ansell et al: *Chest* 126:204S, 2004). In this patient, however, there is evidence of minor bleeding complications warranting treatment. She likely has developed a degree of hemorrhagic cystitis due to over-anticoagulation in the setting of a urinary tract infection, which had already inflamed the bladder lining. In addition, she had developed multiple ecchymoses. Thus treatment of the elevated INR is indicated. In the absence of life-threatening bleeding, treatment with vitamin K is indicated. When the INR falls between 4.9 and 9, an oral dose of vitamin K, 1 mg, is usually adequate to correct the INR without conferring vitamin K resistance, evidenced by decreased sensitivity to oral warfarin for an extended period. When a more rapid correction of anticoagulation is needed, vitamin K can be given by the IV or IM route. However, there is a risk of anaphylaxis, shock, and death. This can be minimized by delivering the drug slowly at a rate of  $\leq 1$  mg/min. Additionally, fresh-frozen plasma is indicated to replete coagulation factors when there is significant bleeding in the setting of an elevated INR. Although the SC route for delivery of vitamin K has long been a primary route of correction, a meta-analysis has shown the SC route to be no better than placebo and inferior to the oral and IV routes, which have similar efficacy (KJ Dezee et al.).

25. The answer is D.

(Chap. 52) Cancer is the second leading cause of mortality in the United States. Millions of Americans who are alive today have cancer in their past history. Cardiac toxicity is typically related to prior treatment with anthracycline-based chemotherapy or mediastinal irradiation. This is seen most commonly in patients who have survived Hodgkin's or non-Hodgkin's lymphoma. Anthracycline-related

cardiotoxicity is dose-dependent. About 5% of patients who receive  $>550$  mg/m<sup>2</sup> of doxorubicin develop congestive heart failure (CHF). Rates are higher in those with other cardiac risk factors and those who have received mediastinal irradiation. Unfortunately, anthracycline-related CHF is typically not reversible. Intracellular chelators or liposomal formulations of the chemotherapy may prevent cardiotoxicity, but their impact on cure rates is unclear. Radiation has both acute and chronic effects on the heart. It may result in acute and chronic pericarditis, myocardial fibrosis, and accelerated atherosclerosis. The mean time to onset of "acute" pericarditis is 9 months after treatment, and so caretakers must be vigilant. Similarly, chronic pericarditis may manifest years later.

26. The answer is C.

(Chap. 20) Low-molecular-weight heparins (LMWHs) are cleared renally, and these drugs have been described as causing significant bleeding in patients on hemodialysis. They should not be used in patients with dialysis-dependent renal failure. They are class B drugs for pregnancy and dosage is weight-based. Their utility is not affected by diabetes mellitus or hepatic dysfunction. Thrombocytopenia is a rare side effect of both unfractionated heparin and LMWH, but LMWH should not be used in someone with a documented history of heparin-induced thrombocytopenia.

27. The answer is D.

(Chap. 52) The focus of cancer care is cure. Many individuals who are fortunate enough to survive the malignancy nevertheless bear chronic stigmata, both psychological and medical, of the treatment. Anthracyclines, which are used frequently in the treatment of breast cancer, Hodgkin's disease, lymphoma, and leukemia, are toxic to the myocardium and, at high doses, can lead to heart failure. Bleomycin results in pulmonary toxicity. Pulmonary fibrosis and pulmonary venoocclusive disease may result. Liver dysfunction is common with a number of chemotherapy agents. However, cisplatin primarily causes renal toxicity and acute renal failure. It may also cause neuropathy and hearing loss, but liver dysfunction is not a common complication. Ifosfamide may cause significant neurologic toxicity and renal failure. Also, it may cause a proximal tubular defect resembling Fanconi's syndrome. Cyclophosphamide may result in cystitis and increases the long-term risk of bladder cancer. Administration of mesna ameliorates but does not completely eliminate this risk.

28. The answer is B.

(Chap. 22) The most likely diagnosis in this patient is heparin-induced thrombocytopenia (HIT), and heparin should be stopped immediately while continuing anticoagulation with the direct thrombin inhibitor, argatroban. HIT should be suspected in individuals with a fall in platelet count by  $>50\%$  of pretreatment levels. Usually the

fall in platelet counts occurs 5–13 days after starting heparin, but it can occur earlier if there is a prior exposure to heparin, which this patient undoubtedly has because of his mechanical mitral valve replacement. Although a platelet count of  $<100,000/\mu\text{L}$  is highly suggestive of HIT, in most individuals, the platelet count rarely falls this low. HIT is caused by IgG antibodies directed against antigens on PF4 that are exposed when heparin binds to this protein. The IgG antibody binds simultaneously to the heparin–PF4 complex and the Fc receptor on platelet surface and causes platelet activation, resulting in a hypercoagulable state. Individuals with HIT are at increased risk of both arterial and venous thromboses, although venous thromboses are much more common. Demonstration of antibodies directed against the heparin–platelet factor complex is suggestive of, but not sufficient for, diagnosis because these antibodies may be present in the absence of clinical HIT. The serotonin release assay is the most specific test for determining if HIT is present. This assay determines the amount of serotonin released when washed platelets are exposed to patient serum and varying concentrations of heparin. In the cases of HIT, addition of patient serum to the test causes platelet activation and serotonin release due to the presence of heparin–PF4 antibodies. However, treatment of HIT should not be delayed until definitive diagnosis because there is a high risk of thrombotic events if heparin is continued. The risk of thrombotic events due to HIT is increased for  $\sim 1$  month after heparin is discontinued. Thus all patients with HIT should be continued on anticoagulation until the risk of thrombosis is decreased, regardless of whether there is additional need of ongoing anticoagulation. Patients should not be switched to low-molecular-weight heparin (LMWH). Although the incidence of HIT is lower with LMWH, there is cross-reactivity with heparin–PF4 antibodies, and thrombosis can occur. Choice of anticoagulation should be with either a direct thrombin inhibitor or a factor Xa inhibitor. The direct thrombin inhibitors include lepirudin, argatroban, and bivalirudin. In this patient, argatroban is the appropriate choice because the patient has developed acute renal failure in association with contrast dye administration for the cardiac catheterization. Argatroban is hepatically metabolized and is safe to give in renal failure, whereas lepirudin is renally metabolized. Dosage of lepirudin in renal failure is unpredictable, and lepirudin should not be used in this setting. The factor Xa inhibitors, fondaparinux or danaparoid, are also possible treatments for HIT, but due to renal metabolism, they are also contraindicated in this patient. Finally, warfarin is contraindicated as sole treatment for HIT because the fall in vitamin K–dependent anticoagulant factors, especially factor C, can further increase risk of thrombosis and trigger skin necrosis.

29. The answer is C.

(Chap. 5) This patient presents with signs and symptoms of eosinophilia–myalgia syndrome, which is triggered by

ingestion of contaminants in L-tryptophan-containing products. This is a multisystem disease that can present acutely and can be fatal. The two clinical hallmarks are marked eosinophilia and myalgias without any obvious etiology. Eosinophilic fasciitis, pneumonitis, and myocarditis may be present. Typical eosinophil counts are  $>1000/\mu\text{L}$ . Treatment includes withdrawal of all L-tryptophan-containing products and administration of glucocorticoids. Lactose intolerance is very common and typically presents with diarrhea and gas pains temporally related to ingestion of lactose-containing foods. Although systemic lupus erythematosus can present in myriad ways, eosinophilia and myalgias are atypical of this illness. Celiac disease, also known as gluten-sensitive enteropathy, is characterized by malabsorption and weight loss and can present with non-GI symptoms; these classically include arthritis and central nervous system disturbance. This case would not be compatible with celiac disease.

30. The answer is B.

(Chap. 26) The American Cancer Society recommends yearly Pap testing beginning at age 21 or 3 years after first intercourse. The United States Preventive Services Task Force (USPSTF) recommends Pap testing every 1–3 years for women ages 18–65. At age 30, women who have had 3 successive years of normal test results may extend the screening interval to 2–3 years. An upper age limit at which screening ceases to be effective is unknown; however, women  $>70$  years may choose to stop testing if they have had normal Pap smears for the previous 10 years. Women who have no cervical remnant (i.e., with total hysterectomy) do not require Pap smear testing. Current recommendations advise continued Pap screening even after receiving HPV vaccination given that the vaccine does not protect against all forms of human papilloma virus that cause cervical cancer. The vaccine protects against the strains that cause  $\sim 70\%$  of the cervical cancers.

31. The answer is F.

(Chap. 15) Viscosity testing is typically reserved for cases of multiple myeloma where paraproteins (particularly IgM) can lead to vascular sludging and subsequent tissue ischemia. ALL can lead to end-organ abnormalities in kidney and liver; therefore routine chemistry tests are indicated. A lumbar puncture must be performed in cases of newly diagnosed ALL to rule out spread of disease to the central nervous system. Bone marrow biopsy reveals the degree of marrow infiltration and is often necessary for classification of the tumor. Immunologic cell-surface marker testing often identifies the cell lineage involved and the type of tumor, information that is often impossible to discern from morphologic interpretation alone. Cytogenetic testing provides key prognostic information on the disease natural history.



32. The answer is A.

(Chap. 26) Lead-time bias, length-time bias, selection bias, overdiagnosis bias, and avoidance bias can make a screening test appear to improve outcomes when it does not. When lead-time bias occurs, survival appears increased, but life is not truly prolonged. The test only lengthens the time that the patient, the physician, or the investigator is aware of the disease. When length-time bias occurs, aggressive cancers are not detected during screening, presumably due to the higher mortality from these cancers and the length of the screening interval. Selection bias can occur when the test population is either healthier or at higher risk for developing the condition than the general public. Overdiagnosis bias, such as with some indolent forms of prostate cancer, detects conditions that will never cause significant mortality or morbidity during a person's lifetime. The goal of screening is to detect disease at an earlier and more curable stage.

33. The answer is C.

(Chaps. 19 and 20) Lupus anticoagulants cause prolongation of coagulation tests by binding to phospholipids. Although most often encountered in patients with SLE, they may develop in normal individuals. The diagnosis is first suggested by prolongation of coagulation tests. Failure to correct with incubation with normal plasma confirms the presence of a circulating inhibitor. Contrary to the name, patients with LA activity have normal hemostasis and are not predisposed to bleeding. Instead, they are at risk for venous and arterial thromboembolisms. Patients with a history of recurrent unplanned abortions or thrombosis should undergo lifelong anticoagulation. The presence of lupus anticoagulants or anticardiolipin antibodies without a history of thrombosis may be observed because many of these patients will not go on to develop a thrombotic event.

34. The answer is A.

(Chaps. 19 and 20) Factor V Leiden refers to a point mutation in the factor V gene (arginine to glutamine at position 506). This makes the molecule resistant to degradation by activated protein C. This disorder alone may account for up to 25% of inherited prothrombotic states, making it the most common of these disorders. Heterozygosity for this mutation increases an individual's lifetime risk of venous thromboembolism sevenfold. A homozygote has a 20-fold increased risk of thrombosis. Prothrombin gene mutation is probably the second most common condition that causes "hypercoagulability." Antithrombin, protein C, and protein S deficiencies are more rare. Antithrombin complexes with activated coagulation proteins and blocks their biologic activity. Deficiency in antithrombin therefore promotes prolonged activity of coagulation proteins, resulting in thrombosis. Similarly, protein C and protein S are involved in the proteolysis of factors Va and VIIIa, which shuts off fibrin

formation. Because proteins C and S depend on vitamin K for carboxylation, administration of warfarin anticoagulants may lower the level of proteins C and S more quickly relative to factors II, VII, IX, and X, thereby promoting coagulation. Patients with protein C deficiency may develop warfarin-related skin necrosis.

35. The answer is E.

(Chap. 22) Low-molecular-weight heparins have become widely used in the management of uncomplicated DVT and pulmonary embolus due to their ease of administration and predictable anticoagulant effects. LMWH is derived from unfractionated heparin by chemical or enzymatic depolymerization that results in smaller fragments of heparin, weighing approximately a third the mean molecular mass of unfractionated heparin. The mechanism of action of the LMWH is different from that of heparin in that the anticoagulant effect of LMWH is related to its ability to potentiate factor Xa inhibition via activating antithrombin. Although heparin does have the ability to potentiate factor Xa, heparin primarily acts as a cofactor to activate antithrombin and binding antithrombin to thrombin. To activate antithrombin, an 18-unit polysaccharide chain is required. With a mean molecular mass of 5000 kD, the average pentasaccharide chain of LMWH is only 17 units, and thus over half the LMWH molecules lack the ability to bridge antithrombin to thrombin. A further difference between LMWH and unfractionated heparin is that LMWH is less bound to proteins in plasma, resulting in >90% bioavailability after SC injection. Thus LMWHs have a more predictable anticoagulant response and a longer half-life. Because of the pharmacokinetics of LMWH, most individuals do not require monitoring of factor Xa levels to ensure adequate anticoagulation, allowing for outpatient treatment of uncomplicated DVT and pulmonary embolus. When outcomes are compared with heparin, LMWHs are equally effective for treatment, but there is substantial health care savings when outpatient treatment is used. Furthermore, studies have demonstrated that serious bleeding events are less likely to occur with LMWH than with unfractionated heparin. Thrombocytopenia is also less likely to occur with LMWH compared to unfractionated heparin. A meta-analysis of 5275 patients on 13 studies suggested that the rates of thrombocytopenia in patients on unfractionated heparin and LMWH may actually be similar (Morris *et al.*, 2007). Caution should be taken, however, when using LMWH in individuals who are obese, pregnant, or have renal insufficiency. In these instances, monitoring of factor Xa levels is required to ensure adequacy of dosing without evidence of drug accumulation.

36. The answer is B.

(Chap. 22) The patient has evidence of thrombotic thrombocytopenic purpura (TTP) from clopidogrel

manifested as altered mental status, fever, acute renal failure, thrombocytopenia, and microangiopathic hemolytic anemia. The peripheral blood smear show anisocytosis with schistocytes and platelet clumping consistent with this disease. Clopidogrel is a thienopyridine antiplatelet agent that is known to be associated with life-threatening hematologic effects, including neutropenia, TTP, and aplastic anemia. The true incidence of TTP associated with thienopyridine use is unknown, but it occurs with both clopidogrel and ticlopidine use. When compared to ticlopidine, TTP associated with clopidogrel use occurs earlier (often within 2 weeks) and tends to be less responsive to therapy with plasmapheresis. In addition, individuals with TTP associated with clopidogrel generally have a higher platelet count and creatinine and their TTP is less likely to be associated with ADAMTS13 deficiency, a von Willebrand's factor-cleaving protease implicated in the pathogenesis of idiopathic TTP. The mortality of TTP associated with thienopyridines is ~25–30%.

37. The answer is B.

(Chap. 42) Metastatic tumors of bone are more common than primary bone tumors. Prostate, breast, and lung primaries account for 80% of all bone metastases. Tumors from the kidney, bladder, and thyroid and lymphomas and sarcomas also commonly metastasize to bone. Metastases usually spread hematogenously. In decreasing order, the most common sites of bone metastases include vertebrae, proximal femur, pelvis, ribs, sternum, proximal humerus, and skull. Pain is the most common symptom. Hypercalcemia may occur with bone destruction. Lesions may be osteolytic, osteoblastic, or both. Osteoblastic lesions are associated with a higher level of alkaline phosphatase.

38. The answer is D.

(Chap. 10) Each of the listed diagnoses has a rather characteristic set of laboratory findings that are virtually diagnostic for the disease once the disease has progressed to a severe stage. Both HUS and TTP cause hemolysis and thrombocytopenia, as well as fevers. Cerebrovascular events and mental status change occur more commonly in TTP, and renal failure is more common in HUS. Severe leptospirosis, or Weil's disease, is notable for fevers, hyperbilirubinemia, and renal failure. Conjunctival suffusion is another helpful clue. Acute promyelocytic leukemia is notable for anemia, thrombocytopenia, and either elevated or decreased white blood cell count, all in the presence of disseminated intravascular coagulation. PNH is a rare disorder characterized by hemolytic anemia (particularly at night), venous thrombosis, and deficient hematopoiesis. It is a stem cell-derived intracorpuseular defect. Anemia is usually moderate in severity, and there is often concomitant granulocytopenia and thrombocytopenia. Venous thrombosis occurs much more commonly than in the population at large. The

intraabdominal veins are often involved, and patients may present with Budd-Chiari syndrome. Cerebral sinus thrombosis is a common cause of death in patients with PNH. The presence of pancytopenia and hemolysis should raise suspicion for this diagnosis, even before the development of a venous thrombosis. In the past PNH was diagnosed by abnormalities on the Ham or sucrose lysis test; however, currently flow cytometry analysis of glycosylphosphatidylinositol (GPI) linked proteins (such as CD55 and CD59) on red blood cells and granulocytes is recommended.

39. The answer is A.

(Chap. 13) Chronic idiopathic myelofibrosis (IMF) is the least common myeloproliferative disorder and considered a diagnosis of exclusion after other causes of myelofibrosis have been ruled out. The typical patient with IMF presents in the sixth decade, and the disorder is asymptomatic in many patients. Fevers, fatigue, night sweats, and weight loss may occur in IMF, whereas these symptoms are rare in other myeloproliferative disorders. However, no signs or symptoms are specific for the diagnosis of IMF. Often marked splenomegaly is present and may extend across the midline and to the pelvic brim. A peripheral blood smear demonstrates the typical findings of myelofibrosis including teardrop-shaped red blood cells, nucleated red blood cells, myelocytes, and metamyelocytes that are indicative of extramedullary hematopoiesis. Anemia is usually mild, and platelet and leukocyte counts are often normal. Bone marrow aspirate is frequently unsuccessful because the extent of marrow fibrosis makes aspiration impossible. When a bone marrow biopsy is performed, it demonstrates hypercellular marrow with trilineage hyperplasia and increased number of megakaryocytes with large dysplastic nuclei. Interestingly, individuals with IMF often have associated autoantibodies, including rheumatoid factor, antinuclear antibodies, or a positive Coombs tests. To diagnose someone as having IMF, it must be shown that they do not have another myeloproliferative disorder or hematologic malignancy that is the cause of myelofibrosis. The most common disorders that present in a similar fashion to IMF are polycythemia vera and chronic myelogenous leukemia. Other nonmalignant disorders that can cause myelofibrosis include HIV infection, hyperparathyroidism, renal osteodystrophy, systemic lupus erythematosus, tuberculosis, and marrow replacement in other cancers such as prostate or breast cancer. In the patient described here, there is no other identifiable cause of myelofibrosis; thus chronic idiopathic myelofibrosis can be diagnosed.

40. The answer is E.

(Chaps. 49 and 51) Although it once was thought that most cases of hypercalcemia of malignancy are due to a direct resorption of bone by the tumor, it is now recognized that

80% of such instances occur because of the production of a protein called parathyroid hormone reactive protein (PTHrP) by the tumor. PTHrP shares 80% homology in the first 13 terminal amino acids with native parathyroid hormone. The aberrantly produced molecule is essentially functionally identical to native parathyroid hormone in that it causes renal calcium conservation, osteoclast activation and bone resorption, renal phosphate wasting, and increased levels of urinary cyclic adenosine monophosphate (cAMP). Only ~20% of cases of the hypercalcemia of malignancy are due to local production of substances, such as transforming growth factor and IL-1 or IL-6, which cause bone resorption at the local level and release of calcium from bony stores. Although aggressive hydration with saline and administration of a loop diuretic are helpful in the short-term management of patients with the hypercalcemia of malignancy, the most important therapy is the administration of a bisphosphonate, such as pamidronate, that will control the laboratory abnormalities and the associated symptoms in the vast majority of these patients. Symptoms of hypercalcemia are nonspecific and include fatigue, lethargy, polyuria, nausea, vomiting, and decreased mental acuity.

41. The answer is A.

(Chap. 5) Under normal or nonstress conditions, roughly 90% of the neutrophil pool is in the bone marrow, 2–3% in the circulation, and the remainder in the tissues. The circulating pool includes the freely flowing cells in the bloodstream, and the others are marginated in close proximity to the endothelium. Most of the marginated pool is in the lung, which has a vascular endothelium surface area. Margination in the postcapillary venules is mediated by selectins that cause a low-affinity neutrophil–endothelial cell interaction that mediates “rolling” of the neutrophils along the endothelium. A variety of signals including interleukin 1, tumor necrosis factor  $\alpha$ , and other chemokines can cause leukocytes to proliferate and leave the marrow and enter the circulation. Neutrophil integrins mediate the stickiness of neutrophils to endothelium and are important for chemokine-induced cell activation. Infection causes a marked increase in bone marrow production of neutrophils that marginate and enter tissue. Acute glucocorticoids increase neutrophil count by mobilizing cells from the bone marrow and marginated pool.

42. The answer is A.

(Chap. 10) Haptoglobin is an  $\alpha$  globulin normally present in serum. It binds specifically to the globin portion of hemoglobin, and the complex is cleared by the mononuclear cell phagocytosis. Haptoglobin is reduced in all hemolytic anemias as it binds free hemoglobin. It can also be reduced in cirrhosis and so is not diagnostic of hemolysis outside of the correct clinical context. Assuming a normal marrow and iron stores, the reticulocyte count

will be elevated as well to try to compensate for the increased red cell destruction of hemolysis. Release of intracellular contents from the red cell (including hemoglobin and LDH) induces heme metabolism, producing unconjugated bilirubinemia. If the haptoglobin system is overwhelmed, the kidney will filter free hemoglobin and reabsorb it in the proximal tubule for storage of iron by ferritin and hemosiderin. Hemosiderin in the urine is a marker of filtered hemoglobin by the kidneys. In massive hemolysis, free hemoglobin may be excreted in urine.

43. The answer is B.

(Chap. 22) Antiplatelet and anticoagulant agents act by a variety of mechanisms. Platelet aggregation is dependent initially on the binding of von Willebrand’s factor and platelet glycoprotein IB. This initiates the release of a variety of molecules, including thromboxane  $A_2$  and adenosine diphosphate (ADP), resulting in platelet aggregation. Glycoprotein IIB/IIIa receptors recognize the amino acid sequence that is present in adhesive proteins such as fibrinogen. Coagulation occurs by a convergence of different pathways on the prothrombinase complex, which mediates the conversion of fibrinogen to fibrin, thus forming the clot. Factor Xa and factor Va are two of the essential components of the prothrombinase complex. Abciximab is a monoclonal antibody of human and murine protein that binds to GpIIb/IIIa. It and other inhibitors have been studied extensively in patients with unstable angina, patients with MI, and those undergoing percutaneous coronary intervention. Clopidogrel acts by inhibiting ADP-induced platelet aggregation. It has been evaluated in many of the same settings either in place of or in conjunction with aspirin. Heparin acts to bind factor Xa and activate antithrombin. Low-molecular-weight heparins primarily act through anti-factor Xa activity. Fondaparinux is a synthetic pentasaccharide that causes selective indirect inhibition of factor Xa. Lepirudin and argatroban are direct thrombin inhibitors. They are indicated in patients with heparin-induced thrombocytopenia. Warfarin acts by inhibiting vitamin K-dependent carboxylation of factors II, VII, IX, and X.

44. The answer is E.

(Chap. 29) In addition to chronic GVHD, there are late complications of bone marrow transplantation that result from the chemotherapy and radiotherapy preparative regimen. Children may experience decreased growth velocity and delay in the development of secondary sex characteristics. Hormone replacement may be necessary. Gonadal dysfunction is common. Men frequently become azoospermic, and women develop ovarian failure. Patients who receive total body irradiation are at risk for cataract formation and thyroid dysfunction. Although cognitive dysfunction may occur in the peri-transplant period for many reasons, there is no definitive evidence that dementia occurs at an increased frequency.

45. The answer is E.

(Chap. 22) Clopidogrel and ticlopidine are the two currently available members of the thienopyridine class of antiplatelet agents. As demonstrated in the figure, the mechanism of action of these agents is to prevent ADP-induced platelet aggregation by irreversibly inhibiting the P2Y<sub>12</sub> receptor. Both agents are prodrugs that require hepatic activation by the cytochrome P450 system; in the usual dose they require several days to reach maximal effectiveness. Clopidogrel is a more potent agent than ticlopidine with fewer associated side effects, and thus it has replaced ticlopidine in clinical practice.

Other antiplatelet drugs act at other sites in the cascade that leads to platelet aggregation. Aspirin is the most commonly used antiplatelet agent. At the usual doses, aspirin inhibits COX-1 to prevent the production of thromboxane A<sub>2</sub>, a potent platelet agonist. Dipyridamole is a weak platelet inhibitor alone and acts as a phosphodiesterase inhibitor. In addition, dipyridamole blocks the uptake of adenosine by platelets. When combined with aspirin, dipyridamole has been shown to decrease the risk of stroke, but because it acts as a vasodilator, there is concern that it might increase the risk of cardiac events in severe coronary artery disease. A final class of antiplatelet agents is the glycoprotein IIb/IIIa inhibitors, which include abciximab, eptifibatide, and tirofiban. Each of these agents has a slightly different site of action, but all decrease the ability of platelets to bind adhesive molecules such as fibrinogen and von Willebrand's factor. Thus these agents decrease platelet aggregation. Abciximab is a monoclonal antibody directed against the activated form of GPIIb/IIIa. Tirofiban and eptifibatide are small synthetic molecules that bind to various sites of the GPIIb/IIIa receptor to decrease platelet aggregation. (See Fig. 22-3.)

46. The answer is C.

(Chap. 14) This patient presents with typical findings of chronic myelogenous leukemia (CML) which has an incidence of 1.5 per 100,000 people yearly. The typical age of onset is in the mid-forties and there is a slight male predominance. Half of individuals are asymptomatic at the time of diagnosis. If symptoms are present, they are typically nonspecific and include fatigue and weight loss. Occasionally patients have symptoms related to splenic enlargement such as early satiety and left upper quadrant pain. Laboratory findings are suggestive of CML. A high leukocyte count of 100,000/ $\mu$ L is typical, with a predominant granulocytic differential, including neutrophils, myelocytes, metamyelocytes, and band forms. The circulating blast count should be <5%. Anemia and thrombocytosis are also common. The bone marrow demonstrates nonspecific increase in cellularity with an increase in the myeloid-to-erythroid ratio. The definitive diagnosis of CML is usually made by demonstrating the presence of the Philadelphia chromosome, a

reciprocal translocation between chromosomes 9 and 22. This cytogenetic abnormality is present in 90–95% of individuals with CML and can be found by fluorescent in situ hybridization (FISH) or by cytogenetics. This translocation results in the fusion of the *bcr* gene with the *abl* gene. The *bcr-abl* fusion protein results in constitutive activation of *abl* tyrosine kinase enzyme that prevents apoptosis and leads to increased survival of the cells containing the mutation. Ultimately, untreated CML develops into an accelerated phase with increasing numbers of mutations and leads to acute blast crisis. The deletion of the long arm of chromosome 5 is present in some acute myeloid leukemias and associated with older age at diagnosis. The inversion of chromosome 16 is typically present in acute myelomonocytic leukemia (M4 subtype). The translocation of the long arms of chromosomes 15 and 17 is the mutation associated with acute promyelocytic anemia that results in arrest of cellular differentiation that can be treated with pharmacologic doses of ATRA. Finally, trisomy 12 is one of several mutations that may result in the development of chronic lymphocytic leukemia.

47. The answer is D.

(Chap. 40) Testicular cancer occurs most commonly in the second and third decades of life. The treatment depends on the underlying pathology and the stage of the disease. Germ cell tumors are divided into seminomatous and nonseminomatous subtypes. Although the pathology of this patient's tumor was seminoma, the presence of AFP is suggestive of occult nonseminomatous components. If there are any nonseminomatous components, the treatment follows that of a nonseminomatous germ cell tumor. This patient therefore has a clinical stage I nonseminomatous germ cell tumor. As his AFP returned to normal after orchiectomy, there is no obvious occult disease. However, between 20% and 50% of these patients have disease in the retroperitoneal lymph nodes. Because numerous trials have indicated no survival difference in this cohort between observation and RPLND and because of the potential side effects of RPLND, either approach is reasonable. Radiation therapy is the appropriate choice for stage I and stage II seminoma. It has no role in nonseminomatous lesions. Adjuvant chemotherapy is not indicated in early-stage testicular cancer. Hormonal therapy is effective for prostate cancer and receptor-positive breast cancer but has no role in testicular cancer. PET scan has no currently defined clinical role.

48. The answer is C.

(Chap. 26) Tobacco use is the most modifiable risk factor for cardiovascular disease, respiratory disease, and cancer. Smokers have a 33% lifetime chance of dying from a smoking-related cause. Although tobacco is associated with more cardiovascular deaths than cancer deaths, it is

associated with malignancies in the mouth, lung, esophagus, kidney, bladder, pancreas, and stomach. The degree of smoke exposure as well as the degree of inhalation is correlated with risk of lung cancer mortality. Smokeless tobacco is the fastest growing part of the tobacco industry and carries with it a substantial risk for dental and gingival disease as well as oral and esophageal cancers. Most American smokers begin <18 years of age. The COMMIT trial showed that a cessation message and cessation programs were effective for light tobacco smokers, whereas heavy smokers were more likely to need counseling, behavioral strategies, or pharmacologic adjuncts. Most Americans who quit smoking cigarettes, however, do so without involvement in a cessation program.

49. The answer is B.

(Chap. 44) The patient is a young man with asymmetric hilar adenopathy. The differential diagnosis would include lymphoma, testicular cancer, and, less likely, tuberculosis or histoplasmosis. Because of his young age, testicular examination and ultrasonography would be indicated, as would measurement of  $\beta$ -hCG and AFP, which are generally markedly elevated. In men with carcinoma of unknown primary source, AFP and  $\beta$ -hCG should be checked because the presence of testicular cancer portends an improved prognosis compared with possible primary sources. Biopsy would show lymphoma. The ACE level may be elevated but is not diagnostic of sarcoidosis. Thyroid disorders are not likely to present with unilateral hilar adenopathy. Finally, PSA is not indicated in this age category, and C-reactive protein would not differentiate any of the disorders just mentioned. Biopsy is the most important diagnostic procedure.

50. The answer is A.

(Chap. 33) Approximately 20% of all lung cancers are small cell cancers. These tumors tend to present centrally, be derived from neuroendocrine tissues, and be much more chemo- and radiosensitive than non-small cell cancer. Histologic subtypes of non-small cell cancer include adenocarcinoma (which has a more often peripheral presentation), large cell cancer, bronchoalveolar cell cancer, and squamous cell (or bronchogenic) lung cancer. All histologic types of lung cancer are associated with smoking. In the relatively uncommon patient who presents with a small non-small cell primary lesion and no lymph node involvement, surgery alone may be curative. Patients with small cell lung cancer are divided into two staging groups: those with limited disease who have tumors generally confined to one hemithorax encompassable by a single radiation port and all others who are said to have extensive disease. About 20 percent of patients who present with limited-stage small cell lung cancer are curable with a combination of radiation therapy and chemotherapy, with cisplatin and etoposide the two most active agents.

51. The answer is D.

(Chap. 35) In the United States, esophageal cancers are either squamous cell carcinomas or adenocarcinomas. Esophageal cancer is a deadly cancer with a very high mortality rate, regardless of cell type. This is because diagnosis is usually made well after patients develop symptoms, meaning that the mass is often large with frequent spread to the mediastinum and paraaortic lymph nodes by the time that endoscopy is considered for diagnosis. Smoking and alcohol consumption are synergistic risks for squamous cell carcinoma, not adenocarcinoma. Other risks for squamous cell carcinoma include nitrites, smoked opiates, mucosal injury (including ingestion of hot tea), and achalasia. The major risk for adenocarcinoma is chronic gastric reflux, gastric metaplasia of the esophagus (Barrett's esophagus). These adenocarcinomas account for 60% of esophageal carcinomas and behave like gastric carcinomas. In recent years, the incidence of squamous carcinoma of the esophagus has declined while the incidence of adenocarcinoma has increased, particularly in white men. Approximately 10% of esophageal carcinomas arise in the upper third, 35% in the middle third, and 55% in the lower third. Fewer than 5% of patients with esophageal carcinoma survive 5 years. There is no consistent advantage of one cell type over another. Surgery, radiation therapy, and chemotherapy are all options, but usually these interventions are palliative.

52. The answer is E.

(Chap. 23) A small proportion of cancers occur in patients with a genetic predisposition. Roughly 100 syndromes of familial cancer have been reported. Recognition allows for genetic counseling and increased cancer surveillance. Down's syndrome, or trisomy 21, is characterized clinically by a variety of features, including moderate to severe learning disability, facial and musculoskeletal deformities, duodenal atresia, congenital heart defects, and an increased risk of acute leukemia. Fanconi's anemia is a condition associated with defects in DNA repair. There is a higher incidence of cancer, with leukemia and myelodysplasia the most common. Von Hippel-Lindau syndrome is associated with hemangioblastomas, renal cysts, pancreatic cysts and carcinomas, and renal cell cancer. Neurofibromatosis (NF) type I and type II are both associated with increased tumor formation. NF II is more associated with a schwannoma. Both carry a risk of malignant peripheral nerve sheath tumors. Fragile X is a condition associated with chromosomal instability of the X chromosome. These patients have mental retardation, typical morphologic features including macroorchidism and prognathia, behavioral problems, and occasionally seizures. Increased cancer incidence has not been described.

53. The answer is E.

(Chap. 13) Thrombocytosis may be "primary" or "secondary." Essential thrombocytosis is a myeloproliferative

disorder that involves a multipotent hematopoietic progenitor cell. Unfortunately, there is no clonal marker that can reliably distinguish it from more common non-clonal, reactive forms of thrombocytosis. Therefore, the diagnosis is one of exclusion. Common causes of secondary thrombocytosis include infection, inflammatory conditions, malignancy, iron deficiency, hemorrhage, and postsurgical states. Other myeloproliferative disorders, such as CML and myelofibrosis, may result in thrombocytosis. Similarly, myelodysplastic syndromes, particularly the 5q-syndrome, may cause thrombocytosis. Pernicious anemia caused by vitamin B<sub>12</sub> deficiency does not typically cause thrombocytosis. However, correction of B<sub>12</sub> deficiency or folate deficiency may cause a “rebound” thrombocytosis. Similarly, cessation of chronic ethanol use may also cause a rebound thrombocytosis.

54. The answer is A.

(Chap. 20) D-Dimer is a degradation product of cross-linked fibrin and is elevated in conditions of ongoing thrombosis. Low concentrations of D-dimer are considered to indicate the absence of thrombosis. Patients >70 years of age frequently have elevated D-dimers in the absence of thrombosis, making this test less predictive of acute disease. Clinical symptoms are often not present in patients with DVT and do not affect interpretation of a D-dimer. Tobacco use, although frequently considered a risk factor for DVT, and previous DVT should not affect the predictive value of D-dimer. Homan's sign, calf pain elicited by dorsiflexion of the foot, is not predictive of DVT and is unrelated to D-dimer.

55. The answer is E.

(Chap. 5) Many drugs can lead to neutropenia, most commonly via retarding neutrophil production in the bone marrow. Of the list above, trimethoprim-sulfamethoxazole is the most likely culprit. Other common causes of drug-induced neutropenia include alkylating agents such as cyclophosphamide or busulfan, antimetabolites including methotrexate and 5-fluorouracil, penicillin and sulfonamide antibiotics, antithyroid drugs, antipsychotics, and anti-inflammatory agents. Prednisone, when used systemically, often causes an increase in the circulating neutrophil count because it leads to demargination of neutrophils and bone marrow stimulation. Ranitidine, an H<sub>2</sub> blocker, is a well-described cause of thrombocytopenia but has not been implicated in neutropenia. Efavirenz is a non-nucleoside reverse transcriptase inhibitor whose main side effects include a morbilliform rash and central nervous system effects including strange dreams and confusion. The presence of these symptoms does not require drug cessation. Darunavir is a new protease inhibitor that is well tolerated. Common side effects include a maculopapular rash and lipodystrophy, a class effect for all protease inhibitors.

56. The answer is E.

(Chap. 35) Although esophageal masses and cancer can lead to several types of dysphagia, the most common complaint is solid food dysphagia that worsens to the point that liquids are also hard to swallow. Such a complaint warrants upper endoscopy, particularly if the patient falls in a high-risk group for esophageal cancer, with careful examination of the stomach, trachea, and larynx. Odynophagia with chest pain is more reminiscent of ulcerative disease of the esophagus due to either infection, such as cytomegalovirus or *Candida*, or pill esophagitis. Spasm causes severe pain as well, but this may occur independent of swallowing. Liquid phase dysphagia often implies a functional disorder of the esophagus rather than a mass-like obstruction. A barium swallowing study or cine-esophagram in conjunction with a thorough history and physical examination may prove diagnostic. Oropharyngeal dysphagia usually localizes disease quite specifically to the oropharynx. Early satiety is often due to gastric obstruction or extrinsic compression of the stomach (splenomegaly is a common reason for this), or to a functional gastric disorder such as gastroparesis.

57. The answer is C.

(Chap. 15) Hepatitis B and C are both common causes of cirrhosis and are strongly associated with the development of hepatocellular carcinoma. Hepatitis C, but not hepatitis B, can also lead to a lymphoplasmacytic lymphoma, often in the spleen, that resolves with cure of hepatitis C. Other infections are commonly implicated as causes of lymphoma. Epstein-Barr virus has been associated with a large number of lymphoid malignancies including posttransplant lymphoproliferative disease (PTLD), Hodgkin's disease, central nervous system lymphoma, and Burkitt's lymphoma. *H. pylori* is necessary and sufficient for gastric mucosa-associated lymphoid tissue lymphoma development, and cure can be achieved with eradication of the organism in some cases. HHV8 is a known cause of body cavity lymphoma, including primary pleural lymphoma. Celiac sprue has been associated with gastrointestinal tract lymphoma. Many collagen vascular diseases and their treatments (tumor necrosis factor  $\alpha$  inhibitors) have also been associated with lymphomas, as have acquired and inherited immunodeficiencies.

58. The answer is D.

(Chaps. 11 and 13) Chronic idiopathic myelofibrosis is a clonal disorder of a multipotent hematopoietic progenitor cell of unknown etiology that is characterized by marrow fibrosis, myeloid metaplasia, extramedullary hematopoiesis, and splenomegaly. The peripheral blood smear reflects the features of extramedullary hematopoiesis, with teardrop-shaped red cells, immature myeloid cells, and abnormal platelets. Leukocytes and platelets may both be elevated.

The median survival is poor at only 5 years. These patients eventually succumb to increasing organomegaly, infection, and possible transformation to acute leukemia. There is no specific therapy for chronic idiopathic myelobrosis. Erythropoietin has not been shown to be consistently effective and may exacerbate splenomegaly. Supportive care with red blood cell transfusions is necessary as anemia worsens. Chemotherapy has no role in changing the natural history of the disease. Some newer agents, such as interferon and thalidomide, may play a role, but their place is not clear. Splenectomy may be necessary in symptomatic patients with massive splenomegaly. However, extramedullary hematopoiesis may worsen with rebound thrombocytosis and compensatory hepatomegaly. The only potential curative modality is allogeneic bone marrow transplantation. Morbidity and mortality are high, particularly in older patients. In light of this patient's young age and the presence of three healthy siblings, HLA matching of her siblings is the most reasonable step.

59. The answer is D.

(Chap. 7) Iron-deficiency anemia is a condition in which there is anemia and clear evidence of iron deficiency. Initially, a state of negative iron balance occurs during which iron stores become slowly depleted. Serum ferritin may decrease, and the presence of stainable iron on bone marrow preparation decreases. When iron stores are depleted, serum iron begins to fall. TIBC starts to increase, reflecting the presence of circulating unbound transferrin. Once the transferrin saturation falls to 15–20%, hemoglobin synthesis is impaired. The peripheral blood smear reveals the presence of microcytic and hypochromic red cells. Reticulocytes may also become hypochromic. Reticulocyte numbers are reduced relative to the level of anemia, reflecting a hypoproduction anemia secondary to iron deficiency. Clinically, these patients exhibit the usual signs of anemia: fatigue, pallor, and reduced exercise capacity. Cheilosis and koilonychia are signs of advanced tissue iron deficiency. Some patients may experience pica, a desire to ingest certain materials, such as ice (pagophagia) and clay (geophagia).

60. The answer is B.

(Chap. 2) The first step in diagnosing polycythemia vera is to document an elevated red blood cell (RBC) mass. A normal RBC mass suggests spurious polycythemia. Next, serum erythropoietin (EPO) levels should be measured. If EPO levels are low, the diagnosis is polycythemia vera. Confirmatory tests include JAK-2 mutation analysis, leukocytosis, and thrombocytosis. Elevated EPO levels are seen in the normal physiologic response to hypoxia as well as in autonomous production of EPO. Further steps in the workup include evaluation for hypoxia with an arterial blood gas, consideration of smoker's polycythemia (elevated carboxyhemoglobin

levels), and disorders of increased hemoglobin affinity for oxygen. Low serum EPO levels with low oxygen saturation suggest inadequate renal production (renal failure). High RBC mass and high EPO levels with normal oxygen saturation may be seen with autonomous EPO production, such as in renal cell carcinoma.

61. The answer is E.

(Chap. 10) Hemolytic anemias may be classified as intracorpusecular or extracorpusecular. In intracorpusecular disorders, the patient's red blood cells (RBCs) have an abnormally short life span due to an intrinsic RBC factor. In extracorpusecular disorders, the RBC has a short life span due to a nonintrinsic RBC factor. Thrombotic thrombocytopenic purpura (TTP) is an acquired disorder where red cell and platelet destruction occur not because of defects of these cell lines, but rather as a result of microangiopathy leading to destructive shear forces on the cells. Other clinical sign and symptoms include fever, mental status change, and, less commonly, renal impairment. All cases of hemolysis in conjunction with thrombocytopenia should be rapidly ruled out for TTP by evaluation of a peripheral smear for schistocytes because plasmapheresis is lifesaving. Other causes of extravascular hemolytic anemia include hypersplenism, autoimmune hemolytic anemia, disseminated intravascular coagulation, and other microangiopathic hemolytic anemias. The other four disorders listed in the question all refer to some defect of the red blood cell itself that leads to hemolysis. Elliptocytosis is a membranopathy that leads to varying degrees of destruction of the red cell in the reticuloendothelial system. Sick cell anemia is a congenital hemoglobinopathy classified by recurrent pain crises and numerous long-term sequelae due to a well-defined  $\beta$  globin mutation. Pyruvate kinase deficiency is a rare disorder of the glycolytic pathway that causes hemolytic anemia. Paroxysmal nocturnal hemoglobinuria (PNH) is a form of acquired hemolysis due to an intrinsic abnormality of the red cell. It also often causes thrombosis and cytopenias. Bone marrow failure is a feared association with PNH.

62. The answer is C.

(Chap. 22) Heparin-induced thrombocytopenia (HIT) is common in patients who receive heparin products. Because the risk of death is significantly increased in patients with HIT type II and thrombosis if no anticoagulation is given, observation or simply discontinuation of heparin is not an option. Although enoxaparin and other low-molecular-weight heparins have less of a propensity to cause HIT, they are cross-reactive in patients who already have HIT and thus are contraindicated. Direct thrombin inhibitors are the treatment of choice. Lepirudin is a recombinant direct thrombin inhibitor. It may be given intravenously or subcutaneously. It is excreted through the kidney and lacks an

antidote. Therefore, it is relatively contraindicated in patients with renal insufficiency. Argatroban is another direct thrombin inhibitor. Because it is hepatically metabolized, it is a reasonable option in patients with HIT and renal insufficiency.

63. The answer is B.

(Chap. 15) Autoimmune hemolytic anemia and thrombocytopenia are common, and a peripheral blood smear and a Coombs test help evaluate their presence. Hypersplenism is also seen in CLL because the spleen sequesters large numbers of circulating blood cells and enlarges. Hence a careful left upper quadrant examination looking for a palpable splenic tip is the standard of care in this situation. This patient is at risk of hepatic decompensation as well, given his hepatitis C that can also cause anemia and thrombocytopenia. Bone marrow infiltration of tumor cells can lead to cytopenias in CLL. However, this is in effect a diagnosis of exclusion. Once these three possibilities are ruled out, a bone marrow biopsy is a reasonable next step. This initial evaluation before presuming spread of CLL is critical for therapy because each possibility will require different therapy (glucocorticoids or rituximab for hemolysis, hepatology referral for liver failure, and splenectomy for symptomatic hypersplenism).

64. The answer is A.

(Chap. 36) Currently hepatocellular carcinoma can be staged using a variety of staging systems. The TNM system set up by the American Joint Commission for Cancer has been largely replaced by either the Okuda system or the Cancer of the Liver Italian Program (CLIP) system because these systems include the presence of cirrhosis as a part of staging. This patient would have stage II disease by the TNM system because he has a single tumor >2 cm but without evidence of vascular invasion. By the CLIP system, the patient would be classified as CLIP stage I because of the presence of Child-Pugh class B cirrhosis. Primary surgical resection of a solitary mass is reserved for those individuals with stage I or II HCC or CLIP stage 0. However, because of the high rate of liver failure and mortality following surgical resection in individuals with Child-Pugh class B or C cirrhosis, these individuals are not candidates for surgical resection. Orthotopic liver transplantation (OLT) is the treatment of choice in individuals with stage I or II disease and cirrhosis. Individuals can be referred for OLT if there is a single mass <5 cm or three masses <3 cm and no vascular invasion is present. Radiofrequency ablation uses heat to cause necrosis of an ~7-cm zone in a non-specific manner. This technique can be used effectively in single lesions that are 3–4 cm in size. However, tumors located near the main portal pedicles can lead to bile duct injury and obstruction. Percutaneous ethanol injection (not listed) results in necrosis of the injected

area and requires multiple injections. The maximum size of tumor that can be treated with percutaneous ethanol injection is 3 cm. Transarterial chemoembolization is a form of regional chemotherapy in which a variety of chemotherapeutic agents are directly injected into the hepatic artery. Two randomized trials have shown a survival advantage for transarterial chemoembolization in a highly selected subset of patients. The technique is recommended for individuals who are not candidates for orthotopic liver transplantation, including individuals with multiple medical comorbidities, more than four lesions, lymph node metastases, tumors >5 cm, and gross vascular invasion. Systemic chemotherapy has no effect on survival and has a <25% response rate. It is not recommended for most individuals with HCC. Sorafenib is a novel agent that increases median survival from 6 months to 9 months in patients with advanced disease.

65. The answer is A.

(Chap. 35) A strong family history of colon cancer should prompt consideration for hereditary nonpolyposis colon cancer (HNPCC), or Lynch syndrome particularly if diffuse polyposis is *not* noted on colonoscopy. HNPCC is characterized by (1) three or more relatives with histologically proven colorectal cancer, one of whom is a first-degree relative and of the other two, at least one with the diagnosis <50 years of age; and (2) colorectal cancer in at least two generations. The disease is an autosomal dominant trait and associated with other tumors, including in the endometrium and ovary. The proximal colon is most frequently involved, and cancer occurs with a median age of 50 years, 15 years earlier than in sporadic colon cancer. Patients with HNPCC are recommended to receive biennial colonoscopy and pelvic ultrasound beginning at age 25. Innumerable polyps suggest the presence of one of the autosomal dominant polyposis syndromes, many of which carry a high malignant potential. These include familial adenomatous polyposis, Gardner's syndrome (associated with osteomas, fibromas, epidermoid cysts), or Turcot's syndrome (associated with brain cancer). Peutz-Jeghers syndrome is associated with mucocutaneous pigmentation and hamartomas. Tumors may develop in the ovary, breast, pancreas, and endometrium; however, malignant colon cancers are not common. Ulcerative colitis is strongly associated with development of colon cancer, but it is unusual for colon cancer to be the presenting finding in ulcerative colitis. Patients are generally symptomatic from their inflammatory bowel disease long before cancer risk develops.

66. The answer is E.

(Chap. 15) Classical Hodgkin's disease carries a better prognosis than all types of non-Hodgkin's lymphoma. Patients with good prognostic factors can achieve cure with extended field radiation alone; those with higher



risk disease often achieve cure with high-dose chemotherapy and sometimes radiation. The chance of cure is so high (>90%) that many protocols are now considering long-term sequelae of current therapy such as carcinomas, hypothyroidism, premature coronary disease, and constrictive pericarditis in those receiving radiation therapy. Combination chemotherapy with ABVD appears to be the form of treatment with the lowest risk of late fatal complications.

67. The answer is B.

(Chap. 20) Fibrinogen is a 340-kDa dimeric molecule made up of two sets of three covalently linked polypeptide chains. Thrombin cleaves multiple peptides to produce fibrin monomer that factor XIII stabilizes by cross-linking. Although fibrinogen is needed for platelet aggregation and fibrin formation, even severe fibrinogen deficiency such as afibrinogenemia produces mild, rare bleeding episodes, most often after surgery. Dysfibrinogenemia refers to a constellation of disorders that involve mutations that alter the release of fibrinopeptides, affect the rate of polymerization of fibrin monomers, or alter the sites of fibrin cross-linking. Dysfibrinogenemia is either inherited in an autosomal dominant fashion or acquired. Patients with liver disease, hepatomas, AIDS, and lymphoproliferative disorders may develop an acquired form of dysfibrinogenemia. The presence of altered partial thromboplastin time (PTT) and prothrombin time (PT)/INR reflects an abnormality in coagulation from the prothrombinase complex downstream to fibrin. Correction with a mixing study eliminates factor inhibition as a cause of the coagulation disorder. Other causes of prolongation of the PT and PTT include factor deficiencies in factor V or X, afibrinogenemia or dysfibrinogenemia, and consumption of coagulation factors from DIC. The absence of schistocytes from the blood smear makes DIC unlikely. The thrombin time tests the interaction with thrombin directly on fibrinogen. Its prolongation indicates an abnormality with that interaction and suggests a diagnosis of dysfibrinogenemia. Factor XIII deficiency is a bleeding disorder that manifests in childhood and is not consistent with this presentation.

68. The answer is C.

(Chap. 26) Chemoprevention involves the use of specific natural or synthetic chemical agents to reverse, suppress, or prevent carcinogenesis before the development of invasive malignancy. Calcium, by binding to luminal free fatty acids and bile, may reduce gastrointestinal endothelium proliferation. Calcium supplementation decreases the risk of adenomatous polyps by up to 20%. Trials with cancer-incidence end points are currently underway. High doses of relatively toxic isotretinoin caused regression of the premalignant oral leukoplakia lesions; however, lower doses were not effective in preventing

head and neck cancers. It also did not prevent second malignancies in patients cured of early stage non-small cell lung cancer.  $\beta$ -Carotene has been investigated for the chemoprevention of lung cancer in two trials. Both trials actually showed harm from  $\beta$ -carotene. Aspirin had no effect on colon cancer incidence in a 6-year trial. Cyclooxygenase-2 inhibitors have been shown to reduce recurrence rates for polyps in familial adenomatous polyposis. The effects on colon cancer in sporadic cases were initiated but were complicated by the association of these drugs with increased cardiovascular death. Tamoxifen is used for primary prevention of breast cancer among those at very high risk. It is associated with a small increase in the risk of endometrial cancer.

69. and 70. The answers are A and E.

(Chap. 14) Treatment of acute promyelocytic leukemia (PML) is an interesting example of how understanding the function of the protein produced by the genetic abnormality can be utilized to develop a treatment for the disease. The translocation of the long arms of chromosomes 15 and 17, t(15;17), results in the production of a chimeric protein called promyelocytic leukemia (Pml)/retinoic acid receptor  $\alpha$  (Rar $\alpha$ ). The Pml-Rar $\alpha$  fusion protein suppresses gene transcription and arrests differentiation of the cells in an immature state leading to promyelocytic leukemia. Pharmacologic doses of the ligand of the Rar- $\alpha$  receptor, all-*trans*-retinoic acid (ATRA), stimulate the cells to resume differentiation. With use of ATRA, the leukemic cells differentiate to mature neutrophils and undergo subsequent apoptosis. This leads to treatment and remission of PML without causing the myelosuppression that is common to other chemotherapy used for treatment of leukemia. Although ATRA alone can yield hematologic remission of PML, it is most often combined with traditional chemotherapeutic agents in order to generate a cytogenetic remission as well. Since introduction of ATRA into therapy of PML, complete remission and survival rates have further improved to ~75–80% at 5 years. The primary side effect of ATRA is the development of retinoic acid syndrome. The onset of retinoic acid syndrome from ATRA is usually within the first 3 weeks of treatment. Typical symptoms are chest pain, fever, and dyspnea. Hypoxia is common, and chest radiography usually shows diffuse alveolar infiltrates with pleural effusions. Pericardial effusions may also occur. The cause of retinoic acid syndrome is possibly related to the adhesion of the differentiated leukemia cells to the pulmonary endothelium or the release of cytokines by these cells to cause vascular leak. Mortality of retinoic acid syndrome is 10%. High-dose glucocorticoid therapy is usually effective in treatment of retinoic acid syndrome. Arsenic trioxide is currently indicated for the treatment of relapsed PML and is effective in up to 85% of individuals who are refractory to ATRA. Ongoing clinical trials are attempting to

determine if combination therapy with ATRA and arsenic may further improve outcomes in PML. Cyclophosphamide, daunorubicin, vinblastine, and prednisone are the constituents of the combination chemotherapy commonly known as CHOP, and it is indicated for the treatment of B cell lymphomas. Rituximab is most commonly used as a treatment of B cell non-Hodgkin's lymphoma and is currently under investigation for the treatment of chronic lymphocytic leukemia and a variety of refractory autoimmune disorders, including systemic lupus erythematosus and rheumatoid arthritis. Rituximab is a monoclonal antibody directed against the CD20 cell surface molecule of B lymphocytes. Neither of these drug regimens has a role in the treatment of myeloid leukemias. Whole-body irradiation is used primarily before bone marrow transplant to ensure complete eradication of cancerous leukemic cells in the bone marrow.

71. The answer is C.

(Chap. 14) Patients with acute leukemia frequently present with nonspecific symptoms of fatigue and weight loss. In addition, weight loss and anorexia are also common. About half have had symptoms for >3 months at the time of presentation. Fever is present in only ~10% of patients at presentation, and 5% have evidence of abnormal hemostasis. On physical examination, hepatomegaly, splenomegaly, sternal tenderness, and evidence of infection or hemorrhage are common presenting signs. Laboratory studies are confirmatory with evidence of anemia, thrombocytopenia, and leukocytosis often present. The median presenting leukocyte count at presentation is 15,000/ $\mu\text{L}$ . About 20–40% have presenting leukocyte counts of <5000/ $\mu\text{L}$ , and another 20% have counts >100,000/ $\mu\text{L}$ . Review of the peripheral smear confirms leukemia in most cases. If Auer rods are seen, the diagnosis of AML is virtually certain. Thrombocytopenia (platelet count <100,000/ $\mu\text{L}$ ) is seen in >75% of individuals with AML. Once the diagnosis of AML has been confirmed, rapid evaluation and treatment should be undertaken. The overall health of the cardiovascular, pulmonary, hepatic, and renal systems should be evaluated because chemotherapy has adverse effects that may cause organ dysfunction in any of these systems. Among the prognostic factors that predict poor outcomes in AML, age at diagnosis is one of the most important because individuals of advanced age tolerate induction chemotherapy poorly. In addition, advanced age is more likely to be associated with multiple chromosomal abnormalities that predict poorer response to chemotherapy, although some chromosomal markers predict a better response to chemotherapy. Poor performance status independent of age also decreases survival in AML. Chromosome findings at diagnosis are also very important in predicting outcomes in AML. Responsiveness to chemotherapy and survival are also worse if the

leukocyte count >100,000/ $\mu\text{L}$  or the antecedent course of symptoms is prolonged. Anemia, leukopenia, or thrombocytopenia present for >3 months is a poor prognostic indicator. However, there is no absolute degree of anemia or thrombocytopenia that predicts worse outcomes.

72. The answer is C.

(Chap. 26) The sensitivity of a test is a numerical description of the test's ability to detect the disease when it is present. It is the proportion of persons with the condition who also test positive. In this example, 1000 people test positive using the screening test. The number of persons who actually have the condition is 1250, yielding an 80% sensitivity.

73. The answer is B.

(Chap. 26; *NEJM* 349:2191, 2003) For colon cancer screening, the three major preventive societies (i.e., American Cancer Society, The United States Preventive Services Task Force, and the Canadian Task Force on Preventive Health Care) recommend sigmoidoscopy, colonoscopy, or fecal occult blood testing (FOBT) starting at 50 years of age. Digital rectal examination is not recommended. FOBT has a high false-positive rate; 2–10% of those with a positive result have colon cancer, and ~25% have adenomas. Sigmoidoscopy has been shown to reduce mortality, and the recommended screening interval is 5 years. Sigmoidoscopy carries a perforation risk of 1/1000, whereas the risk with colonoscopy is three times greater. Colonoscopy detects more advanced lesions and is the screening test of choice in subjects who are at high risk. Virtual colonoscopy using CT imaging can detect adenomatous polyps, compares favorably with endoscopic colonoscopy for polyps >8 mm, and may be an effective screening method in average-risk adults. It is not as sensitive as endoscopic colonoscopy for small (<5 mm) polyps.

74. The answer is C.

(Chap. 51) Superior vena cava (SVC) syndrome is the clinical manifestation of superior vena cava obstruction with severe reduction in venous return from the head, neck, and upper extremities. Small cell and squamous cell lung cancer account for 85% of all cases of malignant superior vena cava obstruction. Common complaints include neck and facial swelling with dyspnea. Other symptoms include hoarseness, tongue swelling, headaches, nasal congestion, epistaxis, hemoptysis, dysphagia, pain, dizziness, syncope, and lethargy. Temporizing measures include diuretics, low-salt diet, oxygen, and head elevation. Glucocorticoids may be effective for shrinking the size of lymphomatous masses, but they are of no benefit in patients with primary lung cancer. Radiation therapy is the primary treatment for SVC syndrome due to non-small cell lung cancer.

Chemotherapy is most effective for small cell lung cancer, lymphoma, or germ cell tumors. Some non-small cell lung tumors are responsive to novel chemotherapy agents. Intravascular stenting is effective for palliation and may be considered to prevent recurrence.

75. The answer is D.

(Chap. 14) Acute myeloid leukemias (AML) are a group of hematologic malignancies derived from hematologic stem cells that have acquired chromosomal mutations that prevent differentiation into mature myeloid cells. The specific chromosomal abnormalities predict in which stage of differentiation the cell is arrested and are associated with the several subtypes of AML that have been identified. In the United States, >16,000 new cases of AML are diagnosed yearly, and the numbers of new cases of AML has increased in the past 10 years. Men are diagnosed with AML more frequently than women (4.6 cases per 100,000 population vs 3.0 cases per 100,000). In addition, older age is associated with increased incidence of AML, with an incidence of 18.6 cases per 100,000 population in those >65 years. AML is uncommon in adolescents. Other known risk factors for development of AML include hereditary genetic abnormalities, radiation and chemical exposures, and drugs. The most common hereditary abnormality linked to AML is trisomy 21 (Down's syndrome). Other hereditary syndromes associated with an increase of AML include diseases associated with defective DNA repair such as Fanconi's anemia and ataxia telangiectasia. Survivors of the atomic bomb explosions in Japan were found to have a high incidence of AML as have survivors of other high-dose radiation exposures. However, therapeutic radiation is not associated with an increased risk of AML unless the patient was also treated concomitantly with alkylating agents. Anti-cancer drugs are the most common causes of drug-associated AML. Of the chemotherapeutic agents, alkylating agents and topoisomerase II inhibitors are the drugs most likely to be associated with AML.

76. The answer is B.

(Chap. 44) Patients with cancer from an unknown primary site present a common diagnostic dilemma. Initial evaluation should include history, physical examination, appropriate imaging, and blood studies based on gender (e.g., prostate-specific antigen in men, mammography in women). Immunohistochemical staining of biopsy samples using antibodies to specific cell components may help elucidate the site of the primary tumor. Although many immunohistochemical stains are available, a logical approach is represented in the figure. Additional tests may be helpful based on the appearance under light microscopy and/or the results of the cytokeratin stains. In cases of cancer of unknown primary, cytokeratin staining is usually the first branch point from which the tumor lineage is determined. Cytokeratin is positive in

carcinoma because all epithelial tumors contain this protein. Subsets of cytokeratin, such as CK7 and CK20, may be useful to determine the likely etiology of the primary tumor. Leukocyte common antigen, thyroglobulin, and thyroid transcription factor 1 are characteristic of lymphoma, thyroid cancer, and lung or thyroid cancer, respectively.  $\alpha$  Fetoprotein staining is typically positive in germ cell, stomach, and liver carcinoma. (See Fig. 44-1.)

77. The answer is C.

(Chap. 14) Imatinib mesylate is a tyrosine kinase inhibitor that acts to decrease the activity of the bcr-abl fusion protein that results from the reciprocal translocation of chromosomes 9 and 22 (Philadelphia chromosome). It acts as a competitive inhibitor of the abl kinase at its ATP binding site and thus leads to inhibition of tyrosine phosphorylation of proteins in *bcr-abl* signal transduction. Imatinib mesylate results in hematologic remission in 97% of treated individuals at 18 months and cytogenetic remission of 76%. This is compared to traditional chemotherapy of interferon- $\alpha$  and cytarabine, which resulted in hematologic remission in 69% and cytogenetic remission in only 14% of individuals. More than 87% of individuals who achieved cytogenetic remission had not developed progressive disease at 5 years. This drug taken orally has limited side effects that include nausea, fluid retention, diarrhea, and skin rash and is usually well tolerated. If individuals do not achieve hematologic remission by 3 months or complete cytogenetic remission by 12 months, it is recommended that they proceed to allogeneic bone marrow transplant. Although imatinib is the best initial therapy to achieve hematologic and cytogenetic remission, individuals who have a well-matched related bone marrow donor may proceed to early allogeneic transplant, particularly if the individual is <18 years of age. This is done because younger individuals generally have better outcomes following bone marrow transplant than older individuals, and the durability of responses to imatinib mesylate is not known at this time. Interferon- $\alpha$  was previously the first-line chemotherapy if bone marrow transplant was not an option, but it has been replaced by imatinib mesylate. Autologous stem cell transplant is not currently used for treatment of CML because there is no reliable way to select residual normal hematopoietic progenitor cells. Clinical trials utilizing autologous stem cell transplantation are currently underway to determine if this treatment may be possible following control of disease with imatinib therapy. Leukopheresis is used for control of leukocyte counts when the patient is experiencing complications such as respiratory failure or cerebral ischemia related to the high white blood cell count.

78. The answer is A.

(Chap. 34; Collaborative Group in Hormonal Factors in Breast Cancer, 2002.) Approximately 80–90% of the variation in

breast cancer frequency in different countries can be attributed to differences in menarche, first pregnancy, and menopause. Women who experience menarche at age 16 have 40–50% the risk of breast cancer of women who experience menarche at age 12 years. Menopause, surgical or natural, occurring 10 years before the median age of 52 years reduces the risk of breast cancer by 35%. Women who have the first full-term pregnancy by age 18 have a 30–40% reduced risk of breast cancer compared with nulliparous women. These data taken together suggest that a substantial portion of the risk of developing breast cancer is related directly to the length of menstrual life, particularly the fraction occurring before the first full-term pregnancy. Independently of these factors, the duration of maternal nursing is associated with a reduction in breast cancer risk.

79. The answer is D.

(Chap. 19) The aPTT involves the factors of the intrinsic pathway of coagulation. Prolongation of the aPTT reflects either a deficiency of one of these factors (factor VIII, IX, XI, XII, etc.) or inhibition of the activity of one of the factors or components of the aPTT assay (i.e., phospholipids). This may be further characterized by the “mixing study,” in which the patient’s plasma is mixed with pooled plasma. Correction of the aPTT reflects a deficiency of factors that are replaced by the pooled sample. Failure to correct the aPTT reflects the presence of a factor inhibitor or phospholipid inhibitor. Common causes of a failure to correct include the presence of heparin in the sample, factor inhibitors (factor VIII inhibitor being the most common), and the presence of antiphospholipid antibodies. Factor VII is involved in the extrinsic pathway of coagulation. Inhibitors to factor VII would result in prolongation of the prothrombin time.

80. The answer is A.

(Chap. 22) Aspirin is the most widely used antiplatelet agent worldwide and is cheap and effective for both primary and secondary prevention of cardiovascular disease. Aspirin can be recommended for primary cardiovascular prevention in patients whose annual estimated risk of a cardiovascular event is >1%. This includes patients >40 years of age who have two or more major cardiovascular risk factors and patients >50 years of age with one major cardiovascular risk factor. The major risk factors in this patient who is >50 are diabetes mellitus and family history. Other contributing risk factors include obesity and a history of tobacco use, although this is not ongoing. Aspirin is equally effective in men and women, and menopausal status does not impact its efficacy. However, there is a differential effect of aspirin in men and women. In men, aspirin has a greater risk reduction on the incidence of myocardial infarction, whereas in women, there is a greater risk reduction in the occurrence of stroke.

The most common side effect of aspirin is major bleeding at a rate of 1–3% yearly. Enteric-coated and buffered preparations decrease, but do not eliminate, this risk. The risk of bleeding is higher if administered concurrently with other anticoagulant or antiplatelet medications. Aspirin does not cause an increased risk of menorrhagia. Finally, aspirin should be used with caution in individuals with a history of bronchospasm in association with nonsteroidal anti-inflammatory drugs (NSAIDs) or aspirin. Usually, these patients have a history of asthma and nasal polyposis (Samter’s triad). However, this patient reports only gastrointestinal upset with ibuprofen. Although GI upset is a common adverse reaction with NSAIDs, it does not denote a true allergy.

81. The answer is C.

(Chap. 42) The most common malignant tumors of bone are plasma cell tumors related to multiple myeloma. The bone lesions are lytic lesions due to increased osteoclast activity, without osteoblastic new bone formation. Of the nonhematopoietic tumors, the most common are osteosarcoma, chondrosarcoma, Ewing’s sarcoma, and malignant fibrous histiocytoma. Osteosarcomas account for 45% of bone sarcomas and produce osteoid (unmineralized bone) or bone. They typically occur in children, adolescents, and adults to the third decade. The “sunburst” appearance of the lesion and Codman’s triangle in this young man are indicative of an osteosarcoma. Osteosarcomas have a predilection for long bones, whereas chondrosarcomas are more often found in flat bones, especially the shoulder and pelvic girdles. Osteosarcomas are radioresistant. Long-term survival with combined chemotherapy and surgery is 60–80%. Chondrosarcomas account for 20–25% of bone sarcomas and are most common in adults in the fourth to sixth decades. They typically present indolently with pain and swelling. They are often difficult to distinguish from benign bone lesions. Most chondrosarcomas are chemoresistant, and the mainstay of therapy is resection of the primary as well as metastatic sites.

82. The answer is A.

(Chap. 19) Hemophilia A results from an inherited deficiency of factor VIII. The gene for factor VIII is on the X chromosome. Therefore, its X-linked inheritance pattern results in ~1 in 10,000 male patients being born with some level of dysfunction. Clinically, it is characterized by bleeding into soft tissues, muscles, and weight-bearing joints. Symptomatic patients usually have levels <5%. Bleeding occurs hours or days after an injury and can involve any organ. Factor VIII is involved in the intrinsic pathway of coagulation. Therefore, deficiency usually results in abnormalities of the activated partial thromboplastin time. Factor VIII has a very short half-life of 8–12 h. Therefore, repeated transfusions of plasma, cryoprecipitate, or purified factor VIII must be given at

least twice daily. Factor VIII complexes to von Willebrand's factor, not Hageman's factor.

83. The answer is A.

(Chap. 35) The rates of gastric cancer have declined significantly over the past 75 years. Nevertheless, there were >20,000 new cases in the United States with >10,000 deaths in 2007. Gastric cancer still has a high incidence in Japan, China, Chile, and Ireland. Epidemiologic evidence, such as the higher prevalence in lower socioeconomic groups and the maintenance of risk for individuals but not offspring migrating from a high-risk to low-risk environment, suggests an environmental exposure early in life is a risk. Risk is associated with ingestion of high nitrite foods. The nitrites may be converted to carcinogens by bacteria in partially decayed food. Chronic gastritis and achlorhydria due to *Helicobacter pylori* gastric infection may contribute to this risk. The effect of *H. pylori* eradication on risk of gastric cancer is under investigation. The combination of recognition of *H. pylori* infection, improved food preservation, and widespread availability of refrigeration may all be contributing to the declining incidence. The most common histologic type of stomach cancer is adenocarcinoma. The majority of adenocarcinomas occur in the distal stomach and appear ulcerative on contrast radiography and endoscopy. Therefore, all gastric ulcers warrant a biopsy and brushings for early detection of adenocarcinoma of the stomach. Such early lesions have the highest likelihood for surgical cure. Some 13% of gastric adenocarcinomas are diffuse-type, involve most of the stomach, and are referred to as *linitis plastica* based on poor distensibility of the stomach. Prognosis for diffuse carcinomas is worse than for intestinal type, and this disease is seen more commonly in the young. There is not a good association between this type of gastric cancer and *H. pylori* infection. For all adenocarcinomas, the presence of palpable periumbilical nodes, or Sister Mary Joseph's nodes, implies metastatic spread and confers a poor prognosis. Surgery should be considered first-line therapy for cure or palliation/debulking if the patient is a surgical candidate. It is critical to differentiate adenocarcinoma from gastric lymphoma because lymphoma carries a much better prognosis, with *H. pylori* eradication causing regression in 75% of cases. Antimicrobial therapy should be considered before surgery, radiation, or chemotherapy in gastric lymphoma. Surgery, usually with chemotherapy, may be curative in 40–60% of patients with resistant or high-grade lymphoma.

84. The answer is F.

(Chap. 1) All peripheral blood cells and some cells in peripheral tissue are derived from hematopoietic stem cells. When hematopoietic stem cells are irreversibly damaged, as in severe radiation exposure, an individual cannot survive longer than a few weeks. The two cardinal

features of stem cells are the ability to differentiate into a variety of mature cell types and the capacity for self-renewal. The ability to differentiate into a variety of cell types allows stem cells to participate in the maintenance and repair of tissues. In addition, the capacity for self-renewal assures an ongoing supply of stem cells to continually maintain adequate tissue function. These characteristics are the basis for the growing excitement regarding the use of stem cells for a wide array of medical conditions including (but limited to) diabetes, spinal cord injury, cardiomyopathy, hematologic disorders, and enzyme deficiencies.

85. The answer is B.

(Chap. 51) The malignant spinal cord compression (MSCC) syndrome is defined as compression of the spinal cord and/or cauda equina by an extradural tumor mass. The minimum radiologic evidence for cord compression is compression of the theca at the level of clinical features. However, radiologic confirmation is not necessary in a patient whose physical examination suggests cord compression. These patients should receive immediate high-dose dexamethasone (24 mg IV every 6 h). Cancers that most commonly cause the MSCC syndrome include prostate, lung, and breast. Renal cell carcinoma, lymphomas, and melanomas may also cause cord compression. The most commonly affected site is the thoracic spine (70% of cases), followed by the sacral spine (20%). Pain is usually present for days or months before the neurologic defects manifest. Some 75% percent of patients who are ambulatory at the time of diagnosis remain ambulatory, whereas <10% of patients who present paraplegic regain the ability to walk despite treatment.

86. The answer is B.

(Chap. 27) Tumor lysis syndrome is a well-recognized clinical entity that is characterized by metabolic derangements secondary to the destruction of tumor cells. Lysis of cells causes the release of intracellular pools of phosphate, potassium, and nucleic acids, leading to hyperphosphatemia and hyperuricemia. Lactic acidosis frequently develops for similar reasons. The increased urine acidity may promote the formation of uric acid nephropathy and subsequent renal failure. Hyperphosphatemia promotes a reciprocal depression in serum calcium. This hypocalcemia may result in severe neuromuscular irritability and tetany.

87. The answer is E.

(Chap. 20) The clinical probability of PE can be delineated into likely versus unlikely using the clinical decision rule shown in the table. In those with a score  $\leq 4$ , PE is unlikely and a D-dimer test should be performed. A normal D-dimer combined with an unlikely clinical probability of PE identifies patients who do not need further testing or anticoagulation therapy. Those with

either a likely clinical probability (score >4) or an abnormal D-dimer (with unlikely clinical probability) require an imaging test to rule out PE. Currently the most attractive imaging method to detect PE is the multislice CT scan. It is accurate and, if normal, safely rules out PE. This patient has a clinical probability score of 4.5 because of her resting tachycardia and the lack of an alternative diagnosis at least as likely as PE. Therefore, there is no indication for measuring D-dimer, and she should proceed directly to multislice CT of the chest. If this cannot be performed expeditiously, she should receive one dose of low-molecular-weight heparin while awaiting the test. (See Table 20-3.)

88. The answer is D.

(Chap. 20) The goal of treatment with vitamin K antagonists, including warfarin, is maintenance of an INR of 2–3, with a goal of 2.5. Higher intensity treatment is not more effective and has a higher bleeding risk. Lower intensity treatment is less effective, with a similar bleeding risk. The recommendations for duration of therapy for the first episode of deep vein thrombosis (DVT) or pulmonary embolism (PE) are shown in the table in the previous question. Generally, recurrent PE/DVT is treated for at least 12 months. All treatment decisions require balancing risk of recurrence or long-term sequelae with bleeding risk as well as patient preference.

89. The answer is C.

(Chap. 26) No study of breast self-examination has shown a reduced mortality due to breast cancer, despite being associated with higher rates of biopsy. The procedure is still recommended as prudent by many organizations; however, only the American Cancer Society recommends monthly BSE in women >19 years. The United States Preventive Services Task Force (USPSTF) provides no recommendation for BSE, and the Canadian Task Force on Preventive Health Care (CTFPHC) excludes its use as a useful screening technique. A substantial fraction of breast cancers are first detected by patients. Although mortality rates have not declined as a result of BSE, the size of lumps detected by patients have steadily gotten smaller since the 1990s.

90. The answer is D.

(Chap. 34) Pathologic staging remains the most important determinant of overall prognosis. Other prognostic factors have an impact on survival and the choice of therapy. Tumors that lack estrogen and/or progesterone receptors are more likely to recur. The presence of estrogen receptors, particularly in postmenopausal women, is also an important factor in determining adjuvant chemotherapy. Tumors with a high growth rate are associated with early relapse. Measurement of the proportion of cells in S-phase is a measure of the growth rate. Tumors with more than the median number of cells in

S-phase have a higher risk of relapse and an improved response rate to chemotherapy. Histologically, tumors with a poor nuclear grade have a higher risk of recurrence than do tumors with a good nuclear grade. At the molecular level, tumors that overexpress *erbB2* (*HER-2/neu*) or that have a mutated p53 gene portend a poorer prognosis for patients. The overexpression of *erbB2* is also useful in designing optimal treatment regimens, and a human monoclonal antibody to *erbB2* (Herceptin) has been developed.

91. The answer is E.

(Chap. 51) Tumor lysis syndrome is characterized by hyperuricemia, hyperkalemia, hyperphosphatemia, and hypocalcemia. Metabolic acidosis occurs frequently. Acute renal failure is common, and hemodialysis should be considered early in the treatment of this problem. Effective cancer therapy kills cells, which release uric acid from the turnover of nucleic acids. In an acidic environment, uric acid can precipitate in the renal tubules, medulla, and collecting ducts leading to renal failure. Hyperphosphatemia and hyperkalemia also occur as a result of cell death. Hyperphosphatemia produces a reciprocal depression in serum calcium. Indications for hemodialysis include extreme hyperkalemia (>6.0 meq/L), hyperuricemia (>10 mg/dL), hyperphosphatemia (>10 mg/dL or rapidly increasing), or symptomatic hypocalcemia. Daily uric acid levels should be monitored; excellent renal recovery can be expected once the uric acid level is <10 mg/dL.

92. The answer is B.

(Chap. 22) Fondaparinux is a direct factor Xa inhibitor that is a synthetic analogue of the pentasaccharide sequence found in heparin. A smaller compound than either unfractionated heparin or low-molecular-weight heparin (LMWH), fondaparinux acts by binding antithrombin and catalyzing factor Xa inhibition. At only 5 polysaccharide units, fondaparinux is too small to bridge antithrombin to thrombin and does not potentiate thrombin inhibition. Fondaparinux is given by the subcutaneous route and has 100% bioavailability without plasma protein binding. Like LMWH, it has a predictable anticoagulant effect and monitoring of factor Xa levels is not required. It is excreted unchanged in the urine. Fondaparinux is absolutely contraindicated in those with a creatinine clearance of <30 mL/min and should be used with caution in individuals with a creatinine clearance of <50 mL/min. The individual presented in scenario B has a creatinine clearance of 32 mL/min and should not receive fondaparinux.

Currently, fondaparinux is approved for prophylaxis against venous thromboembolic disease (VTE) following general surgery and orthopedic procedures. In addition, fondaparinux has been shown to be equivalent to heparin and LMWH in initial treatment of both deep

vein thrombosis and pulmonary embolus. Recent studies have demonstrated equivalency with enoxaparin in the treatment of non-ST elevation acute coronary syndromes. Finally, there have been several case reports of successful use of fondaparinux in the treatment of heparin-induced thrombocytopenia because there is no cross-reactivity between it and heparin-induced thrombocytopenia antibodies.

The usual dosage of fondaparinux is 7.5 mg once daily. In individuals weighing <50 kg, the dose should be reduced to 5 mg. Likewise, in those weighing >100 kg, the dose is increased to 10 mg.

93. The answer is A.

(Chap. 34) During pregnancy the breast grows under the influence of estrogen, progesterone, prolactin, and human placental lactogen. However, the presence of a dominant breast nodule/mass during pregnancy should never be attributed to hormonal changes. Breast cancer develops in 1 in 3000–4000 pregnancies. The prognosis for breast cancer by stage is no different in pregnant compared with pregnant women. Nevertheless, pregnant women are often diagnosed with more advanced disease because of delay in the diagnosis. Pregnant patients with persistent lumps in the breast should receive prompt diagnostic evaluation.

94. The answer is D.

(Chap. 11) Aplastic anemia is defined as pancytopenia with bone marrow hypocellularity. Aplastic anemia may be acquired, iatrogenic (chemotherapy), or genetic (e.g., Fanconi's anemia). Acquired aplastic anemia may be due to drugs or chemicals (expected toxicity or idiosyncratic effects), viral infections, immune diseases, paroxysmal nocturnal hemoglobinuria, pregnancy, or idiopathic causes. Aplastic anemia from idiosyncratic drug reactions (including those listed as well as others including quinacrine, phenytoin, sulfonamides, cimetidine) are uncommon but may be encountered given the wide usage of some of these agents. In these cases there is usually not a dose-dependent response; the reaction is idiosyncratic. Seronegative hepatitis is a cause of aplastic anemia, particularly in young men who recovered from an episode of liver inflammation 1–2 months prior. Parvovirus B19 infection most commonly causes pure red cell aplasia, particularly in patients with chronic hemolytic states and high RBC turnover (e.g., sickle cell anemia).

95. The answer is D.

(Chap. 11) This patient has aplastic anemia. In the absence of drugs or toxins that cause bone marrow suppression, it is most likely that he has immune-mediated injury. Growth factors are not effective in the setting of a hypoplastic marrow. Transfusion should be avoided unless emergently needed to prevent the development of alloantibodies. Glucocorticoids have no efficacy in

aplastic anemia. Immunosuppression with antithymocyte globulin and cyclosporine is a therapy with proven efficacy for this autoimmune disease with a response rate of up to 70%. Relapses are common, and myelodysplastic syndrome or leukemia may occur in ~15% of treated patients. Immunosuppression is the treatment of choice for patients without suitable bone marrow transplant donors. Bone marrow transplantation is the best current therapy for young patients with matched sibling donors. Allogeneic bone marrow transplants from matched siblings result in long-term survival in >80% of patients, with better results in children than adults.

96. The answer is E.

(Chap. 11) The combination of intravascular hemolysis (hemoglobinuria) and thrombosis in an unusual location (particularly in proximity to the abdominal viscera) should prompt a search for paroxysmal nocturnal hemoglobinuria (PNH). PNH results from an acquired mutation in stem cells resulting in the loss of a glycosylphosphatidylinositol-linked cell surface membrane proteins in a clone of granulocytes. Diagnosis is made by flow cytometry of CD55 or CD59 expression on these granulocytes. The Ham or sucrose lysis tests are no longer routinely performed. Clones of deficient cells are often detected in patients with aplastic anemia. Adenocarcinomas are strongly associated with thrombosis (Trousseau's syndrome) and may cause ascites, but hemolysis without microangiopathic hemolytic anemia makes this less likely. Other causes of a hypercoagulable state such as those listed should be examined if an evaluation for PNH is negative.

97. The answer is B.

(Chap. 19) This patient has a coagulation disorder characterized by recurrent bleeding episodes into closed spaces with an inheritance pattern suggestive of a recessive or X-linked pattern. An isolated prolonged prothrombin time suggests factor VII deficiency, which is inherited in an autosomal recessive pattern. The thrombin time will also be normal in these cases. Although hemophilia A (factor VIII deficiency) and hemophilia B (factor IX deficiency) are the most common inherited factor deficiencies, these disorders do not cause an isolated prolonged prothrombin time. They will cause a prolongation of the aPTT with a normal PT. Both hemophilias are inherited in an X-linked pattern. Prothrombin deficiency is a rare autosomal recessive disorder that will cause prolongation of the aPTT, PT, and thrombin time. Ingestion of warfarin may also cause this clinical scenario but is less likely given the inheritance pattern.

98. The answer is C.

(Chap. 19) An elevated aPTT with a normal PT is consistent with a functional deficiency of Factor VIII, IX, XI, XII, high-molecular-weight kininogen, or prekallikrein.

Congenital or nutritional deficiencies of these factors will be corrected in the laboratory by the addition of serum from a normal subject. The presence of a specific antibody to a coagulation factor is termed an *acquired inhibitor*. Usually these are directed against factor VIII, although acquired inhibitors to prothrombin, factor V, factor IX, factor X, and factor XI are described. Patients with acquired inhibitors are typically older adults (median age: 60 years) with pregnancy or postpartum states less common. No underlying disease is found in 50%. The most common underlying diseases are autoimmune diseases, malignancies (lymphoma, prostate cancer), and dermatologic diseases. Acquired factor VIII or IX inhibitors present clinically in the same fashion as congenital hemophilias. Developing the coagulation disorder later in life is more suggestive of an acquired inhibitor if there is no antecedent history of coagulopathy. Syphilis infection is a cause of a falsely abnormal aPTT, but because this is a laboratory phenomenon, there is no associated clinical coagulopathy. Vitamin C deficiency may cause gingival bleeding and a perifollicular petechial rash but does not cause significant hemarthroses or a prolonged aPTT. A tobacco history and laboratory evidence of chronic illness (anemia, hypoalbuminemia) in this scenario raise the suspicion of an underlying malignancy.

99. The answer is A, although B is possible.

(Chap. 19) Hemophilia A (absent factor VIII) and hemophilia B (absent factor IX) are indistinguishable clinically. Hemophilia A accounts for 80% of the cases of hemophilia. It has a prevalence in the general population of 1 in 5000 in contrast to hemophilia B that has a prevalence of 1 in 30,000. The disease phenotype correlates with the amount of residual factor activity and can be classified as severe (<1% activity), moderate (1–5% activity), or mild (6–30% activity). The patient in this scenario is likely to have a mild form of the disease. Hemophiliacs have a normal bleeding time, platelet count, thrombin time, and prothrombin time. The diagnosis is made by measuring residual factor activity. The prolonged aPTT in hemophilia is corrected by mixing with normal plasma (that contains the deficient factors VIII and IX). Patients with acquired inhibitors will not correct the prolonged aPTT with normal plasma because the defect is antibody mediated.

100. The answer is D.

(Chap. 19) This patient presents with a significant upper GI bleed with a prolonged prothrombin time. Hemophilia should not cause a prolonged prothrombin time. This and the presence of ascites raise the possibility of liver disease and cirrhosis. The contamination of blood products in the 1970s and 1980s resulted in widespread transmission of HIV and hepatitis C within the hemophilia population receiving factor infusions. It is estimated in 2006 that >80% of hemophilia patients >20 years of

age are infected with hepatitis C virus. Viral inactivation steps were introduced in the 1980s, and recombinant factor VIII and IX were first produced in the 1990s. Hepatitis C is the major cause of morbidity and the second leading cause of death in patients exposed to older factor concentrates. Patients develop cirrhosis and the complications including ascites and variceal bleeding. End-stage liver disease requiring a liver transplant will be curative for the cirrhosis and the hemophilia (the liver produces factor VIII). Hepatitis B was not transmitted in significant numbers to patients with hemophilia. Diverticular disease or peptic ulcer disease would not explain the prolonged prothrombin time. Patients with inadequately repleted factor VIII levels are more likely to develop hemarthroses than GI bleeds, and the slightly prolonged aPTT makes this unlikely.

101. The answer is E.

(Chap. 19) The differentiation between DIC and severe liver disease is challenging. Both entities may manifest with similar laboratory findings: elevated fibrinogen degradation products, prolonged aPTT and PT, anemia, and thrombocytopenia. When suspecting DIC, these tests should be repeated over a period of 6–8 hours because abnormalities may change dramatically in patients with severe DIC. In contrast, these tests should not fluctuate as much in patients with severe liver disease. Bacterial sepsis with positive blood cultures is a common cause of DIC but is not diagnostic.

102. The answer is E.

(Chap. 13) In a patient presenting with an elevated hemoglobin and hematocrit, the initial step in the evaluation is to determine whether erythrocytosis represents a true elevation in red cell mass or whether spurious erythrocytosis is present due to plasma volume contraction. This step may be not necessary, however, in those individuals with hemoglobin >20 g/dL. Once absolute erythrocytosis has been determined by measurement of red cell mass and plasma volume, the cause of erythrocytosis must be determined. If there is not an obvious cause of the erythrocytosis, an erythropoietin level should be checked. An elevated erythropoietin level suggests hypoxia or autonomous production of erythropoietin as the cause of erythrocytosis. However, a normal erythropoietin level does not exclude hypoxia as a cause. A low erythropoietin level should be seen in the myeloproliferative disorder polycythemia vera (PV), the most likely cause of erythrocytosis in this patient. PV is often discovered incidentally when elevated hemoglobin is found during testing for other reasons. When symptoms are present, the most common complaints are related to hyperviscosity of the blood and include vertigo, headache, tinnitus, and transient ischemic attacks. Patients may also complain of pruritus after showering. *Erythromelalgia* is the term given to the symptoms complex of



burning, pain, and erythema in the extremities and is associated with thrombocytosis in PV. Isolated systolic hypertension and splenomegaly may be found. In addition to elevated red blood cell mass and low erythropoietin levels, other laboratory findings in PV include thrombocytosis and leukocytosis with abnormal leukocytes present. Uric acid levels and leukocyte alkaline phosphatase may be elevated but are not diagnostic for PV. Approximately 30% of individuals with PV are homozygous for the JAK2 V617F mutation, and >90% are heterozygous for this mutation. This mutation located on the short arm of chromosome 9 causes constitutive activation of the JAK protein, a tyrosine kinase that renders erythrocytes resistant to apoptosis and allows them to continue production independently from erythropoietin. However, not every patient with PV expresses this mutation. Thus it is not recommended as a diagnostic test for PV at this time. Bone marrow biopsy provides no specific information in PV and is not recommended.

103. The answer is F.

(Chap. 40) This patient's lymphadenopathy is benign. Inguinal nodes <2 cm are common in the population at large and need no further workup provided there is no other evidence of disseminated infection or tumor and the nodes have qualities that do not suggest tumor (not hard or matted). A practical approach would be to measure the nodes or even photograph them if visible, and follow them serially over time. Occasionally, inguinal lymph nodes can be associated with sexually transmitted diseases. However, these are usually ipsilateral and tender, and evaluation for this would include bimanual examination and appropriate cultures, not necessarily pelvic ultrasound. Total-body CT scan would be indicated if other pathologic nodes suggestive of lymphoma or granulomatous disease are present in other anatomic locations. Bone marrow biopsy would be indicated only if a diagnosis of lymphoma is made first.

104. The answer is E.

(Chap. 4) Hard, matted, nontender lymph nodes are worrisome for tumor and should always prompt a workup, including excisional biopsy, if possible, and examination for a primary source depending on the location of the nodes. Supraclavicular lymphadenopathy should always be considered abnormal, particularly when documented on the left side. A thorough investigation for cancer, particularly with a primary gastrointestinal source, is necessary. Splenomegaly associated with diffuse adenopathy can be associated with tumor, particularly lymphoma, but is most often associated with systemic infections, such as mononucleosis, cytomegalovirus, or HIV, that often cause diffuse lymphadenopathy. Generalized lymphadenopathy and splenomegaly may be found in autoimmune diseases such as systemic lupus erythematosus or mixed connective tissue disease. Tender adenopathy of the cervical

anterior chain is nearly always associated with infection of the head and neck, most commonly a viral upper respiratory infection.

105. The answer is C.

(Chap. 4) Portal hypertension causes splenomegaly via passive congestion of the spleen. It generally causes only mild enlargement of the spleen because expanded varices provide some decompression for elevated portal pressures. Myelofibrosis necessitates extramedullary hematopoiesis in the spleen, liver, and even other sites such as the peritoneum, leading to massive splenomegaly due to myeloid hyperproduction. Autoimmune hemolytic anemia requires the spleen to dispose of massive amounts of damaged red blood cells, leading to reticuloendothelial hyperplasia and frequently an extremely large spleen. Chronic myelogenous leukemia and other leukemias/lymphomas can lead to massive splenomegaly due to infiltration with an abnormal clone of cells. If a patient with cirrhosis or right-heart failure has massive splenomegaly, a cause other than passive congestion should be considered.

106. The answer is A.

(Chap. 4) The presence of Howell-Jolly bodies (nuclear remnants), Heinz bodies (denatured hemoglobin), basophilic stippling, and nucleated red blood cells in the peripheral blood implies that the spleen is not properly clearing senescent or damaged red blood cells from the circulation. This usually occurs because of surgical splenectomy but is also possible when there is diffuse infiltration of the spleen with malignant cells. Hemolytic anemia can have various peripheral smear findings depending on the etiology of the hemolysis. Spherocytes and bite cells are an example of damaged red cells that might appear due to autoimmune hemolytic anemia and oxidative damage, respectively. DIC is characterized by schistocytes and thrombocytopenia on smear, with elevated INR and activated partial thromboplastin time as well. However, in these conditions, damaged red cells are still cleared effectively by the spleen. Transformation to acute leukemia does not lead to splenic damage.

107. The answer is A.

(Chap. 4) Splenectomy leads to an increased risk of overwhelming postsplenectomy sepsis, an infection that carries an extremely high mortality rate. The most commonly implicated organisms are encapsulated. *Streptococcus pneumoniae*, *Haemophilus influenzae*, and sometime gram-negative enteric organisms are most frequently isolated. There is no known increased risk for any viral infections. Vaccination for *S. pneumoniae*, *H. influenzae*, and *Neisseria meningitidis* is indicated for any patient who may undergo splenectomy. The vaccines should be given at least 2 weeks before surgery. The highest risk of sepsis occurs in patients <20 years of age because the spleen is

responsible for first-pass immunity, and younger patients are more likely to have primary exposure to implicated organisms. The risk is highest during the first 3 years after splenectomy and persists at a lower rate until death.

108. The answer is C.

(Chap. 4) To keep body weight stable, energy intake must match energy output. Energy output has two main determinants: resting energy expenditure and physical activity. Other, less clinically important determinants include energy expenditure to digest food and thermogenesis from shivering. Resting energy expenditure can be calculated and is  $900 + 10w$  (where  $w$  = weight) in males and  $700 + 7w$  in females. This calculation is then modified for physical activity level. The main determinant of resting energy expenditure is lean body mass.

109. The answer is C.

(Chap. 46) This patient presents with the classic findings of a VIPoma, including large-volume watery diarrhea, hypokalemia, dehydration, and hypochlorhydria (WDHA, or Verner-Morrison, syndrome). Abdominal pain is unusual. The presence of a secretory diarrhea is confirmed by a stool osmolal gap [ $2(\text{stool Na} + \text{stool K}) - (\text{stool osmolality})$ ]  $< 35$  and persistence during fasting. In osmotic or laxative-induced diarrhea, the stool osmolal gap is  $> 100$ . In adults,  $> 80\%$  of VIPomas are solitary pancreatic masses that usually are  $> 3$  cm at diagnosis. Metastases to the liver are common and preclude curative surgical resection. The differential diagnosis includes gastrinoma, laxative abuse, carcinoid syndrome, and systemic mastocytosis. Diagnosis requires the demonstration of large-volume secretory diarrhea ( $> 700$  mL/d) and elevated serum VIP. CT scan of the abdomen often demonstrates the pancreatic mass and liver metastases.

110. The answer is E.

(Chap. 48) Complete removal of the pheochromocytoma is the only therapy that leads to a long-term cure, although 90% of tumors are benign. However, preoperative control of hypertension is necessary to prevent surgical complications and lower mortality. This patient is presenting with encephalopathy in a hypertensive crisis. The hypertension should be managed initially with IV medications to lower the mean arterial pressure by  $\sim 20\%$  over the initial 24-h period. Medications that can be used for hypertensive crisis in pheochromocytoma include nitroprusside, nicardipine, and phentolamine. Once the acute hypertensive crisis has resolved, transition to oral  $\alpha$ -adrenergic blockers is indicated. Phenoxybenzamine is the most commonly used drug and is started at low doses (5–10 mg three times daily) and titrated to the maximum tolerated dose (usually 20–30 mg daily). Once alpha blockers have been initiated, beta blockade can safely be used and is particularly indicated

for ongoing tachycardia. Liberal salt and fluid intake helps expand plasma volume and treat orthostatic hypotension. Once blood pressure is maintained  $< 160/100$  mm Hg with moderate orthostasis, it is safe to proceed to surgery. If blood pressure remains elevated despite treatment with alpha blockade, addition of calcium channel blockers, angiotensin receptor blockers, or angiotensin-converting enzyme inhibitors should be considered. Diuretics should be avoided because they exacerbate orthostasis.

111. The answer is B.

(Chap. 48) This patient has the classic triad of symptoms for pheochromocytoma: headaches, palpitations, and profuse sweating. When this triad of symptoms is found in association with hypertension, pheochromocytoma is the most likely diagnosis. Differential diagnosis for pheochromocytoma includes panic disorder, essential hypertension, cocaine or methamphetamine abuse, carcinoid syndrome, intracranial mass, clonidine withdrawal, and factitious disorder. Although episode hypertension is classically described in association with pheochromocytoma, many patients have sustained hypertension that may be difficult to treat. In addition, 5–15% of individuals may present with normal blood pressure (*WM Manger: J Clin Hypertens* 4: 62, 2002). The patient also exhibits significant orthostatic changes in blood pressure, which is a common finding in pheochromocytoma. Interestingly, there is a case report of treatment with paroxetine unmasking symptoms of pheochromocytoma (*MA Seeler et al: Ann Intern Med* 126: 333, 1997). The cornerstone of diagnosis of pheochromocytoma is the documentation of elevated levels of urine and plasma catecholamines. The usual diagnostic algorithm includes the measurement of vanillylmandelic acid, catecholamines, and fractionated metanephrines in a 24-h urine collection or plasma sample. These tests should be greater than two to three times the upper limit of normal. If metanephrines are elevated, a CT scan or MRI of the chest, abdomen, and pelvis is performed with contrast to localize the site of the pheochromocytoma. Nuclear imaging with  $^{123}\text{I}$  or  $^{131}\text{I}$  metaiodobenzylguanidine (MIBG) can also be utilized for localization of the pheochromocytoma after biochemical testing has confirmed elevated levels of catecholamines. Given the classic symptoms of this patient, panic attack is a diagnosis of exclusion because the missed diagnosis of pheochromocytoma increases the risk of adverse outcomes, including death and stroke. Carcinoid syndrome is diagnosed with 24-h urine testing for 5-HIAA, but it is unlikely in this patient because carcinoid syndrome is not associated with hypertension.

112. The answer is E.

(Chap. 45) Thyroid nodules are found in 5% of patients. Nodules are more common with age, in women, and in

iodine-deficient areas. Given their prevalence, the cost of screening, and the generally benign course of most nodules, the choice and order of screening tests have been very contentious. A small percentage of incidentally discovered nodules represent thyroid cancer, however. A TSH should be the first test to check after detection of a thyroid nodule. Most patients will have normal thyroid function tests. In the case of a normal TSH, fine-needle aspiration or ultrasound-guided biopsy can be pursued. If the TSH is low, a radionuclide scan should be performed to determine if the nodule is the source of thyroid hyperfunction (a “hot” nodule). In this case, this is the best course of action. “Hot” nodules can be treated medically, resected, or ablated with radioactive iodine. “Cold” nodules should be further evaluated with a fine-needle aspiration. Four percent of nodules undergoing biopsy will be malignant, 10% are suspicious for malignancy, and 86% are indeterminate or benign.

113. and 114. The answers are E and E.

(Chap. 46) In patients with a nonmetastatic carcinoid, surgery is the only potentially curative therapy. The extent of surgical resection depends on the size of the primary tumor because the risk of metastasis is related to the size of the tumor. Symptomatic treatment is aimed at decreasing the amount and effect of circulating substances. Drugs that inhibit the serotonin 5-HT<sub>1</sub> and 5-HT<sub>2</sub> receptors (methysergide, cyproheptadine, ketanserin) may control diarrhea but not flushing. 5-HT<sub>3</sub> receptor antagonists (ondansetron, tropisetron, alosetron) control nausea and diarrhea in up to 100% of these patients and may alleviate flushing. A combination of histamine H<sub>1</sub> and H<sub>2</sub> receptor antagonists may control flushing, particularly in patients with foregut carcinoid tumors. Somatostatin analogues (octreotide, lanreotide) are the most effective and widely used agents to control the symptoms of carcinoid syndrome, decreasing urinary 5-HIAA excretion and symptoms in 70–80% of patients. Interferon  $\alpha$ , alone or combined with hepatic artery embolization, controls flushing and diarrhea in 40–85% of these patients. Pheoxybenzamine is an  $\alpha_1$ -adrenergic receptor blocker used in the treatment of pheochromocytoma.

Carcinoid crisis is a life-threatening complication of carcinoid syndrome. It is most common in patients with intense symptoms from foregut tumors or markedly

high levels of urinary 5-HIAA. The crisis may be provoked by surgery, stress, anesthesia, chemotherapy, or physical trauma to the tumor (biopsy or, in this case, physical compression of liver lesions). These patients develop severe typical symptoms plus systemic symptoms such as hypotension and hypertension with tachycardia. Synthetic analogues of somatostatin (octreotide, lanreotide) are the treatment of choice for carcinoid crisis. They are also effective in preventing crises when administered before a known inciting event. Octreotide, 150–250  $\mu\text{g}$  subcutaneously, every 6–8 h should be started 24–48 h before a procedure that is likely to precipitate a carcinoid crisis.

115. The answer is A.

(Chap. 47) This patient’s clinical scenario is most consistent with MEN 1, or the “3 Ps”: parathyroid, pituitary, and pancreas. MEN 1 is an autosomal dominant genetic syndrome characterized by neoplasia of the parathyroid, pituitary, and pancreatic islet cells. Hyperparathyroidism is the most common manifestation of MEN 1. The neoplastic changes affect multiple parathyroid glands, making surgical care difficult. Pancreatic islet cell neoplasia is the second most common manifestation of MEN 1. Increased pancreatic islet cell hormones include pancreatic polypeptide, gastrin, insulin, vasoactive intestinal peptide, glucagons, and somatostatin. Pancreatic tumors may be multicentric, and up to 30% are malignant, with the liver the first site of metastases. The symptoms depend on the type of hormone secreted. Elevations of gastrin result in the Zollinger–Ellison syndrome (ZES). Gastrin levels are elevated, resulting in an ulcer diathesis. Conservative therapy is often unsuccessful. Insulinoma results in documented hypoglycemia with elevated insulin and C-peptide levels. Glucagonoma results in hyperglycemia, skin rash, anorexia, glossitis, and diarrhea. Elevations in vasoactive intestinal peptide result in profuse watery diarrhea. Pituitary tumors occur in up to half of patients with MEN 1. Prolactinomas are the most common. The multicentricity of the tumors makes resection difficult. Growth hormone-secreting tumors are the next most common, with ACTH- and corticotropin-releasing hormone (CRH)-secreting tumors being more rare. Carcinoid tumors may also occur in the thymus, lung, stomach, and duodenum.

# INDEX

Bold number indicates the start of the main discussion of the topic; numbers with “f” and “t” refer to figure and table pages.

- AA. *See* Aplastic anemia
- “ABCD rules” for melanoma, 426
- Abciximab, 269t
- action mechanism of, 268, 692, 714
  - drug-induced thrombocytopenia and, 227
  - for MI, 269
- Abnormal hemoglobins. *See* Structural hemoglobinopathies
- ABO antigens/antibodies, 143–144
- genes determining, 144
- Abscopal effect, 39
- ABVD. *See* Doxorubicin, bleomycin, vinblastine, and dacarbazine
- Acanthocytosis, peripheral blood smear of, 61f
- Acanthosis nigricans, 607
- ACE. *See* Angiotensin-converting enzyme
- Acetaminophen, 653
- for pain intervention, 405
- Acquired abnormality of cobalamin metabolism, 104
- Acquired disorders of platelet function, 231
- Acquired hemoglobinopathies, 84, 93
- Acquired inhibitor, of coagulation factors, 244
- Acral lentiginous melanoma, 423, 423f
- ACS. *See* American Cancer Society
- ACTH. *See* Adrenocorticotropic hormone
- Actinic keratoses, 430
- skin lesion of, 429f
- Actinomycin D, 355t
- Activated partial thromboplastin time (aPTT), 29, 698, 723
- phospholipid composition of, 30
  - prolongation of, 235
- Active surveillance
- for pancreatic cancer, 502
  - for prostate cancer, 518
    - case selection for, 518
    - 10-year survival rates for, 518  - for testicular cancer, 526
- Acute blood loss
- anemia from, 11, 126–127
    - treatment for, 127  - clinical/pathophysiologic stages of, 127
  - vascular instability from, 11
- Acute chest syndrome
- management of, 88
  - sickle cell anemia and, 86
- Acute erythroleukemia. *See* Erythroleukemia, acute
- Acute hemolytic reaction, to transfusion, 147–148
- Acute lung injury, transfusion-related, 149
- Acute lymphoblastic leukemia (ALL), 100, 297
- peripheral blood smear of, 66f, 191f
- Acute lymphoid leukemia (ALL)
- classification of, 183t
  - etiology of, 184
  - evaluation of, 189, 690, 711
  - genetic abnormalities of, 187
- Acute megakaryoblastic leukemia, 167
- Acute myeloid leukemia (AML), **166**, 661
- cell morphology of, 169f
  - chromosomal analyses of, 168
  - classification of, 167–168
    - by FAB, 167, 167t
    - molecular, 168
    - by WHO, 167, 167t  - clinical presentation of, 168–171
    - hematologic findings, 169–170
    - physical findings, 169
    - pretreatment evaluation, 170–171
    - symptoms, 168–169  - diagnosis of, 696–697, 721
  - epidemiology/risk factors for, 697–698, 722
  - etiology of, 166–167
    - chemical/other exposure and, 166–167
    - drugs and, 167
    - hereditary, 166
    - radiation and, 166  - hematopoietic stem cell transplantation for, 395
  - incidence of, 166
  - infectious complications and, 173
  - initial diagnostic evaluation/management of, 170t
  - peripheral blood smear of, 65f
  - prognostic factors of, 171–172
    - chromosome findings, 171  - supportive care for, 172–173
  - treatment of, 172–175
    - algorithm for, 172f
    - anthracycline therapy, 171
    - blood bank support, 173
    - chemotherapy induction, 171–172
    - fever and, 173
    - new agents for, 174t
    - postremission therapy, 174–175
    - relapse, 175
    - SCT, 175
- Acute necrotizing myopathy, 638
- Acute posthemorrhagic anemia (APHA)
- clinical/pathophysiologic stages of, 127
  - diagnosis of, 127
- Acute promyelocytic leukemia (APL), 240
- peripheral blood smear of, 65f
  - treatment of, 696, 720–721
- Acyclovir, for herpes viruses, 385t
- ADAMTS13 activity
- HUS and, 230, 231, 654
  - TTP and, 230
- Addison’s disease, anemia and, 79
- Adenoacanthoma, 535
- Adenocarcinoma, 439
- diagnosis of, 688, 708
  - esophageal cancer as, 472
  - as malignant small intestine tumors, 486
- Adenomas
- as benign small intestine tumors, 485–486
  - bronchial, 457
  - familial cancer syndromes and, 286
- Adenomatous polyposis coli (APC)
- function of, 286
  - germline/somatic mutations in, 288f
- Adenosine diphosphatase (ADPase), 265
- Adenosine triphosphate (ATP), 112
- Adenosquamous carcinoma, 535
- Adjuvant therapy
- for adrenocortical tumors, 618
  - for breast cancer, 465
    - suggested approaches for, 466t  - for HCC, 494
  - for melanoma, 428
  - for NSCLC, 452–453, 452t
  - for pancreatic cancer, 503, 503f
  - for soft tissue sarcoma, 543
- ADPase. *See* Adenosine diphosphatase
- Adrenal cortical tumors, 600
- Adrenal insufficiency, 687, 707
- from megestrol, 652
  - serum cortisol and, 652
  - treatment for, 652
  - as unnoticeable, 651
- Adrenalectomy, for pheochromocytoma, 605
- Adrenocortical tumors, **615**
- clinical features of, 617
  - Cushing’s syndrome and, 615, 617
  - diagnostic approach to, 617–618
  - examination for, 618
  - FNA for, 618
  - genetic considerations for, 617
  - imaging for, 618
  - incidence/etiology of, 615, 617
  - predisposition to, 617
  - staging for, 618
  - German Adrenocortical Cancer Registry on, 618

- Adrenocortical tumors (*Cont.*):  
 survival rate for, 618  
 treatment for, 618–619  
 adjuvant therapy for, 618  
 surgery, 618
- Adrenocorticotrophic hormone (ACTH), 440, 599
- Adult T cell leukemia (ATL), 185, 200–201  
 diagnosis of, 200  
 peripheral blood smear of, 66f, 200f
- Advanced care planning  
 communication and, 402  
 document types needed for, 402  
 durable attorney and, 402  
 legal aspects of, 402–403  
 practices and, 402  
 steps in, 403t
- Advisory Committee on Immunization  
 Practices, 40
- AFP. *See*  $\alpha$ -Fetoprotein
- African Americans  
 anemia and, 12  
 multiple myeloma in, 207
- Aggrenox  
 dosing for, 268  
 for stroke prevention, 268  
 for TIA, 267
- AHSP. *See*  $\alpha$ -Hemoglobin-stabilizing protein
- AICAR. *See* Aminoimidazole carboxamide ribonucleotide
- AIHA. *See* Autoimmune hemolytic anemia
- Airway obstruction, 651f  
 cause of, 650  
 diagnosis of, 650  
 as oncologic emergency, 650  
 treatment for, 650
- AJCC. *See* American Joint Commission for Cancers
- AL amyloidosis, 217, **219**  
 clinical signs of, 221f  
 diagnosis of, 219–220  
 etiology/incidence of, 219  
 laboratory features of, 220f  
 LCs in, 220  
 pathology/clinical features of, 220–221  
 rapid progression of, 220  
 supportive care for, 222  
 treatment of, 221–222
- Alemtuzumab, 194, 299t, 656
- Alfimeprase, 282
- ALG. *See* Antilymphocyte globulin
- ALK. *See* Anaplastic lymphoma kinase
- ALL. *See* Acute lymphoblastic leukemia;  
 Acute lymphoid leukemia
- Allergic reactions, to blood transfusion, 148–149
- Alloantibodies, 143, 144–145  
 FVIII/FIX and, 238
- Allogeneic stem cell transplant, 371, 389  
 for CML, 177, 395  
 donor of, 178  
 GVHD development from, 179  
 patient of, 177–178  
 posttransplantation treatment of, 179  
 preparative regimens and, 178–179  
 recipients of, blood cell renewal, 4  
 umbilical cord blood and, 178
- Alloimmunization, 143  
 transfusion therapy and, 149–150
- All-trans retinoic acid (ATRA), 299t, 304, 365
- Alopecia, as chemotherapy complication, 370
- Alpha heavy chain disease (Selig Mann's disease), 215–216
- Alprazolam, 410
- Alteplase  
 anistreplase v., 281  
 domains of, 281, 281f  
 for MI, 281
- Altretamine, 354t, 359
- Alzheimer's Association, 413
- Amantadine, 386t
- American Academy of Dermatology, 425
- American Cancer Society (ACS), 339, 413, 425, 463, 513  
 Pap smear recommendation of, 690, 711
- American College of Physicians, 330
- American Joint Commission for Cancers (AJCC), 325, 491, 618  
 on melanoma, 423–424  
 soft tissue sarcoma staging by, 542t  
 thyroid cancer staging by, 572, 573t
- American Society of Clinical Oncology, 463
- American Urological Association (AUA)  
 Symptom Index, for benign prostate disease, 522
- Aminoglutethimide, 619
- Aminoimidazole carboxamide ribonucleotide (AICAR), 99
- Amiodarone, for AL amyloidosis, 222
- Amitriptyline, 327
- AML. *See* Acute myeloid leukemia
- Amniotic fluid embolism, 255
- Amoxicillin, 375
- Amphotericin B, 380  
 antifungal therapy and, 384  
 voriconazole v., 384
- Ampulla of Vater carcinoma, 498
- Amyloid fibril proteins  
 formation of, 218  
 precursors of, 218t
- Amyloid precursor protein (APP), 217
- Amyloidosis, **217**. *See also* AL amyloidosis  
 biochemical nature of, 217  
 clinical suspicion of, 219f  
 clinical syndromes of, 218  
 diagnosis/treatment of, 218  
 general principles of, 217–219  
 supportive care for, 222
- Anagrelide, 163
- Anaphylactic reaction, to blood transfusion, 149
- Anaplastic astrocytoma, 549
- Anaplastic large T/null cell lymphoma  
 diagnosis of, 201  
 systemic symptoms of, 201  
 treatment of, 201
- Anaplastic lymphoma kinase (ALK), 201
- Anaplastic thyroid cancer (ATC), 571, 577  
 chemotherapy for, 577
- Anastrozole, 363
- Androgen-depletion syndrome, 519  
 clinical trial for, 520  
 intermittent hormone therapy for, 520  
 outcomes of, 520–521  
 survival rates of, 520
- Anemia, **11**. *See also* Hypometabolic state  
 anemia; Hypoproliferative anemia  
 from acute blood loss, 11, 126–127  
 treatment for, 127
- Addison's disease and, 79
- African Americans and, 12  
 bone marrow response to, 17t  
 from chemotherapy, 368  
 classification of, 13, 18–20, 18f  
 blood loss/hemolytic anemia, 19–20  
 hemolytic disease, 19  
 hypoproliferative anemia, 18–19  
 initial/functional, 18  
 iron-deficiency, 19  
 maturation disorders, 19  
 clinical presentation of, 11–16  
 signs/symptoms of, 11–12  
 EPO levels influencing, 11, 11f  
 from folate deficiency, 79  
 laboratory evaluation for, 12–13, 13t  
 likelihood/severity scale of, 11  
 liver disease and, 79  
 mechanism clues to, 12  
 multiple myeloma and, 209  
 peripheral blood smear for, 13, 685, 706  
 physical examination for, 12  
 reticulocyte count for, 13, 15–16, 686, 706  
 treatment of, 20  
 WHO definition of, 11
- Anemia of chronic disease, 77
- Anemia of inflammation, 70
- ANF. *See* Atrial natriuretic factor
- Angina, clopidogrel for, 267
- Angiocentric lymphoma, 201
- Angioimmunoblastic T cell lymphoma, 201
- Angiomas, as benign small intestine tumors, 486
- Angiotensin-converting enzyme (ACE), 150
- Animal fats, colorectal cancer and, 478–479
- Anisocytosis, 13, 57

- Anistreplase, 280–281  
administration of, 280  
alteplase v., 281
- Ann Arbor staging system, 325  
for Hodgkin's disease, 190t
- Anoikis, 352
- ANP. *See* Atrial natriuretic peptide
- Anthracycline therapy, 577  
for AML, 171
- Antiandrogens, 520
- Antiangiogenic therapy, 314–317  
randomized trials for, 315
- Antibacterial therapy  
benefits of, 384  
for cancer patient infections,  
383–384  
initial regimen for, 383, 384  
randomized trials for, 384  
resistance pattern and, 384
- Antibiotics  
antitumor, 360–361  
for infection, 374
- Antibody. *See also* Human antibody infusion  
reactions  
ABO, 143–144  
allo-, 143, 144–145, 238  
anti-C5, 126, 126f  
anti-Hu, 634  
antiphospholipid testing for, 30–31  
antityroxine as, 608  
anti-Yo, 636  
auto-, 143  
biologic therapy and, 372  
Donath-Landsteiner, 123, 145  
insulin resistance by, 607–608  
molecules of, 205  
insulin resistance from, 607–608  
monoclonal, 485  
NMDA receptor, 633f  
nonparaneoplastic neurologic disorders  
associated with, 635t  
PNDs associated with, 635t  
serum, 102–103
- Anti-C5 antibody  
PNH treatment and, 126  
therapeutic efficacy of, 126f
- Anticoagulants, 264, **269**  
oral, 276–279  
parenteral, 269–276
- Anticoagulation, 259–261  
complications of, 260  
duration of, 260–261  
fondaparinux and, 259–260  
guidelines for, 261  
hospital stay during, 260  
LMWH and, 259  
UFH and, 259  
warfarin and, 260
- Antifibrinolytic drugs, 233  
DIC and, 242–243
- Antifibrinolytic drugs (*Cont.*):  
for hemophilia, 238  
therapeutic monitoring of, 672–675t
- Antifungal therapy  
amphotericin B and, 384  
for cancer patient infections, 384–385
- Anti-Hu antibodies, 634
- Antilymphocyte globulin (ALG), 133
- Antimetabolites, 361–362
- Antiphospholipid antibody testing, 30–31
- Antiplatelet drugs, 264, **265**  
action site of, 266f  
new agents for, 269  
role of, 265  
target of, 265  
therapeutic monitoring of, 672–675t
- Antithrombin, 24
- Antithrombotic drugs  
classification of, 265t  
components of, 264  
therapeutic monitoring of, 672–675t
- Antithrombotic mechanisms, 24–25  
physiologic pathways for, 24f
- Antithymocyte globulin (ATG), 138  
horse/rabbit, 135
- Antitumor antibiotics, 360–361
- Antityroxine antibodies, hypothyroidism and,  
608
- Antiviral therapy  
for cancer patient infections, 385, 386t  
for herpes viruses, 385, 385t
- Anti-Yo antibodies, cerebellar degeneration  
and, 636
- Antrectomy, 589
- Anus cancers, **487**  
development of, 487  
treatment for, 487–488
- Antzemet. *See* Dolasetron
- APC. *See* Adenomatous polyposis coli
- APECED. *See* Autoimmune  
polyendocrinopathy–candidiasis–  
ectodermal dystrophy
- APHA. *See* Acute posthemorrhagic anemia
- APL. *See* Acute promyelocytic leukemia
- Aplastic anemia (AA), 72, **128**, 700  
biopsy of, 132f  
of bone marrow, 64f  
bone marrow failure and, 125  
classification of, 129t  
clinical features of, history/physical  
examination, 133  
definition of, 128–129  
diagnosis for, 134  
epidemiology of, 129  
chemicals, 130, 130t  
constitutional disorders, 131  
drug injury, 132–133  
drugs, 130–131, 130t  
immune-mediated injury, 133  
immunologic diseases, 131
- Aplastic anemia (AA), epidemiology of (*Cont.*):  
infection, 131  
PNH, 131  
pregnancy, 131  
radiation, 130  
etiology of, 129–130  
hematopoietic stem cell transplantation  
for, 394  
laboratory studies for  
ancillary studies, 134  
blood smear, 133  
bone marrow smear, 133  
prognosis for, 134  
supportive care for, 136  
treatment for, 134–136, 700, 726  
hematopoietic stem cell transplantation,  
134–135  
immunosuppression, 135
- Aplastic crisis, 94, 113
- Apo ferritin, 71
- Apoptosis, 10, **305**, 352  
cancer cell biology and, 305–307  
death receptors and, 306–307  
preclinical studies on, 306–307  
drug induced, 307  
induction of, 305  
protein regulation and, 305  
tumor cell evolution and, 305
- APP. *See* Amyloid precursor protein
- Appendiceal carcinoids, 584
- aPTT. *See* Activated partial thromboplastin  
time
- ara-C. *See* Cytosine arabinoside
- Argatroban  
action mechanism of, 692, 714  
hirudin/bivalirudin v., 275  
for HIT, 228, 276  
INR for, 276
- Arginine vasopressin (AVP), 440
- Arsenic trioxide, 174, 358t
- Arterial blood gases, 256
- Arterial thrombosis  
platelet role in, 265  
platelet/fibrin composition of, 264  
venous thrombosis v., 264  
vessel wall disruption and, 265
- Ascorbic acid, 90
- Asparaginase, 357t, 362, 656
- Aspergillus* infection, 381–382  
outbreaks of, 386  
presentation of, 381  
treatment of, 384
- Aspirin, 27, 163, 336  
action mechanism for, 265–266  
dosage of, 266  
indications for, 266  
for MI, 266  
resistance to, 266  
side effects of, 266  
use of, 698, 723

- Asplenism. *See* Hyposplenism
- Astrocytomas, 550f  
gliomatosis cerebri as, 551  
high-grade, 551  
alternative treatment approach to, 551  
low-grade, 550  
median overall survival rate of, 550  
pathogenesis model of, 550f  
primary brain tumors and, 549–551  
WHO grading system for, 549
- Asymmetric cell division, 3
- ATBC. *See*  $\alpha$ -Tocopherol/ $\beta$ -carotene Lung Cancer Prevention Trial
- ATC. *See* Anaplastic thyroid cancer
- ATG. *See* Antithymocyte globulin
- Ativan. *See* Lorazepam
- ATL. *See* Adult T cell leukemia
- ATP. *See* Adenosine triphosphate
- ATRA. *See* All-trans retinoic acid
- Atraumatic endoscopic surgery, 612
- Atrial natriuretic factor (ANF), 440
- Atrial natriuretic peptide (ANP), 625
- AUA. *See* American Urological Association
- Auer rods, AML cell morphology of, 169f
- Autoantibodies, 143
- Autocrine growth factors, lung cancer and, 442
- Autoimmune hemolytic anemia (AIHA)  
CAD as, 123–124  
clinical features of, 123  
Coombs-negative, 123  
medical emergency of, 123  
pathophysiology of, 122–123  
PCH as, 123  
treatment of, 123
- Autoimmune insulin syndrome, with hypoglycemia, 608
- Autoimmune polyendocrinopathy-candidiasis-ectodermal dystrophy (APECED), 606
- Autologous stem cell transplant, 389  
for CML, 180  
GVT effect lacking from, 389
- Autonomic dysfunction, 634
- Avastin. *See* Bevacizumab
- Avoidance bias, 712
- AVP. *See* Arginine vasopressin
- Axillary adenopathy CUP treatment, 566
- 5-Azacytidine, 88, 141, 356t, 365
- Azathioprine, 124, 138, 356t
- Aztreonam, for AML, 173
- Azurophil granules, 43  
defensins and, 43
- B cell chronic lymphoid leukemia  
diagnosis of, 192  
differential diagnosis of, 192  
treatment for, 192–194
- B cell differentiation, from normal to lymphoma, 186–187, 187f
- B cell polymphocytic leukemia, 199
- BAC. *See* Bronchioalveolar carcinoma
- Bacille Calmette-Guérin (BCG), 52t
- Bacterial infection, multiple myeloma susceptibility to, 208
- Baker's cyst, 255
- Basal cell carcinoma (BCC), 428  
clinical presentation of, 429–430  
natural history of, 430  
skin lesion of, 429f  
treatment for, 430–431
- Basophil  
morphology of, 45f  
peripheral blood smear of, 63f
- Basophilic stippling, 57, 121
- BCC. *See* Basal cell carcinoma
- BCG. *See* Bacille Calmette-Guérin
- BCPT. *See* Breast Cancer Prevention Trial
- BCR-ABL oncogene product, 297–300
- Beckwith-Wiedemann syndrome, 617
- Benign prostate disease  
cystoscopy for, 522  
surgical approaches to, 522
- Benign prostatic hypertrophy (BPH), 513
- Benzene, 130  
exposure to, 166–167
- Benzotropine, 411
- BEP. *See* Cisplatin, bleomycin, etoposide
- Bernard-Soulier syndrome, 231
- Bethesda units (BU), 238
- Bevacizumab (Avastin), 299t, 455, 485, 534, 656  
action mechanism of, 315–316, 315t  
clinical use of, 317  
delivery of, 316  
randomized clinical trials for, 315t  
side effects of, 316  
success of, 317  
VEGF inhibition by, 317
- Bexarotene, 358t
- Bicalutamide, 520  
withdrawal response of, 521
- Biliary obstruction. *See* Malignant biliary obstruction
- Biologic therapy, 343  
autologous T cell manipulation and, 371  
bell-shaped dose-response curve for, 370  
cancer treatment and, 370–373  
goal of, 370  
immune mediators/antitumor effects of, 371–373  
antibodies and, 372  
cytokines and, 372–373
- Biopsy  
of AA, 132f  
of bone marrow, 132f  
for cancer treatment, 345  
for cobalamin deficiency, 102  
core-needle as, 345  
excisional as, 345
- Biopsy (*Cont.*):  
fine needle aspiration as, 345, 570, 618  
gastric, 102  
incisional as, 345  
of lymph nodes, 35  
of melanoma, 426–427  
open-lung, 382  
prostate, 513, 514  
for soft tissue sarcoma, 541
- Bisphosphonate zoledronate, 521
- Bivalirudin  
heparin v., 276  
hirudin/argatroban v., 275t
- Bladder cancer, **504**  
cigarette smoking and, 504  
clinical presentation/diagnosis of, 505–506  
endoscopic evaluation for, 506  
epidemiology of, 504  
hematuria and, 505  
incidence of, 504  
management of, 508t  
pathogenesis of, 505  
pathology of, 504–505  
polychronotropism exhibited by, 504  
survival rate for, 507  
TNM staging of, 504, 505f  
transitional cell origin of, 504  
treatment for, 506–507  
chemotherapy, 507–508  
cystectomy, 506  
endoscopic resection, 505  
intravesical, 506  
invasive disease, 506–507  
metastatic disease, 507  
superficial disease, 506  
surgery, 507
- Bladder dysfunction, 659
- Blast crisis, treatment of, 181
- Blastic skeletal metastases, PSA elevation and, 566
- Bleeding/thrombosis, **22**  
bleeding history and, 25–27  
clinical presentation of, 25–27  
hemophilia and, 237  
from heparin, 272  
herbal supplements associated with increased, 27t  
history of, 28–29  
ITP and, 228  
laboratory evaluation for, 29  
antiphospholipid antibody testing, 30–31  
mixing studies, 30  
platelet function measures, 31  
screening assays, 29–30  
specific factor assays, 30  
from LMWH, 274  
medications/dietary supplements influencing, 27  
risk factors for, 28f, 28t  
tonsillectomy and, 26–27

- Bleeding/thrombosis (*Cont.*):  
 underlying systemic diseases influencing, 27–28  
 from warfarin, 278
- Bleomycin, 355t, 454, 539  
 adverse effect of, 382  
 pulmonary damage from, 654  
 side effects/toxicity of, 360
- Blood cells  
 peripheral collection of, 391  
 regulatory mechanisms of, 4
- Blood components, **145**  
 characteristics of, 146t  
 cryoprecipitate as, 147  
 FFP as, 147  
 plasma derivatives as, 147  
 platelets as, 146–147  
 PRBC as, 146  
 whole blood as, 146
- Blood fractionation industry  
 advances in, 237  
 diseases/infection influencing, 237
- Blood group antigens/antibodies  
 ABO antigens/antibodies as, 143–144  
 alloantibodies as, 144–145  
 Rh system as, 144
- Blood-tumor barrier, brain metastasis and, 557
- BMF. *See* Bone marrow failure
- Bmi-1 gene, absence of, 6
- BMSCs. *See* Bone marrow stromal cells
- BMT. *See* Bone marrow transplantation
- BNP. *See* Brain natriuretic peptide
- Body fluids, reference range of, 683t
- Bohr effect, 11
- Bombay phenotype (O<sub>h</sub>), 144
- Bone marrow  
 AA smear of, 133–134  
 anemia response and, 17t  
 aplastic anemia of, 64f  
 biopsy of, 132f  
 collection of, 390  
 differential cell counts of, 678t  
 of erythroid hyperplasia, 17f, 64f  
 examination of, 17  
 lymphoma in, 64f  
 megaloblastic anemia and, 100–101, 101f  
 metastatic cancer in, 64f  
 myelofibrosis of, 62f  
 of myeloid hyperplasia, 17f, 64f  
 normal smear of, 17f, 64f  
 radiation therapy and, 349  
 stem cell proliferation in, 3  
 WM and, 214
- Bone marrow failure (BMF), PNH/AA and, 125
- Bone marrow iron stores evaluation, iron laboratory studies as, 74–75
- Bone marrow stromal cells (BMSCs), 207
- Bone marrow transplantation (BMT), 88, 94, 126, 388  
 for CML, 178  
 for diffuse large B cell lymphoma, 198  
 late complications of, 693, 714
- Bone metastasis, 307, 692, 713  
 pain from, 545, 685, 705  
 peripheral bone smear of, 64f  
 treatment for, 545–546
- Bone sarcomas, **543**  
 chondrosarcoma and, 544–545  
 classification of, 543  
 benign tumors, 543  
 malignant tumors, 543  
 Musculoskeletal Tumor Society Staging System for, 543  
 Ewing's sarcoma and, 545  
 incidence/epidemiology of, 543  
 osteosarcomas and, 543–544  
 staging system for, 544t
- Bone scan radionuclide, 515, 546
- Bortezomib, 299t, 365, 369  
 for AL amyloidosis, 222  
 for multiple myeloma, 213
- Bourneville's disease. *See* Tuberous sclerosis
- BPH. *See* Benign prostatic hypertrophy
- Brachial plexitis, 638
- Brachytherapy, 346  
 for brain/cervix cancer, 348  
 improvements in, 518  
 for prostate cancer, 517–518  
 as radiation therapy delivery, 348  
 toleration of, 518
- Brain masses, 380
- Brain natriuretic peptide (BNP), 218
- Brain tumors. *See also* Primary brain tumors  
 benign types of, 555  
 clinical features of, 547–548  
 hereditary syndromes associated with, 549t  
 ICP from, 548  
 laboratory examination for, 548  
 as metastatic, 557f  
 blood-tumor barrier and, 557  
 chemotherapy for, 558  
 frequency of, 557t  
 without known primary tumor, 557–558  
 mechanisms of, 556–557  
 radiation therapy for, 558  
 radiologic appearance of, 557  
 surgery for, 558  
 tissue diagnosis needed for, 558  
 treatment for, 558  
 neuroimaging for, 548  
 PET for, 548  
 progressive focal neurologic deficits from, 547  
 seizures from, 548  
 treatment for, 548
- Brainstem encephalitis, 634
- BRCA-1 gene mutation, 459
- BRCA-2 gene mutation, 459
- Breast cancer, **459**  
 chemoprevention of, 336  
 diet role in, 460  
 epidemiology of, 460–461  
 radiation, 461  
 exogenous hormone role in, 460–461  
 genetic considerations of, 288–289, 340, 459–460  
 HER2/*neu* target in, 300  
 HRT and, 460–461  
 international incidence variation of, 460  
 late effects/consequences of, 661–662  
 in men, 470  
 metastasis of, 556  
 patient follow-up of, 470, 470t  
 prognosis of, 700, 725  
 radiation therapy risk increase of, 349  
 risk factors for, 698, 722–733  
 screening for, 340, 463  
 staging for, 463, 464t  
 5-year survival rate and, 465t  
 treatment for, 463–470  
 adjuvant therapy, 465, 466t  
 breast conservation, 463, 465  
 chemotherapy, 468–469  
 DCIS, 469–470  
 endocrine therapy, 468, 468t  
 estrogen/progesterone receptor status, 465  
 extensive intraductal component of, 465  
 histologic classification, 466  
 lobular neoplasia, 470  
 molecular changes, 466  
 neoadjuvant chemotherapy, 467  
 noninvasive, 469  
 prevention, 469  
 prognostic variables, 465  
 radiation therapy, 467–468  
 stage III, 469  
 systemic therapy, 467–468  
 tumor growth rate, 465–466
- Breast Cancer Prevention Trial (BCPT), 469
- Breast mass  
 abnormal mammogram and, 462  
 benign, 463  
 diagnosis of, 462f  
 palpation of, 461–462  
 algorithm for, 461f  
 pregnancy and, 700, 726  
 in pregnant/lactating woman, 463
- Breast self-examination (BSE), 340, 461  
 recommendation on, 700, 725
- Brief Pain Inventory, 404
- Bronchial adenomas, 457
- Bronchial carcinoids  
 classification of, 585  
 prognosis of, 585
- Bronchioalveolar carcinoma (BAC), 441
- BSE. *See* Breast self-examination
- BU. *See* Bethesda units



- Budd–Chiari syndrome, 249
- Burkitt's leukemia/lymphoma  
 clinical forms of, 198  
 diagnosis of, 198  
 diffuse large B cell lymphoma v., 199  
 EBV associated with, 185  
 in lymph node, 67f  
 peripheral blood smear of, 66f, 198f  
 TLS and, 652  
 treatment of, 199
- Busulfan, 149, 390, 394  
 pulmonary damage from, 654  
 side effects of, 359
- Butyrate, 83
- CA-125  
 ovarian cancer elevation of, 531  
 screening test limitation of, 531
- CAD. *See* Cold agglutinin disease
- Calcitonin, for HHM, 625
- CALGB. *See* Cancer and Leukemia Group B
- Camptothecin, 361
- Campylobacter jejuni*, 185
- Canadian Task Force on Preventive Health Care, 339
- Cancer  
 in bone marrow, 64f  
 cell abnormalities in, 295–297  
   genetic lesions found in, 295–296  
 characteristic features of, 294  
 clonal origin/multistep nature of, 284–285  
   colon carcinoma, 285f  
   malignancy development, 285f  
 death from, 321, 321f, 321t  
   tumor sites and, 323t  
   women v. men, 322f  
 disease management/treatment  
   complications of, 326–328  
   reversible symptoms of, 326  
   treatment response and, 326–328  
 epigenetic regulation of gene expression in, 292  
 gene expression/mutational profiling in, 292–293  
 incidence of, 320–321, 321t  
   in racial/ethnic groups, 323t  
   worldwide, 324f  
 late effects of, 658t  
   consequences of, 661–662  
   drug toxicities/radiation therapy toxicity, 658  
   organ system complications, 659–660  
   outlook on, 662  
   second malignancies as, 660–661  
   surgery and, 658  
 long-term follow-up/late complications of, 328, **657**  
 molecularly targeted agents for treatment of, 299t
- Cancer (*Cont.*):  
 multistep process of, 7  
 oncogenes in, 289, 290t  
 pathologic staging for, 325  
 patient management and, 324–331  
   diagnosis, 324  
   disease extent/prognosis, 324–325  
 from polyps, 478  
 predisposition to, 694, 716  
 recurrence of, 328  
 risk factor for, 321  
   smoking as, 332  
 self-renewal capacity's similarity with, 7  
 seriousness of, 320–322  
 staging for  
   clinical/pathological, 325  
   information obtained from, 325  
 stem cell organization of, 7  
 supportive care for, 328–331  
   death and dying and, 330–331  
   effusion management and, 329  
   end-of-life decisions and, 331  
   nausea management and, 329  
   nutrition management and, 330  
   pain management and, 328–329  
   psychosocial support and, 330  
   survivorship issues from, 657  
   treatment plan design for, 326  
   tumor burden and, 325  
   tumor markers for, 327t  
   viruses in, 292  
   around the world, 323–324
- Cancer and Leukemia Group B (CALGB), 174
- Cancer cell biology, **294**  
 aberrant survival pathways in, 305  
   therapeutic strategies for, 306f  
 apoptosis and, 305–307  
 epigenetic modification and, 302–305, 303f  
 gene transcription alteration in, 302–305  
 histone acetylases and, 303  
 oncogenic pathway/treatment mechanism for, 300  
 p53 and, 296  
 phenotypic characteristics of, 295t  
 regulated death process and, 352, 353f  
 signal transduction pathways and, 297, 298f  
   tumor cell proliferation/survival from, 304  
 survival/death mechanisms of, 352  
 therapeutic approaches to, 295–297, 310  
 tyrosine kinases target, 300
- Cancer genetics, **284**, 294  
 cDNA array experiment and, 293f  
 classes of, 285  
   caretakers, 285  
   two-hit hypothesis of, 285  
 future of, 293  
 historical perspective of, 284
- Cancer Genome Anatomy Project (CGAP), 293
- Cancer of the Liver Italian Program (CLIP), 491  
 staging system for HCC, 491, 492t
- Cancer prevention, **332**  
 education/healthful habits and, 332–334  
   diet modification, 333–334  
   energy balance, 334  
   physical activity, 333  
   smoking cessation, 332–333  
   sun avoidance, 334  
 surgery for, 337, 344
- Cancer screening, **337**  
 accuracy of, 337–338  
 for asymptomatic normal-risk subjects, 339t  
 diagnostic test value, 338t  
 negative/positive predictive value of, 337  
 potential biases for  
   healthy volunteer effect, 338  
   lead-time bias, 338  
   length-biased sampling, 338  
   selection bias, 338  
 potential drawbacks of, 338  
 for specific cancers, 339–341  
   breast cancer, 340  
   cervix cancer, 340  
   colorectal cancer, 340  
   endometrial cancer, 341  
   lung cancer, 341  
   ovarian cancer, 341  
   prostate cancer, 341  
   skin cancer, 341  
 specificity/sensitivity of, 337, 697, 721  
 test assessment of, 339
- Cancer stem cells, 441  
 damaging/removing of, 344  
 hematopoietic stem cells v., 309  
 initiation/progression of, 309f  
 unlimited proliferative capacity of, 308
- Cancer treatment, **343**  
 biologic therapy and, 370–373  
   immune mediators/antitumor effects of, 371–373  
 biopsy for, 345  
 chemotherapy and, 349–370  
   acute complications of, 366–370  
   chemotherapeutic agents for, 353–364  
   drug action end points and, 349–351  
   drug overview/use, 351–352  
   targeted therapies, 364–366  
 gene therapy for, 373  
 goal of, 343  
 host immunity suppressed by, 371  
 normal organs and, 343–344  
 radiation therapy and, 346–349  
   delivery of, 348–349  
   physical properties/biologic effects of, 346–348, 347f  
   toxicity of, 349

- Cancer treatment (*Cont.*):  
 surgery as, 344–346  
 diagnosis, 344–345  
 prophylaxis, 344  
 targeted agents v. chemotherapy agents, 352  
 toxicity of, 343  
 types of, 343
- Capecitabine, 315, 356t, 502
- Capnocytophaga canimorsus*, 375
- Carbamazepine, 204, 406, 548, 638
- Carbon monoxide poisoning, 93
- Carboplatin, 354t, 437, 456, 536
- $\gamma$ -Carboxylation process, 243, 276
- Carcinoid crisis, 587, 588  
 treatment for, 704, 730
- Carcinoid syndrome, **586**  
 atypical/typical type of, 586  
 carcinoid tumors with, 584–585  
 carcinoid tumors without, 585  
 clinical features of, 586, 586t  
 diarrhea, 586  
 flushes, 586  
 wheezing/asthma-like symptoms, 586  
 diagnosis of, 587–588  
 urinary 5HIAA levels, 587  
 life-threatening complication for, 587  
 pathobiology for, 586–587  
 serotonin secretion and, 586  
 treatment for, 588–589  
 chemotherapy, 589
- Carcinoid tumors, 487, **584**. *See also*  
 Neuroendocrine tumors  
 with carcinoid syndrome  
 appendiceal, 584  
 characteristics of, 584  
 gastric, 585  
 rectal, 585  
 small intestine, 584–585  
 without carcinoid syndrome, 585  
 chemotherapy for, 596  
 diagnosis of, 587–588  
 urinary 5HIAA levels, 587  
 MEN1 and, 600  
 radiotherapy for, 596  
 with systemic symptoms, 585  
 treatment for, 589, 596  
 gastrectomy for, 589
- Carcinoma of unknown primary (CUP), **562**  
 biology of, 562–565  
 clinical evaluation for, 562–563  
 imaging studies role of, 563  
 serum tumor markers/cytogenetics and, 563  
 as biopsy proven malignancy, 562  
 chest x-rays for, 563  
 cytokeratin markers in, 564f  
 “global” regimens for, 567  
 histology in, 564t  
 mammography for, 563
- Carcinoma of unknown primary (CUP) (*Cont.*):  
 pathologic diagnosis of, 563–565  
 immunohistochemical analysis and, 563–564, 564t  
 light microscopy evaluation, 563  
 PET for, 563  
 platinum-based chemotherapy for, 567  
 RT-PCR in, 565  
 standard workup for, 562  
 summary of, 567  
 treatment for  
 algorithm, 565f, 566f  
 favorable subsets of, 566–567  
 general considerations of, 565–566
- Carcinomatous meningitis, 558
- Cardiac biomarkers, elevated, 256
- Cardiopulmonary resuscitation (CPR), 414
- Cardiotoxicity, from chemotherapy, 360
- Cardiovascular system  
 dysfunction of, 689, 710  
 chronic constrictive pericarditis and, 659  
 myocardial fibrosis and, 659  
 pericardial effusion and, 659  
 infections in, 382
- CARET. *See*  $\beta$ -Carotene and Retinol Efficacy Trial
- Carmustine, 354t, 390
- Carney’s complex, 605
- $\beta$ -Carotene and Retinol Efficacy Trial (CARET), 335
- Casposfungin, for AML, 173
- Castleman’s disease, 204
- Castrate metastatic disease  
 pain management for, 521  
 prostate cancer and, 521  
 skeletal events during, 521
- Cataracts, from radiation exposure, 660
- Catheter-related infections, 378  
 approach to, 379t
- Cauda equina syndrome, 647
- CBC. *See* Complete blood count
- CCAAT/enhancer-binding protein  $\alpha$  (C/EBP $\alpha$ ), 166
- CCC. *See* Cholangiocarcinoma
- CCI. *See* Corrected count increment
- CCNU. *See* Lomustine
- CD. *See* Cluster designation
- CDGIIc. *See* Congenital disorder of glycosylation IIc
- CDKs. *See* Cyclin-dependent kinases
- C/EBP $\alpha$ . *See* CCAAT/enhancer-binding protein  $\alpha$
- CEL. *See* Chronic eosinophilic leukemia
- Cell cycle progression  
 inhibition of, 300  
 tumors and, 344
- Cell division  
 asymmetric, 3  
 symmetric, 3
- Cell-surface phenotyping, for lymphoid malignancies, 186
- Cellulitis  
 cause of, 377  
 treatment for, 377
- Census Bureau, U.S., 320
- Central nervous system (CNS)  
 brain/vertebral metastases and, 547  
 chemotherapy toxicity and, 561  
 infections of, 380  
 brain masses as, 380  
 differential diagnosis for, 381t  
 encephalitis as, 380  
 meningitis as, 380  
 lymphoma of, 553–554  
 primary, 553–554, 553f  
 secondary, 554  
 malignant primary tumors of, 547  
 metastases to, 689, 709  
 radiation necrosis of, 561  
 radiation therapy toxicity and, 560–561
- Cephalosporin, 48  
 for AML, 173
- Cerebellar degeneration  
 anti-Yo antibodies and, 636  
 treatment for, 636
- Cerebellar gait/limb ataxia, 634
- Cerebrospinal fluid (CSF)  
 hydrocephalus from obstruction of, 559  
 malignant cells in, 548  
 reference range of, 676–677t
- Ceruloplasmin, 72
- Cervical adenopathy  
 evaluation algorithm for, 435f  
 SCC presenting as, 566
- Cervical intraepithelial neoplasia (CIN), 536
- Cervix cancer, **536**  
 clinical presentation for, 537  
 etiology/genetics and, 536  
 HPV and, 536  
 incidence/epidemiology of, 536  
 Pap smears for, 340, 537  
 prevention for, 537  
 screening for, 340, 537  
 staging of, 537, 538f  
 survival rates for, 538f  
 treatment for, 537–538
- Cetuximab (Erbix), 299t, 485, 656
- CGAP. *See* Cancer Genome Anatomy Project
- CGD. *See* Chronic granulomatous disease
- CGH. *See* Comparative genomic hybridization
- Chédiak-Higashi syndrome (CHS), 50, 51t, 394  
 characteristic granules found in, 52f  
 peripheral blood smear of, 63f
- Cheilitis, 430
- Chemistry, laboratory units/measurements of, 666–672t
- Chemokines, major groups of, 47

- Chemoprevention, **334**, 696, 720  
 of breast cancer, 336  
 of colon cancer, 335–336  
 for head/neck cancer, 437  
 of prostate cancer, 336  
 of upper aerodigestive tract, 334–335  
 vaccines for, 337
- Chemoradiotherapy  
 combined-modality, for SCLC, 456  
 concomitant  
 for head/neck cancer, 435–436  
 success of, 436
- Chemoreceptor trigger zone (CTZ), 407
- Chemotherapy, **343**, **349**  
 acute complications of, 366–370, 690, 710  
 diarrhea, 370  
 gonadal dysfunction/pregnancy, 370  
 mucositis, 370  
 myelosuppression, 366–369  
 nausea/vomiting, 369  
 for advanced GCTs, 527  
 alkylating agents for, 359  
 for AML, 171–172  
 for anaplastic thyroid cancer, 577  
 anemia from, 368  
 for bladder cancer, 507–508  
 for brain metastasis, 558  
 cancer caused by, 660–661  
 cancers curable with, 350t  
 for carcinoid syndrome, 589  
 for carcinoid tumors, 596  
 cardiotoxicity from, 360  
 chemotherapeutic agents for, 353–364  
 direct DNA-interactive agents, 353, 359–361  
 hormonal agents, 363–364  
 indirect DNA-function effectors, 361–362  
 mitotic spindle inhibitors, 362–363  
 chondrosarcoma resistance to, 544  
 clinical syndromes produced by, 661  
 for CML, 180  
 conventional dose regimens of, 349  
 delivery of, 349  
 drug action end points and, 349–351  
 drug overview/use for, 351–352  
 conventional, 351  
 hormonal therapy, 351  
 MTD for, 351  
 targeted agents, 351  
 therapeutic index, 351  
 toxicity grading scale for, 351–352  
 for esophageal cancer, 474  
 fertility influenced by, 660  
 for gestational trophoblastic neoplasia, 539  
 for HCC, 495  
 for head/neck cancer, 435  
 HUS related to, 654  
 for islet cell tumors, 601  
 for MTC, 604
- Chemotherapy (*Cont.*):  
 for multiple myeloma, 213  
 for NSCLC, 455  
 for ovarian cancer, 533–534  
 initial/maintenance, 533  
 palliative/end-of-life care and, 350–351  
 partial/complete response of, 350  
 platinum-based, 536, 537, 566  
 for primary CNS lymphoma, 553  
 resistance to, 352  
 risk-directed, 527–528  
 salvage, 528–529  
 second-line, 567  
 side effects of, 589  
 spermatogenesis after, 529  
 targeted agents v., 352  
 targeted therapies for, 364–366, 365f  
 hematopoietic neoplasms, 364–366  
 solid tumors, 366  
 thrombocytopenia from, 367  
 toxicity of, 561  
 for uterine cancer, 536  
 vaccinations indicated in, 376t
- Chest roentgenography, 257
- Chest x-ray  
 for CUP, 563  
 for lymphadenopathy, 34
- Cheyne-Stokes breathing, 416
- CHE. *See* Congestive heart failure
- Childhood Cancer Survivor Study, 662
- Chlamydomyxa psittaci*, 185
- Chlorambucil, 196, 354t, 359  
 for CLL, 194  
 for MALT lymphoma, 195  
 side effects of, 359
- Chloramphenicol, 47, 130, 167
- Chlornaphazine, 504
- 2-Chlorodeoxyadenosine, 48, 356t, 362
- Chloroma, 169
- Chloroquine, 167
- Chlorpromazine, 408, 411
- Cholangiocarcinoma (CCC), 497, 687, 707  
 predisposing factors for, 497  
 treatment for, 497
- Cholecystectomy, 115
- Cholesterol, classification levels of, 676t
- Cholestyramine, 105
- Chondrosarcoma  
 bone sarcoma and, 544–545  
 chemotherapy resistance of, 544  
 diagnosis of, 544  
 histiologic variants of, 545
- CHOP. *See* Cyclophosphamide, doxorubicin, vincristine, prednisone
- Chromosomal instability (CIN), in tumor cells, 292
- Chromosomal translocations  
 in CML, 291, 291t  
 of oligodendrogliomas, 552  
 oncogenes and, 290–291, 291t
- Chronic constrictive pericarditis, 659
- Chronic disseminated candidiasis, 379
- Chronic eosinophilic leukemia (CEL), 154
- Chronic granulomatous disease (CGD), 50, 51t
- Chronic idiopathic myelofibrosis. *See* Idiopathic myelofibrosis
- Chronic inflammation, hypoproliferative anemia and, 77–78
- Chronic lymphoid leukemia (CLL), 182  
 etiology of, 184  
 evaluation of, 189, 695, 719  
 genetic abnormalities of, 187  
 lymphoid disorders confused with, 183t  
 peripheral blood smear of, 66f, 194f  
 staging system for, 189, 189t
- Chronic myelogenous leukemia (CML), 154, **175**  
 allogeneic stem cell transplant for, 177, 395  
 chromosomal translocation in, 291, 291f  
 clinical presentation of, 176–177, 692, 713, 715  
 chromosomal findings, 177  
 hematologic findings, 176–177  
 physical findings, 176  
 symptoms, 176  
 definition of, 175  
 etiology of, 175–176  
 Hasford system/Sokal index for, 177  
 incidence of, 175  
 minimal residual disease and, 180–181  
 pathophysiology of, 176  
 disease progression, 176  
 Ph in, 291  
 prognostic factors for, 177  
 treatment for, 177–181  
 allogeneic SCT, 177–179  
 autologous SCT, 180  
 blast crisis, 181  
 chemotherapy, 180  
 IFN- $\alpha$ , 180  
 leukapheresis/splenectomy, 180
- Chronic myeloid leukemia, 297  
 hematopoietic stem cell transplantation for, 395–396  
 peripheral blood smear of, 66f
- Chronic myelomonocytic leukemia (CMML), 139
- Chronic myeloproliferative disorders, WHO classification of, 154–155, 154t
- Chronic neutrophilic leukemia (CNL), 154
- Chronic nonspherocytic hemolytic anemia (CNSHA), 118  
 G6PD with, 119
- Chronic obstructive pulmonary disease (COPD), 399, 692, 714
- CHS. *See* Chédiak-Higashi syndrome
- Cidofovir, 656  
 for herpes viruses, 385t

- Cigarette smoking, 334  
 as addiction, 333  
 bladder cancer and, 504  
 cancer risk from, 332  
 cessation of, 332–333, 441  
 lung cancer and, 440
- CIN. *See* Cervical intraepithelial neoplasia;  
 Chromosomal instability
- Circulatory function tests, reference range of,  
 680t
- Cisplatin, 121, 329, 354t, 369, 435, 437, 456,  
 495, 507, 528, 533, 536, 537, 544  
 delivery of, 359  
 toxicity of, 360, 561
- Cisplatin, bleomycin, etoposide (BEP), 527
- Cisplatin, ifosfamide, and vinblastine (VeIP),  
 for testicular cancer, 528
- Cisplatin, methotrexate, and vinblastine  
 (CMV), 507
- Citalopram, 410
- Cladribine, for WM, 215
- Clear cell tumors, 508
- CLIP. *See* Cancer of the Liver Italian Program
- CLL. *See* Chronic lymphoid leukemia
- Clonidine, 593
- Clopidogrel, 691, 712–713  
 action mechanism of, 693, 715  
 for angina, 267
- Clostridium difficile*-induced diarrhea, 380
- Clotrimazole, 88
- Clotting factor assembly, 23
- Cluster designation (CD), 167
- CML. *See* Chronic myelogenous leukemia
- CMML. *See* Chronic myelomonocytic leukemia
- CMV. *See* Cisplatin, methotrexate, and  
 vinblastine; Cytomegalovirus
- CNL. *See* Chronic neutrophilic leukemia
- CNS. *See* Central nervous system
- CNSHA. *See* Chronic nonspherocytic  
 hemolytic anemia
- Coagulation  
 acquired inhibitors for, 244  
 cascade/clotting factor deficiency  
 laboratory assessment of, 236f  
 factor activity for, 29f  
 inhibitors for, 235  
 laboratory units/measurements of,  
 664–666t  
 TF initiation of, 23f  
 thrombogenesis and, 265f  
 vitamin K as cofactor for, 685, 705
- Coagulation disorders, **235**, 701, 726  
 diagnosis of, 701, 726  
 genetic/laboratory characteristics of, 236t  
 in liver disease, 243, 244t
- Cobalamin (Vitamin B<sub>12</sub>), **95**  
 absorption of, 96, 107  
 cobalamin–folate relation with, 99  
 dietary sources/requirements for, 95–96  
 transportation of, 96
- Cobalamin deficiency  
 in adults/infants, 101–102  
 causes of, **101**, 102t  
 congenital intrinsic factor deficiency/  
 functional abnormality and, 103  
 diagnosis of, **106**  
 cobalamin absorption, 107  
 red cell folate, 107  
 serum cobalamin, 106  
 serum folate, 107  
 serum methylmalonate/homocysteine,  
 106–107  
 food cobalamin malabsorption and, 103  
 gastrectomy and, 103  
 gastric causes of  
 gastric biopsy, 102  
 PA, 102  
 serum antibodies, 102–103  
 general tissue effects of, 99–100  
 inadequate dietary intake and, 101–102  
 intestinal causes of  
 drugs, 104  
 fish tapeworm infestation, 103–104  
 gluten-induced enteropathy, 104  
 GVHD, 104  
 HIV infection, 104  
 ileal resection, 103  
 intestinal stagnant loop syndrome, 103  
 radiotherapy, 104  
 selective malabsorption of cobalamin  
 with proteinuria, 103  
 severe chronic pancreatitis, 104  
 tropical sprue, 103  
 Zollinger–Ellison syndrome, 104  
 juvenile pernicious anemia and, 103  
 malabsorption of, 102t  
 metabolism abnormalities and  
 acquired abnormality of cobalamin  
 metabolism, 104  
 congenital methylmalonic  
 acidemia/aciduria, 104  
 congenital transcobalamin II  
 deficiency/abnormality, 104  
 nitrous oxide inhalation, 104  
 treatment of, 107–108
- Codeine, for pain intervention, 405
- Cold agglutinin disease (CAD), 123–124
- Colloid cysts, 555
- Colonoscopy, 340, 687, 697, 707–708, 721  
 as colorectal cancer screening tool, 481  
 polyps and, 478
- Colony-stimulating factors  
 (CSFs), 42
- Color serum, in hemoglobinemia, 68f
- Colorectal cancer, **477**  
 air-barium enema for, 482f  
 animal fats and, 478–479  
 annular/constricting adenocarcinoma as,  
 482f  
 chemoprevention of, 335–336
- Colorectal cancer (*Cont.*):  
 clinical features for, 482–484  
 presenting symptoms, 482  
 staging/prognostic factors/spreading  
 patterns, 482–484, 483f  
 etiology/risk factors for, 478–479, 478t  
 diet and, 478–479  
 hereditary factors/syndromes and, 479–480  
 high risk conditions for, 480–481  
 streptococcus bovis bacteremia, 480  
 tobacco use, 480–481  
 IBD and, 480  
 incidence of, 477  
 insulin resistance/fiber and, 479  
 late effects/consequences of, 662  
 polyps/molecular pathogenesis of, 478  
 primary prevention for, 481  
 reoccurrences of, 483  
 screening for, 340, 481–482, 697, 721  
 colonoscopy, 481  
 large-bowel cancer detection and,  
 481–482  
 stage 1 of, 483  
 stage II of, 483  
 stage III of, 483  
 stage IV of, 483  
 total surgical resection of, 484  
 poor outcome predictors  
 for, 483f  
 treatment for, 484–485  
 monoclonal antibodies, 485  
 radiation therapy, 484  
 systemic therapy, 484–485  
 total surgical resection, 483f, 484
- COMMIT. *See* Community Intervention  
 Trial for Smoking Cessation
- Communication  
 advance care planning and, 402  
 palliative/end-of-life care and, 400  
 P-SPIKES procedure for, 400, 401t
- Community Intervention Trial for Smoking  
 Cessation (COMMIT), 333
- Comparative genomic hybridization (CGH),  
 290
- Compazine. *See* Prochlorperazine
- Complete blood count (CBC), 12
- Complete remission (CR), 170
- Complications, from cancer. *See* Late  
 effects/complications from cancer
- Compression ultrasonography  
 for DVT, 250  
 for thrombophlebitis, 630
- Computed tomography (CT)  
 of chest, 257, 257f  
 lung cancer screening and, 444–445  
 for pheochromocytoma diagnosis, 611
- Computerized Symptom Assessment  
 Instrument, 399
- Condensed Memorial Symptom Assessment  
 Scale, 400

- Congenital disorder of glycosylation IIc (CDGIIc), 49
- Congenital methylmalonic acidemia/aciduria, 104
- Congenital transcobalamin II deficiency, 104
- Congestive heart failure (CHF)  
anthracycline-induced, 659  
from doxorubicin, 659
- Conivaptan, 626
- Constipation  
medication management for, 407t  
in palliative/end-of-life care, 406–407  
assessment for, 406  
etiology of, 406  
frequency of, 406  
intervention for, 406–407
- Coombs-negative AIHA, 123
- COPD. *See* Chronic obstructive pulmonary disease
- Cord blood stem cells  
features of, 6  
T cells in, 6
- Core-needle biopsy, 345
- Corrected count increment (CCI), 147
- Cortical encephalitis, 634
- Corticotropin-releasing hormone (CRH), 599  
Cushing's syndrome from, 626
- Cowden's disease, 605
- COX-1. *See* Cyclooxygenase-1
- COX-2. *See* Cyclooxygenase-2
- CPR. *See* Cardiopulmonary resuscitation
- CPT-II. *See* Irinotecan
- CR. *See* Complete remission
- Craniopharyngiomas, 555
- Cremophor-containing vehicle, 363
- CRH. *See* Corticotropin-releasing hormone
- Crow-Fukase syndrome, 608  
presentation of, 608  
systemic nature of, 608
- Cryptorchidism, 524
- CSF. *See* Cerebrospinal fluid
- CSFs. *See* Colony-stimulating factors
- CT. *See* Computed tomography; Spiral computed tomography
- CTL. *See* Cytotoxic T lymphocytes
- CTZ. *See* Chemoreceptor trigger zone
- CUP. *See* Carcinoma of unknown primary
- Curative therapy, for melanoma, 428
- Cushing's syndrome, 585, 594  
adrenocortical tumors and, 615, 617  
cause of, 600  
from CRH production, 626  
from ectopic ACTH production, 626–627  
clinical manifestations of, 626  
diagnosis of, 626–627  
etiology of, 626  
treatment for, 627
- Cutaneous anaplastic large T/null cell lymphoma, 201
- Cutaneous T cell lymphoma, 200
- CVP. *See* Cyclophosphamide, vincristine, prednisone
- CXCL12, CXCR4 interaction with, 3
- CXCR4, CXCL12 interaction with, 3
- Cyanocobalamin, 107
- Cyclin-dependent kinases (CDKs), 295
- Cyclooxygenase-1 (COX-1), 265
- Cyclooxygenase-2 (COX-2), 266, 336, 480
- Cyclophosphamide, 124, 135, 138, 354t, 390, 391, 394, 504, 539, 545, 636  
activation of, 359  
for allogeneic SCT preparation, 178  
for TTP, 230
- Cyclophosphamide, doxorubicin, vincristine, prednisone (CHOP), 191, 198
- Cyclophosphamide, vincristine, doxorubicin, dexamethasone, cytarabine, and methotrexate (HyperC-VAD), 196
- Cyclophosphamide, vincristine, prednisone (CVP), 194
- Cyclosporine, 48, 106, 135, 138
- Cyclosporine A, 126
- CYP. *See* Cytochrome P450
- Cystectomy, for bladder cancer, 506
- Cystoscopy, for benign prostate disease, 522
- Cytarabine, 174, 559, 649  
for AML, 171–172  
for CML, 179  
hematologic toxicity of, 172  
toxicity of, 561
- Cytochrome P450 (CYP), 267
- Cytogenetics  
CUP and, 563  
in ET, 162  
in lymphoid malignancies, 188t
- Cytokeratin markers, 698, 722  
in CUP, 564f  
subtypes of, 564
- Cytokines  
biologic therapy and, 372–373  
skin side effects of, 378
- Cytomegalovirus (CMV), 146, 151, 393
- Cytoreductive surgery  
for NETs, 596  
for ovarian cancer, 533
- Cytosine arabinoside (ara-C), 356t, 362, 654
- Cytotoxic T lymphocytes (CTL), 297
- Dacarbazine, 329, 354t
- Daclizumab, 138
- Dactinomycin, 539
- Danaparoid, for HIT, 228
- Danazol, 160
- Dapsone, 121, 705
- Darunavir, 717
- Dasatinib (Sprycel), 180, 358t, 359, 364
- DAT. *See* Direct antiglobulin test
- Daunorubicin, 171, 355t
- DCIS. *See* Ductal carcinoma in situ
- DCP. *See* Des- $\gamma$ -carboxy prothrombin
- DDAVP. *See* 1-deamino-8-D-arginine vasopressin
- D-dimer enzyme-linked immunosorbent assay, 256, 694, 717
- 1-deamino-8-D-arginine vasopressin (DDAVP), 231, 238, 705  
for hemophilia A, 238
- Death  
from cancer, 321, 321f, 321t, 330–331  
women v. men, 322f  
from heart disease, 321f  
from infection, 374  
leading causes of, 398t  
trends in site/location of, 399t
- Decitabine, 141. *See also* 5-Deoxyazacytidine
- Deep vein thrombosis (DVT), 25, 694, 717  
clinical likelihood of, 254, 255t  
compression ultrasonography for, 250  
diagnosis of, 249–250  
diagnostic imaging needed for, 255f  
differential diagnosis of, 255t  
imaging tests for, 258f  
integrated diagnostic approach to, 258  
invasive diagnostic modalities for, 258  
nonimaging diagnostic modalities for, 256  
noninvasive imaging modalities for, 256–258  
PE v., 253  
post-thrombotic syndrome and, 252  
risk factor for, 28  
signs/symptoms of, 249  
treatment for, 251–252, 258–259  
primary therapy v. secondary prevention, 258  
risk stratification, 258–259  
with VKA, 251t  
venous ultrasonography of, 257f
- Defensins, azurophil granules and, 43
- Deferasirox, 93, 136
- Deferoxamine (Desferal), 93, 136
- Defibrotide, 391
- Delayed hemolytic transfusion reaction (DHTR), 148
- Delirium  
medications for management of, 411t  
in palliative/end-of-life care  
assessment for, 411  
etiology of, 410–411  
frequency of, 410  
interventions for, 411–412
- Delirium Rating Scale, 411
- Demeclocycline, 625
- Denileukin difitox, 358t
- 5-Deoxyazacytidine, 88
- Deoxycoformycin, 356t
- Deoxycytidine analogue gemcitabine, 502
- Deoxyuridine triphosphate (dUTP), 98

- Depression  
 in palliative/end-of-life care  
 assessment for, 409–410  
 etiology of, 409  
 frequency of, 409  
 interventions for, 410  
 recognition/treatment of, 327
- Dermoid cysts, 555
- Desferal. *See* Deferoxamine
- Des- $\gamma$ -carboxy prothrombin (DCP), 492
- Desipramine, 327
- Desmoplastic melanoma, 423
- Desmoteplase, 282
- Dexamethasone, 210, 329, 406, 409, 548, 626, 649, 687, 707  
 for increased ICP, 648  
 for lung cancer, 454
- Dexrazoxane, 659
- Dextroamphetamine, 409, 410
- DHR. *See* Dihydrorhodamine
- DHTR. *See* Delayed hemolytic transfusion reaction
- Diabetes mellitus, 18  
 islet cell tumors and, 601  
 megaloblastic anemia and, 108  
 pancreatic cancer and, 499  
 PGA syndrome and, 607  
 POEMS syndrome and, 215
- Dialysis  
 for HHM, 625  
 long-term, 106
- Diamond-Blackfan anemia, 137, 395
- Diapedesis, 46
- Diarrhea  
 carcinoid syndrome and, 586  
 as chemotherapy complication, 370  
*Clostridium difficile*-induced, 380
- Diazoxide, for insulinomas, 591
- DIC. *See* Disseminated intravascular coagulation
- Diet  
 bleeding/thrombosis influenced by supplements, 27  
 breast cancer and, 460  
 cancer prevention and, 333–334  
 cobalamin from, 95–96  
 colorectal cancer and, 478–479  
 animal fats and, 478–479  
 fiber and, 479  
 insulin resistance and, 479  
 head/neck cancer factors from, 438  
 iron from, 72  
 polyps from, 333
- Diethylstilbestrol, 519
- Diferric transferrin, 70
- Differentiation  
 HA and, 111  
 of hematopoietic stem cells, 2, 3f, 4–5  
 hierarchy of, 5f
- Differentiation, of hematopoietic stem cells (Cont.):  
 maturation steps for, 4  
 regulation of, 5f  
 for SCLC, 623
- Diffuse large B cell lymphoma, 197–198  
 Burkitt's lymphoma v., 199  
 diagnosis of, 197  
 evaluation of, 197–198  
 in lymph node, 67f  
 peripheral blood smear of, 67f, 197f  
 presentation of, 197  
 treatment for, 198
- DiGeorge syndrome, 607
- Digital rectal examination (DRE), 340  
 abnormal, 513
- Dihydrorhodamine (DHR), 56
- Dilute Russell viper venom test (dRVVT), 30
- Dimethyl sulfoxide, 391
- Diphenhydramine, 653
- Diphenoxylate, 588
- Dipyridamole, 267–268  
 action mechanism of, 267, 268f  
 indications for, 268  
 side effects of, 268
- Direct antiglobulin test (DAT), 148
- Direct Coombs test, 148
- Direct thrombin inhibitors (DTIs), 228
- Disease, hematopoietic stem cells influenced by, 4
- Disease acceleration, 177
- Disseminated CUP, management of, 566–567
- Disseminated intravascular coagulation (DIC), 226, 235, **240**  
 causes of, 240, 241t  
 chronic, 242  
 chronic liver disease v., 701–702, 727  
 clinical manifestations of, 241–242  
 diagnosis of, 242  
 differential diagnosis of, 242  
 mechanism of, 241  
 pathophysiology of, 241f  
 protein C for, 243  
 purpura fulminans and, 240  
 treatment for, 242–243  
 antifibrinolytic drugs and, 242–243  
 hemorrhagic symptom management, 242  
 inhibitor replacement, 242–243
- Divalent metal transporter 1 (DMT-1), 72
- DLT. *See* Dose-limiting toxicity
- DMT-1. *See* Divalent metal transporter 1
- DNA amplification, oncogenes and, 290
- DNA damage checkpoint, 296f
- DNA function  
 direct interactive agents for, 353, 359–361  
 indirect effectors of, 361–362
- DNR. *See* Do-not-resuscitate
- Docetaxel, 357t, 363, 437, 455, 467, 521
- Döhle bodies, 44  
 neutrophil band with, 44f  
 peripheral blood smear of, 63f
- Dolasetron (Anzemet), 369
- Donath-Landsteiner antibodies, 123, 145
- Do-not-resuscitate (DNR), 415
- Dorsal root ganglia, PND and, 632–633
- Dorsal root ganglionopathy, characteristics for, 637
- Dose-limiting toxicity (DLT), 351
- Doxepin, 157
- Doxorubicin, 355t, 521, 534, 536, 543, 544, 545  
 CHF from, 659  
 for HCC, 495
- Doxorubicin, bleomycin, vinblastine, and dacarbazine (ABVD), 203
- DRE. *See* Digital rectal examination
- Drug-induced thrombocytopenia, 226–227, 227t
- Drugs. *See also* Antiplatelet drugs; Antithrombotic drugs; Fibrinolytic drugs; Nonsteroidal anti-inflammatory drugs  
 therapeutic monitoring of, 672–675t
- dRVVT. *See* Dilute Russell viper venom test
- DTIs. *See* Direct thrombin inhibitors
- Ductal carcinoma in situ (DCIS), 469  
 prognostic features of, 469
- Durable attorney, advance care planning and, 402
- Durie-Salmon staging system, for multiple myeloma, 212t
- dUTP. *See* Deoxyuridine triphosphate
- DVT. *See* Deep vein thrombosis
- Dysfibrinogenemia, 31, 491, 509, 696, 720  
 vitamin K deficiency and, 243
- Dysgerminoma, 534
- Dyskeratosis congenita, 131
- Dysphagia, 694, 717  
 as esophageal cancer clinical feature, 473
- Dysplastic nevi, 425
- Dyspnea  
 medication management for, 408t  
 in palliative/end-of-life care  
 assessment for, 407–408  
 frequency of, 407  
 intervention for, 408  
 PE and, 256
- Dysproteinemia, 205
- Early Lung Cancer Action Project (ELCAP), 444
- Eastern Cooperative Oncology Group (ECOG), 350
- Eaton-Lambert syndrome, 444
- EBV. *See* Epstein-Barr virus
- EC. *See* Endothelial cells

- Echocardiography, 258  
 normal value reference range of, 681t
- ECM. *See* Extracellular matrix
- ECOG. *See* Eastern Cooperative Oncology Group
- Ectopic hormone production, 622  
 clinical manifestations of, 623  
 paraneoplastic syndromes caused by, 624f
- Ectopic vasopressin: tumor-associated SIADH  
 clinical manifestations of, 625  
 diagnosis of, 625  
 etiology of, 625  
 treatment of, 625–626
- Eculizumab, 126
- ED&C. *See* Electrodesiccation and curettage
- Edmonton Symptom Assessment System, 400
- EDTA. *See* Ethylenediamine tetraacetic
- Effusions, cancer supportive care for, 329
- EGFR. *See* Epidermal growth factor receptor
- EHE. *See* Epithelioid hemangioendothelioma
- ELCAP. *See* Early Lung Cancer Action Project
- Electrocardiogram, 256
- Electrodesiccation and curettage (ED&C), 430
- Electrolyte toxicity, transfusion therapy and, 150
- Electroretinogram (ERG), 639
- ELISA. *See* Enzyme-linked immunosorbent assay
- Elliptycycytosis, peripheral blood smear of, 61f
- ELSTs. *See* Endolymphatic sac tumors
- Embsden-Meyerhof pathway, 19, 112f
- Embryonal rhabdomyosarcoma, 545
- Encephalitis  
 brainstem, 634  
 limbic, 632–633, 634, 634f  
 predisposition for, 380  
 treatment for, 635–636
- Encephalomyelitis, 634  
 treatment for, 635–636
- Endocarditis, 122, 480  
 bacterial, 105, 382  
 Loeffler's, 55  
*streptococcus bovis*, 686, 706
- Endocrine dysfunction, 659
- Endocrine paraneoplastic syndromes, **622**  
 ectopic hormone production and, 623  
 etiology of, 622–623  
 cellular differentiation and, 623  
 genetic rearrangements and, 623  
 prevalence of, 622
- Endocrine syndromes, 444  
 infections of, 382
- Endocrine therapy, for breast cancer, 468, 468t
- Endocrine/nutritional deficiencies  
 hypometabolic state anemia and, 79  
 hypoproliferative anemia and, 77  
 “End-of-Treatment Consultation Note,” 657
- Endolymphatic sac tumors (ELSTs), 613
- Endometrial cancer, screening for, 341
- Endometrium, proliferation of, 535
- Endoscopic fulguration, as esophageal cancer treatment, 474
- Endoscopic resection, for bladder cancer, 505
- Endoscopic retrograde cholangiopancreatography (ERCP), 500  
 for pancreatic cancer, 501f
- Endoscopic ultrasound (EUS), 500, 594
- Endothelial cells (EC), 310, 311f  
 molecular determinants of, 312f
- Endotoxin, 47
- End-stage renal disease (ESRD), 217
- Enoxaparin, 259
- Enteropancreatic tumors, as MEN1 manifestation, 598
- Enteropathy-type intestinal T cell lymphoma, 202
- Enzyme-linked immunosorbent assay (ELISA), 106, 228, 256
- Eosinopenia, 55
- Eosinophil(s)  
 distinctive features of, 54  
 function enhancing of, 54  
 normal, peripheral blood smear of, 63f  
 normal morphology of, 45f
- Eosinophilia, 54–55, 628t  
 etiology of, 629  
 treatment for, 629
- Eosinophilia-myalgia syndrome, 55, 690, 711
- Eosinophilic fasciitis, 131
- Ependymomas, 552
- Epidermal growth factor receptor (EGFR), 485  
 lung cancer mutations of, 300  
 targeted therapy for, 455
- Epidermoid tumors, 555
- Epigenetic modification  
 cancer cell transcription alterations and, 302–305, 303f  
 in cancer gene expression, 292
- Epilepsy, treatment of, 548
- Epinephrine, 49
- Epirubicin, 355t, 476, 536
- Epistaxis, 26
- Epithelioid hemangioendothelioma (EHE), 497
- EPO. *See* Erythropoietin
- Epstein-Barr virus (EBV), 184  
 Burkitt's lymphoma associated with, 185
- Eptifibatide, 268–269, 269t  
 for MI, 269
- ER. *See* Estrogen receptors
- Erbix. *See* Cetuximab
- ERCC1. *See* Excision-repair-cross complementation group 1
- ERCP. *See* Endoscopic retrograde cholangiopancreatography
- Erectile function, recovery of, 517
- ERG. *See* Electroretinogram
- Erlotinib (Tarceva), 299t, 300, 358t, 455, 485, 654
- Erythema multiforme, 378
- Erythrocytosis, 628t  
 causes of, 156  
 complications of, 157  
 etiology of, 628  
 treatment of, 628
- Erythroid hyperplasia, bone marrow of, 17f, 64f
- Erythroleukemia, acute, peripheral blood smear of, 65f
- Erythromelalgia, 157
- Erythron, red cell production by, 10
- Erythrophagocytosis, 122, 122f  
 with aggressive lymphoma, 67f
- Erythropoiesis  
 critical elements of, 11  
 HA and, 111  
 ineffective, 18  
 iron-deficient, 73  
 suppression of, 78f
- Erythropoietin (EPO), 10, 112  
 anemia influenced by, 11, 11f  
 fundamental stimulus of, 11  
 half-clearance time of, 11  
 as hypoproliferative anemia treatment, 79–80  
 polycystic kidney disease and, 78  
 as red cell production regulator, 10–11
- Erythropoietin growth factor, 4
- Escherichia coli* bacteremia, papules related to, 377f
- Esophageal cancer, **472**, 693–694, 716  
 clinical features of, 473  
 dysphagia, 473  
 diagnosis of, 473  
 incidence/etiology of, 472–473  
 risk factors for, 473  
 as SCC/adenocarcinoma, 472  
 treatment for, 473–474  
 chemotherapy, 474  
 endoscopic fulguration, 474  
 radiation therapy, 474
- ESRD. *See* End-stage renal disease
- Essential thrombocytosis (ET), 154  
 causes of, 161t  
 clinical features of, 161  
 clonal nature of, 161  
 complications of, 162  
 diagnosis of, 162  
 etiology of, 161  
 nonrandom cytogenetic abnormalities in, 162  
 treatment of, 162–163

- Estramustine phosphate, 358t, 521  
binding of, 363
- Estrogen receptors (ER), inhibition of, 305
- ET. *See* Essential thrombocytosis
- Ethiodol (Lipiodol), 492
- Ethylene oxide, 167
- Ethylenediamine tetraacetic (EDTA), 225
- Etidronate, for HHM, 625
- Etoposide, 171, 355t, 361, 369, 390, 456, 539, 545, 656
- EUS. *See* Endoscopic ultrasound
- Euthanasia, 415–416  
definitions of, 415t  
legal aspects of, 416  
practices of, 416
- Ewing's sarcoma, 545  
aggressiveness of, 545  
“onion peel” characteristic of, 545
- Excisional biopsy, 345
- Excision-repair-cross complementation group 1 (ERCC1), 443
- Existential needs, in palliative/end-of-life care, 413–414  
assessment for, 413  
frequency of, 413  
interventions for, 413–414
- External beam radiation therapy, 517  
bowel complications from, 517  
radiation dose for, 517
- Extracellular matrix (ECM), 207
- Extramedullary plasmacytoma, 210
- Extranodal marginal zone B cell lymphoma of MALT type. *See* MALT lymphoma
- Extranodal T/NK cell lymphoma of nasal type, 201
- Extrathoracic metastatic disease, 443
- FAB. *See* French-American-British
- Factor IX deficiency (FIX) (Hemophilia B), 235, 701, 726  
alloantibodies and, 238  
dosage/replacement therapy for, 238  
unit dosage for, 237
- Factor replacement therapy, for hemophilia, 237
- Factor VIII deficiency (FVIII) (Hemophilia A), 235, 699, 723–724  
alloantibodies and, 238  
unit dosage for, 237
- Factor XI deficiency (FXI), 235, **239**  
clotting activity in, 239  
formation of, 239  
prevalence of, 239  
treatment for, 239
- Fallopian tube carcinoma, **535**
- Famciclovir, for herpes viruses, 385t
- Familial adenomatous polyposis (FAP), 286
- Familial cancer syndromes, 286–288  
adenomas and, 286  
associated genes with, 287t
- Familial cancer syndromes (*Cont.*):  
genetic testing for, 288–289, 289f  
HNPCC as, 287
- Familial hemolytic uremic syndrome (HUS), 121
- Familial medullary thyroid carcinoma (FMTC), 601  
genetic mutations associated with, 603  
MEN2A and, 602
- Familial multiple coagulation deficiencies, 240  
Vitamin K-dependent coagulation factors and, 240
- Family caregivers, in palliative/end-of-life care, 413
- Family Medical Leave Act (FMLA), 412
- Fanconi's anemia, 131, 208
- FAP. *See* Familial adenomatous polyposis
- Farnesyltransferase inhibitors (FTIs), clinical trials of, 301
- Fatigue, for palliative/end-of-life care  
assessment for, 409  
etiology of, 408  
frequency of, 408  
intervention for, 409
- FDA. *See* Food and Drug Administration
- FDG-PET. *See* Positron emission tomography  
with <sup>18</sup>F-fluoro-2deoxyglucose
- Febrile neutrophilic dermatosis (Sweet's syndrome), 377–378  
diagnosis/treatment algorithm for, 383t  
presentation of, 377  
treatment of, 378
- Febrile nonhemolytic transfusion reaction (FNHTR), 148
- Fecal occult blood testing (FOBT), 340
- Felty's syndrome, 48–49
- Fertility  
chemotherapy influence on, 660  
ovarian germ cell tumors and, 534  
sexual/reproductive dysfunction and, 660  
testicular cancer and, 529
- α-Fetoprotein (AFP), 492, 525  
levels before/after orchiectomy, 526
- FFP. *See* Fresh-frozen plasma
- FGFR3. *See* Fibroblast growth factor receptor 3
- Fiber, colorectal cancer and, 479
- Fibrin clot formation, 23  
arterial thrombosis and, 264  
dissolution and, 24f  
intrinsic/extrinsic pathway for, 23
- Fibrinolysis, PE and, 261
- Fibrinolytic drugs, 264, **279**  
action mechanism of, 279–280  
new agents of, 282  
role of, 279  
therapeutic monitoring of, 672–675t
- Fibrinolytic system, 25  
physiologic regulation of, 25  
regulation of, 279f  
schematic diagram of, 25f
- Fibroblast growth factor receptor 3 (FGFR3), 505
- Fibrolamellar HCC (FL-HCC), 496
- FIGO. *See* International Federation of Gynecologists and Obstetricians
- Financial burdens, from palliative/end-of-life care, 412  
frequency of, 412  
intervention for, 412–413
- Finasteride, 336, 522
- Fine needle aspiration (FNA), 345, 570  
for adrenocortical tumors, 618  
for lymphadenopathy, 35
- FISH. *See* Fluorescence in situ hybridization
- Fish tapeworm infestation, 103–104
- FIX. *See* Factor IX deficiency
- Flavopiridol, 296
- FL-HCC. *See* Fibrolamellar HCC
- FLIPI. *See* Follicular lymphoma-specific IPI
- “Flower” cells, 200, 200f
- Fluconazole, 384, 387, 393
- Flucytosine, 47
- Fludarabine, 197, 357t, 362, 393  
for CLL, 194  
for WM, 215
- Fluorescence in situ hybridization (FISH), 162, 171, 290
- Fluoropyrimidine, 502
- 5-Fluorouracil (5-FU), 356t, 430, 435, 437, 468, 476, 484–485, 502, 503, 537  
adverse effects of, 362  
delivery of, 362  
metabolism of, 362
- Fluoxetine, 327, 410
- Fluoxymesterone (Halotestin), 363
- Flutamide, 364  
withdrawal response of, 521
- FMLA. *See* Family Medical Leave Act
- FMTC. *See* Familial medullary thyroid carcinoma
- FNA. *See* Fine needle aspiration
- FNH. *See* Focal nodular hyperplasia
- FNHTR. *See* Febrile nonhemolytic transfusion reaction
- FOBT. *See* Fecal occult blood testing
- Focal nodular hyperplasia (FNH), 498
- Folate, **96**  
absorption of, 96–97  
biochemical functions of, 97  
biochemical reactions of, 97t  
cobalamin-folate relation with, 99  
dietary, 96  
in DNA synthesis, 98f  
transportation of, 97



- Folate deficiency  
 anemia resulting from, 70  
 antifolate drugs and, 106  
 causes of  
   from malabsorption, 105–106  
   from nutrition, 104–105  
 congenital abnormalities of, 106  
 diagnosis of, 106  
   cobalamin absorption, 106–107  
   red cell folate, 107  
   serum cobalamin, 106  
   serum folate, 107  
   serum methylmalonate/homocysteine, 106–107  
 excess utilization/loss cause of  
   congestive heart failure/liver disease, 106  
   hematologic disorders, 105  
   homocystinuria, 106  
   infant prematurity, 105  
   inflammatory conditions, 105–106  
   long-term dialysis, 106  
   pregnancy, 105  
 general tissue effects of, 99–100  
 infancy/childhood and, 108  
 treatment of, 108
- Folic acid, 99, 108  
 long-term therapy of, 108  
 prophylactic, 108
- Folinic acid (leucovorin) (5-Formyl-THF), 106, 108, 484
- Follicle-stimulating hormone/luteinizing hormone (FSH/LH), 136
- Follicular lymphoma, 196  
 peripheral blood cell of, 67f  
 peripheral blood smear of, 196f  
 presentation for, 196  
 survival rate of, 197  
 treatment for, 196–197
- Follicular lymphoma-specific IPI (FLIPI), 191
- Follicular thyroid cancer (FTC), 571  
 incidence of, 575  
 mortality rates and, 575  
 spreading of, 575
- Fondaparinux, 251, 252, 259–260, 269, 273, 274–275  
 action mechanism of, 270f, 275, 692, 714  
 characteristics of, 700, 725  
 for HIT, 228, 275  
 LMWH v., 274t  
 pharmacology of, 275  
 side effects of, 275  
 for VTE, 275
- Food and Drug Administration (FDA), 167
- 5-Formyl-THF. *See* Folinic acid
- Foscarnet, for herpes viruses, 385t
- Franklin's disease. *See* Gamma heavy chain disease
- French-American-British (FAB)  
 AML classification by, 167, 167t  
 lymphoid malignancy classification by, 182
- Fresh-frozen plasma (FFP), 145
- FSH/LH. *See* Follicle-stimulating hormone/luteinizing hormone
- FTC. *See* Follicular thyroid cancer
- FTIs. *See* Farnesyltransferase inhibitors
- 5-FU. *See* 5-Fluorouracil
- Furosemide, 626
- Futile care, in palliative/end-of-life care, 415
- FVIII. *See* Factor VIII deficiency
- FXI. *See* Factor XI deficiency
- G6PD. *See* Glucose-6-phosphate dehydrogenase deficiency
- Gallbladder cancer (GB CA), 497–498
- Gamma heavy chain disease (Franklin's disease), 215
- Gamma rays, 347
- Gamma-carboxylase (GGCX), 240
- Ganciclovir, for herpes viruses, 385t
- Gardner's syndrome, 479, 499
- Gastrectomy  
 for carcinoid tumors, 589  
 cobalamin deficiency and, 103  
 as gastric adenocarcinoma treatment, 476
- Gastric acid hypersecretion, in gastrinoma, 590
- Gastric adenocarcinoma, 474  
 clinical features of, 475  
   spreading of, 475  
 diagnosis of, 475–477  
   gastroscopy for, 475  
   diffuse/intestinal type of, 474  
   etiology of, 474–475  
   nitrate converting bacteria and, 474–475, 475t  
   *H. pylori* and, 474  
 incidence/epidemiology of, 474  
 pathology of, 474  
 staging system for, 476t  
 treatment for, 476–477  
   gastrectomy, 476  
   radiation therapy, 476
- Gastric biopsy, 102
- Gastric cancer. *See* Gastrointestinal tract cancer
- Gastric carcinoids, 585
- Gastric (nonlymphoid) sarcoma, 477
- Gastrinoma, 590. *See also* Zollinger-Ellison syndrome  
 diagnosis of, 590  
   fasting gastrin and, 590  
 GERD and, 590  
 hypothyroidism and, 590  
 location of, 590  
 MEN1 and, 598  
 presenting symptoms of, 590  
 PUD and, 590  
 treatment of, 590–591  
   gastric acid hypersecretion and, 590
- Gastrin-releasing peptide (GRP), 440
- Gastroesophageal reflux disease (GERD), 590
- Gastrointestinal neuroendocrine tumor (GI NET)  
 characteristics of, 579t  
 syndromes for, 579–580t  
 tumor location and, 581t  
 WHO classification for, 582
- Gastrointestinal polyposis syndromes, hereditary, 479–480, 479t  
 HNPCC, 480  
 polyposis coli, 479–480
- Gastrointestinal stromal tumors (GISTs), 474  
 imatinib targeting, 300  
 soft tissue sarcomas and, 541
- Gastrointestinal tests, reference range of, 680–681t
- Gastrointestinal tract cancer, 472, 699, 724  
*See also* Esophageal cancer
- Gastrointestinal tract infections  
*clostridium difficile*-induced diarrhea and, 380  
 of esophagus, 379  
 hepatic candidiasis and, 379–380  
 of mouth, 378–379  
 typhlitis as, 380
- Gastroscopy, for gastric adenocarcinoma, 475
- Gaussian distribution, of hemoglobin concentration, 11
- GB CA. *See* Gallbladder cancer
- GBM. *See* Glioblastoma multiforme
- G-CSF. *See* Granulocyte colony-stimulating factor
- GCTs. *See* Germ cell tumors
- GDNF. *See* Glial cell-derived neurotrophic factor
- Gefitinib, 299t, 300, 358t, 649, 654
- Gemcitabine, 356t, 362, 496, 534  
 for soft tissue sarcoma, 543
- Gemcitabine, paclitaxel, and cisplatin (GTC), 507
- Gemtuzumab ozogamicin (Mylotarg), 175, 358t, 656
- Gene therapy, 94  
 for cancer treatment, 373  
 for sickle cell anemia, 88
- Genetics  
 adrenocortical tumors and, 617  
 breast cancer and, 288–289, 340, 459–460  
 cervical cancer and, 536  
 familial cancer syndromes and, 287t  
 FMTC mutations and, 503  
 of head/neck cancer, 438  
 of human hemoglobin, 82f, 83  
 MEN1 and, 600  
 NETs and, 582, 583t  
 ovarian cancer and, 531  
 pheochromocytoma and, 614–615  
 RCC and, 508–509  
 rearrangements of, 623  
 soft tissue sarcoma and, 541

- Genetics (*Cont.*):  
 testicular cancer and, 524  
 testing for familial cancer syndromes,  
 288–289, 289f  
 thyroid cancer and, 572–573  
 uterine cancer and, 535
- Geranylgeranyl transferase-I (GGT-1), 301
- GERD. *See* Gastroesophageal reflux disease
- Germ cell tumors (GCTs), 524  
 chemotherapy for, 527  
 extragonadal, 529  
 IGCCCG classification for, 528t  
 isochromosome for, 524  
 nonseminoma/seminoma subtypes of,  
 525–526  
 staging/treatment for, 525t
- German Adrenocortical Cancer Registry, on  
 adrenocortical tumor staging, 618
- Gerota's fascia, removal of, 509
- Gestational trophoblastic neoplasia, **538**  
 chemotherapy for, 539  
 clinical presentation for, 538–539  
 epidemiology of, 538  
 hydatidiform moles and, 538, 539  
 pathology/etiology of, 538  
 treatment for, 539
- Gfi-1 gene, absence of, 6
- GGCX. *See* Gamma-carboxylase
- GGOs. *See* "Ground-glass" opacities
- GGT-1. *See* Geranylgeranyl transferase-I
- Ghrelin, 594
- GHRH. *See* Growth hormone-releasing  
 hormone
- GI NET. *See* Gastrointestinal neuroendocrine  
 tumor
- Giant melanocytic nevus, 425
- Giant platelets, peripheral blood smear of, 62f
- GISTs. *See* Gastrointestinal stromal tumors
- Glanzmann's thrombasthenia, 231
- Gleason grading system, 516  
 for prostate cancer, 515
- Gleevec. *See* Imatinib mesylate
- Glial cell-derived neurotrophic factor  
 (GDNF), 602
- Glioblastoma multiforme (GBM), 549
- Gliomatosis cerebri, 551
- Glucagon, 627
- Glucagonoma  
 diagnosis of, 592  
 MEN1 and, 599  
 treatment for, 592
- Glucagonoma syndrome, 599
- Glucocorticoids, 48, 230, 406, 409, 697, 721  
 for acute necrotizing myopathy, 638  
 for AML, 174  
 for brain tumors, 548  
 as hormonal agent, 363  
 for IME, 160  
 for paraneoplastic cerebellar degeneration,  
 636
- Glucocorticoids (*Cont.*):  
 for SVCS, 643  
 for Sweet's syndrome, 378
- Glucose-6-phosphate dehydrogenase  
 deficiency (G6PD), 12, 116–117  
 clinical manifestations of, 118–119  
 CNSHA with, 119  
 drugs/agents increasing risk of, 119t  
 epidemiology of, 118, 118f  
 genetic considerations for, 117–118  
 hemolysis-mediated, 685, 706  
 laboratory diagnosis for, 119–120  
 peripheral blood smear of, 120f  
 treatment for, 120–121
- Glutathione peroxidase (GSHPx), 121
- Glutathione reductase pathway, 19
- Glutathione-S transferase T1 (GSTT1), 500
- Gluten-induced enteropathy, 104
- Glycolytic enzyme abnormality, 116
- Glycolytic pathway abnormality, 116
- Glycoprotein (GP), 265
- Glycosylphosphatidylinositol (GPI), 113
- Gompertzian growth curve, for tumors, 344,  
 344f
- Gonadal dysfunction, as chemotherapy  
 complication, 370
- GP. *See* Glycoprotein
- GPI. *See* Glycosylphosphatidylinositol
- GPIIb/IIIa receptor antagonists, 268–269  
 action mechanism of, 268–269  
 dosing for, 269  
 features of, 269t  
 indications for, 269  
 side effects of, 269  
 vWF and, 268
- Graft failure  
 hematopoietic stem cell transplantation  
 and, 393  
 treatment of, 393
- Graft-versus-Host disease (GVHD),  
 104, 149  
 acute v. chronic, 392  
 clinical staging/grading of, 392t  
 development/type of, 179  
 hematopoietic stem cell transplantation  
 and, 388–389, 392–393  
 prevention of, 392
- Graft-versus-leukemia (GVL), 174
- Graft-versus-tumor (GVT) effect, autologous  
 stem cell transplant lack of, 389
- Granules  
 azurophil/primary, 43  
 specific/secondary, 43
- Granulocyte colony-stimulating factor  
 (G-CSF), 4, 166, 389  
 administration of, 367  
 guidelines for, 367, 368t  
 infections and, 385
- Granulocyte/monocyte disorders, types of,  
 50t
- Granulocytes  
 mature, proliferation of, 4  
 normal, peripheral blood smear of,  
 62f
- Granulocytic sarcoma, 169
- Granulocytopenic patients  
 infections in, 377, 378t  
 pulmonary infections and, 381
- Granulocytosis, 628t  
 as asymptomatic, 629  
 cause of, 629  
 treatment not needed for, 629
- GRFomas  
 characteristics of, 594  
 commonality of, 594  
 median age for, 594
- "Ground-glass" opacities (GGOs), 451
- Growth hormone-releasing hormone  
 (GHRH), 599
- GRP. *See* Gastrin-releasing peptide
- GSHPx. *See* Glutathione peroxidase
- GSTT1. *See* Glutathione-S transferase T1
- GTC. *See* Gemcitabine, paclitaxel, and  
 cisplatin
- Guillain-Barré syndrome, 638
- GVHD. *See* Graft-versus-Host disease
- GVL. *See* Graft-versus-leukemia
- GVT. *See* Graft-versus-tumor effect
- Gynecologic malignancies, **530**. *See also*  
 Cervix cancer; Fallopian tube  
 carcinoma; Gestational trophoblastic  
 neoplasia; Ovarian cancer; Uterine  
 cancer  
 staging/survival in, 533t
- Gynecomastia, 520  
 hCG and, 627
- HA. *See* Hemolytic anemia
- Hairy cell leukemia, 199  
 INF- $\alpha$  for, 372
- Haldol. *See* Haloperidol
- Haloperidol (Haldol), 369, 407, 411
- Halotestin. *See* Fluoxymesterone
- Hamartoma, 457
- Hand-foot syndrome, 86
- Hapten, 121
- Haptocorrin (HC), 96
- Hasford system, for CML, 177
- Hashimoto's thyroiditis, 577
- HAV. *See* Hepatitis A virus
- HbF manipulation, 94
- HbH disease, 91
- HBV. *See* Hepatitis B virus
- HC. *See* Haptocorrin
- HCC. *See* Hepatocellular carcinoma
- hCG. *See* Human chorionic  
 gonadotropin
- HCV. *See* Hepatitis C virus
- HE. *See* Hereditary elliptocytosis
- H&E. *See* Hematoxylin and eosin

- Head/neck cancer, **438**  
 cervical adenopathy evaluation algorithm for, 435f  
 chemoprevention for, 437  
 classification of, 435  
 clinical presentation/differential diagnosis of, 439–440  
   physical examination of, 434–435  
 dietary factors and, 438  
 etiology/genetics of, 438  
 histopathology/carcinogenesis/molecular biology of, 439  
   mucosal surface and, 434  
   resected tumor specimens with, 434  
 incidence/epidemiology of, 438  
 late effects/consequences of, 661  
 TNM staging for, 436t  
 treatment for, 435–437  
   chemotherapy, 435  
   complications of, 437  
   concomitant chemoradiotherapy, 435–436  
   localized disease, 435  
   locally/regionally advanced disease, 435  
   for recurrent/metastatic disease, 437
- Hearing loss, 660
- Heavy chain disease, **215**  
 alpha heavy chain disease, 215–216  
 gamma heavy chain disease, 215  
 mu heavy chain disease, 216
- $\alpha$ -Heavy chain disease, 487
- Heinz bodies, 58, 89, 702, 728  
 peripheral blood smear of, 62f
- Helicobacter pylori*, 185, 194, 337, 499  
 aspirin and, 266  
 gastric adenocarcinoma and, 474  
 ITP and, 228
- Hemangiopericytoma, 544
- Hemarthroses, 27, 701, 726–727  
 prevalence of, 237  
 treatment for, 238
- Hematology, laboratory units/measurements of, 664–666t
- Hematopoiesis, 10
- Hematopoietic neoplasms, targeted therapies for, 364–366
- Hematopoietic stem cell(s), **2**, 388  
 cancer stem cells v., 309  
 cardinal functions of, 2–3  
   variable average life span of, 2–3  
 characteristics of, 699, 724  
 circulation of, 3  
 developmental biology of, 3  
 distinct governing mechanisms of, 4  
 excess capacity of, 4  
   disease's influence on, 4  
 experimental data on, 7  
 functions of  
   differentiation, 2, 3f, 4–5  
   self-renewal, 2, 3f
- Hematopoietic stem cell(s) (*Cont.*):  
 healing capacity of, 7  
 importance of, 2  
 infection and, 383  
 life threatening potential of, 7  
 microenvironment of, 3–4  
 mobility of, 3  
 potential fates of, 5  
 recovery of, 3  
 research on, 2  
 umbilical cord blood supplying, 6
- Hematopoietic stem cell transplantation, 123, 134–135, **388**  
 5-year survival rate following, 394t  
 bone marrow collection for, 390–391  
 categories of, 388–390  
   allogeneic, 389  
   autologous, 389–390  
 complications following, 391–394  
   chemoradiotoxicities, early direct, 391–392  
   chemoradiotoxicities, late direct, 392  
   graft failure, 393  
   GVHD, 392–393  
   infection, 393–394, 393t  
 engraftment and, 391  
 GVHD and, 388–389  
 liver dysfunction from, 659  
 for lymphoma, 396  
 major syndromes complicating, 391f  
 for MDS, 141, 396  
 for myeloma, 396  
 peripheral blood cell collection for, 391  
 for posttransplant relapse, 396  
 preparative regimen for, 390–394  
   disease setting/marrow source influencing, 390  
   procedure of, 390–391  
 rejection risk of, 389  
 for solid tumors, 396  
 specific diseases treated by, 394–396  
   AA, 394  
   hemoglobinopathies, 394–395  
   malignant diseases, 395–396  
   nonmalignant diseases, 395  
   umbilical cord blood used in, 388, 390
- Hematoxylin and eosin (H&E), 17
- Hematuria, bladder cancer and, 505
- Heme-heme interaction, 82
- Hemicolectomy, 589
- Hemoglobin  
 concentration of  
   Gaussian distribution of, 11  
   pregnancy/age changes and, 13t  
 function of, 82–83  
   cooperativity/heme-heme interaction, 82  
 high-/low-affinity, 89
- Hemoglobin (*Cont.*):  
 human  
   developmental biology of, 83  
   genetics/biosynthesis of, 82f, 83  
   oxygen acquisition and, 82–83  
   oxygen affinity of, 83  
   altered, 89  
   profile quantitation of, 84–85  
   structurally abnormal, 85–90
- Hemoglobin disorders, **81**
- Hemoglobin E (HbE), 92–93
- Hemoglobin properties, **81**  
 globin genes of, 81, 82f  
 hemoglobin-oxygen dissociation curve as, 82f  
 structure of, 81–82  
   HbF/HbA<sub>2</sub>, 81  
   quaternary, 81  
   secondary, 81  
   tertiary, 81
- Hemoglobin synthesis (hypochromia), 11
- $\alpha$ -Hemoglobin-stabilizing protein (AHSP), 83
- Hemoglobinemia, color serum in, 68f
- Hemoglobinopathies  
 aplastic/hypoplastic crisis in, 94  
 classification of, **83**, 84t  
   acquired, 84  
   HPFH, 84  
   structural, 83  
   thalassemias, 83  
 detection/characterization of, 84–85  
   electrophoretic assessment for, 85  
   laboratory evaluation for, 85  
 epidemiology of, 84  
 experimental therapies for, 94  
 hematopoietic stem cell transplantation for, 394–395  
 inheritance/ontogeny and, 84
- Hemolysis, 18  
 diseases/clinical situations with, 120t  
 extravascular, 123  
 G6PD-mediated, 685, 706  
 HA v. compensated, 112–113  
 intravascular, 123
- Hemolytic anemia (HA), **110**  
 from abnormal membrane-cytoskeleton complex, 113, 113f  
 acquired, 121  
   from infection, 122  
   from red cell mechanical destruction, 121  
   from toxic agents/drugs, 121–122  
 classification of, 111t, 695, 718  
 clinical/laboratory features of, 110–111, 111t  
 compensated hemolysis v., 112–113  
 enzyme abnormalities and, 116–117, 117t  
 erythropoietic bone marrow response of, 111

- Hemolytic anemia (HA) (*Cont.*):  
 inherited, 113  
 jaundice and, 110  
 laboratory values for, 692, 714  
 pathophysiology of, 111–113  
   differentiation and, 111  
 types of, 110
- Hemolytic disease, 19, 112  
 differential diagnosis of, 20
- Hemolytic disease of newborn. *See* Hydrops fetalis
- Hemolytic uremic syndrome (HUS), 229, 230–231  
 ADAMTS13 activity and, 230, 231, 654  
 chemotherapy-related, 654  
 fatality rate of, 654  
 laboratory findings of, 653  
 as oncologic emergency, 653–654  
 onset of, 653  
 pathologic lesion of, 653–654  
 treatment for, 231, 654
- Hemophilia, **236**  
 antifibrinolytic drugs for, 238  
 bleeding and, 237  
 HCV and, 239  
 nontransfusion therapy in, 238  
 pathogenesis/clinical manifestations of, 236–237  
 treatment for, 237–239  
   complications of, 238–239  
   factor replacement therapy, 237  
   general considerations for, 237
- Hemophilia A, 235, 685, 705. *See also* Factor VIII deficiency  
 DDAVP for, 238  
 genetic mutation for, 236
- Hemophilia B, 235. *See also* Factor IX deficiency
- Hemoptysis  
 as oncologic emergency, 650  
 pulmonary hemorrhage and, 650  
 recurrent, 650  
 treatment of, 650
- Hemorrhagic cystitis  
 development of, 656  
 occurrence of, 656  
 as oncologic emergency, 656  
 treatment for, 656
- Hemosiderin, 17
- Hemostasis, normal steps of, 22–25  
 antithrombotic mechanisms and, 24–25  
 fibrin clot formation and, 23  
 fibrinolytic system and, 25  
 platelet plug formation and, 22
- Hemostatic disorders, primary, 26f
- Heparin, 242, 269–273, 630. *See also*  
 Low-molecular-weight heparin;  
 Unfractionated heparin  
 action mechanism of, 269–270, 270f  
 anticoagulant effect monitoring of, 271
- Heparin (*Cont.*):  
 bivalirudin v., 276  
 dosing of, 271  
 limitations of, 271  
   pharmacokinetic/biophysical, 271t  
 LMWH v., 273t  
 pharmacology of  
   anticoagulation response of, 270–271  
   binding of, 270  
   clearance of, 270  
 side effects of  
   bleeding, 272  
   HIT, 272–273  
   osteoporosis, 273  
   transaminases level elevation, 273  
 TFPI from, 270
- Heparin-induced thrombocytopenia (HIT), 227–228, 260, 272–273, 691, 712  
 argatroban for, 276  
 features of, 272t  
 fondaparinux and, 275  
 laboratory testing for, 228  
 lepirudin for, 275  
 from LMWH, 274  
 management of, 272t  
 time course of, 227f  
 treatment for, 228, 695, 718–719
- Heparin-induced thrombocytopenia thrombosis (HITT), 227
- Hepatic candidiasis, 379–380
- Hepatitis A virus (HAV), 150–151
- Hepatitis B virus (HBV), 150, 489, 694, 717
- Hepatitis C virus (HCV), 150, 489, 701, 727  
 hemophilia treatment and, 239
- Hepatocellular carcinoma (HCC), **489**  
 age-adjusted incidence rates for, 489t  
 cirrhosis-associated, 490  
 clinical evaluation for, 496  
 clinical features of, 490–491  
   paraneoplastic syndromes, 491  
   physical signs, 491  
 clinical presentation of, 491  
 epidemiology of, 490  
 etiologic factors of, 490  
   chemical carcinogens, 490  
   hepatitis, 490  
 history/physical examination of, 496  
 incidence of, 489–490, 685, 705  
 novel medical treatments for, 496t  
 patient approach and, 492–493  
   history/physical, 492  
   pathologic diagnosis, 492–493  
   radiology, 492  
   serologic assays, 492  
 presentation of, 496  
 randomized TACE clinical trials involving, 495t  
 risk factors for, 490t, 685, 705  
 screening high-risk populations for, 493
- Hepatocellular carcinoma (HCC) (*Cont.*):  
 stage I/II treatment for  
   adjuvant therapy, 494  
   liver transplantation, 494  
   local ablation strategies, 494  
   local injection therapy, 494  
   surgical excision, 494  
 stage III/IV treatment for, 494–496  
   experimental therapies, 495–496  
   regional chemotherapy, 495  
   systemic chemotherapy, 495  
 staging for, 491–492, 493  
 therapy for, 496  
 treatment for, 493–496, 695–696, 719  
   algorithm for, 493t
- Hepatosplenic  $\gamma\delta$  T cell lymphoma, 202
- Hephaestin, 72
- HER2/*neu*, breast cancer target and, 300
- Herbicides, 167
- Herceptin. *See* Trastuzumab
- Hereditary gastrointestinal polyposis syndromes. *See* Gastrointestinal polyposis syndromes, hereditary
- Hereditary chronic pancreatitis, 499
- Hereditary elliptocytosis (HE), 113, 115–116, 115t  
 peripheral blood smear of, 114f
- Hereditary hemorrhagic telangiectasia, 234
- Hereditary neutropenia, Felty's syndrome and, 48–49
- Hereditary nonpolyposis colon cancer (HNPCC), 480, 499–500  
 as familial cancer syndrome, 287, 696, 719
- Hereditary persistence of fetal hemoglobin (HPFH), 84, 93
- Hereditary spherocytosis (HS), 113–115, 689, 708  
 clinical presentation/diagnosis of, 114–115  
 variability of, 114  
 family history for, 114–115  
 peripheral blood smear of, 114f  
 splenectomy and, 115  
 treatment of, 115
- Hereditary thrombophilia, 248–249
- Hermansky-Pudlak syndrome, 231
- Herpes virus, antiviral therapy for, 385, 385t
- HHM. *See* Humoral hypercalcemia of malignancy
- HIF. *See* Hypoxia-inducible factor
- High-affinity hemoglobins, 89  
 diagnosis/management of, 89–90
- High-grade astrocytoma, 551  
 alternative treatment approach to, 551  
 radiation therapy and, 551
- High-pressure liquid chromatography (HPLC), 84
- Hirschsprung's disease, 288, 601, 602
- Hirudin, bivalirudin/argatroban v., 275t

- Histone acetylases  
 cancer cell biology and, 303  
 permissive/inhibitory chromatin structure and, 303
- HIT. *See* Heparin-induced thrombocytopenia
- HITT. *See* Heparin-induced thrombocytopenia thrombosis
- HIV. *See* Human immunodeficiency virus
- HIV-1. *See* Human immunodeficiency virus type 1
- HLA. *See* Human leukocyte antigen
- HNPCC. *See* Hereditary nonpolyposis colon cancer
- Hodgkin's disease, 202–204  
 Ann Arbor staging system for, 190t  
 classical type, 202–203  
 diagnosis of, 202  
 evaluation of, 190  
 high cure rate of, 203  
 incidence of, 184–185  
 late effects/consequences of, 661  
 NHL increased risk from, 660  
 nodular lymphocyte-predominant, 203–204  
 nodular sclerosing, 67f  
 peripheral blood smear of, 67f  
 presentation of, 202  
 prognosis of, 696, 719–720  
 staging evaluation for, 202  
 treatment for, 202–203  
 relapse after, 203  
 side effects of, 203
- Home Care Guide for Cancer: How to Care for Family and Friends at Home* (American College of Physicians), 330
- Homeobox “hox” genes, 6–7
- Homocysteine, 106
- Homocystinuria, 106
- Hormonal agent  
 for chemotherapy, 363–364  
 glucocorticoids as, 363
- Hormone replacement therapy (HRT)  
 breast cancer and, 460–461  
 for prostate cancer, 520  
 second malignancies caused by, 661
- Horner's syndrome, 443
- Horse antithymocyte globulin, 135
- Hospice  
 domains of, 399  
 enrollment length in, 419  
 existential/social needs and, 400  
 palliative care and, 399  
 for terminally ill patients, 419
- Howell-Jolly bodies, 13, 57, 702, 728  
 peripheral blood smear of, 14f, 61f
- Hox genes. *See* Homeobox “hox” genes
- HPFH. *See* Hereditary persistence of fetal hemoglobin
- HPLC. *See* High-pressure liquid chromatography
- HPV. *See* Human papillomavirus
- HRT. *See* Hormone replacement therapy
- HS. *See* Hereditary spherocytosis
- HSR. *See* Hypersensitivity reactions
- HTLV-I. *See* Human T cell lymphotropic virus type I
- Human antibody infusion reactions  
 as oncologic emergency, 653  
 pathogenesis of, 653  
 symptoms of, 653
- Human chorionic gonadotropin (hCG), 525, 627  
 gynecomastia and, 627  
 levels before/after orchiectomy, 526  
 measurement of, 627, 693, 715  
 treatment for, 627
- Human immunodeficiency virus (HIV), 104
- Human immunodeficiency virus type 1 (HIV-1), 150
- Human iron cycle, 70–72  
 distribution of, 71t  
 exchange mechanism of, 71  
 major pathways of, 71f
- Human leukocyte antigen (HLA), 134
- Human papillomavirus (HPV), 337, 438  
 cervix cancer and, 536
- Human T cell lymphotropic virus type I (HTLV-I), 151, 185
- Humoral hypercalcemia of malignancy (HHM), 623  
 clinical manifestations of, 624  
 diagnosis of, 624–625  
 treatment of, 625  
 dialysis for, 625  
 excess calcium removal and, 625  
 tumor-mediated production and, 623
- HUS. *See* Familial hemolytic uremic syndrome; Hemolytic uremic syndrome
- Hydatidiform moles, gestational trophoblastic neoplasia and, 538, 539
- Hydrocephalus, 559
- 4-Hydroperoxycyclophosphamide, 389
- Hydrops fetalis, 143
- Hydroxocobalamin, 107
- Hydroxyurea, 88, 163, 356t
- Hypercalcemia, paraneoplastic, 594, 651, 686, 706
- HyperC-VAD. *See* Cyclophosphamide, vincristine, doxorubicin, dexamethasone, cytarabine, and methotrexate
- Hypereosinophilic syndrome, 55
- Hyperimmunoglobulin E-recurrent infection syndrome (Job's syndrome), 52t, 55
- Hyperleukocytosis, 649, 688, 709
- Hyperparathyroidism, 602. *See also* Primary hyperparathyroidism  
 treatment for, 605
- Hyperphosphatemia, 652
- Hyperplasia, 38  
 MEN1 and, 598
- Hypersensitivity reactions (HSR), to antineoplastic drugs, 656
- Hypersplenism, 38
- Hypertension, 610
- Hypertrophy, 38
- Hyperuricemia, TLS and, 652
- Hyperviscosity, 210
- Hypoaminoacidemia, 592
- Hypochondria, 35
- Hypochromia. *See* Hemoglobin synthesis
- Hypochromic, 57
- Hypochromic microcytic anemia of iron deficiency, 59f
- Hypoglycemia, 651  
 autoimmune insulin syndrome with, 608  
 tumor-induced, by IGF-II production, 627
- Hypometabolic state anemia  
 from endocrine/nutritional deficiency, 79  
 from protein starvation, 79
- Hyponatremia, ectopic vasopressin and, 625
- Hypophosphatemic oncogenic osteomalacia, 628  
 treatment for, 628
- Hypoplastic crisis, 94
- Hypoproliferation, 18
- Hypoproliferative anemia, 18–19, 70, 77  
 from chronic inflammation, 77–78  
 diagnosis of, 78t  
 endocrine/nutritional deficiencies and, 77  
 marrow damage and, 77  
 renal disease and, 77, 78  
 treatment for, 79–80  
 EPO, 79–80  
 red cell transfusions, 79
- Hyposplenism, from splenectomy, 40
- Hypothermia, transfusion therapy and, 150
- Hypothyroidism  
 antityroxine antibodies and, 608  
 gastrinoma and, 590
- Hypovolemia, 11
- Hypoxemia, 11
- Hypoxia-inducible factor (HIF), 302
- Hysterectomy, total, for ovarian cancer, 532
- I system, 145
- IBD. *See* Inflammatory bowel disease
- IBIS-I. *See* International Breast Cancer Intervention Study
- Ibuprofen, for pain intervention, 405
- ICOPER. *See* International Cooperative Pulmonary Embolism Registry
- ICP. *See* Intracranial pressure
- ICU. *See* Intensive care unit
- Idarubicin, 171, 355t
- Idiopathic myelofibrosis (IMF), 154, 158, 692, 694–695, 713, 717  
 clinical features of, 158–159  
 complications of, 159

- Idiopathic myelofibrosis (IMF) (*Cont.*):  
 diagnosis of, 159  
 disorders causing, 158t  
 etiology of, 158  
 peripheral blood smear of, 158f  
 risk stratification for, 160t  
 treatment of, 159–160
- IFN- $\alpha$ . *See* Interferon- $\alpha$
- Ifosfamide, 354t, 543, 544, 545
- IGCCCG. *See* International Germ Cell Cancer Consensus Group
- IGF. *See* Insulin-like growth factor
- IL-1. *See* Interleukin 1
- IL-1 receptor-associated kinase 4 (IRAK4), 53
- Ileal resection, cobalamin deficiency and, 103
- Imatinib mesylate (Gleevec), 299t, 358t, 359, 395, 487, 543, 649, 654, 698, 722  
 for allogeneic posttransplantation treatment, 179  
 BCR-ABL target by, 297–300  
 clinical studies on, 298–299  
 for CML, 177, 178t, 179–180  
 IFN- $\alpha$  v., 181  
 relapse during treatment with, 299  
 resistance to, 179  
 side effects of, 179  
 sunitinib v., 300  
 target/genetic proof of, 299–300, 364
- IMF. *See* Idiopathic myelofibrosis
- Imiquimod, for NMSC, 430
- Immune system  
 biologic therapy and, 371–373  
 cancer treatment suppression of, 371  
 tumor avoidance of, 371
- Immune thrombocytopenic purpura (ITP), 228–229  
 bleeding and, 228  
*Helicobacter pylori* and, 228  
 laboratory testing in, 228–229  
 treatment of, 229  
 hospitalization, 229  
 new drugs for, 229  
 splenectomy, 229
- Immune tolerance induction (ITI), 239
- Immunoglobulins  
 allotypes of, 205  
 idiotypes of, 205  
 isotypes of, 205
- Immunohistochemical analysis, CUP pathologic diagnosis and, 563–564, 564t
- Immunologic syndromes, multiple endocrine organs influenced by, 605–608  
 antibiotic insulin resistance, 607  
 antithyroxine antibodies/hypothyroidism, 608  
 autoimmune insulin syndrome, 608  
 Crow-Fukase syndrome, 608  
 PGA type I, 606  
 PGA type II, 606–607
- Immunology, laboratory units/measurements of, 666–672t
- Immunomodulation, 150
- Immunoproliferative small intestinal disease (IPSID), 216, 487
- Impotence, prostate cancer and, 516
- Incisional biopsy, 345
- Indomethacin, 593
- Infantile poikilocytosis, 121
- Infection(s)  
 anemia from, 78  
 antibiotics for, 374  
 brain masses as, 380  
 in cancer patients, **374**  
 antibacterial therapy for, 383–384  
 antifungal therapy for, 384–385  
 antiviral therapy for, 385  
 prevention of, 386–387  
 treatment for, 383–386  
 catheter-related, 378  
 approach to, 379t  
 death from, 374  
 early antibiotics for, 374  
 encephalitis as, 380  
 of esophagus, 379  
 G-CSF and, 385  
 in granulocytopenic patients, 377, 378t  
 hematopoietic stem cell transplantation complication as, 393–394, 393t  
 of lower gastrointestinal tract, 379–380  
 lymph node integrity and, 374  
 meningitis as, 380  
 of mouth, 378–379  
 as oncologic emergency, 654  
 physical predisposition to, 374, 375t  
 predisposition abnormalities for, 383  
 hematopoietic system, 383  
 lymphoid system, 383  
 prevention of, 386–387  
 antibiotic prophylaxis as, 387  
 environmental effect on, 386  
 immunoglobulin replacement, 387  
 physical measures for, 386–387  
 sexual practices and, 387  
 vaccination as, 387  
 specific cancers associated with, 375, 376t  
 splenectomy and, 374–375, 702, 728  
 system-specific syndromes and, 377–383  
 cardiovascular, 382  
 catheter-related, 378  
 central nervous, 380, 381t  
 endocrine, 382  
 gastrointestinal tract, 378–380  
 musculoskeletal, 382  
 pulmonary, 380–382  
 renal/ureteral, 383  
 skin, 377–378
- Infection-induced thrombocytopenia, 225–226
- Inferior vena caval (IVC) filters, 261
- Inflammatory bowel disease (IBD), colorectal cancer and, 480
- Inflammatory disorders of vessel walls, 233–234
- Inherited disorders of platelet function, 231  
 treatment for, 231
- Inherited disorders of vessel wall, 234
- Inherited thrombocytopenia, 229
- Inhibitors  
 clinical diagnosis of, 238  
 for coagulation, 235  
 coagulation factors and, 244  
 formation of, hemophilia treatment and, 238  
 replacement of, 242–243
- INR. *See* International normalized ratio
- Insomnia, in palliative/end-of-life care assessment for, 412  
 etiology of, 412  
 frequency of, 412  
 interventions for, 412
- Institute of Medicine, 657
- Insulin resistance  
 by antibodies, 607–608  
 colorectal cancer and, 479
- Insulin-like growth factor (IGF)  
 bioavailability of, 627  
 soft tissue sarcoma producing, 541  
 tumor-induced hypoglycemia from production of, 627
- Insulinomas, 591, 594  
 diagnosis of, 591  
 MEN1 and, 599  
 suspicion for, 591  
 treatment of, 591
- Intensive care unit (ICU), 400
- Interferon- $\alpha$  (IFN- $\alpha$ ), 177, 180, 197, 208, 409, 428  
 for hairy cell leukemia, 372  
 imatinib v., 181
- Interleukin 1 (IL-1), 77
- Internal tandem duplications (ITDs), 168
- International Agency for Research on Cancer, 439
- International Bone Marrow Transplant Registry, 388
- International Breast Cancer Intervention Study (IBIS-I), 336
- International Cooperative Pulmonary Embolism Registry (ICOPER), 254
- International Federation of Gynecologists and Obstetricians (FIGO), 325
- International Germ Cell Cancer Consensus Group (IGCCCG), GCT classification by, 527
- International normalized ratio (INR), 29, 630, 689, 709  
 for argatroban, 276  
 for warfarin, 277

- International Prognostic Index (IPI)  
for NHL, 190t  
survival relationship with, 191f
- International Scoring System, for MDS, 141, 141t
- International sensitivity index (ISI), 29, 277
- International System (SI) unit, for radiation therapy, 348
- Intestinal obstruction  
as oncologic emergency, 645  
onset of, 645  
prognosis of, 645  
surgery for, 645  
treatment for, 645
- Intestinal stagnant loop syndrome, 103
- Intracranial pressure (ICP)  
from brain tumors, 548  
increase of  
as oncologic emergency, 648  
signs/symptoms of, 648  
treatment for, 648
- Intraperitoneal (IP) chemotherapy, 533
- Iodine 131  
ablation, 576  
for thyroid cancer, 348
- Ionization, 347
- IP. *See* Intraperitoneal chemotherapy
- IPEX syndrome, 607
- IPI. *See* International Prognostic Index
- IPSID. *See* Immunoproliferative small intestinal disease
- IRAK4. *See* IL-1 receptor-associated kinase 4
- Irinotecan (CPT-II), 355t, 476, 484–485, 649
- Iron  
absorption of, 72–73  
from diet, 72  
distribution of, 71t  
half-clearance time of, 71  
laboratory studies of, 74–75  
bone marrow iron store evaluation, 74  
serum ferritin, 74  
serum iron/TIBC, 74  
overload of, from transfusion therapy, 150  
red blood cell content of, 71  
role of, 70  
supplements for, 72  
as toxic, 70
- Iron deficiency  
causes of, 73, 74t  
clinical presentation of, 73–74  
differential diagnosis for, 75  
laboratory studies of, 73f  
prevalence of, 73  
stages of, 73  
iron-deficiency anemia, 73  
iron-deficient erythropoiesis, 73  
negative iron balance, 73
- Iron dextran, 77
- Iron metabolism, 70  
exchange mechanism of, 71, 71f  
iron cycle, in humans, 70–72
- Iron reutilization, 77
- Iron supply/storage  
bone marrow evaluation of, 74–75  
measurements of, 75t  
tests for, 16  
Prussian blue staining, 65f
- Iron therapy  
oral, 76, 76t  
parenteral, 76–77  
dose calculation for, 77
- Iron tolerance test, 76
- Iron-deficiency anemia, 19, 695, 718  
as iron deficiency stage, 73  
normal red blood cells v., 59f  
severe, peripheral blood smear of, 14f  
treatment for, 75–777  
oral iron therapy, 76, 76t  
parenteral iron therapy, 76–77  
red cell transfusion, 76
- Iron-deficient erythropoiesis, 73
- ISI. *See* International sensitivity index
- Islet cell adenoma, 485–486
- Islet cell tumors, 581  
diabetes mellitus and, 601  
diagnosis of, 599  
treatment for, 601  
chemotherapy for, 601
- ITDs. *See* Internal tandem duplications
- ITI. *See* Immune tolerance induction
- ITP. *See* Immune thrombocytopenic purpura
- IVC. *See* Inferior vena caval filters
- JAK kinase, 155
- Jaundice, 686, 707  
HA and, 110
- JCAHO. *See* Joint Commission on the Accreditation of Health Care Organization
- Job's syndrome. *See* Hyperimmunoglobulin E-recurrent infection syndrome
- Joint Commission on the Accreditation of Health Care Organization (JCAHO), 404
- Juvenile pernicious anemia, 103
- Juvenile pilocytic astrocytoma, 549
- Kaposi's sarcoma, 431, 541
- Karnofsky performance index, 325, 325t, 507, 550
- Kearns-Sayre syndrome, 607
- Keratoacanthoma, skin lesion of, 429f
- Ketoconazole, 627
- Ketorolac, 88
- Kidd antigens, 145
- Klinefelter's syndrome, 524
- Knudson hypothesis, 286
- Kostmann's syndrome, 395
- Laboratory tests  
for hematology/coagulation, 664–666t  
radiation-derived units from, 683t  
reference values for, 664  
units/measurements in, 663
- Lactate dehydrogenase (LDH), 148, 525  
levels before/after orchiectomy, 526
- Lactic acidosis, 651
- Lacunar cell, peripheral blood smear of, 67f
- LAD. *See* Leukocyte adhesion deficiency
- Lambert-Eaton myasthenic syndrome (LEMS), 631
- Laminectomy, for spinal cord compression, 647
- Laminin, 43
- Lamotrigine, 406
- Lanreotide, 592
- LAP. *See* Leukocyte alkaline phosphatase
- Large cell carcinoma, 439
- Large granular lymphocytes (LGLs), 48, 58
- Large-bowel cancer detection, screening and, 481–482
- Late effects/complications from cancer, 659  
cardiovascular system and, 659, 689, 710  
consequences of, 661–662  
acute leukemia, 661  
breast cancer, 661–662  
colorectal cancer, 662  
head/neck cancer, 661  
Hodgkin's disease, 661  
NHL, 661  
pediatric cancers, 661  
prostate cancer, 662  
SCT, 661  
testicular cancer, 662  
outlook on, 662  
second malignancies as, 660–661  
from chemotherapy, 660–661  
from HRT, 661  
from primary cancer, 660–661  
from radiation therapy, 660–661
- L-carnitine, 409
- LCR. *See* Locus control region
- LCs. *See* Light chains
- LDH. *See* Lactate dehydrogenase
- Lead poisoning, stippled red blood cells in, 62f
- Lead-time bias, 338, 690, 712
- Left upper quadrant (LUQ), 35
- Leiomyomas, as benign small intestine tumors, 486
- Leiomyosarcoma, 487
- LEMS. *See* Lambert-Eaton myasthenic syndrome
- Lenalidomide, 141  
for multiple myeloma, 213

- Length-biased sampling, 338, 690–691, 712
- Lentigo maligna melanoma, 422–423, 423f
- Lepirudin, 275–276  
for HIT, 228, 275
- Leptomeningeal lymphoma, 554
- Leptomeningeal metastases, 558–559, 559t  
clinical features of, 558–559  
laboratory/imaging evaluation for, 559  
treatment for, 559
- Lethal midline granuloma, 201
- Leucovorin (LV), 485, 544. *See also* Folinic acid
- Leukapheresis, for CML, 180
- Leukemic meningitis, 559
- Leukemoid reaction, 49
- Leukocyte adhesion deficiency (LAD), 49, 51t
- Leukocyte alkaline phosphatase (LAP), 155
- Leukocytostasis, pulmonary/intracerebral, 649–650  
frequency of, 649  
presentation of, 650  
treatment for, 650
- Leukoerythroblastosis, 142
- Leviractam, 548
- Levothyroxine, 575
- Lewis system, 144
- LGLs. *See* Large granular lymphocytes
- Lhermitte's syndrome, 203, 646
- LHRH. *See* Luteinizing hormone-releasing hormone
- Lidamide, 593
- Life-sustaining treatment  
terminal extubation/weaning of, 414  
withdrawing/withholding of, 414–415  
legal aspects of, 414  
practices of, 414–415
- Li-Fraumeni syndrome, 541, 617
- Light chains (LCs), 217  
in AL amyloidosis, 220
- Limbic encephalitis, 632–633, 634, 634f
- Limited-stage disease, lung cancer and, 445
- Lipiodol, 492. *See also* Ethiodol
- Lipomas, as benign small intestine tumors, 486
- Liposomal amphotericin, for AML, 173
- Lithium, 593
- Liver disease  
anemia in, 79  
coagulation disorders associated with, **243**  
DIC v., 701–702, 727  
hemostasis/coagulation disorders and, 244
- Liver dysfunction, 659
- Liver transplantation  
for HCC, 494  
for NETs, 596
- Liver tumors  
benign, 498  
metastatic, 498  
presence/effect of, 595f
- Living wills, as advance care planning document, 402
- LMWH. *See* Low-molecular-weight heparin
- Lobectomy, for thyroid cancer, 575
- Locus control region (LCR), 83
- Loeffler's endocarditis, 55
- LOH. *See* Loss of heterozygosity
- Lomustine (CCNU), 354t, 551
- Loperamide, 588, 593
- Lorazepam (Ativan), 369, 407, 412
- Loss of heterozygosity (LOH), 286
- Low-affinity hemoglobins, 89
- Low-grade astrocytoma, 550  
median overall survival rate of, 550
- Low-molecular-weight heparin (LMWH), 31, 227, 259, 269, 273–274  
action mechanism of, 270f, 273  
contraindication for, 689, 710  
dosing of, 274  
for DVT, 251  
fondaparinux v., 274t  
heparin v., 273t  
monitoring of, 274  
pharmacology of, 273  
bioavailability of, 273  
clearance of, 273  
side effects of, 274  
bleeding, 274  
HIT, 274  
osteoporosis, 274  
use of, 691, 712
- L-phenylalanine mustard, 213
- Lung cancer, **439**  
biology/molecular pathogenesis, 441–443  
dominant oncogene activation, 441–442  
molecular abnormalities, 442–443  
molecular profile survival/response prediction, 443  
tumor-suppressor gene inactivation, 442  
bronchial adenomas and, 457  
carcinoid/neuroendocrine tumors and, 457  
cigarette smoking and, 440  
clinical manifestations of, 443–444  
Eaton-Lambert syndrome, 444  
endocrine syndromes, 444  
extrathoracic metastatic disease, 443  
Horner's syndrome, 443  
neurologic-myopathic syndromes, 444  
Pancoast's syndrome, 443  
paraneoplastic syndromes, 443  
skeletal-connective tissue syndromes, 444  
SVCS, 443  
diagnosis for, 444–445  
establishment of, 445  
EGFR mutations of, 300  
etiology of, 441  
frequency/incidence/survival rates of, 440t  
hamartomas and, 457  
incidence of, 439  
inherited predisposition to, 442
- Lung cancer (*Cont.*):  
limited/extensive-stage disease and, 445  
metastatic pulmonary tumors and, 457–458  
pathology of, 439–440  
treatment based on, 440  
prevention of, 456  
screening for, 341, 444–445  
staging for, 445  
lymph node stations for, 448f  
NSCLC, 445  
SCLC, 445  
staging procedures for, 445–448  
CT/chest radiographs, 445–446  
false negatives, 445  
physiologic staging and, 449  
for pretreatment, 447t  
TNM staging system for, 446t  
treatment of, 449–456, 450t  
NSCLC, 451–455  
SCLC, 455–456  
SPN/"ground-glass" capacity, 449–451  
stage occult/o, 449
- Lung neoplasms, benign, 456–457
- Lung scanning, 257–258
- Lupus anticoagulants, 30, 691, 712
- LUQ. *See* Left upper quadrant
- Luteinizing hormone-releasing hormone (LHRH), 364
- LV. *See* Leucovorin
- Lymph nodes  
biopsy indications of, 35  
Burkitt's syndrome in, 67f  
diffuse large B cell lymphoma in, 67f  
infection from integrity of, 374  
for lung cancer staging, 448f  
non superficial presentations of, 34  
regional draining of, to testis, 525  
RPLND of, 526  
sampling of, 345  
size/texture of, 35
- Lymphadenopathy, **32**, 192, 702, 728  
clinical assessment for, 32–34  
medical history for, 32–33  
physical examination for, 33  
diseases associated with, 33t  
laboratory investigation for, 34–35  
chest x-ray, 34  
fine needle aspiration, 35  
ultrasonography, 34–35  
management of, 702, 728
- Lymphoblastic leukemia, acute, peripheral  
blood smear of, 66f
- Lymphocytes. *See also* Large granular lymphocytes  
reactive, 58
- Lymphoid cells  
infection and, 383  
macrophage interaction with, 54f  
proliferation of, 4



- Lymphoid disorders, chronic lymphoid leukemia confused with, 183t
- Lymphoid leukemia, chronic. *See* Chronic lymphoid leukemia
- Lymphoid malignancies
- approach to patient with, 188–191
    - initial evaluation and, 188–189
  - B cell differentiation and, 186–187, 187f
  - biology of, 182–184
  - cell-surface phenotyping and, 186
  - clinical features/treatment/prognosis of, 191–204
  - cytogenetic translocation/oncogenes in, 188t
  - diseases increasing risk of, 186t
  - gene profiling and, 188
  - general aspects of, 184–191
    - etiology/epidemiology of, 184–186
    - immunology of, 186–188
    - relative frequency of, 184f
  - infectious agents associated with, 185t
  - lymphoma like disorders and, 204
  - recurring genetic abnormalities and, 186–187
  - T cell differentiation and, 187, 188t
  - WHO classification of, 182–184, 183t
- Lymphoma
- of bone marrow, 64f
  - erythrophagocytosis with, 67f
  - hematopoietic stem cell transplantation for, 396
  - primary CNS, 553–554, 553f
  - secondary CNS, 554
  - as small intestine tumors, 486–487
    - carcinoid tumors as, 487
    - leiomyosarcoma as, 487
  - of thyroid, 577
- Lymphomatoid papulosis, 204
- Lymphomatous meningitis, 559
- Lymphoplasmacytic lymphoma, 199
- Lynch syndrome, 535, 660, 719
- Lys-plasminogen, 280
- M component. *See* Monoclonal component
- Macrocytosis, 13
- peripheral blood smear of, 14f, 59f
- Macrophage
- immune response and, 53
  - lymphoid cell interactions with, 54f
  - role of, 53
  - types of, 53
- MAG. *See* Myelin-associated glycoprotein
- Magnetic resonance (MR), 258, 500
- Magnetic resonance cholangiopancreatography (MRCP), 500
- Malignant biliary obstruction
- as oncologic emergency, 645–646
  - treatment for, 646
  - tumors causing, 646
- Malignant fibrous histiocytoma, 544
- Malignant spinal cord compression (MSCC), 559, 699, 724. *See also* Spinal cord compression
- MALT lymphoma, 194–195
- diagnosis of, 195
  - evaluation of, 195
  - genetic types of, 195
  - occurrence of, 195
  - treatment of, 195
- Mammography, 340
- abnormal, 462–463
    - algorithm for, 462f
    - cyst management algorithm, 462
    - for CUP, 563
  - diagnostic v. screening, 462
  - nonpalpable lesion and, 462
- Mantle cell lymphoma, 195–196
- diagnosis of, 195
  - presentation of, 195
  - treatment for, 196
- MAO. *See* Monoamine oxidase inhibitors
- MAP. *See* Mitogen-activated protein
- Marrow damage, hypoproliferative anemia and, 77
- Marrow myelofibrosis, 62f
- Maximal tolerated dose (MTD), 351
- MCFD2. *See* Multiple coagulation factor deficiency 2
- MCH. *See* Mean cell hemoglobin
- MCHC. *See* Mean concentration of hemoglobin per volume of red cells; Mean corpuscular hemoglobin concentration
- McLeod phenotype, 145
- MCV. *See* Mean cell volume; Mean corpuscular volume
- M.D. Anderson Symptom Assessment Inventory, 400
- MDR. *See* Multidrug resistance
- MDS. *See* Myelodysplasia
- M/E ratio. *See* Myeloid/erythroid ratio
- Mean cell hemoglobin (MCH), 12
- Mean cell volume (MCV), 12
- Mean concentration of hemoglobin per volume of red cells (MCHC), 12
- Mean corpuscular hemoglobin concentration (MCHC), 114
- Mean corpuscular volume (MCV), 57
- Mechlorethamine, 329, 354t, 369
- Mechlorethamine, vincristine, procarbazine, and prednisone (MOPP), 203
- Mediastinoscopy, 448
- Medical history, for lymphadenopathy, 32–33
- Mediterranean lymphoma, 487
- Medullary thyroid cancer (MTC), 572, 577
- chemotherapy for, 604
  - management of, 577
  - patient screening for, 603
  - pheochromocytoma and, 613
  - thyroidectomy for, 603, 604
- Medulloblastomas, 552–553
- Megakaryocytes, 161
- Megaloblastic anemia, **95**
- biochemical basis of, 98–99
  - causes of, 95, 95t
  - clinical features of, 99–100
    - cardiovascular disease, 99–100
    - epithelial surfaces, 99
    - malignancy, 100
    - neurologic manifestations, 100
    - NTDs, 99
    - pregnancy complications, 99
  - hematologic findings of, 100–101
    - bone marrow, 100–101, 101f
    - chromosomes, 101
    - hemopoiesis, ineffective, 101
  - not due to cobalamin/folate deficiency, 108
  - diabetes mellitus and, 108
  - peripheral blood smear of, 101f
  - treatment for, 107
- Megaloblastic erythropoiesis, peripheral blood smear of, 65f
- Megestrol, adrenal insufficiency from, 652
- Melanoma, **422**
- “ABCD rules” for, 426
  - acral lentiginous, 423
  - atypical moles v. benign acquired nevi, 426t
  - biopsy of, 426–427
  - clinical characteristics of, 422–423
  - clinical features of, 424t
  - cutaneous precursors for, 427t
  - desmoplastic, 423
  - differential diagnosis of, 426
  - epidemiology of, 422
  - lentigo maligna, 422–423, 423f
  - lifetime risk of, 426
  - management of, 424–426
    - precursor lesions and, 425–426
    - from moles, 426
  - natural history of, 424
  - nodular, 423, 423f
  - pigmented lesions and, 427t
  - prognostic factors for, 423–424
    - 5-year survival rate, 425t
    - anatomic invasion and, 424
    - by staging/thickness, 425t
  - risk factors for, 423t
  - staging for, 425t, 427
  - superficial spreading, 422, 423f
  - treatment for, 427–428
    - adjuvant therapy, 428
    - curative therapy, 428
    - metastatic disease, 428
    - SLNB, 427–428
    - surgical management, 427
- Melphalan, 354t, 390, 428
- for AL amyloidosis, 221
  - for multiple myeloma, 213
  - side effects of, 359

- Memorial Symptom Assessment Scale (MSAS), 399
- MEN. *See* Multiple endocrine neoplasia
- MEN1. *See* Multiple endocrine neoplasia type 1
- MEN-1 gene mutations, 584
- MEN1 development from, 600
- schematic depictions of, 600f
- MEN2. *See* Multiple endocrine neoplasia type 2
- MEN2A. *See* Multiple endocrine neoplasia type 2A
- MEN2B. *See* Multiple endocrine neoplasia type 2B
- Meningeal carcinomatosis, 558
- Meningiomas, 554f
- epidemiology of, 554
- surgery for, 554
- treatment for, 554
- Meningitis. *See also* Neoplastic meningitis
- predisposition for, 380
- presentation of, 380
- Menorrhagia, 26
- Meperidine, 87
- 6-Mercaptopurine, 356t
- Mercaptoethanesulfonate (MESNA), 391
- Merkel cell carcinoma, 431
- MESNA. *See* Mercaptoethanesulfonate
- Metabolic disorders of vessel wall, 233–234
- Metastasis
- bladder cancer treatment and, 507
- bone and, 307, 692, 713
- pain from, 545, 685, 705
- treatment for, 545–546
- of brain, 556–558, 557f
- blood-tumor barrier and, 557
- chemotherapy for, 558
- evaluation of, 557
- frequency of, 557t
- without known primary tumor, 557–558
- radiation therapy for, 558
- radiologic appearance of, 557
- surgery for, 558
- tissue diagnosis needed for, 558
- treatment of, 558
- of breast cancer, 556
- to CNS, 688, 709
- of liver, presence/effect of, 595f
- oncogene signaling pathways for, 308f
- phenotype for, 307
- process of, 307
- prostate cancer as
- castrate, 521
- noncastrate, 519–521
- risk determination/therapeutic strategies for, 307–308
- surgery and, 346
- Methadone, 406
- Methemoglobinemia, 89, 93
- diagnosis/management of, 89–90
- Methotrexate, 19, 108, 356t, 361, 437, 468, 539, 544, 559, 717
- adverse reactions of, 361–362
- clearance/dosage of, 361
- pulmonary damage from, 654
- Methoxypsoralen, 167
- Methylolpa, 122
- Methylene blue, 90, 121
- Methylfolate trap, 99
- Methylmalonic acid (MMA), 100
- Methylphenidate, 409, 410
- Methylprednisolone, 135
- 5-MethylTHF (5-MTHF), 96
- Metoclopramide (Reglan), 329, 369, 407, 593
- Metypapone, 619, 627
- MGUS. *See* Monoclonal gammopathy of uncertain significance
- MI. *See* Myocardial infarction
- Microcytic anemia, diagnosis of, 75f
- Microcytosis, 13
- Microenvironment, of hematopoietic stem cells, 3–4
- Microsatellite, 287
- in normal/tumor tissue, 288f
- Microspherocytes, 686, 706
- Microtubules
- composition of, 362–363
- toxicity of, 363
- Midazolam, 412
- Midline carcinoma of uncertain histogenesis, 529
- Midodrine, for AL amyloidosis, 222
- Minimal residual disease, for CML, 180–181
- Mini-Mental Status Examination, 411
- Mirtazapine, 410, 412
- Mismatch repair (MMR), 307
- Mithramycin, for HHM, 625
- Mitogen-activated protein (MAP), 301
- Mitomycin C, 355t, 360–361, 653
- Mitotane, 364
- mechanism of, 618
- Mitoxantrone, 355t, 361, 659
- for pain palliation, 521
- Mixed lineage leukemia (MLL), 100
- MLL. *See* Mixed lineage leukemia
- MMA. *See* Methylmalonic acid
- MMR. *See* Mismatch repair
- MMS. *See* Mohs micrographic surgery
- MNSsU system, 145
- Modafinil, 409
- Mohs micrographic surgery (MMS), 430
- Monoamine oxidase (MAO) inhibitors, 410
- Monoclonal antibodies
- as colorectal cancer treatment, 485
- to EGFR, 436
- radionuclides/radioimmunotherapy and, 348
- Monoclonal component (M component)
- multiple myeloma and, 211
- nature of, 206
- Monoclonal component (M component) (*Cont.*):
- of serum electrophoresis, 206
- as tumor marker, 206
- Monoclonal gammopathies, 205
- malignant, 638
- Monoclonal gammopathy of uncertain significance (MGUS), 210, 220
- diagnostic criteria for, 210, 210t
- Monocyte/granulocyte disorders
- laboratory diagnosis/management of, 55–56
- oral hygiene and, 56
- types of, 50t
- Monocytes, normal, peripheral blood smear of, 63f
- Monocytoid B cell lymphoma, 199
- Monoferric transferrin, 70
- Mononuclear phagocytes, **53**
- disorders of, 53–54
- viral infections impairment of, 53–54
- MOPP. *See* Mechlorethamine, vincristine, procarbazine, and prednisone
- Morphine, 87, 415
- for pain intervention, 405
- MR. *See* Magnetic resonance
- MRCp. *See* Magnetic resonance cholangiopancreatography
- MSAS. *See* Memorial Symptom Assessment Scale
- MSSC. *See* Malignant spinal cord compression
- MTC. *See* Medullary thyroid cancer
- MTD. *See* Maximal tolerated dose
- 5-MTHF. *See* 5-MethylTHF
- Mu heavy chain disease, **216**
- Mucosa-associated lymphoid tissue lymphoma, 195
- Mucositis, as chemotherapy complication, 370
- Multidrug resistance (MDR), 307
- Multiple coagulation factor deficiency 2 (MCFD2), 240
- Multiple endocrine neoplasia (MEN), **597**
- disease associated with, 597t
- endocrine organs affected by, 597
- screening for, 599
- Multiple endocrine neoplasia type 1 (MEN1), **598**
- adrenal cortical tumors and, 600
- age onset of, 598f
- carcinoid tumors and, 600
- clinical manifestations of, 598–599
- diagnosis of, 704, 730
- enteropancreatic tumors and, 598
- gastrinoma and, 598
- genetic considerations for, 600
- glucagonoma and, 599
- hyperplasia and, 598
- insulinomas and, 599
- manifestations of, 598

- Multiple endocrine neoplasia type (*Cont.*):  
 pituitary tumors and, 599–600  
 treatment for, 600–601  
   hyperparathyroidism, 600–601  
   tumor-suppressor gene for, 598  
 unusual manifestation of, 600
- Multiple endocrine neoplasia type 2  
 (MEN2), **601**, 615f  
 clinical manifestations of, 601  
 genetic considerations for, 602–603  
   naturally occurring, 602  
   uncommon mutations, 602–603  
 pentagastrin test for, 604  
 screening for, 603–604  
 thyroidectomy for, 604  
 treatment for, 603–605
- Multiple endocrine neoplasia type 2A  
 (MEN2A), 601, 612  
 common subvariant of, 602  
 FMTC and, 602  
 pheochromocytoma and, 602
- Multiple endocrine neoplasia type 2B  
 (MEN2B), 612  
 pheochromocytoma and, 602
- Multiple myeloma, **206**  
 in African Americans, 207  
 anemia and, 209  
 bacterial infection susceptibility and, 208  
 bone-related complications and, 214  
 bony lesions in, 207–208, 209f  
 clinical evaluation of, 211  
 clinical features of, 208t  
 definition of, 206–207  
 diagnosis/staging for, 210–211  
   Durie-Salmon staging system, 212t  
 diagnostic criteria for, 210f  
 etiology of, 207  
 extramedullary plasmacytoma and, 210  
 incidence/prevalence of, 207  
 M component and, 211  
 medical emergencies and, 210  
 morphologic features of, 207f  
 pathogenesis/clinical manifestations of,  
 207–210, 209f  
 peripheral blood smear of, 68f  
 plasmapheresis and, 214  
 prognosis of, 211  
 proteasome inhibitors for, 304–305  
 renal disease and, 208  
 solitary bone plasmacytoma and, 210  
 supportive care for, 214  
 treatment for, 212–214  
   chemotherapy, 213  
   standard, 212–213
- Musculoskeletal system  
 dysfunction of, 660  
 infections of, 382  
   diagnosis of, 382  
   treatment of, 382
- Mycobacteria susceptibility, 52t
- Mycosis fungoides  
 evaluation of, 200  
 skin lesion of, 429f  
 treatment of, 200
- Myelin-associated glycoprotein (MAG), 214
- Myelitis, 634
- Myelocyte, 43
- Myelodysplasia (MDS), 128, **138**, 138f, 661
- Myeloid metaplasia, 142
- Myeloid progenitors, 4
- Myeloid/erythroid ratio (M/E ratio), 17
- Myeloma, hematopoietic stem cell  
 transplantation for, 396
- Myeloperoxidase deficiency, 49, 51t
- Myelophthitic anemia, **142**  
 diagnosis of, 142  
 pathophysiology of, 142
- Myelophthisis, 128, 159
- Myelosuppression  
 as chemotherapy complication,  
 366–367  
 complications from, 366  
   *Pneumocystis* and, 367  
 primary prophylaxis from, 367  
 secondary prophylaxis from, 367
- Mylotarg. *See* Gemtuzumab ozogamicin
- Myocardial fibrosis, 659
- Myocardial infarction (MI)  
 abciximab/epitibatide for, 269  
 alteplase for, 281  
 aspirin for, 266  
 streptokinase for, 280
- NADPH. *See* Nicotinamide-adenine  
 dinucleotide phosphate
- NASH. *See* Nonalcoholic steatohepatitis
- Nasopharynx carcinoma, 434  
 TNM staging for, 437t
- National Cancer Institute, 292, 320, 425
- National Center for Biotechnology  
 Information, 292
- National Family Caregivers Association, 413
- National Hospice and Palliative Care  
 Organization, 403
- National Institutes of Health Consensus  
 Conference, 531
- National Institutes of Health Women's Health  
 Initiative, U.S., 333
- National Marrow Donor Program, 309
- National Research Council, 647
- Natural killer (NK), 6, 185
- Nausea  
 cancer supportive care for, 329  
 as chemotherapy complication, 369  
 in palliative/end-of-life care  
 etiology of, 407  
 frequency of, 407  
 intervention for, 407
- NBT. *See* Nitroblue tetrazolium
- N-cadherin, 4
- Neck cancer. *See* Head/neck cancer
- Necrosis, 352
- Negative iron balance, 73
- NEMO. *See* NF- $\kappa$ B essential modulator
- Neoadjuvant therapy  
 prostate cancer and, 517  
 surgery and, 345
- Neobladder, orthotopic, 507
- Neodymium-YAG laser therapy,  
 454–455
- Neonatal jaundice (NNJ), 119
- Neoplastic meningitis  
 development of, 649  
 diagnosis of, 649  
 as oncologic emergency, 648–649  
 sign/symptoms of, 648–649  
 treatment for, 649
- Nervous system dysfunction, 659–660  
 cognitive decline and, 660  
 hearing loss and, 660  
 neurocognitive sequelae from, 660
- NETs. *See* Neuroendocrine tumors
- Neural tube defects (NTDs), 99
- Neurilemmomas, 554
- Neurinomas, 554
- Neurocutaneous syndromes, 555–556  
 NF1 as, 556  
 NF2 as, 556
- Neuroendocrine carcinoma, 566
- Neuroendocrine tumors (NETs), **578**  
 classification/pathology/biology of,  
 578–584  
   area of origin and, 581  
   cytoreduction surgery for, 596  
   gastrointestinal  
     characteristics of, 579t  
     syndromes for, 579–580t  
     tumor location and, 581t  
   general features of, 578

- Neuroendocrine tumors (NETs) (*Cont.*):  
 genetic disorders associated with, 582, 583t  
 incidence of, 582  
 prognosis of, 583t  
 serotonin and, 581  
 survival rate for, 595  
 treatment for, 595–596
- Neurofibromatosis type 1 (NF1), 556, 614f  
 characteristics of, 556  
 gene mutation and, 556, 584  
 pheochromocytoma and, 612  
 risks from, 556
- Neurofibromatosis type 2 (NF2), 555, 556  
 cause of, 556  
 characteristics of, 556
- Neurologic-myopathic syndromes, 444
- Neuromas, 554
- Neutropenia, 47–48  
 causes of, 48t  
 drug induced–, 47  
 hereditary, 48–49  
 as oncologic emergency, 654
- Neutropenic enterocolitis  
 diagnosis of, 655  
 incidence of, 656  
 as oncologic emergency, 655–656, 655f
- Neutrophil(s), **42**  
 abnormalities of, 47–53  
 with function, 49–53  
 hereditary neutropenia, 48–49  
 neutropenia, 47–48  
 neutrophilia, 49  
 deformability of, 46f  
 development stages of, 43f  
 with Döhle bodies, 44f  
 enzymes released by, 46  
 evolution of, 43  
 hypersegmented, 60f  
 marrow release/circulating compartments  
 of, adhesiveness of, 44  
 maturation of, 42–44  
 migration of, 46  
 normal nucleus of, 44f  
 production/recruitment/inflammation  
 events in, 43f  
 schematic distribution of, 45f  
 travel through pulmonary capillary, 46f
- Neutrophil function, abnormal, 49–52  
 adhesion disorders, 49  
 neutrophil granule disorders, 49–50
- Neutrophilia, 49  
 causes of, 49t
- NF1. *See* Neurofibromatosis type 1
- NF2. *See* Neurofibromatosis type 2
- NF- $\kappa$ B essential modulator (NEMO), 52
- NHL. *See* Non-Hodgkin's lymphoma
- Nicotinamide-adenine dinucleotide  
 phosphate (NADPH), 43, 116
- Nilotinib (Tasigna), 180, 364
- Nilutamide, withdrawal response of, 521
- Nitric oxide (NO), 265
- Nitroblue tetrazolium (NBT), 56
- Nitrofurantoin, 705
- Nitrogen mustard, 359
- Nitrosourea, 140, 366
- NK. *See* Natural killer
- NMDA. *See* N-methyl D-aspartate  
 receptor
- N-methyl D-aspartate (NMDA) receptor, 406  
 antibodies to, 633f
- NMSC. *See* Nonmelanoma skin cancer
- NNJ. *See* Neonatal jaundice
- NO. *See* Nitric oxide
- Nodal marginal zone lymphoma, 199
- Nodular lymphocyte-predominant Hodgkin's  
 disease  
 diagnosis of, 203  
 treatment of, 203–204
- Nodular melanoma, 423, 423f
- Noma, 378–379
- Nonalcoholic steatohepatitis (NASH), 490
- Nonbulky retroperitoneal disease, radiation  
 therapy for, 527
- Noncastrate metastatic disease, prostate cancer  
 and, 519–521  
 standard treatment for, 519  
 testosterone-lowering agents for, 519–520
- Nonfunctional pancreatic endocrine tumors  
 (PETs)  
 diagnosis of, 593–594  
 incidence of, 593  
 symptoms of, 593  
 treatment for, 594
- Non-Hodgkin's lymphoma (NHL), 219  
 clinical characteristics of, 193t  
 environmental factors for, 185  
 evaluation of, 190–191  
 frequency increase of, 185  
 histologic classification of, 182–183  
 Hodgkin's disease risk increased for, 660  
 incidence of, 185  
 IPI for, 190t  
 late effects/consequences of, 661  
 skin nodule of, 429f  
 staging evaluation for, 194t
- Nonmelanoma skin cancer (NMSC), **428**,  
 431t  
 clinical presentation of, 429  
 BCC, 429–430  
 SCC, 430  
 etiology of, 429  
 natural history of  
 BCC, 430  
 SCC, 430  
 treatment for, 430–431
- Nonparaneoplastic neurologic disorders,  
 antibody-associated, 635t
- Nonseminoma, of GCTs, 525–526  
 stage I treatment for, 526  
 stage II treatment for, 526–527
- Non-small cell lung cancer (NSCLC), 440  
 adjuvant therapy for, 452–453, 452t  
 bulky stage IIIA treatment for,  
 453–454  
 chemotherapy for, 455  
 disseminated  
 brain metastases and, 454  
 palliative radiation therapy of,  
 454–455  
 plural effusions and, 454  
 symptomatic endobronchial lesions and,  
 454–455  
 symptomatic management of, 454  
 dry stage IIIB treatment for, 454  
 EGFR targeted therapy for, 455  
 metastatic lesions of, 685, 705  
 pathogenesis subsets of, 300  
 resectability/operability of, 449  
 SCLC v., 693, 716  
 stage IA treatment for, 452  
 stage IB/II treatment for, 452–453  
 stage III treatment for, 453  
 stage I/II treatment for, 451–452, 453  
 radiotherapy w/ curative intent,  
 451–452  
 surgery, 451  
 stage IIIA treatment for, 453  
 superior sulcus/Pancoast tumor treatment  
 and, 453  
 T3 N0 disease treatment for, 453  
 TNM International Staging System for,  
 445  
 VEGF targeted therapy for, 455
- Nonsteroidal anti-inflammatory drugs  
 (NSAIDs), 27, 336, 480  
 therapeutic monitoring of, 672–675t
- Normochromic, 57
- NPM1. *See* Nucleophosmin gene
- NSAIDs. *See* Nonsteroidal anti-inflammatory  
 drugs
- NSCLC. *See* Non-small cell lung cancer
- NTDs. *See* Neural tube defects
- Nuclei, 57
- Nucleophosmin gene (NPM1), 168
- Nutrition, cancer supportive care for, 330
- Nutritional iron balance  
 iron absorption and, 72–73  
 maintenance of, 72  
 pregnancy and, 72
- O<sub>2</sub>-hemoglobin dissociation curve, 11
- OAFs. *See* Osteoclast activating factors
- Octreotide, 370, 588, 592, 593, 601, 645
- O<sub>h</sub>. *See* Bombay phenotype
- Okuda staging, for HCC, 492, 492t
- Olanzapine, 405, 411
- Oligodendrogliomas, 551–552, 552f  
 chromosomal translocations of, 552  
 surgical excision of, 552
- OLT<sub>X</sub>. *See* Orthotopic liver transplant

- Oncogenes, 284. *See also RET* proto-oncogene activation mechanism for, 289–291  
 chromosomal rearrangement, 290–291  
 DNA amplification, 290  
 point mutation, 290  
 addiction/synthetic lethality and, 302f, 309–310  
 in cancer, 289, 290t  
 checkpoints of, 296f  
 chromosomal translocations and, 291t  
 dominant activation of, 441–442  
 primary brain tumors and, 549  
 thyroid cancer and, 572–573  
 tumor progression and, 308f
- Oncologic emergencies  
 adrenal insufficiency as, 651–652  
 airway obstruction as, 650, 651f  
 hemoptysis as, 650  
 hemorrhagic cystitis as, 656  
 HSR as, 656  
 human antibody infusion reactions as, 653  
 HUS as, 653–654  
 hypercalcemia as, 651  
 hypoglycemia as, 651  
 intestinal obstruction as, 645  
 intracranial pressure increase as, 648  
 malignant biliary obstruction as, 645–646  
 metabolic, **651**  
 neoplastic meningitis as, 648–649  
 neutropenia/infection as, 654  
 neutropenic enterocolitis as, 655–656, 655f  
 pericardial effusion/tamponade as, 643–644  
 pulmonary infiltrates as, 654–655  
 pulmonary/intracerebral leukocytostasis as, 649–650  
 seizures as, 649  
 SIADH as, 651  
 spinal cord compression as, 646–648  
 structural-obstructive, **648**  
 SVCS as, 642–643, 644f  
 TLS as, 652–653, 653f  
 treatment-related, **652**  
 TTP as, 653  
 urinary obstruction as, 645
- Ondansetron, 329
- Open-lung biopsy, 382
- OPG. *See* Osteoprotegerin
- Opioids  
 addiction to, 406  
 for pain intervention, 405  
 side effects of, 405
- Oposoclonus-myooclonus syndrome, 636–637  
 idiopathic/cancer-related, 636  
 progression of, 636  
 treatment for, 637
- Oral anticoagulants, 276–279  
 new agents for, 279
- Oral cavity carcinomas, 434
- Oral complications, from cancer, 660
- Oral contraceptives, ovarian cancer and, 530
- Oral hygiene, monocyte/granulocyte disorders and, 56
- Oral iron therapy  
 for iron-deficiency anemia, 76  
 preparations for, 76t
- Oral leukoplakia, 334
- Orchiectomy  
 AFP/hCG/LDH levels before/after, 526  
 for seminoma of GCTs, 527
- Orchiopexy, 524
- Orthotopic liver transplant (OLT), 494
- Oseltamivir, 386t
- Osmotic fragility, 114
- Osteoblastic lesions, 545
- Osteoclast activating factors (OAFs), 207–208
- Osteoporosis  
 from heparin, 273  
 from LMWH, 274
- Osteoprotegerin (OPG), 307
- Osteosarcoma, 699, 723  
 as bone sarcoma, 543–544  
 classification of, 543  
 diagnosis of, 544
- Ovarian cancer, **530**, 688, 708  
 age-specific incidence for, 530  
 as asymptomatic, 531  
 CA-125 elevation and, 531  
 cell types of, 530  
 chemotherapy for, 533–534  
 initial/maintenance, 533  
 clinical presentation/differential diagnosis of, 531  
 epithelial tumors and  
 prognostic factors for, 532  
 treatment for, 533  
 etiology/genetics of, 531  
 evaluation of, 531  
 familial cases of, 530  
 germ cell tumors and, 534  
 germline mutation and, 531  
 incidence/epidemiology of, 530–531  
 oral contraceptives and, 530  
 pathology of, 532  
 prognostic factors for, 532–533  
 screening for, 341, 531–532  
 proteomic technologies for, 531–532  
 staging for, 532–533, 533t  
 stromal cell tumors and, 534–535  
 total hysterectomy for, 532  
 treatment for, 533–534  
 cytoreductive surgery, 533  
 randomized trials for, 533  
 ultrasonography for, 531
- Ovarian germ cell tumors, 534  
 fertility and, 534  
 neoplasm classification in, 534
- Ovarian stromal tumors, 534–535  
 growth rate of, 534  
 treatment for, 534–535
- Oxaliplatin, 354t, 485
- Oxcarbazepine, 406, 548
- P system, 145
- P5N. *See* Pyrimidine 5'-Nucleotidase deficiency
- P13K pathway  
 PTEN signal for, 301  
 targeted interruption for, 301
- p53  
 acquired mutation of, 296  
 as genome guardian, 296  
 induction of, 296
- PA. *See* Pernicious anemia
- Packed red blood cells (PRBC), 145
- Paclitaxel, 357t, 437, 467, 507, 533, 536, 577, 656  
 adverse effects of, 363  
 Cremophor-containing vehicle needed for, 363  
 toxicity of, 561
- Paget's disease, 543
- Pain  
 from bone metastasis, 545, 685, 705  
 cancer supportive care for, 328–329  
 castrate metastatic disease management for, 521  
 intervention for, 405–406  
 neuropathic, 404  
 nociceptive, 404  
 in palliative/end-of-life care  
 assessment of, 404  
 etiology of, 404  
 frequency of, 404  
 interventions for, 404–406  
 radiation therapy for, 406  
 visceral, 404  
 WHO approach on, 405
- Painful crises  
 management of, 87–89  
 sickle cell anemia and, 86
- PAIs. *See* Plasminogen activator inhibitors
- Palifermin, 378
- Palliative/end-of-life care, **398**  
 assessment/care planning for, 399–403  
 communication, 400  
 comprehensive assessment, 399–400  
 continuous goal assessment, 400–402  
 cancer and, 331  
 chemotherapy and, 350–351  
 constipation management in, 406–407  
 delirium management in, 410–412  
 depression management in, 409–410  
 domains of, 399  
 dyspnea management in, 407–408  
 epidemiology of, 398–399  
 family caregivers and, 413  
 fatigue management in, 408–409  
 financial burden management in, 412  
 futile care in, 415

- Palliative/end-of-life care (*Cont.*):  
 future directions of, 419  
 goal discernment protocol for, 400  
 hospice/framework for, 399  
 how/where to receive, 419  
 insomnia management in, 412  
 interventions for, 404–414  
   existential needs, 413–414  
   physical symptoms, 404–409  
   psychological symptoms, 409–412  
   social needs, 412–413  
 last hour care of, 416–417  
   patient management during, 418t  
   plan needed for, 417  
 last stage management in, 414–417  
 nausea management in, 407  
 pain management in, 404–406  
 relationship management in, 413  
 surgery for, 346  
 teletherapy for, 348
- Palpation  
 percussion v., 37  
 of spleen, 37
- Pamidronate, 546  
 for HHM, 625
- Pancoast's syndrome, 443
- Pancreatic cancer, **499**  
 clinical features of, 500  
   physical findings, 500  
   presenting features, 500  
 diabetes mellitus and, 499  
 diagnostic procedures of, 500–501  
   high-risk individual surveillance, 502  
   imaging studies, 500, 501f  
   serum markers, 501–502  
   tissue diagnosis/cytology, 501  
 genetic considerations of, 499–500  
 incidence/etiology of, 499  
   epidemiology, 499  
 staging of, 502, 502t  
 survival of, 502  
 treatment of, 502–503  
   adjuvant chemotherapy, 503, 503f  
   advanced, 502  
   operable, 502–503
- Pancreatic cholera, 599
- Pancreatic endocrine tumors (PETs), **589**  
 characteristics of, 579t  
 classification of, 581  
 functional syndromes for, 581  
 incidence of, 582  
 nonfunctional syndromes and, 581,  
 593–594  
 prognosis for, 582  
 treatment for, 589–590  
   strategies for, 389  
 tumor aggressiveness/survival and, 582  
 tumor localization and, 594–595
- Pancreatic islet cell tumors. *See* Islet cell tumors
- Pancreaticoduodenectomy (Whipple procedure), 503
- Pancreatitis, hereditary chronic, 499
- Pancreatitis, severe chronic, 104
- Pancytopenia, differential diagnosis of, 129t
- Panitumumab (Vectibix), 299t, 485
- Pap smear. *See* Papanicolaou smears
- Papanicolaou (Pap) smears  
 ACS recommendation on, 690, 711  
 for cervix cancer screening, 340, 537  
 findings of, 537
- Papillary thyroid cancer (PTC), 571, 573, 575  
 characteristics of, 573  
 staging of, 575
- Paraganglioma syndromes (PGL), 613–614,  
 616f
- Paraneoplastic antineuronal antibodies, 633t
- Paraneoplastic autonomic neuropathy, 638
- Paraneoplastic hematologic syndromes,  
 628–630, 628t  
 eosinophilia as, 629  
 erythrocytosis as, 628  
 granulocytosis as, 629  
 thrombocytosis as, 629  
 thrombophlebitis as, 629–630
- Paraneoplastic hypercalcemia, 594
- Paraneoplastic myelitis, 637
- Paraneoplastic neurologic disorders (PNDs),  
 631, 632t  
 acute necrotizing myopathy, 638  
 antibody-associated, 635t  
 cerebellar degeneration, 636, 686, 706  
 diagnosis/management of, 632  
 dorsal root ganglia and, 632–633  
 encephalomyelitis/encephalitis, 634–636  
 immune-mediated, 632  
 of nerve/muscle, 634  
 opsoclonus-myoclonus syndrome, 636–637  
 pathogenesis of, 631–632  
 peripheral neuropathies, 638  
 prompt tumor control needed for, 632  
 sensory neuronopathy/dorsal root  
 ganglionopathy, 637  
 of spinal cord, 637  
 stiff-person syndrome, 637  
 visual syndromes, 639
- Paraneoplastic spinal cord syndromes, 637  
 paraneoplastic myelitis and, 637  
 presentation of, 637  
 upper/lower motor neuron dysfunction  
 from, 637
- Paraneoplastic syndromes, 443. *See also*  
 Endocrine paraneoplastic syndromes  
 from ectopic hormone production, 624t
- Paraneoplastic visual syndromes, 639
- Paraproteinemias, 205
- Parasites, 57
- Parathormone-related peptide, tumor cell  
 secretion of, 473
- Parathyroid gland removal, 601
- Parathyroid hormone (PTH), 600  
 level measurement for, 604  
 measurement of, 624
- Parathyroid hormone (PTH) gland,  
 translocation of, 623
- Parathyroid hormone-related peptide  
 (PTHrP), 594  
 bone lesions producing, 623  
 production/mechanism of, 623, 692, 713–714
- Parental imprinting, cancer gene expression  
 and, 292
- Parenteral anticoagulants, **269**
- Parenteral direct thrombin inhibitors,  
 275–276
- Parenteral iron therapy  
 dose calculation for, 77  
 infusion of, 77  
 for iron-deficiency anemia, 76–77  
 usage of, 77
- Paroxetine, 327, 410  
 for hot flashes, 660
- Paroxysmal cold hemoglobinuria (PCH), 123
- Paroxysmal nocturnal hemoglobinuria  
 (PNH), 124–126, 131  
 bone marrow failure and, 125  
 clinical features of, 124–125  
   medical seeking feature for, 124  
   natural history of, 124–125  
 complications of, 125  
 diagnosis of, 692, 701, 713, 726  
 differential diagnosis of, 124  
 epidemiology of, 124  
 laboratory investigation/diagnosis of, 125  
 pathophysiology of, 125  
 treatment for, 126  
   anti-C5 antibody and, 126f  
   urine samples from, 124f
- Partial tandem duplication (PTD), 168
- Parvovirus B19, 113, 138f, 151  
 PRCA and, 137, 688, 709
- PCH. *See* Paroxysmal cold hemoglobinuria
- PCNA. *See* Proliferating cell nuclear antigen
- PCR. *See* Polymerase chain reaction
- PDGF. *See* Platelet-derived growth factor
- PDGFR. *See* Platelet-derived growth factor  
 receptor
- PE. *See* Pulmonary embolism
- PECAM. *See* Platelet/endothelial cell  
 adhesion molecule
- PEI. *See* Percutaneous ethanol injection
- Pel-Ebstein fever, 202
- Pelger-Hüet anomaly, 44, 44f  
 peripheral blood smear of, 63f
- Pemetrexed, 357t, 362, 455
- Penicillin, 48, 121–122, 717  
 oral, 40
- Pentagastrin test, side effects of, 604
- Peptic ulcer disease (PUD), gastrinoma and,  
 590
- Percent transferrin saturation, 16

- Percussion  
 palpation *v.*, 37  
 of spleen, 37  
 techniques for, 37
- Percutaneous ethanol injection (PEI), for  
 HCC, 494
- Pericardial effusion, 643–644, 659  
 origin of, 643  
 survival rate for, 643  
 symptoms of, 643  
 treatment for, 644
- Pericardial tamponade, 643–644  
 treatment for, 644
- Pericardiocentesis, 644
- Peripheral blood smear  
 of acanthocytosis, 61f  
 of acute erythroleukemia, 65f  
 of ALL, 66f, 191f  
 of AML, 65f  
 analysis of, 57  
 for anemia, 13, 685, 706  
 of APL, 65f  
 for aplastic anemia, 133  
 of ATL, 66f, 200f  
 of bone marrow  
 aplastic anemia, 64f  
 erythroid hyperplasia, 64f  
 lymphoma in, 64f  
 metastatic cancer, 64f  
 myeloid hyperplasia, 64f  
 of Burkitt's leukemia, 66f, 198f  
 in lymph node, 67f  
 of CHS, 63f  
 of CLL, 66f, 194f  
 of CML, 66f  
 of diffuse large B cell lymphoma,  
 67f, 197f  
 of Döhle body, 63f  
 of elliptocytosis, 61f  
 of erythrophagocytosis, 67f  
 of follicular lymphoma, 67f, 196f  
 of G6PD, 120f  
 of giant platelets, 62f  
 of HE, 114f  
 of Heinz bodies, 62f  
 of Hodgkin's disease, 67f  
 of Howell-Jolly bodies, 14f, 61f  
 of HS, 114f  
 of IMF, 158f  
 of lacunar cell, 67f  
 of macrocytosis, 14f, 59f  
 of megaloblastic anemia, 101f  
 of megaloblastic erythropoiesis, 65f  
 of membrane-cytoskeleton abnormality,  
 114f  
 of multiple myeloma, 68f  
 of myelofibrosis, 14f, 61f  
 normal appearance of, 14f, 59f  
 of basophil, 63f  
 of bone marrow, 17f, 64f
- Peripheral blood smear, normal appearance  
 of (*Cont.*):  
 of eosinophils, 63f  
 of granulocytes, 62f  
 of monocytes, 63f  
 of plasma cell, 68f  
 of Pelger-Hüet anomaly, 63f  
 of polychromatophilia, 59f  
 of red cell fragmentation, 15f  
 of Reed-Sternberg cell variant, 67f  
 of reticulocytes, 15f  
 of ringed sideroblast, 65f  
 of rouleaux formation, 60f  
 of severe iron-deficiency anemia, 14f  
 of Sézary's syndrome, 66f  
 of sickle cell disease, 60f  
 of spherocytosis, 60f  
 of spur cells, 15f  
 of stippled red cells in lead poisoning, 62f  
 of stomatocytosis, 61f  
 of target cells, 14f, 61f  
 of teardrop cells, 61f  
 of thrombocytopenia, 226f  
 of uremia, 15f
- Peripheral nerve hyperexcitability, 638
- Peripheral nervous system metastases,  
 559–560  
 radiation injury/damage *v.*, 560
- Peripheral neuropathies, treatment  
 for, 638
- Peripheral T cell lymphoma, 201–202  
 diagnosis of, 201  
 evaluation of, 201  
 syndromes associated with, 201–202
- Peritoneal carcinomatosis CUP treatment,  
 566
- Pernicious anemia (PA), 102, 694, 717
- Pesticides, 167
- PET. *See* Positron emission tomography
- PETs. *See* Pancreatic endocrine tumors
- Peutz-Jeghers syndrome, 499, 535
- PFS. *See* Progression-free survival
- PGA. *See* Polyglandular autoimmune  
 syndromes
- PGL. *See* Paraganglioma syndromes
- P-glycoprotein (PGP), 307
- PGP. *See* P-glycoprotein
- Ph. *See* Philadelphia chromosome
- PH. *See* Pleckstrin homology domain
- Phagocyte activation  
 defects of, 51t  
 disorders of, 52–53
- Phagocyte function disorders, 51t
- Phakomatoses. *See* Neurocutaneous  
 syndromes
- Phenacetin, 504
- Phenothiazine, 408
- Phenoxybenzamine, 612
- Phenylbutazone, 167
- Phenytoin, 204, 548, 638, 649
- Pheochromocytoma  
 adrenalectomy for, 605  
 associated syndromes with, 612–614, 613t  
 MEN2A/MEN2B, 612  
 MTC, 613  
 NF1, 612  
 VHL, 613  
 catecholamine/metanephrine measurement  
 for, 611  
 clinical features of, 610, 610t  
 clinical presentation of, 609  
 diagnosis of, 610–611, 703, 729  
 biochemical testing for, 610–611, 611t  
 differential diagnosis of, 611  
 imaging for, 611, 611t  
 epidemiology of, 609  
 etiology/pathogenesis of, 609–610  
 genetic screening for, 614–615  
 germ-line mutations and, 609, 614, 617f  
 hypertension and, 610  
 malignant, 612  
 germ-line mutation for, 612  
 histologic criteria for, 612  
 prognosis of, 612  
 treatment for, 612  
 MEN2A/MEN2B and, 602  
 paraganglial system of, 610f  
 in pregnancy, 612  
 screening for, 604  
 treatment for, 605, 611–612, 703,  
 729  
 surgery, 611–612
- Philadelphia chromosome (Ph), 297  
 in CML, 291
- Phlebography, contrast, 258
- Phlebotomy, 90
- Phosphatase with tensin homology (PTEN), 7  
 mutations of, 301  
 P13K pathway signaled by, 301
- Phosphotyrosine binding (PTB), 297
- Photodynamic therapy, as radiation therapy  
 delivery, 348–349
- Physician-assisted suicide, 415–416  
 definitions of, 415t  
 legal aspects of, 416  
 practices of, 416
- Physician's Health Trial, 335
- PIA. *See* Proliferative-inflammatory atrophy
- PIN. *See* Prostatic intraepithelial neoplasia  
 lesions
- Piroxicam, 336
- Pitting, 36
- Pituitary tumors  
 growth hormone production and,  
 599–600  
 MEN1 and, 599–600  
 treatment for, 601  
 transsphenoidal resection, 601
- PIVKA-2. *See* Protein induced by vitamin K  
 absence

- Plasma cell, normal, peripheral blood smear of, 68f
- Plasma cell disorders, **205**  
clinical manifestations of, 205
- Plasma cell dyscrasias, 205
- Plasmapheresis, 713  
multiple myeloma and, 214  
posttransfusion purpura and, 149
- Plasminogen activator inhibitors (PAIs), 25, 280
- Platelet(s), 224–225  
disorders of, **225**  
thrombocytopenia, 225–229  
function disorders of, 231  
inherited/acquired, 231  
function inhibition of, 224  
life span of, 224
- Platelet adhesion, 22, 224–225
- Platelet aggregation, 22  
from aspirin resistance, 266
- Platelet composition, of arterial thrombosis, 264
- Platelet plug formation, 22
- Platelet role, in arterial thrombosis, 265
- Platelet storage pool disorder (SPD), 231
- Platelet-derived growth factor (PDGF), overexpression of, 300–301
- Platelet-derived growth factor receptor (PDGFR), 298  
overexpression of, 300–301
- Platelet/endothelial cell adhesion molecule (PECAM), 46
- Plateletpheresis, 163
- Pleckstrin homology (PH) domain, 301
- Pleomorphic xanthoastrocytoma, 549
- PML. *See* Promyelocytic leukemia
- PNDs. *See* Paraneoplastic neurologic disorders
- PNETs. *See* Primitive neuroectodermal tumors
- Pneumocystis jirovecii* pneumonia, 394
- Pneumocystis* pneumonia, 382  
myelosuppression and, 367
- Pneumonia, 655
- PNH. *See* Paroxysmal nocturnal hemoglobinuria
- POEMS syndrome. *See* Polyneuropathy, organomegaly, endocrinopathy, multiple myeloma and skin changes syndrome
- Poikilocytosis, 13, 57
- Polychromasia, 13
- Polychromatophilia, 57  
peripheral blood smear of, 59f
- Polycystic kidney disease, EPO and, 78
- Polycythemia, **20**  
diagnostic approach to, 20, 21f  
physical examination for, 20  
symptoms of, 20
- Polycythemia vera (PV), 20, **155**, 687, 708  
clinical features of, 155–156
- Polycythemia vera (PV) (*Cont.*):  
complications of, 156–157  
diagnosis of, 156, 695, 718  
etiology of, 155  
treatment for, 157–158
- Polyglandular autoimmune (PGA) syndromes, 605  
diabetes mellitus and, 607  
diagnosis of, 607  
features of, 606f  
treatment for, 607
- type I, 606  
manifestations of, 606  
presentation of, 606
- type II, 606–607  
autoantibodies found in, 606–607  
characteristics for, 606
- Polymerase chain reaction (PCR), 85
- Polyneuropathy, organomegaly, endocrinopathy, multiple myeloma and skin changes (POEMS) syndrome, **215**, 608, 638  
diabetes mellitus and, 215
- Polyp Prevention Trial, 333
- Polypoid adenomas, as benign small intestine tumors, 486
- Polyposis coli, 479
- Polyps  
cancer from, 478  
colonoscopy and, 478  
colorectal cancer and, 478  
from diet, 333  
molecular changes in, 478
- POMC. *See* Proopiomelanocortin gene
- Poorly differentiated carcinoma  
with midline adenopathy, 566
- Positron emission tomography (PET), 190  
for brain tumors, 548  
for CUP, 563  
diagnostic contribution of, 563  
for pheochromocytoma  
diagnosis, 611
- Positron emission tomography with <sup>18</sup>F-fluoro-2deoxyglucose (FDG-PET), 500, 689, 709
- Postpartum hemorrhage, 26
- Postphlebotic syndrome, 253  
prevention of, 262
- Postremission therapy, for AML, 174
- Post-thrombotic syndrome, DVT and, 252
- Posttransfusion purpura, 149  
plasmapheresis and, 149
- Posttransplant relapse, hematopoietic stem cell transplantation for, 396
- PPSC. *See* Primary peritoneal papillary serous carcinoma
- PRBC. *See* Packed red blood cells
- PRCA. *See* Pure red cell aplasia
- Precursor B cell lymphoblastic leukemia/lymphoma, 191  
diagnosis of, 191  
treatment for, 191–192
- Precursor cell B cell neoplasms, 191–192  
precursor B cell lymphoblastic leukemia/lymphoma, 191
- Precursor cell T cell malignancies, 199–200
- Precursor T cell lymphoblastic leukemia/lymphoma, 199–200  
treatment of, 200
- Prednisone, 717  
for AL amyloidosis, 221
- Pregnancy  
aplastic anemia and, 131  
breast mass during, 700, 726  
chemotherapy complication and, 370  
folate deficiency and, 105  
hemoglobin changes in, 13t  
megaloblastic anemia and, 99  
nutritional iron balance and, 72  
pheochromocytoma in, 612  
warfarin during, 260, 278–279
- Premarin, 336
- Pretransfusion testing, 145
- Primaquine, 705
- Primary brain tumors, **548**  
astrocytomas and, 549–551  
CNS lymphomas and, 553–554  
ependymomas as, 552  
etiology of, 548–549  
genetic alterations and, 549  
medulloblastoma as, 552–553  
meningiomas and, 554, 554f  
oligodendrogliomas and, 551–552, 552f  
oncogenes and, 549  
PNET as, 552–553  
prognosis of, 550  
schwannomas and, 554–555, 555f  
tumor-suppressor genes and, 549
- Primary CNS lymphoma, 553–554, 553f  
chemotherapy for, 553  
prognosis of, 553  
surgery for, 553  
survival of, 554  
toxoplasmosis from, 554
- Primary gastric lymphoma, 477  
treatment for, 477  
radiation therapy, 477
- Primary granules, 43
- Primary hyperparathyroidism, 598  
neoplastic changes in, 598  
treatment for, 600–601  
parathyroid gland removal, 601  
thymectomy for, 600
- Primary peritoneal papillary serous carcinoma (PPSC), 566
- Primary systemic amyloidosis, biochemical nature of, 217



- Primitive neuroectodermal tumors (PNETs), 543  
 surgical excision for, 552
- Procabazine, 140, 354t, 359, 366, 654
- Prochlorperazine (Compazine), 329, 369, 407
- Progression-free survival (PFS), 179
- Proliferating cell nuclear antigen (PCNA), 325, 550
- Proliferative-inflammatory atrophy (PIA), 512
- Promyelocyte, 43
- Promyelocytic leukemia (PML), 168. *See also*  
 Acute promyelocytic leukemia
- Proopiomelanocortin (POMC) gene, 626
- Propranolol, 593
- Prophylactic folic acid, 108
- Prophylaxis  
 for infection, 375–376  
 myelosuppression from, 367  
 surgery and, 344
- Prostacyclin, initiation of, 265
- Prostate  
 anatomy/pathology of, 511–512  
 benign disease in, 522  
 diagnostic procedures/treatment for, 522  
 benign/malignant changes in, 511  
 biopsy of, 513, 514  
 clinical states of, 511f  
 periurethral portion of, 511–512
- Prostate cancer, **512**  
 bone-dominant pattern of, 521  
 chemoprevention of, 336  
 as “curable,” 518  
 cure v. cancer control of, 512  
 development of, 512  
 diagnosis/treatment by clinical state of, 512  
 diagnostic evaluation algorithm for, 514f  
 disease continuum of, 512  
 epidemiology of, 512  
 Gleason grading system for, 515  
 impotence and, 516  
 late effects/consequences of, 662  
 neoadjuvant therapy and, 517  
 no cancer diagnosis of, 513–515  
 physical examination, 513  
 prevention, 513  
 PSA, 513–514  
 pathology of, 514–515  
 screening for, 341  
 staging for, TRUS for, 515  
 systemic relapse of, 516  
 TNM staging system for, 515t  
 treatment of, 364, 516–521  
 active surveillance, 518  
 adverse events and, 516  
 brachytherapy, 517–518  
 castrate metastatic disease, 521  
 clinically localized disease, 516  
 external beam radiation therapy, 517  
 noncastrate metastatic disease, 519–521  
 patient concerns of, 516
- Prostate cancer, treatment of (*Cont.*):  
 radiation therapy for, 517  
 radical prostatectomy, 516–517  
 rising PSA, 518–519  
 Whitmore-Jewett staging system for, 515t
- Prostate Cancer Prevention Trial, 341, 513
- Prostatectomy. *See* Radical prostatectomy
- Prostate-specific antigen (PSA), 341  
 blood half-life in, 516  
 criteria for, 513  
 detection strategies based on, 514  
 elevation of, 566  
 levels increase of, 513  
 prostate cancer/no cancer diagnosis by,  
 513–514  
 rising of, 518–519  
 immediate therapy needed for, 519  
 testing offered of, 513
- Prostatic intraepithelial neoplasia (PIN)  
 lesions, 512
- Protein C, 24  
 for DIC, 243  
 resistance to, 691, 712
- Protein induced by vitamin K absence  
 (PIVKA-2), 492
- Protein starvation, hypometabolic state  
 anemia and, 79
- Protein tyrosine phosphatases (PTP), 297
- Prothrombin time (PT), 29  
 abnormal, 235  
 prolongation of, 235
- Prothrombotic abnormalities, venous  
 thrombosis and, 247
- Prussian blue staining, of marrow iron stores,  
 65f
- PSA. *See* Prostate-specific antigen
- Pseudomonas aeruginosa*, 377
- Psychosocial support, for cancer, 330
- PT. *See* Prothrombin time
- PTB. *See* Phosphotyrosine binding
- PTC. *See* Papillary thyroid cancer
- PTD. *See* Partial tandem duplication
- PTEN. *See* Phosphatase with tensin homology
- PTH. *See* Parathyroid hormone
- PTHrP. *See* Parathyroid hormone-related peptide
- PTP. *See* Protein tyrosine phosphatases
- PUD. *See* Peptic ulcer disease
- Pulmonary angiography, 258
- Pulmonary embolism, as PE treatment,  
 262
- Pulmonary embolism (PE), 250  
 anticoagulation for, 259–261  
 complications of, 260  
 duration of, 260–261  
 fondaparinux, 259–260  
 hospital stay during, 260  
 LMWH, 259  
 UFH, 259  
 warfarin, 260  
 circulation maintenance during, 261
- Pulmonary embolism (PE) (*Cont.*):  
 diagnostic imaging needed for, 255f  
 differential diagnosis of, 255t  
 DVT v., 253  
 dyspnea and, 255  
 evaluation for, 699, 724–725  
 fibrinolysis and, 261  
 imaging tests for, 258f  
 integrated diagnostic approach to, 258  
 invasive diagnostic modalities for, 258  
 IVC filters for, 261  
 management of, 259f  
 nonimaging diagnostic modalities for, 256  
 noninvasive imaging modalities for,  
 256–258  
 significance of, 255  
 signs/symptoms of, 250  
 spiral CT for, 250  
 treatment for, 252, 259–262, 699–700, 725  
 controversy regarding, 252  
 with VKA, 251t
- Pulmonary hemorrhage, 650
- Pulmonary infarction, 255
- Pulmonary infections, 380–381  
*Aspergillus* infection as, 381–382  
 chest infiltrates for, 380–381  
 differential diagnosis of, 381t  
 diagnosis of, 382  
 in granulocytopenic patients, 381  
 treatment of, 382
- Pulmonary infiltrates  
 as oncologic emergency, 654–655  
 onset of, 654  
 radiation therapy and, 654
- Pulmonary system  
 dysfunction of, 659  
 physiology of, typical reference values of,  
 682t
- Pulmonary thromboembolism, **253**. *See also*  
 Deep vein thrombosis; Pulmonary  
 embolism; Venous thromboembolism  
 diagnosis of, 254–258  
 clinical evaluation for, 254  
 clinical syndromes and, 255–256  
 emotional support during, 262  
 epidemiology of, 253–254  
 integrated diagnostic approach to, 258  
 invasive diagnostic modalities for, 258  
 contrast phlebography, 258  
 pulmonary angiography, 258  
 nonimaging diagnostic modalities  
 for, 256  
 blood tests for, 256  
 electrocardiogram for, 256  
 elevated cardiac biomarkers, 256  
 noninvasive imaging modalities for,  
 256–258  
 chest CT, 257, 257f  
 chest roentgenography, 257  
 echocardiography, 258

- Pulmonary thromboembolism, noninvasive imaging modalities for (*Cont.*):  
 lung scanning, 257–258  
 MR, 258  
 venous ultrasonography, 256–257  
 pathophysiology for, 254  
 point score methods/diagnosis for, 254, 255t
- Pulmonary thromboendarterectomy, 262
- Pure red cell aplasia (PRCA), 128, **136**, 686, 706  
 classification of, 137t  
 clinical associations/etiology of, 137  
 definition/differential diagnosis of, 136–137  
 parvovirus B19 and, 137, 688, 708  
 treatment of, 137–138
- Purpura fulminans, DIC and, 240
- PV. *See* Polycythemia vera
- Pyrimethamine, 106
- Pyrimidine 5'-Nucleotidase (P5N) deficiency, 121
- Pyruvate kinase deficiency, 116, 117t  
 treatment for, 116
- Quiescence, hematopoietic stem cell self-renewal and, 6
- Quinolone, 384
- RA. *See* Refractory anemia
- Rabbit antithymocyte globulin, 135
- Radiation exposure  
 cataracts from, 660  
 thyroid cancer and, 572, 659
- Radiation necrosis, of CNS, 561
- Radiation pneumonitis, 654
- Radiation therapy, 343, **346**. *See also*  
 Whole-brain radiation therapy  
 for brain metastasis, 558  
 for breast cancer, 467–468  
 breast cancer risk from, 349  
 cancer caused by, 660–661  
 cell killed by, 346  
 for colorectal cancer, 484  
 delivery of, 346, 348–349  
 brachytherapy, 348  
 photodynamic therapy, 348–349  
 radionuclides/radioimmunotherapy, 348  
 teletherapy, 348  
 for disseminated NSCLC, 454  
 dose-response curve for, 346  
 for esophageal cancer, 474  
 exposure to, 346  
 external beam, 517  
 for gastric adenocarcinoma, 476  
 high-grade astrocytoma and, 551  
 injury from, 560f  
 acute, 560  
 early delayed, 560
- Radiation therapy, injury from (*Cont.*):  
 late delayed, 560–561  
 peripheral nervous system metastases v., 560  
 intensity decrease in, 347  
 mammalian cell survival exposure from, 347f  
 mediastinal, 659  
 for nonbulky retroperitoneal disease, 527  
 for pain intervention, 406  
 parameters of, 347  
 physical properties/biologic effects of, 346–348  
 for primary gastric lymphoma, 477  
 for prostate cancer, 517  
 cancer control and, 517  
 recommendation for, 518  
 rising PSA and, 518  
 pulmonary infiltrates and, 654  
 quantitation of, 348  
 for SCLC, 456  
 SI unit for, 348  
 for soft tissue sarcoma, 542–543  
 target volume of, 347  
 for thyroid lymphoma, 577  
 tissue damage from, 347–348  
 toxicity of, 349, 658  
 acute/chronic, 349  
 bone marrow and, 349  
 transit volume of, 348  
 typical course of, 348  
 x-rays/gamma rays as, 347
- Radiation toxicity, 560–561
- Radiation-derived units, 683t
- Radical prostatectomy, 516–517  
 goal of, 516  
 “high risk” definition and, 516  
 techniques for, 516–517
- Radiofrequency ablation (RFA), 494
- Radioimmunoassay (RIA), 591
- Radioiodine treatment  
 indications for, 576  
 iodine 131 ablation for, 576  
 for thyroid cancer, 576
- Radionuclides/radioimmunotherapy  
 monoclonal antibodies and, 348  
 as radiation therapy delivery, 348
- Radiotherapy, 104  
 for carcinoid tumors, 596
- RAEB. *See* Refractory anemia with excess blasts
- RAEB-t. *See* Refractory anemia with excess blasts in transformation
- Random donor (RD), 145
- RAR- $\beta$ . *See* Retinoic acid receptor- $\beta$
- RARS. *See* Refractory anemia with ringed sideroblasts
- Ras protooncogene  
 activation of, 301  
 mutation of, 301
- Rasburicase, 652
- Raynaud's phenomenon, 527, 660
- RCC. *See* Renal cell cancer
- RD. *See* Random donor
- RDW. *See* Red cell volume distribution width
- RE. *See* Reticuloendothelial system
- Reactive lymphocytes, 58
- Rebuck skin window test, 55
- Receptor tyrosine kinases (RTK), 297  
 signaling pathways activated by, 302  
 targeting of, 300–302  
 signaling pathways downstream of, 301–302
- Recombinant thyroid-stimulating hormone (RTSH), 576  
 use of, 576t
- Recombinant tissue-type plasminogen activator (rt-PA), 279
- Rectal carcinoids, 585
- Red blood cells  
 abnormal cells of, 58  
 agglutination of, 60f  
 antibody-mediated immune destruction of, 121, 122f  
 different shapes of, 58  
 examination of, 57  
 group systems/alloantigens for, 144t  
 inclusions of, 57–58  
 indices of, 13t  
 iron content of, 71  
 iron-deficiency anemia v., 59f  
 life span of, 71  
 membrane/cytoskeleton of, 113f  
 metabolism, 112f  
 nucleated characteristic of, 61f  
 rouleaux formation and, 58  
 stippled appearance of, 62f  
 turnover of, 112
- Red cell folate, 107
- Red cell fragmentation, 60f  
 peripheral blood smear of, 15f
- Red cell membrane-cytoskeleton abnormality, 115t  
 peripheral blood smear of, 114f
- Red cell production  
 by erythron, 10  
 physiologic basis of, 10–11  
 by tissue oxygen tension, 11f
- Red cell transfusion  
 as hypoproliferative anemia treatment, 79  
 for iron-deficiency anemia, 76
- Red cell volume distribution width (RDW), 13
- Redox metabolism abnormality, 116–117, 118f
- Reed-Sternberg cell variant, in nodular sclerosing Hodgkin's disease, 67f
- Refractory anemia (RA), 138
- Refractory anemia with excess blasts (RAEB), 139

- Refractory anemia with excess blasts in transformation (RAEB-t), 139
- Refractory anemia with ringed sideroblasts (RARS), 139
- Reglan. *See* Metoclopramide
- Rehabilitation, surgery for, 346
- Relationships, in palliative/end-of-life care, 413
- Renal cell cancer (RCC), 315, **508**  
 clinical presentation of, 509  
 epidemiology of, 508  
 pathology/genetics of, 508–509  
 sign/symptoms of, 509t  
 staging/prognosis of, 509  
 surgery for, 510  
 survival rates for, 510  
 treatment of, 509–510  
   advanced disease, 510  
   localized tumors, 509–510  
   randomized studies on, 510
- Renal disease  
 hypoproliferative anemia and, 77, 78  
 multiple myeloma and, 208
- Renal dysfunction, 659
- Renal function test, reference range of, 679t
- Renal infections, 383
- Renal pelvis carcinoma, 508
- Respiratory syncytial virus (RSV), 382
- RET* proto-oncogene  
 MEN2 and, 602, 603f  
 somatic mutations of, 603
- Reteplase, 282
- Reticulin stain, of marrow myelofibrosis, 62f
- Reticulocyte  
 peripheral blood smear of, 15f  
 premature release of, 16
- Reticulocyte count  
 for anemia, 13, 15–16, 686, 706  
 correction of, 16f  
 for marrow response estimate, 15  
 preparation for, 59f
- Reticulocyte production index,  
 16, 18  
 calculation of, 16t
- Reticuloendothelial (RE) system, 71
- Retinoic acid receptor- $\beta$  (RAR- $\beta$ ), 334
- Retroperitoneal lymph node dissection (RPLND), 526  
 modified bilateral, 528
- Reverse transcriptase polymerase chain reaction (RT-PCR), 171  
 in CUP, 565
- RFA. *See* Radiofrequency ablation
- Rh system, 144
- RIA. *See* Radioimmunoassay
- Ribavirin, 122, 386t
- Right ventricle (RV) dysfunction, 254
- Risk-directed chemotherapy, for testicular cancer, 527–528
- Rituximab, 123, 124, 194, 198, 229, 299t, 477, 636, 637  
 for NHL, 191  
 for TTP, 230  
 for WM, 215
- Rotterdam Symptom Checklist, 399
- Rouleaux formation  
 peripheral blood smear of, 60f  
 red blood cells and, 58
- RPLND. *See* Retroperitoneal lymph node dissection
- RSV. *See* Respiratory syncytial virus
- RTK. *See* Receptor tyrosine kinases
- rt-PA. *See* Recombinant tissue-type plasminogen activator
- RT-PCR. *See* Reverse transcriptase polymerase chain reaction
- RTSH. *See* Recombinant thyroid-stimulating hormone
- Runt-related transcription factor 1 (RUNX1), 166
- RUNX1. *See* Runt-related transcription factor 1
- RV. *See* Right ventricle
- SAGE. *See* Serial analysis of gene expression
- Salazopyrin, 105
- Salivary gland tumors, 434, 438  
*Salmonella*, 382
- Salpingo-oophorectomy, bilateral, 532
- Salvage chemotherapy, 528–529
- SCC. *See* Squamous cell carcinoma
- Schwannomas, 554–555, 555f  
 predisposition to, 555  
 surgery for, 555
- SCLC. *See* Small cell lung carcinoma
- Scopolamine, 415, 416
- Screening. *See also* Cancer screening  
 for bleeding/thrombosis, 29–30  
 for breast cancer, 340, 463  
 for CA-125, 531  
 for cervix cancer, 340, 537  
 colonoscopy as tool for, 481  
 for colorectal cancer, 340, 481–482, 697, 721  
 for endometrial cancer, 341  
 for HCC, 491–492, 493  
 for large-bowel cancer, 481–482  
 for lung cancer, 341, 444–448, 448f  
 for MEN, 599  
 for MEN2, 603–604  
 for MTC, 603  
 for ovarian cancer, 341, 532–533, 533t  
 for pheochromocytoma, 604  
   genetic, 614–615  
 for prostate cancer, 341, 515, 515t  
 for skin cancer, 341
- SCT. *See* Stem cell transplant
- SDAP. *See* Single-donor apheresis platelets
- SDF. *See* Stromal cell-derived growth factor
- Secondary amyloidosis, 217
- Secondary CNS lymphoma  
 common site of, 554  
 treatment for, 554
- Secondary granules, 43
- SEER. *See* Surveillance, Epidemiology, and End Results database
- Seizures. *See also* Epilepsy  
 from brain tumors, 548  
 as oncologic emergency, 649  
 treatment for, 649
- Selection bias, 712
- Selective estrogen receptor modulators (SERMs), 305
- Selective malabsorption of cobalamin with proteinuria, 103
- Selective serotonin reuptake inhibitors (SSRIs), 410
- Selenium, 336
- Self-renewal  
 cancer's similarity with, 7  
 of hematopoietic stem cells, 2, 3f, 5–7  
 capacity of, 5  
 quiescence and, 6  
 relative function hierarchy, 6f  
 importance of, 6  
 limited understanding of, 6  
 stem cell expansion by, 6  
 subpopulation of, 7
- Selig Mann's disease. *See* Alpha heavy chain disease
- Seminoma, of GCTs, 525–526  
 inguinal orchiectomy for, 527  
 stage I/II treatment for, 527
- Senile purpura, 26
- Sensory neuropathy, 637  
 characteristics for, 637  
 treatment for, 637
- Sentinel node biopsy (SLNB), for melanoma, 427
- Serial analysis of gene expression (SAGE), 292
- SERMs. *See* Selective estrogen receptor modulators
- Serotonin  
 biological effects of, 586–587  
 carcinoid syndrome secretion of, 586  
 elevation of, 587  
 NETs and, 581  
 receptor subclass for, 588  
 synthesis/secretion/metabolism of, 582f
- Sertraline, 410
- Serum  $\beta_2$ -microglobulin, 211
- Serum cobalamin, 106
- Serum cortisol, 652, 687, 707
- Serum electrophoresis, 206  
 monoclonal component of, 206  
 patterns of, 206f
- Serum ferritin, 12, 16  
 iron laboratory studies for, 74  
 sex/age function of, 74f

- Serum folate, 107
- Serum iron, 12  
iron laboratory studies for, 74
- Serum methylmalonate, 106
- Serum protein electrophoresis (SPEP), 220
- Serum tumor markers  
for cancer, 327t  
CUP and, 563  
for testicular cancer, 526, 687, 707
- Severe iron-deficiency anemia, peripheral blood smear of, 14f
- Sexual/reproductive dysfunction, 660
- Sézary's syndrome, 200  
peripheral blood smear of, 66f
- Shwachman-Diamond syndrome, 48, 131
- SI. *See* International System unit
- SIADH. *See* Syndrome of inappropriate antidiuretic hormone
- Sickle cell anemia, 87f  
acute chest syndrome and, 86  
clinical manifestations of, 85–86  
gene therapy for, 88  
painful crises and, 86
- Sickle cell disease  
pathophysiology of, 85f  
peripheral blood smear of, 60f
- Sickle cell syndromes, 85–88  
clinical features of, 86f  
clinical heterogeneity of, 86  
diagnosis for, 87  
treatment for, 87–88
- Sickle cell trait, clinical manifestations of, 87
- Sideroblasts, 17, 74  
ringed, 138f  
peripheral blood smear of, 65f
- Sigmoidoscopy, 340, 480
- Signal transduction pathways, cancer cell biology and, 297, 298f
- SIL. *See* Squamous intraepithelial lesion
- Single-donor apheresis platelets (SDAP), 146
- Single-photon emission tomography (SPECT), 548
- Sinus histiocytosis with massive lymphadenopathy, 204
- Skeletal-connective tissue syndromes, 444
- Skin cancer. *See also* Melanoma;  
Nonmelanoma skin cancer  
nonmelanoma cutaneous malignancies and, 431  
prevention of, 431  
screening for, 341
- Skin Cancer Foundation, 425
- Skin necrosis, from warfarin, 278
- SLE. *See* Systemic lupus erythematosus
- SLNB. *See* Sentinel node biopsy
- Small cell lung carcinoma (SCLC), 439, 622  
differentiation pathway for, 623  
encephalomyelitis and, 634  
NCLC v., 693, 716  
staging of, 448–449
- Small cell lung carcinoma (SCLC) (*Cont.*):  
treatment for, 455–456  
chemotherapy, 455–456  
combined-modality chemoradiotherapy, 456  
radiation therapy, 456  
surgery, 456
- Small intestine carcinoids, 584–585
- Small intestine tumors, **485**  
benign types of, 485–486  
adenomas, 485–486  
angiomas, 486  
leiomyomas, 486  
lipomas, 486  
polypoid adenomas, 486  
lymphoma types of, 486–487  
malignant types of, 486  
adenocarcinomas, 486
- Small lymphocytic lymphoma. *See* B cell chronic lymphoid leukemia
- Smudge cells, 58
- Soft tissue sarcoma, **540**  
biopsy of, 541  
classification of  
liposarcoma, 541  
malignant fibrous histiocytoma, 541  
unclassified, 541  
diagnosis of, 541–542  
radiographic evaluation for, 542  
epidemiology of  
environmental factors for, 540  
iatrogenic factors for, 541  
immunologic for, 541  
viruses for, 541  
genetic considerations for, 541  
GISTs and, 541  
IGF produced by, 541  
incidence of, 540  
staging for, 542  
by AJCC, 542t  
treatment for  
adjuvant chemotherapy, 543  
for advanced disease, 543  
radiation therapy, 542–543  
surgery, 542
- Sokal index, for CML, 177
- Solid tumors  
hematopoietic stem cell transplantation for, 396  
targeted therapies for, 366
- Solitary bone plasmacytoma, 210
- Solitary metastatic site, treatment of, 566
- Solitary pulmonary nodule (SPN), 709  
treatment for, 449–450
- Somatostatin, structure/synthetic analogues of, 588f
- Somatostatin receptor scintigraphy (SRS), 594
- Somatostatinoma syndrome  
cause of, 592  
diagnosis of, 592
- Somatostatinoma syndrome (*Cont.*):  
occurrence of, 592  
treatment for, 592
- Sorafenib, 299t, 358t
- Southeast Asian ovalocytosis, 116
- SPD. *See* Platelet storage pool disorder
- Specific granule deficiency, 50, 51t
- Specific granules, 43
- SPECT. *See* Single-photon emission tomography
- SPEP. *See* Serum protein electrophoresis
- Spherocytosis, peripheral blood smear of, 60f
- Spinal cord compression  
damage mechanism for, 646  
initial symptom of, 646  
occurrence of, 646  
as oncologic emergency, 646–648  
pedicle erosion and, 647  
physical examination for, 646  
prognosis of, 646  
rapid progression of, 559  
from solid tumor metastases, 559  
survival and, 648  
treatment for  
laminectomy, 647  
pain management, 647t  
trial for, 647
- Spiral computed tomography (CT), for PE, 250
- Spleen  
absence of, 40  
scanning for enlargement of, 37–38  
structure/function of, 36f  
adaptive functions of, 36  
composition of, 36  
physiologic roles of, 35
- Splenectomy, **38**, 90  
bacterial infection susceptibility increase by, 40  
for CML, 180  
diseases associated with, 40t  
for Hodgkin's disease staging, 38  
HS and, 115  
hyposplenism from, 40  
infections and, 374–375, 702, 728–729  
for ITP, 229  
as leukemia treatment, 39  
unexplained fever and, 40  
vaccinations needed before/after, 40
- Splenic marginal zone lymphoma, 199
- Splenomegaly, **35**, 243, 686, 702, 706, 728  
clinical assessment for, 36–37  
palpation and, 37  
percussion and, 37  
differential diagnosis for, 38  
diseases associated with, 39t  
laboratory assessment for, 38
- SPN. *See* Solitary pulmonary nodule
- Sprycel. *See* Dasatinib
- Spur cells, peripheral blood smear of, 15f

- Squamous cell carcinoma (SCC), 428  
 clinical presentation of, 430  
 esophageal cancer as, 472  
 natural history of, 430  
 presenting as cervical adenopathy, 566  
 skin lesion of, 429f  
 treatment for, 431
- Squamous intraepithelial lesion (SIL), 537
- SQUID. *See* Superconducting quantum interference device
- SRS. *See* Somatostatin receptor scintigraphy
- SSRIs. *See* Selective serotonin reuptake inhibitors
- Staging. *See also* Ann Arbor staging system; Tumor, nodes, metastasis (TNM) staging classification  
 for adrenocortical tumors, 618  
 for bone sarcoma, 544t  
 for breast cancer, 463, 464t, 465t  
 for cancer treatment, by surgery, 345  
 for cervix cancer, 537, 538f  
 for CLL, 189, 189t  
 for colorectal cancer, 482–484, 483f  
 for gastric adenocarcinoma, 476t  
 for GCTs, 525t  
 for GVHD, 392t  
 for gynecologic malignancies, 533t  
 for head/neck cancer, 436t  
 for Hodgkin's disease, 202  
 for melanoma, 425t  
 for nasopharynx carcinoma, 437t  
 for NHL, 194t  
 for NSCLC, 445  
 for ovarian cancer, 532–533, 533t  
 for pancreatic cancer, 502, 502t  
 for PTC, 575  
 for SCLC, 448–449  
 for soft tissue sarcoma, 542, 542t  
 for testicular cancer, 525t  
 for thyroid cancer, 572, 573t  
 for uterine cancer, 536
- Standardized uptake value (SUV), 445
- Stanford V chemotherapy regimen, 203
- Staphylococcus*, 377
- STAT5, 7
- Stem cell integrin, 3
- Stem cell niche, 3  
 location change of, 4
- Stem cell proliferation  
 in bone marrow, 3  
 regulation of, 6
- Stem cell transplant (SCT), 172. *See also* Allogeneic stem cell transplant; Autologous stem cell transplant  
 for AML, 175  
 late effects/consequences of, 661
- Stem cells. *See* Hematopoietic stem cell(s)
- Stereotaxic radiosurgery, 551  
 for increased ICP, 648
- Sternberg-Reed cells, 182
- Stevens-Johnson syndrome, 378
- Stiff-person syndrome  
 antibodies associated with, 637  
 presentation of, 637  
 treatment for, 637
- Stomach tumors. *See* Gastric adenocarcinoma; Gastric sarcoma; Primary gastric lymphoma
- Stomatocytosis, 116  
 peripheral blood smear of, 61f
- Stool analysis, reference range of, 679t
- Streptococcus*, 377
- Streptococcus bovis* bacteremia, as colorectal cancer risk factor, 480
- Streptococcus bovis* endocarditis, 686, 706
- Streptokinase, 280  
 action mechanism of, 280  
 for MI, 280
- Streptozocin, 329
- Streptozotocin, 359, 369
- Stroke prevention, Aggrenox for, 268
- Stromal cell-derived growth factor (SDF)-1 $\alpha$ , 207
- Strontium 89, 468
- Structural hemoglobinopathies, 84, **85**  
 altered synthesis/function and, 89t  
 sickle cell syndromes as, 85–88
- Subcutaneous panniculitis-like T cell lymphoma, 202
- Subependymal giant cell astrocytoma, 549
- Sulfamethoxazole, 705
- Sulindac, 336, 480
- Sun avoidance, cancer prevention and, 334
- Sunitinib (Sutent), 299t, 358t, 477, 487  
 imatinib v., 300
- Superconducting quantum interference device (SQUID), 93
- Superficial spreading melanoma, 422, 423f
- Superficial thrombophlebitis, 249
- Superior vena cava syndrome (SVCS), 443, 642–643  
 causes of, 642  
 central venous catheters and, 643  
 clinical improvement of, 643  
 diagnosis of, 643  
 presentation of, 642  
 radiographs of, 644f  
 signs/symptoms of, 643  
 cardiorespiratory, 643  
 treatment for, 643, 697, 721–722  
 stenting for, 643
- Supportive care, for aplastic anemia patients, 136
- Surgery, 343  
 for adrenocortical tumors, 618  
 atraumatic endoscopic, 612  
 for bladder cancer, 507  
 for brain metastasis, 558
- Surgery (*Cont.*):  
 for cancer prevention, 337, 344  
 as cancer treatment  
 accessibility of, 345  
 for diagnosis, 344–345  
 for palliation, 346  
 for rehabilitation, 346  
 for staging, 345  
 for treatment, 345–346  
 cancer treatment and, 344–346  
 for prophylaxis, 344  
 cytoreductive, 533  
 for intestinal obstruction, 645  
 laparoscopic approach of, 345  
 late effects of, 658  
 limb-sparing approaches of, 542  
 long-term disease-free survival after, 346  
 for meningiomas, 554  
 metastatic disease and, 346  
 neoadjuvant therapy and, 345  
 for NSCLC, 451  
 for pheochromocytoma, 611–612  
 for primary CNS lymphoma, 553  
 for RCC, 510  
 for schwannomas, 555  
 for SCLC, 456  
 for soft tissue sarcoma, 542  
 for testicular cancer, postchemotherapy, 528  
 for thyroid cancer, 575  
 for typhlitis, 380
- Surgical excision  
 for HCC, 494  
 of oligodendrogliomas, 552  
 for PNET, 552  
 for SCLC, 456
- Surveillance, Epidemiology, and End Results (SEER) database, 320
- Sutent. *See* Sunitinib
- SUV. *See* Standardized uptake value
- SVCS. *See* Superior vena cava syndrome
- Sweet's syndrome. *See* Febrile neutrophilic dermatosis
- Symmetric cell division, 3
- Symptom Distress Scale, 400
- Syndrome of inappropriate antidiuretic hormone (SIADH), 625, 651
- Systemic lupus erythematosus (SLE), 33, 123, 228  
 microspherocytes and, 686, 706
- Systemic lytic state, 280
- Systemic therapy, 347  
 as colorectal cancer treatment, 484–485
- T cells  
 autologous manipulation of, 371  
 in cord blood stem cells, 6  
 differentiation from normal to lymphoma, 188t  
 tumor cells attacked by, 371
- TACE. *See* Transarterial chemoembolization

- TAFI. *See* Thrombin-activated fibrinolytic inhibitor
- TA-GVHD. *See* Transfusion-associated graft-versus-host disease
- Tamoxifen, 305, 336, 363, 409, 466, 520, 661  
for breast cancer, 661–662  
side effects of, 469
- Tarceva. *See* Erlotinib
- Target cells, peripheral blood smear of, 14f, 61f
- Targeted agents, action site of, 365f
- Tasigna. *See* Nilotinib
- Taxane, 369, 435, 649
- TC. *See* Transcobalamin
- Teardrop cells, peripheral blood smear of, 61f
- Teletherapy, 346  
for palliative care, 348  
as radiation therapy delivery, 348  
three-dimensional treatment plan and, 348
- Telomerase  
growth limitations bypass of, 297  
inhibition of, 297
- Temozolomide, 354t, 359, 551, 552
- Tenecteplase, 282  
administration of, 282  
half-life of, 282
- Terazosin, 522
- Testicular cancer, **524**. *See also* Germ cell tumors  
back pain from, 525  
clinical presentation of, 524–525  
etiology/genetics and, 524  
extragonadal GCT/midline carcinoma of uncertain histogenesis and, 529  
fertility and, 529  
IGCCCG classification by, 528t  
incidence/epidemiology of, 524  
late effects/consequences of, 662  
pathology of, 525–526  
relapse of, 527  
spermatogenesis after, 529  
staging/treatment of, 525t  
surveillance for, 526  
treatment of, 526–529, 693, 715  
advanced GCT, 527  
postchemotherapy surgery for, 528  
risk-directed chemotherapy, 527–528  
salvage chemotherapy, 528–529  
stage I nonseminoma, 526  
stage II nonseminoma, 526–527  
stage I/II seminoma, 527  
VeIP for, 528  
tumor markers for, 526, 687, 707
- Testis  
lymph node regional draining to, 525  
ultrasonography of, 524–525
- Testosterone-lowering agents, for noncastrate metastatic disease, 519–520
- Tetracycline, 454
- Tetrahydrofolate (THF), 96
- TF. *See* Tissue factor
- TFPI. *See* Tissue factor pathway inhibitor
- Thalassemia syndromes, **90**. *See also*  $\alpha$ -Thalassemia syndromes;  $\beta$ -Thalassemia syndromes  
diagnosis of, 92  
as hemoglobinopathy, 83  
incidence of, 84  
prevention of, 92
- $\alpha$ -Thalassemia syndromes, 91–92, 91t
- $\alpha$ -Thalassemia-1 trait, 91
- $\alpha$ -Thalassemia-2 trait, 91
- $\beta$ -Thalassemia intermedia, 90f, 91
- $\beta$ -Thalassemia major, 91
- $\beta$ -Thalassemia minor, 91
- $\beta$ -Thalassemia syndromes, clinical manifestations of, 90–91  
 $\beta$ -thalassemia intermedia, 90f, 91  
 $\beta$ -thalassemia major, 91  
 $\beta$ -thalassemia minor, 91  
 $\beta$ -thalassemia trait, 91, 156
- Thalassemic hemoglobin variants, **92**  
hemoglobin E, 92–93  
hemoglobin Lepore as, 92  
hemoglobinopathy and, 84  
HPFH, 93
- Thalidomide, 141  
for IME, 160  
for multiple myeloma, 213
- THE. *See* Tetrahydrofolate
- THF starvation, 99
- Thienopyridine  
action mechanism of, 267  
indications for, 267  
resistance to, 267  
side effects of, 267
- Thiethylperazine (Torecan), 369
- 6-Thioguanine, 356t
- Thiotepa, 359, 390
- Thoracoscopic pericardial fenestration, 644
- Thrombin-activated fibrinolytic inhibitor (TAFI), 239
- Thrombocytopenia, 225–229  
from chemotherapy, 367  
drug-induced, 226–227, 227t  
evaluation algorithm for, 227  
heparin-induced, 227–228, 227f  
history/health of patient and, 225  
infection-induced, 225–226  
inherited, 229  
peripheral blood smear of, 226f  
physical examination for, 225
- Thrombocytosis, 231, 628t, 694, 716–717  
as asymptomatic, 629  
treatment not needed for, 629
- Thrombogenesis, coagulation system and, 265f
- Thrombophilia testing, for venous thrombosis, 248
- Thrombophlebitis, 629–630  
clinical manifestation of, 630  
compression ultrasonography for, 630  
diagnosis of, 630  
pathogenesis of, 629  
treatment for, 630
- Thrombopoietin (TPO), 224
- Thrombosis. *See* Bleeding/thrombosis
- Thrombotic thrombocytopenic purpura (TTP), 229–230, 691–692, 712–713  
ADAMTS13 activity and, 230  
as oncologic emergency, 653  
pathogenesis of, 230, 230f  
treatment for, 230
- Thymectomy, for primary hyperparathyroidism treatment, 600
- Thyroid cancer, **571**  
age associated incidence/mortality for, 571f  
anaplastic, 577  
classification of, 572  
gene mutations/alterations in, 573, 574t  
incidence of, 571  
medullary, 577  
neoplasm classification of, 572t  
pathogenesis/genetic basis for, 572–573  
oncogenes/tumor-suppressor genes, 572–573  
radiation exposure, 572, 659  
TSH/growth factors, 572  
risk factors for, 572t  
staging of, 572, 573t  
survival rates of, 575f  
thyroid lymphoma as, 577  
treatment for, 575–577  
lobectomy, 575  
radioiodine treatment, 576  
RTSH follow-up for, 576, 576f  
thyroidectomy, 575  
TSH suppression therapy, 575  
whole-body scanning follow-up, 576–577  
well-differentiated, 573–577  
papillary, 573, 575  
treatment of, 575–577
- Thyroid lymphoma, 577  
radiation therapy for, 577
- Thyroid nodule, 704, 729–730  
clinical studies on, 570  
evaluation approach to, 570  
FNA biopsy for, 570  
nondiagnostic biopsies for, 571  
patient approach and, 570–571  
algorithm for, 571f  
prevalence of, 570
- Thyroid stimulating hormone (TSH), 572  
frequent measurement needed for, 659  
mutation activation of, 573  
suppression therapy for, 575
- Thyroid transcription factor 1 (TTF-1), 564

- Thyroidectomy  
 for MEN2, 604  
 for MTC, 604  
 MTC death prevention by, 603  
 for thyroid cancer, 575
- Thyrotropin, 203
- TIA. *See* Transient ischemic attack
- TIBC. *See* Total iron-binding capacity
- Ticlopidine  
 indications for, 267  
 side effects of, 267
- Tinzaparin, 259
- TIO. *See* Tumor-induced osteomalacia
- Tipifarnib, 649
- Tirofiban, 268–269, 269t
- Tissue factor (TF), 23  
 coagulation initiated by, 23f
- Tissue factor pathway inhibitor (TFPI), 25  
 from heparin, 270
- TLS. *See* Tumor lysis syndrome
- TMP-SMX. *See* Trimethoprim-sulfamethoxazole
- TNF- $\alpha$ . *See* Tumor necrosis factor  $\alpha$
- TNM. *See* Tumor, nodes, metastasis staging classification
- Tobacco use, 693, 715–716. *See also* Cigarette smoking  
 as colorectal cancer risk factor, 480–481
- $\alpha$ -Tocopherol/ $\beta$ -carotene (ATBC) Lung Cancer Prevention Trial, 335
- Tonsillectomy, bleeding/thrombosis and, 26–27
- Topoisomerase II inhibitor-associated leukemia, 167
- Topoisomerase poisons, 360–361
- Topotecan, 355t, 361, 534
- Torecan. *See* Thiethylperazine
- Total iron-binding capacity (TIBC), 12, 73  
 iron laboratory studies as, 74
- Toxic granulations, 44
- Toxoplasmosis, from primary CNS lymphoma, 554
- TP53. *See* Tumor protein p53
- TPO. *See* Thrombopoietin
- Trace minerals, reference range of, 675t
- Tranexamic acid, 233, 238, 243
- Transaminase, level elevation of, 273
- Transarterial chemoembolization (TACE), 494  
 randomized trials involving, 495t
- Transcobalamin (TC), 96
- Transferrin  
 diferric, 70  
 monoferric, 70
- Transferrin receptor protein (TRP), 75
- Transferrin receptors, 71
- Transfusion biology/therapy, **143**  
 adverse reactions to, **147**  
 electrolyte toxicity, 150  
 fluid overload, 150
- Transfusion biology/therapy, adverse reactions to (*Cont.*):  
 hypotensive reactions, 150  
 hypothermia, 150  
 immunomodulation, 150  
 iron overload, 150  
 alternatives to, **151**  
 blood components for, 145–147  
 characteristics of, 146t  
 cryoprecipitate, 147  
 FFP, 147  
 plasma derivatives, 147  
 platelets, 146–147  
 PRBC, 146  
 whole blood, 146  
 blood group antigens/antibodies for  
 ABO antigens/antibodies, 143–144  
 alloantibodies, 144–145  
 Rh system, 144  
 complication risk of, 148t  
 immune-mediated reactions to, **147**  
 acute hemolytic transfusion reactions, 147–148  
 acute lung injury related to, 149  
 allergic reactions, 148–149  
 alloimmunization, 149–150  
 anaphylactic reactions, 149  
 DHTR/serologic reactions, 148  
 FNHTR, 148  
 GVHD, 149  
 posttransfusion purpura, 149  
 infectious complications in, 150–151  
 bacterial, 151  
 viral, 150–151  
 pretransfusion testing for, 145  
 Transfusional hemosiderosis, treatment for, 93  
 Transfusion-associated graft-versus-host disease (TA-GVHD), 131, 149  
 Transient ischemic attack (TIA), 155  
 Aggrenox for, 267  
 Transrectal ultrasound (TRUS), 513  
 for prostate cancer staging, 515  
 Transsphenoidal resection, 601  
 Transurethral ultrasound-guided laser-induced prostatectomy (TULIP), 522  
 Trastuzumab (Herceptin), 299t, 300, 372, 467, 656, 659  
 Trazodone, 410  
 Tretinoin, 358t  
 Triamterene, 105  
 Trimethoprim-sulfamethoxazole (TMP-SMX), 47, 56, 381, 382, 393, 694, 708, 717  
 Tropical sprue, 103  
 Trousseau's syndrome, 629  
 TRP. *See* Transferrin receptor protein  
 TRUS. *See* Transrectal ultrasound  
 TSH. *See* Thyroid stimulating hormone  
 TTF-1. *See* Thyroid transcription factor 1
- TTP. *See* Thrombotic thrombocytopenic purpura
- Tuberous sclerosis (Bourneville's disease), 556, 584  
 mutations causing, 584
- TULIP. *See* Transurethral ultrasound-guided laser-induced prostatectomy
- Tumor(s). *See also* Germ cell tumors  
 adrenal cortical, 600  
 biopsy of, 345  
 causing biliary obstruction, 646  
 cell cycle progression and, 344  
 clear cell, 508  
 endolymphatic sac, 613  
 Gompertzian growth curve for, 344t  
 hormonal response of, 364  
 immune system avoidance by, 371  
 islet cell, 581, 599, 601  
 localization of, 594–595  
 localized RCC treatment for, 509–510  
 “organ-like” behavior of, 343–344  
 radiation therapy damage to, 347–348  
 success/growth of, 344  
 vaccinations for, 371  
 vascular/lymphatic spreading of, 345  
 Tumor, nodes, metastasis (TNM) staging classification, 325, 463  
 for bladder cancer, 504, 505f  
 of breast cancer, 464t  
 for head/neck cancer, 435, 436t  
 for lung cancer, 446t  
 of nasopharynx carcinoma, 437t  
 for prostate cancer, 515t  
 for thyroid cancer, 572, 573t  
 Tumor angiogenesis, **310**, 311f, 344  
 angiogenic switch and, 310  
 cancer treatment from understanding of, 314  
 host molecules for, 314  
 hypoxia and, 311  
 stimuli for, 310  
 therapeutic approach from, 316f  
 tumor vessel formation mechanism of, 310–314  
 vasculogenesis and, 312, 314  
 VEGF and, 311–312  
 Tumor cells  
 apoptosis evolution of, 305  
 apoptosis resistance from, 307  
 biological features of, 325  
 chromosomal instability in, 292  
 formation of, 286f  
 parathormone-related peptide secreted from, 473  
 progression of, 308f  
 T cells attack of, 371  
 Tumor lysis syndrome (TLS), 699, 724  
 Burkitt's lymphoma and, 652  
 diagnosis of, 700, 725  
 hyperuricemia and, 652

- Tumor lysis syndrome (TLS) (*Cont.*):  
 management of, 653f  
 occurrence of, 652  
 as oncologic emergency, 652–653  
 treatment for, 652–653  
 urine output and, 652
- Tumor necrosis factor  $\alpha$  (TNF- $\alpha$ ), 44
- Tumor protein p53 (TP53), 166
- Tumor vessels  
 blood vessels *v.*, 310  
 lymphatic cells within, 314  
 sprouting of, 311  
 therapeutic blocking approach to, 316f  
 tumor angiogenesis and, 310–314  
 vascular lining of, 310  
 VEGF signaling and, 313f
- Tumor-induced osteomalacia (TIO). *See*  
 Hypophosphatemic oncogenic  
 osteomalacia
- Tumors metastatic to bone, **545**
- Tumor-suppressor genes, 284  
 inactivation of, 442  
 mechanisms of, 286  
 for MEN1, 598  
 point mutations/large deletions and, 286  
 primary brain tumors and, 549  
 thyroid cancer and, 572–573
- Turbot's syndrome, 479
- Typhlitis  
 physical examination for, 380  
 surgery for, 380  
 treatment for, 380
- UFH. *See* Unfractionated heparin
- Ultrasonography  
 compression, for DVT, 250  
 for lymphadenopathy, 34–35  
 for ovarian cancer, 531  
 of testis, 524–525
- Umbilical cord blood  
 allogeneic stem cell transplant and, 178  
 hematopoietic stem cell supplied by, 6  
 hematopoietic stem cell transplantation use  
 of, 388, 390
- Unfractionated heparin (UFH), 227,  
 259, 262
- United Network for Organ Sharing  
 (UNOS), 494
- UNOS. *See* United Network for Organ Sharing
- Unstable hemoglobin variants,  
 diagnosis/management of, 89–90
- UPEP. *See* Urine protein electrophoresis
- Uremia, peripheral blood smear of, 15f
- Ureter carcinoma, 508
- Ureteral infections, 383
- Urinary 5HIAA levels, for carcinoid  
 tumors/syndrome diagnosis, 587
- Urinary obstruction  
 etiology of, 645  
 as oncologic emergency, 645
- Urinary obstruction (*Cont.*):  
 symptoms of, 645  
 treatment for, 645
- Urine analysis, reference range of, 677–678t
- Urine protein electrophoresis (UPEP), 220
- Urokinase, 281
- U.S. Prevention Services Task Force  
 (USPSTF), 339
- USPSTF. *See* U.S. Prevention Services Task  
 Force
- Uterine cancer, **535**  
 chemotherapy for, 536  
 clinical presentation of, 535  
 genetics and, 535  
 incidence/epidemiology of, 535  
 pathology of, 535–536  
 staging for, 536  
 survival rates for, 536  
 treatment for, 536
- Vaccinations  
 of cancer patients, 387  
 chemoprevention for, 337  
 chemotherapy indication for, 376t  
 with influenza vaccine, 385  
 needed before/after splenectomy, 40  
 for tumors, 371
- Valacyclovir, for herpes viruses, 385t
- Valganciclovir, for herpes viruses, 385t
- Valproic acid, 548
- Vancomycin, for AML, 173
- Vascular endothelial growth factor (VEGF), 46  
 bevacizumab inhibiting, 317  
 inhibited signaling of, 313f  
 targeted therapy for, 455  
 tumor angiogenesis and, 311–312  
 tumor cell-derived, 314
- Vascular instability, from anemia, 11
- Vasculitis, of nerve/muscle, 638
- Vasculogenesis, tumor angiogenesis and, 312,  
 314
- Vasoactive intestinal peptide (VIP), 599
- Vasoocclusion, 85–86
- VATS. *See* Video-assisted thoracic surgery
- Vectibix. *See* Panitumumab
- VEGF. *See* Vascular endothelial growth factor
- VeIP. *See* Cisplatin, ifosfamide, and vinblastine
- Venlafaxine, 410
- Venoocclusive disease, 391
- Venous thromboembolism (VTE), 253  
 alveolar hyperventilation and, 254  
 anticoagulation of, 259t  
 decreased pulmonary compliance and,  
 254  
 education on, 253  
 epidemiology of, 253–254  
 fondaparinux for, 275  
 genetic/acquired factors contributing to,  
 253–254  
 impaired gas exchange and, 254
- Venous thromboembolism (VTE) (*Cont.*):  
 increased airway resistance and, 254  
 increased pulmonary vascular resistance  
 and, 254  
 pathophysiology for, 254  
 embolization, 254  
 physiology, 254  
 RV dysfunction, 254  
 prevention of, 262, 262t
- Venous thrombosis, **246**  
 arterial thrombosis *v.*, 264  
 diagnosis of, 249–250  
 clinical decision rule for, 250t  
 DVT, 249–250  
 PE, 250  
 epidemiology of, 246  
 etiology of, 246–247  
 global data on, 249  
 hereditary thrombophilia and, 248–249  
 prevention for, 248  
 thrombophilia testing for, 248  
 prognosis of, 247–248  
 prothrombotic abnormalities and, 247  
 rare sites of, 249  
 risk factors for, 246, 247t  
 acquired/genetic, 247  
 models of, 248f  
 superficial thrombophlebitis and, 249  
 symptoms of, 246  
 treatment for, 251–252
- Venous ultrasonography  
 of deep leg veins, 256t  
 of DVT, 257f  
 for pulmonary thromboembolism,  
 256–257
- Verner-Morrison syndrome, 599. *See also*  
 VIPomas
- Vessel wall, 225  
 disorder of, 233–234  
 inherited, 234  
 metabolic/inflammatory, 233–234  
 function of, 225
- VGCCs. *See* Voltage-gated calcium channels
- VGKCs. *See* Voltage-gated potassium channels
- VHL. *See* von Hippel-Lindau syndrome
- Vidarabine, 47
- Video-assisted thoracic surgery  
 (VATS), 451
- Vinblastine, 357t, 363, 539
- Vincristine, 357t, 409, 545, 659  
 toxicity of, 561  
 for TTP, 230
- Vinorelbine, 357t
- VIP. *See* Vasoactive intestinal peptide
- VIPomas, 592–593, 703, 729  
 symptoms of, 593
- Vision dysfunction, 660
- Visual Analogue Scale, 404
- Visual syndromes, paraneoplastic, 639
- Vitamin B<sub>12</sub>. *See* Cobalamin



- Vitamin K  
 as coagulation cofactor, 685, 705  
 cycle of, 240f  
 metabolism/regeneration of, 240
- Vitamin K antagonists (VKA), 276  
 as DVT/PE treatment, 251t
- Vitamin K deficiency, 243, 685, 705  
 dysfibrinogenemia and, 243  
 nutritional intake and, 243
- Vitamin K epoxide reductase (VKOR), 276
- Vitamins, reference range of, 675t
- Vitiligo, 606
- VKA. *See* Vitamin K antagonists
- VKOR. *See* Vitamin K epoxide reductase
- Voltage-gated calcium channels (VGCCs), 631
- Voltage-gated potassium channels (VGKCs), 631
- Vomiting  
 as chemotherapy complication, 369  
 emesis and, 369
- von Hippel-Lindau syndrome (VHL), 499, 556, 584, 602  
 cause of, 605  
 extraparaganglial features of, 616f  
 pheochromocytoma and, 613  
 tumor-suppressor protein of, 310
- von Recklinghausen's disease, 584. *See also* Neurofibromatosis type 1
- von Willebrand disease (vWD), 231–233  
 classification of, 232  
 functional defects of, 232  
 laboratory diagnosis of, 232t
- von Willebrand factor (vWF), 22, 147, 224  
 GPIIb/IIIa receptor antagonists and, 268
- Voriconazole  
 for AML, 173  
 amphotericin B v., 384
- Vorinostat, 365
- VTE. *See* Venous thromboembolism
- vWD. *See* von Willebrand disease
- vWF. *See* von Willebrand factor
- Waldenström macroglobulinemia (WM), 124, 199, 214, 219, 608, 638  
 bone marrow and, 214  
 cause of, 214  
 clinical manifestation of, 214  
 treatment for, 215
- Waldeyer's ring involvement, 196
- Warburg, Otto, 284
- Warfarin, 243, 251, 262, 276–289, 630, 689, 710  
 action mechanism of, 276–277, 277f, 692, 714  
 antithrombotic effect of, 277  
 dosing of, 260, 278  
 for HIT, 228  
 INR for, 277  
 monitoring of, 277–278  
 pharmacology of, 277  
 factors influencing, 277  
 during pregnancy, 260  
 side effects of, 278–279  
 bleeding, 278  
 pregnancy, 278–279  
 skin necrosis, 278  
 special problems of, 279
- Warts, hypogammaglobulinemia, infections, and myelokathexis (WHIM), 44
- Watery diarrhea syndrome, 599
- WBC. *See* White blood count
- WBRT. *See* Whole-brain radiation therapy
- West Nile Virus (WNV), 151
- WHIM. *See* Warts, hypogammaglobulinemia, infections, and myelokathexis
- Whipple procedure. *See* Pancreaticoduodenectomy
- White blood count (WBC), 42
- Whitmore-Jewett staging system, for prostate cancer, 515t
- WHO. *See* World Health Organization
- Whole-brain radiation therapy (WBRT), 553, 558
- Wilms' tumor gene-1 (WT-1), 565
- Wiskott-Aldrich syndrome, 229, 394
- WM. *See* Waldenström macroglobulinemia
- WNV. *See* West Nile Virus
- Wolfram's syndrome, 607
- World Health Organization (WHO)  
 AML classification by, 167, 167t  
 clinical features/relevance, 167–168  
 genetic findings/relevance, 168  
 anemia definition of, 11  
 astrocytoma grading system by, 549  
 GI NETs classification by, 582  
 lung cancer classification by, 439  
 lymphoid malignancy classification by, 182–184, 183t  
 MDS classification by, 139t  
 pain intervention approach by, 405
- Worthing Chemotherapy Questionnaire, 399
- Wright-Giemsa stain, 13, 14f. *See also* Peripheral blood smear
- WT-1. *See* Wilms' tumor gene-1
- X-rays, 347. *See also* Chest x-ray
- Xylocaine, 454
- Zanamivir, 386t
- ZES. *See* Zollinger-Ellison syndrome
- Zidovudine, 47
- Zollinger-Ellison syndrome (ZES), 104  
 cause of, 598  
 diagnosis of, 598–599  
 symptoms of, 598  
 treatment of, 601
- Zolpidem, 412